

DENTAL INSTRUMENTS CATALOG

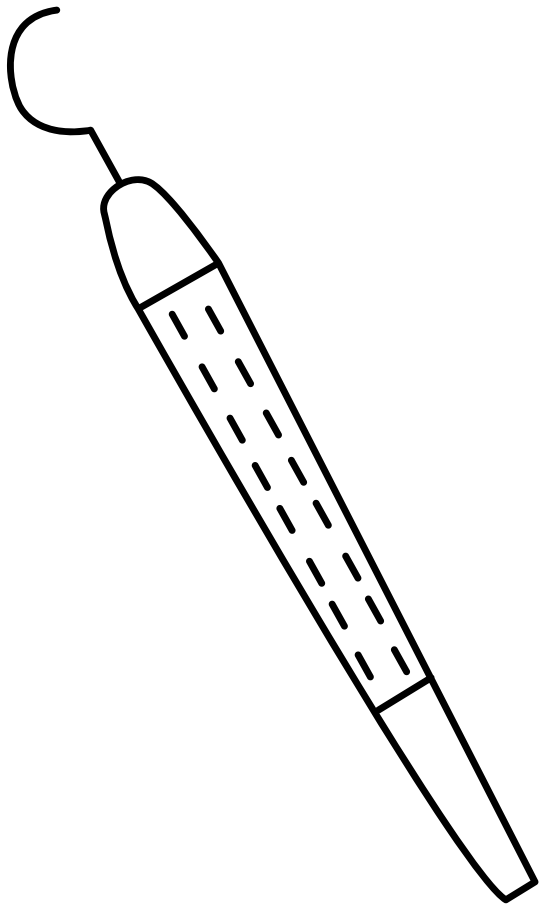

CONTENU

EXTRACTION

Daviers.....	05
Pinces Gouges.....	25
Élévateurs.....	29

CHIRURGIE

Bistouris.....	45
Ciseaux.....	48
Pinces à Dissection.....	56
Pinces Hémostatiques.....	60
Curettes Osseuses / Rugines.....	62
Burins / Gouges / Maillets.....	70
Implantologie.....	76
Ecarteurs / Ouvre-Bouches.....	81
Porte-Aiguilles.....	87
Accessoires.....	91

DIAGNOSTIC

Miroirs à Bouche.....	96
Précèlles.....	98
Sondes.....	102

PARODONTOLOGIE

Instruments à Détrarrter.....	110
Curettes.....	115
Gingivectomie.....	125

DENTISTERIE CONSERVATRICE

Ciseaux à Email / Finsseurs à Bords Gingivaux.....	130
Excavateurs.....	132
Porte-Matrices et Matrices.....	137
Porte-Amalgames.....	138
Instruments pour Obturations.....	140
Instruments pour Composite.....	149
Instruments à Modeler.....	151
Spatulas à Ciment.....	159
Instruments pour Digue de Caoutchouc.....	160
Endodontie.....	162

PROTHÈSE / ORTHODONTIE

Instruments à Modeler.....	168
Couteaux / Spatulas.....	172
Instruments à Couronnes.....	176
Porte-Empreintes.....	184
Pinces.....	192

Index Alphabétique.....	208
-------------------------	-----

Index Numérique.....	224
----------------------	-----

CONTENIDO

EXTRACCIÓN

Forceps.....	
Pinzas Gubias.....	
Botadores.....	

CIRUGÍA

Bisturios.....	
Tijeras.....	
Pinzas de Disección.....	
Pinzas Hemostáticas.....	
Curetas Óseas / Periostotomos.....	
Cinceles / Martillos.....	
Implantología.....	
Separadores / Abre-Bocas.....	
Porta-Agujas.....	
Accesorios.....	

DIAGNÓSTICO

Espejos de Boca.....	
Pinzas.....	
Sondas.....	

PERIODONCIA

Limpiaadores de Sarro.....	
Curetas.....	
Gingivectomia.....	

ODONTOLOGÍA DE CONSERVACIÓN

Cinceles para Esmalte / Recortadores del Margen Gingival.....	
Excavadores.....	
Portamatrices y Matrices.....	
Porta Amalgamas.....	
Instrumentos para Obturaciones.....	
Instrumentos para Composite.....	
Instrumentos para Modelar.....	
Espátulas para Cemento.....	
Instrumentos para Dique de Goma.....	
Endodoncia.....	

PROSTODONCIA / ORTODONCIA

Instrumentos para Modelar.....	
Cuchillos / Espátulas.....	
Instrumentos para Coronas.....	
Cubetas de Impresiones.....	
Pinzas.....	

Índice Alfabético.....	
------------------------	--

Índice Numérico.....	
----------------------	--



36

EXTRACTION
EXTRAKTION
EXTRACTION
EXTRACCIÓN

www.healerm instruments.com
sales@healerm instruments.com
phone: +923034515151

Karogriff
 Handle with diamond profile
 Manche à carreaux
 Mango con forma de diamante

36



36.100-1



11-13,21 - 23



36.100-2



11-13,21 - 23

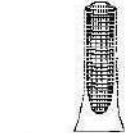

36.150-1

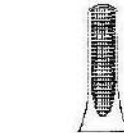

36.150-2



36.100-7



14 -15,24 -25

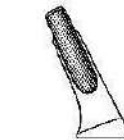

36.110-7



14 -15,24 -25



36.150-7

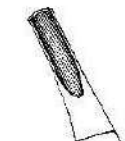

36.101-36 GUY



14 -15,24 -25

Karogriff
 Handle with diamond profile
 Manche à carreaux
 Mango con forma de diamante

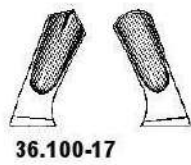

36.100-17



16-18

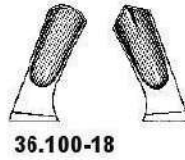

36.100-18



26-28

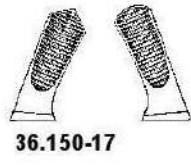

36.150-17

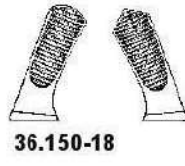

36.150-18

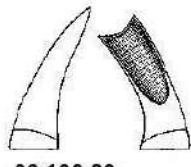

36.100-89



16-18

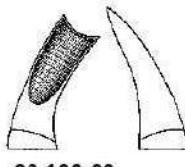

36.100-90



26-28

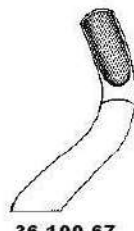

36.100-67



18,28



36.100-67A



18,28



36.150-67



36.150-67A

Karogriff
 Handle with diamond profile
 Manche à carreaux
 Mango con forma de diamante

36

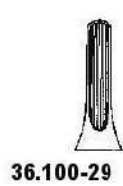

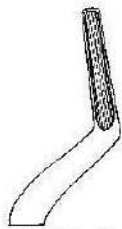

36.100-51

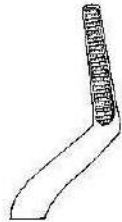

36.150-51



Wurzeln · roots
 racines · raíces



36.100-51F



Wurzeln · roots
 racines · raíces

Karogriff
 Handle with diamond profile
 Manche à carreaux
 Mango con forma de diamante



36



36.100-51A



36.150-51A



Wurzeln · roots
 racines · raíces

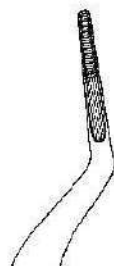

36.100-51C



Wurzeln · roots
 racines · raíces

Karogriff

Handle with diamond profile

Manche à carreaux

Mango con forma de diamante



36.100-4



36.150-4



31-33, 41-43

36



36.100-13



36.150-13



34-35, 44-45



36.110-13



34-35, 44-45



36.100-75



36.150-75



34-35, 44-45

Karogriff
 Handle with diamond profile
 Manche à carreaux
 Mango con forma de diamante

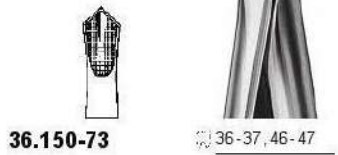
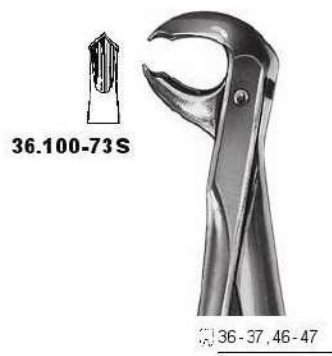

36

Karogriff
 Handle with diamond profile
 Manche à carreaux
 Mango con forma de diamante

36

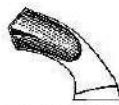

36.100-21



36-37, 46-47



36.100-87

36-37, 46-47

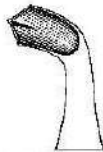

36.100-79



38, 48



36.100-79A



38, 48



36.150-79



36.228L

Routurier



38



36.228R

Routurier



48

Karogriff
 Handle with diamond profile
 Manche à carreaux
 Mango con forma de diamante

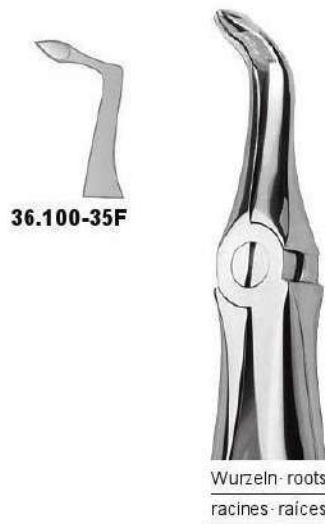

36



Anatomischer Griff
 Anatomic handle
 Manche anatomique
 Mango anatómico



diamantiert, diamond coating, couche de diamant, capa de diamante

36

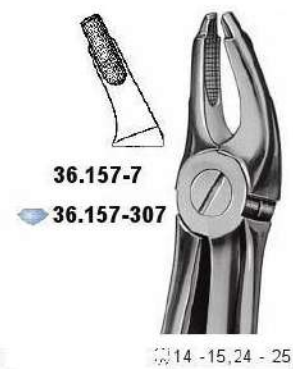
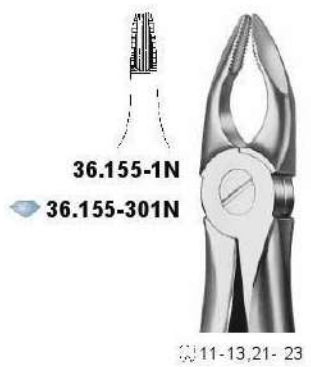
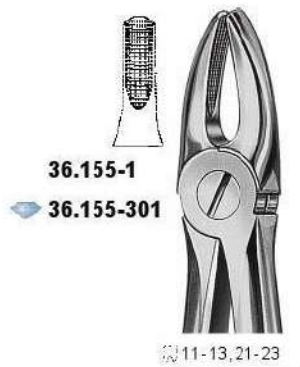

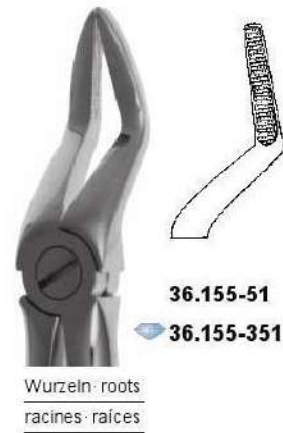

Anatomischer Griff
 Anatomic handle
 Manche anatomique
 Mango anatómico



diamantiert, diamond coating, couche de diamant, capa de diamante



36



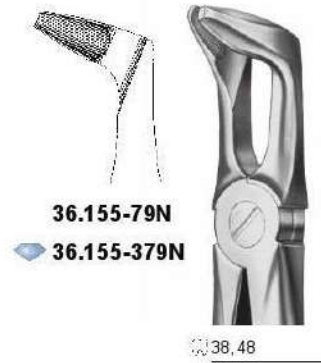



diamantiert, diamond coating, couche de diamant, capa de diamante

36

36.171 STIEGLITZ
 Wurzelfragmente
 Root fragments
 Fragments de racines
 Fragmentos de raíces

36.175
 Wurzelfragmente
 Root fragments
 Fragments de racines
 Fragmentos de raíces

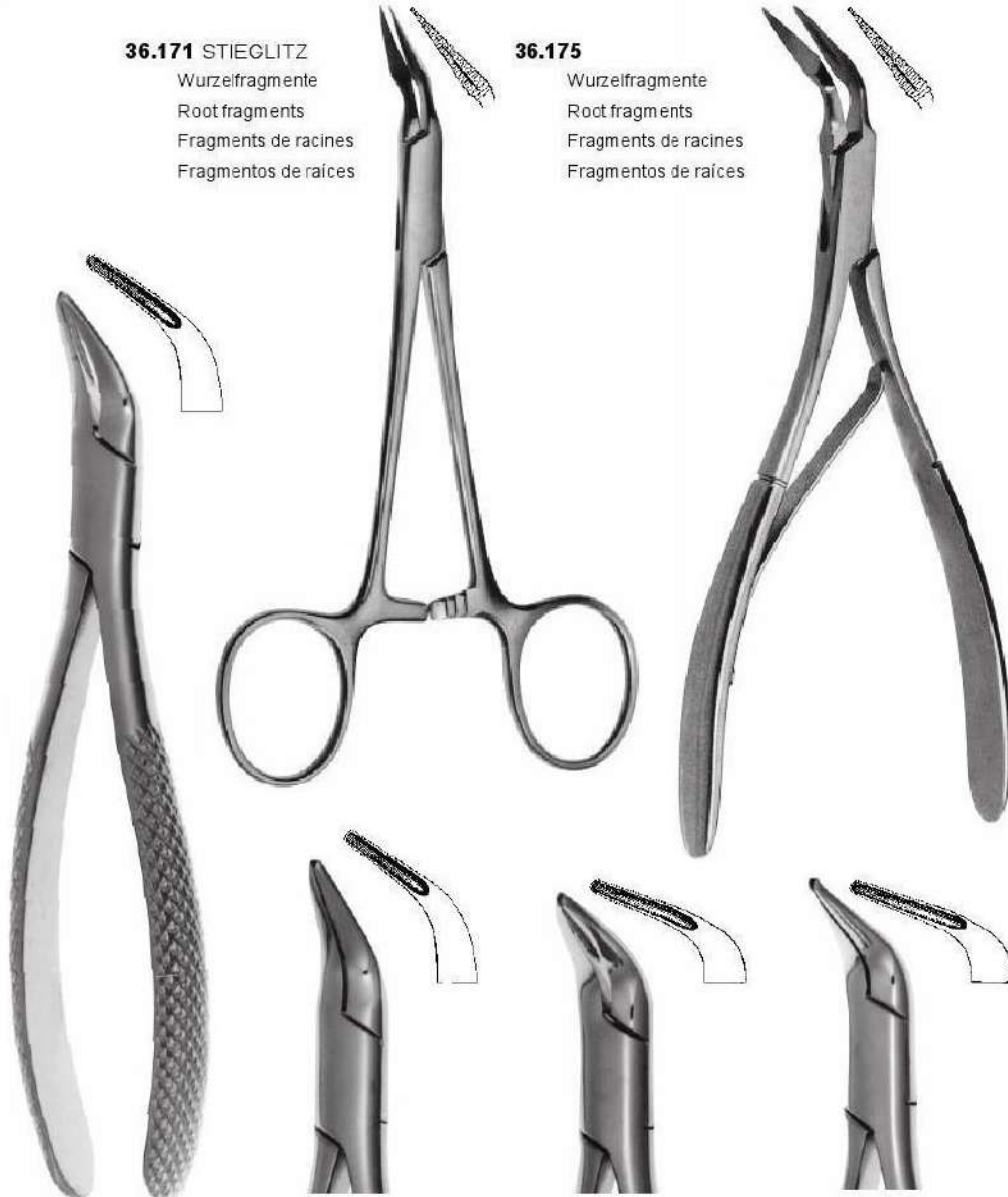

36.166 WITZEL

36.166-300 WITZEL
 obere Wurzeln
 upper roots
 racines supérieures
 raíces superiores

36.169

obere Wurzeln
 upper roots
 racines supérieures
 raíces superiores

36.164 WITZEL

36.164-300 WITZEL
 untere Wurzeln
 lower roots
 racines inférieures
 raíces inferiores

36.168

untere Wurzeln
 lower roots
 racines inférieures
 raíces inferiores

Kinder
 Children
 Enfants
 Niños

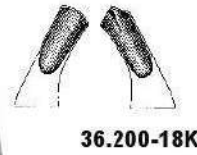
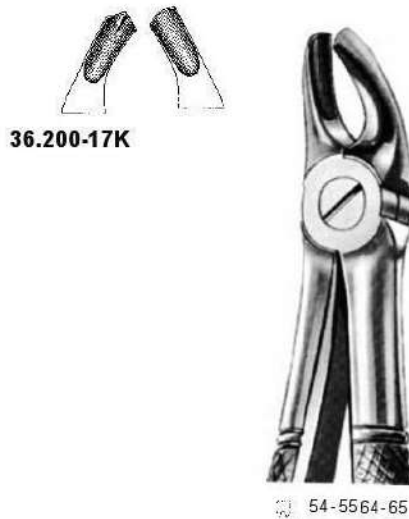

36

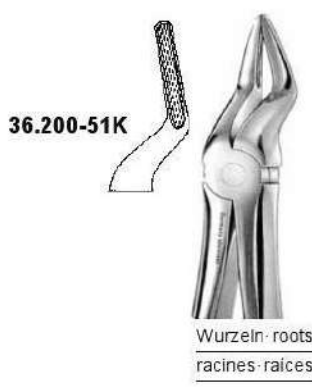

Kinder
 Children
 Enfants
 Niños



Kinder
 Children
 Enfants
 Niños

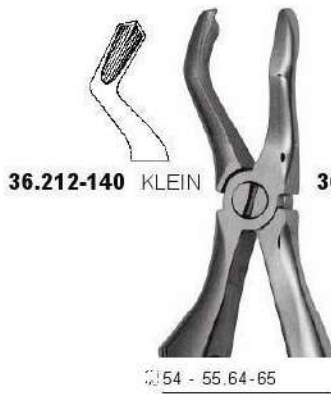

36



Amerikanische Form
 American pattern
 Modèle américain
 Modelo americano

36

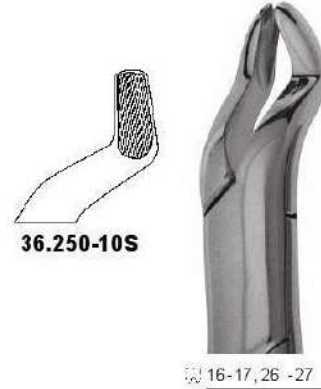

Amerikanische Form
 American pattern
 Modèle américain
 Modelo americano



36

Amerikanische Form
 American pattern
 Modèle américain
 Modelo americano

36



Amerikanische Form
 American pattern
 Modèle américain
 Modelo americano



Hohlmeißelzangen
 Rongeur forceps
 Pincès gorges
 Pinzas gubias

36



36.431-20 MINI-FRIEDMANN
 15,5 cm



36.431-21 MINI-FRIEDMANN
 15 cm, S - Form



36.431-10 MINI-FRIEDMANN
 14,5 cm



36.431 FRIEDMANN
 14 cm

Hohlmeisselzangen
 Rongeur forceps
 Pincers gouges
 Pinzas gubias



36.436-1 LUER
 17cm

36

Hohlmeisseizangen
Rongeur forceps
Pincas gougues
Pinzas gubias

36



36.441 FIG. 3
14,5 cm

36.451 BLUMENTHAL
45°, 14,5 cm



36.514 FIG. 5
16,5 cm

Hohlmeisselzangen
Rongeur forceps
Pinces gouges
Pinzas gubias



36.500 BÖHLER
16,5 cm



36.503 BEYER
18 cm

36

- ▶ Sehr graziiler Wurzelheber für feinfühliges Arbeiten
- ▶ Very delicate elevator for gentle working
- ▶ Elévateur très gracile pour un travail délicat
- ▶ Elevador muy grácil para un trabajo suave

36

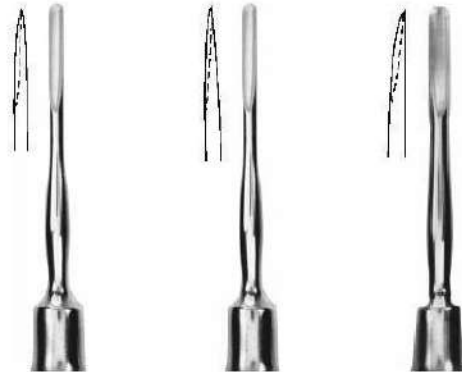

36.610-2 LUXATOR	36.610-3 LUXATOR	36.610-4 LUXATOR
2,5 mm, sehr fein	3,5 mm, sehr fein	4,5 mm, sehr fein
2,5 mm, very delicate	3,5 mm, very delicate	4,5 mm, very delicate
2,5 mm, très gracile	3,5 mm, très gracile	4,5 mm, très gracile
2,5 mm, muy grácil	3,5 mm, muy grácil	4,5 mm, muy grácil

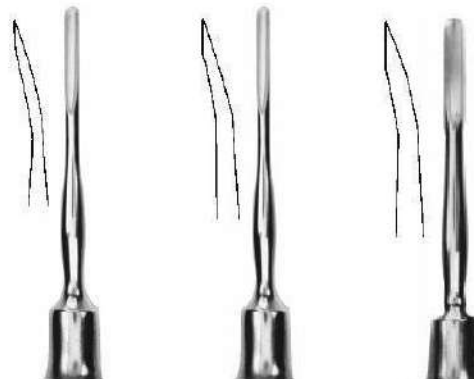

36.610-12 LUXATOR	36.610-13 LUXATOR	36.610-14 LUXATOR
2,5 mm, sehr fein	3,5 mm, sehr fein	4,5 mm, sehr fein
2,5 mm, very delicate	3,5 mm, very delicate	4,5 mm, very delicate
2,5 mm, très gracile	3,5 mm, très gracile	4,5 mm, très gracile
2,5 mm, muy grácil	3,5 mm, muy grácil	4,5 mm, muy grácil

gerade
 straight
 droit
 recto

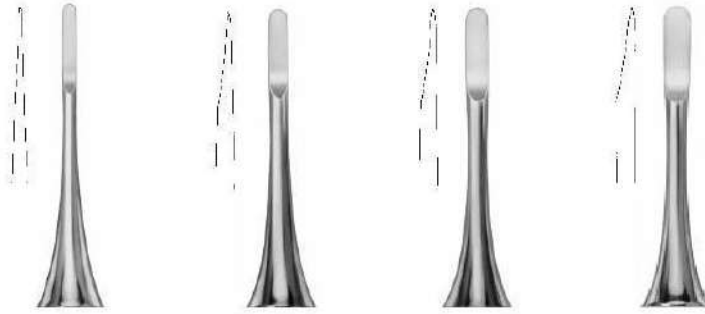

36.614-2 LUXATOR 2 mm **36.614-3 LUXATOR** 3 mm **36.614-4 LUXATOR** 4 mm **36.614-5 LUXATOR** 5 mm

gebogen
 curved
 courbé
 curva

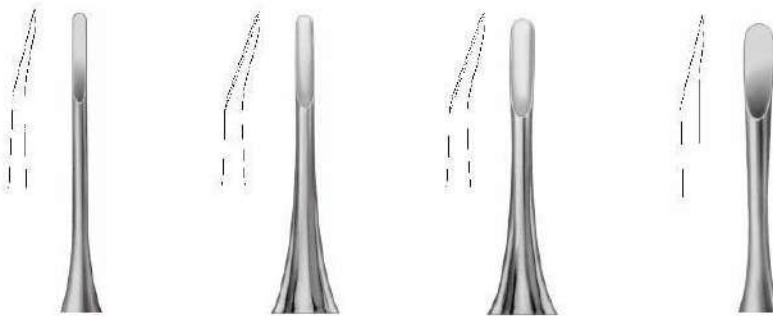

36.614-12 LUXATOR 2 mm **36.614-13 LUXATOR** 3 mm **36.614-14 LUXATOR** 4 mm **36.614-15 LUXATOR** 5 mm



36

36





36.636-1



36.636-2



36.636-3



36.636-4

36



36.636-5



36.636-6

36



36.646-1 COUPLAND
3 mm



36.646-2 COUPLAND
3,8 mm



36.646-3 COUPLAND
4,6 mm



36.640-1 HYLIN



36.640-2 HYLIN



36.642 FIG. 3



FLOHR

36



APICAL

36



36.1490-1 CHOMPRET
 Syndesmotome
 Syndesmotomes
 Sindesmotomes
 Sindesmotomos



36.1490-2



36.1490-3



36.1491-2 massiv
 Syndesmotome
 Syndesmotomes
 Sindesmotomes
 Sindesmotomos



36.1491-12 SYNDESMOTOME
 fein gezahnt, massiv
 fine serrated, massive
 denté fin, massif
 dentado fino, masivo



36

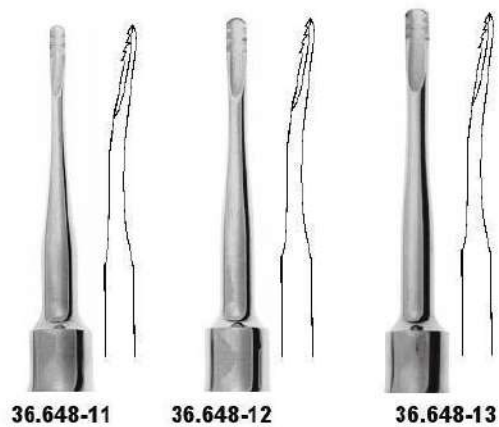

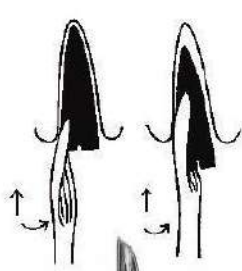

36.710-1 KOPP



36.710-2 KOPP



36.710-3 KOPP



36.710-4 KOPP

36



KOPP



36.710-11 KOPP



36.710-12 KOPP



36.710-13 KOPP



36.710-14 KOPP



KOPP



36.723 COLEMAN



36.726-1 LONDON HOS PITAL 36.726-2



36.804-1 WARWICK-JAMES



36.804-2 WARWICK-JAMES 36.804-3



36.838-1 SELDIN **36.838-2 SELDIN**
 6+7, Fig. 1L 6+7, Fig. 1R

36



36.830-1 CRYER



36.830-2 CRYER



36.835-1 CRYER



36.835-2 CRYER



36.836-27 CRYER



36.836-28 CRYER



36



Kralenheber
 Claw elevators
 Elévateurs à griffes
 Elevadores de garra



36.920-2 POTT



36



36.760-2

36.760-1

für Molaren-Wurzeln
 for molar roots
 pour racines de molaires
 para raíces de molares



36.920-1 POTT

nur für Wurzelfragmente
for root fragments only
seulement pour des fragments
solamente para fragmentos

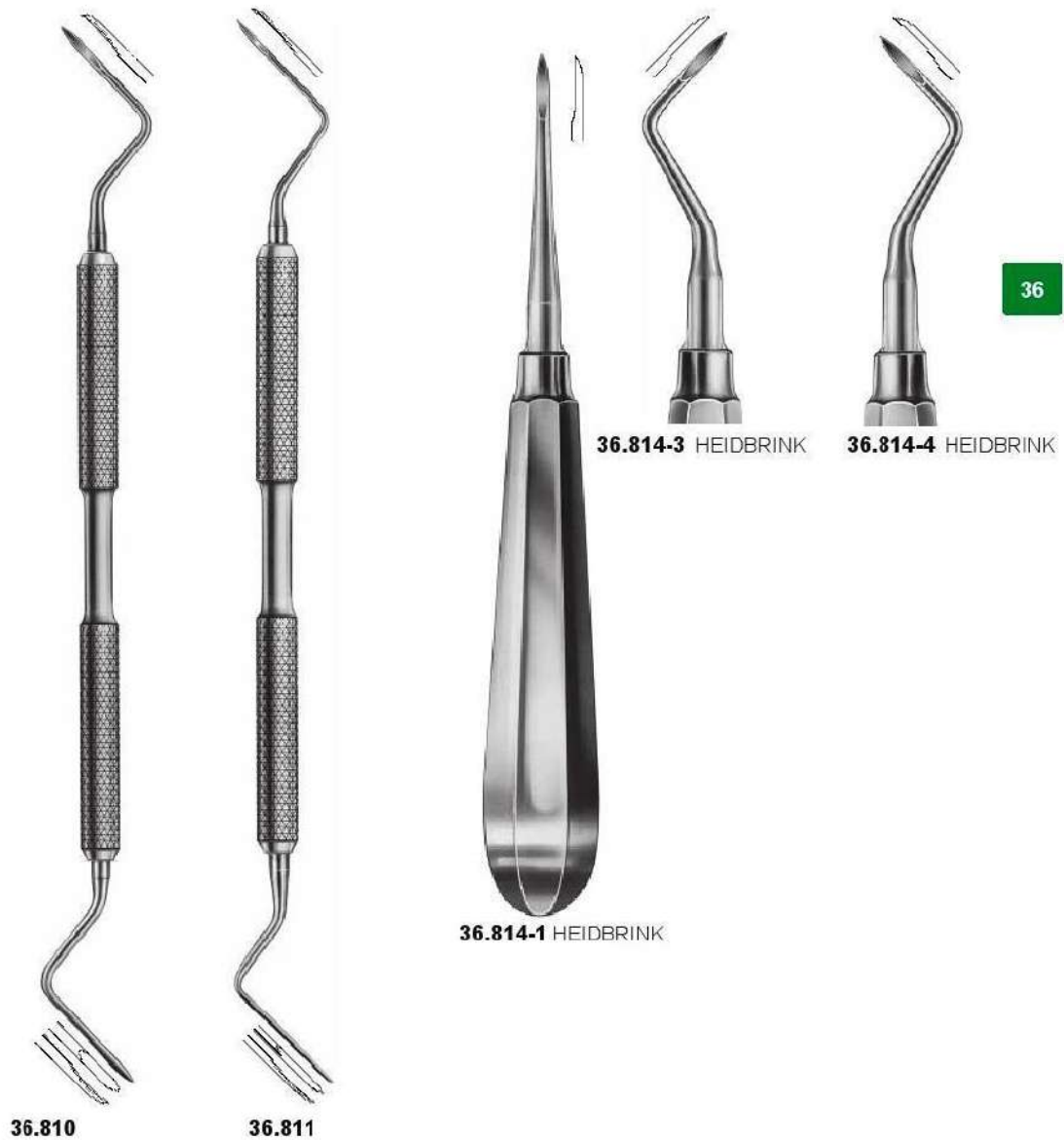

Drehmeissel
 Chisels
 Ciseaux-burins
 Cinceles

gerade / straight / droit / recto / retto, 13 cm

- 36.925-2** 2 mm
- 36.925-3** 3 mm
- 36.925-4** 4 mm



bajonett / bayonet / baionnette / bayoneta / baionetta, 13 cm

- 36.926-2** 2 mm
- 36.926-3** 3 mm
- 36.926-4** 4 mm



36

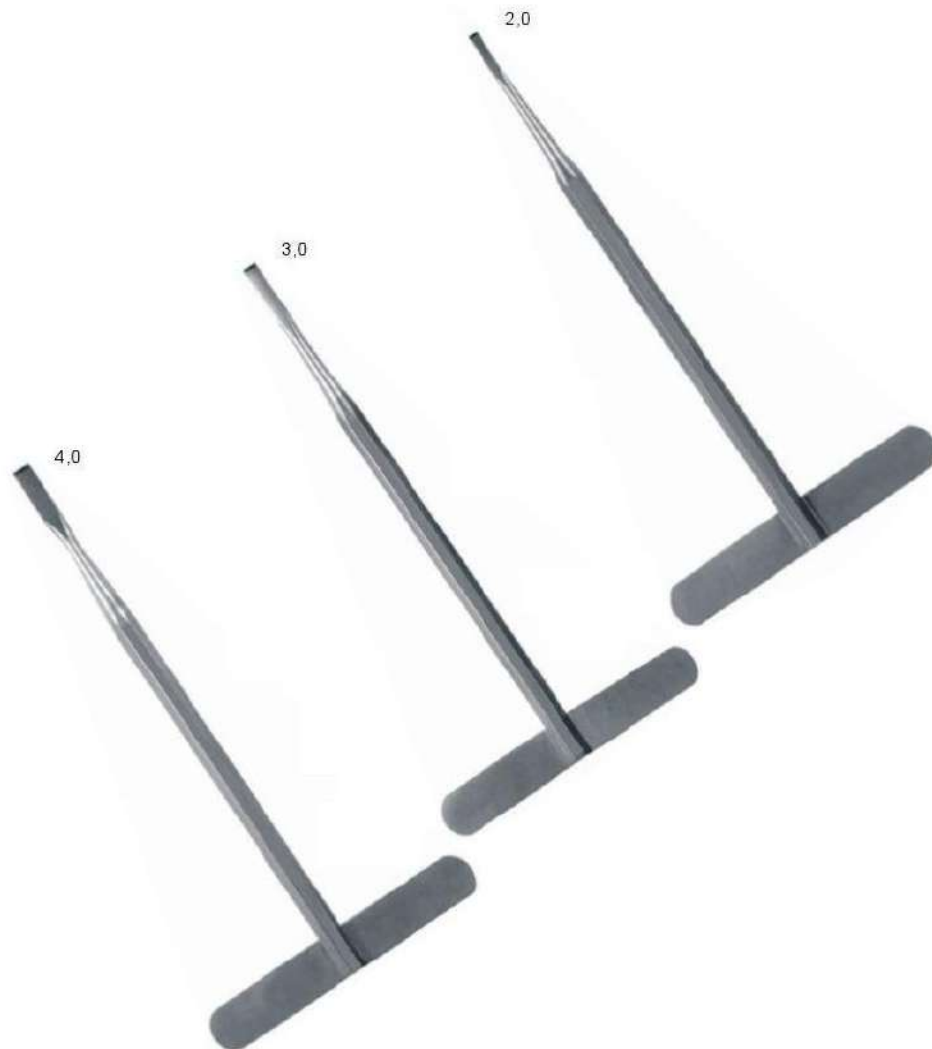



37

SURGERY
CHIRURGIE
CHIRURGIE
CIRUGÍA

37.1070-61 - 69

Mini-Klingen steril / P. zu 10 Stück
 Mini blades sterile / P. of 10 pieces
 Mini lames stérile / P. de 10 pièces
 Mini hojas estériles / P. de 10 piezas

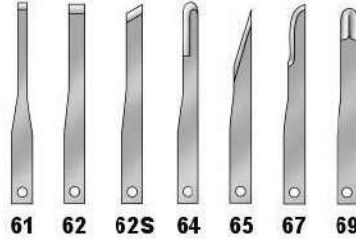

37.1071-10 10 cm
37.1071-13 13 cm
37.1071-15 15 cm

Halter für Mini-Klingen
 Holder for Mini blades
 Manche pour Mini lames
 Mango para Mini hojas

37



37.1035

Rasierklinghalter
 Razor blade holder
 Porte lames à rasoir
 Mango para hojas de afeitarse

Skalpellklingen
 Scalpel blades
 Lames de bistouris
 Hojas de bisturios

	unsteril non-sterile non-stérile no estériles	steril sterile stérile estériles
Fig. 10	37.1053-10	37.1063-10
Fig. 11	37.1053-11	37.1063-11
Fig. 12	37.1053-12	37.1063-12
Fig. 12d	37.1053-12D	37.1063-12D
Fig. 13	37.1053-13	37.1063-13
Fig. 15	37.1053-15	37.1063-15
Fig. 15c	37.1053-15C	37.1063-15C



Skalpellgriffe
 Scalpel handles
 Manches pour bistouris
 Mangos de bisturios



37.1043 FIG. 3



37.1043-1



37.1033-1

37.1033-3

37

37.1050

Klingentferner
 Blade remover
 Enlève-lames
 Removedor de hojas



37



37.3405 BLAKE



37.1047 FIG. 7



- 37.1033-10** 1,0 mm
- 37.1033-15** 1,5 mm
- 37.1033-20** 2,0 mm
- 37.1033-25** 2,5 mm
- 37.1033-30** 3,0 mm

Parallelklingen-Skalpellgriff
 Parallel blade scalpel handle
 Lames parallèles-manches pour bistouris
 Hojas paralelas-mangos de bisturís

- ▶ Extrem leichtes Schneiden
- ▶ Kein Abrutschen des Zahnfleisches
- ▶ Verringertes Trauma

- ▶ Extremely easy cutting
- ▶ No tissue slippage
- ▶ Reduced trauma

- ▶ Une coupe très facile
- ▶ Pas de glissement du tissu
- ▶ Réduction du traumatisme

- ▶ Corta muy facil
- ▶ Tejido no se desliza
- ▶ Trauma reducido

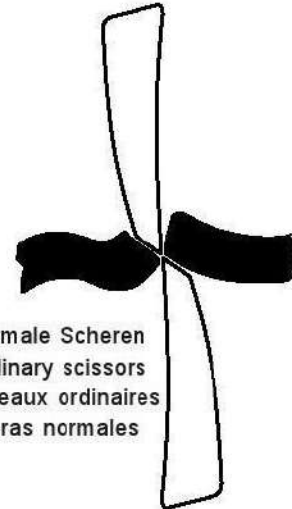

Normale Scheren
 Ordinary scissors
 Ciseaux ordinaires
 Tijeras normales

37

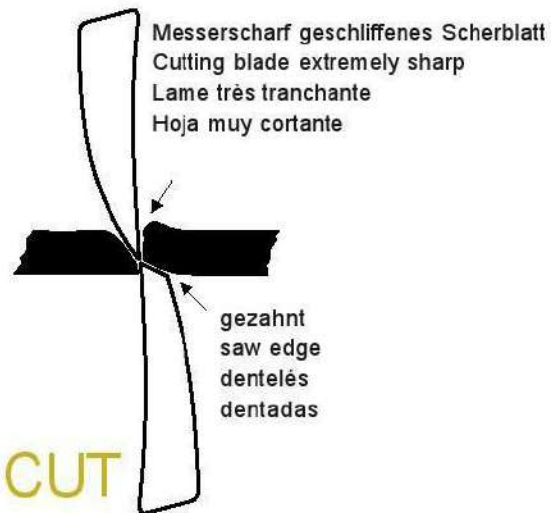

Messerscharf geschliffenes Scherblatt
 Cutting blade extremely sharp
 Lame très tranchante
 Hoja muy cortante

gezahnt
 saw edge
 dentelés
 dentadas

SUPER CUT



2/3
37.1110-400 SUPER CUT
 11,5 cm



2/3
37.1111-400 SUPER CUT
 11,5 cm



2/3
37.1143-400 KELLY
 16 cm



2/3
37.1133-400 LA GRANGE
 11,5 cm



2/3
37.1117-400 GOLDMANN-FOX
 13 cm

37



2/3

37.1108

11,5 cm, schlank
 11,5 cm, slim
 11,5 cm, graciles
 11,5 cm, delgadas

37.1109

11,5 cm, schlank
 11,5 cm, slim
 11,5 cm, graciles
 11,5 cm, delgadas

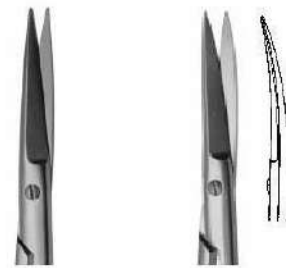

2/3

37.1110 STANDARD
 11,5 cm

37.1110-400 SUPER CUT

37.1180 TC GOLD
 Hartmetalleinsätze
 Tungsten carbide inserts
 Mors en tungstène
 Puntas de tungsteno



37.1111 STANDARD
 11,5 cm

37.1111-400 SUPER CUT

37.1181 TC GOLD
 Hartmetalleinsätze
 Tungsten carbide inserts
 Mors en tungstène
 Puntas de tungsteno

37



2/3

37.1113

11,5 cm

37.1114

11,5 cm

37.1115

11,5 cm

37.1119 STEVENS

11,5 cm



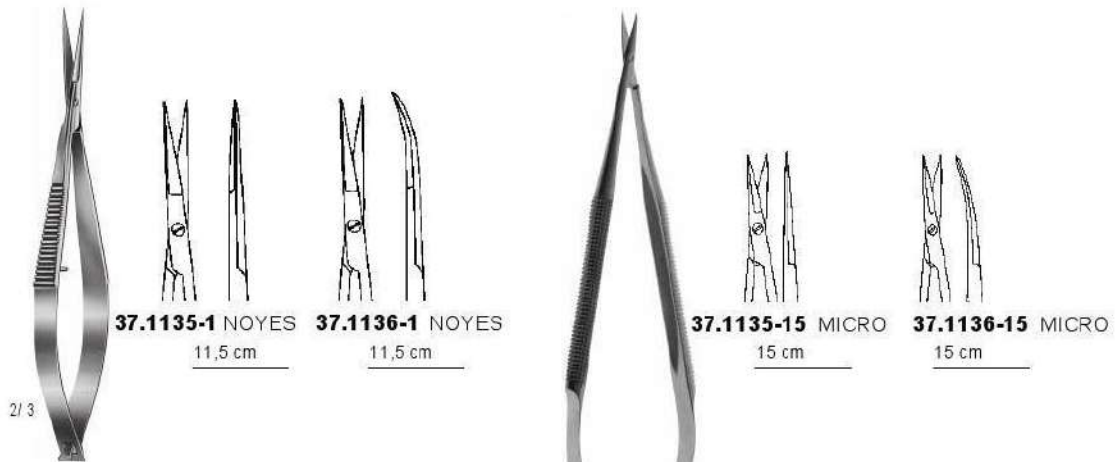

37



37.1133 LA GRANGE
 11,5 cm , gezahnt
 11,5 cm , saw edge
 11,5 cm , dentelés
 11,5 cm , dentadas

37.1133-400 SUPER CUT



37.1120
 12 cm

37.1121
 12 cm

37.1129 WAGNER
 12 cm , gezahnt

37.1129 WAGNER
 12 cm , saw edge
 12 cm , dentelés
 12 cm , dentadas



37.1131 QUINBY
 12,5 cm



37.1116 GOLDMANN-FOX
 13 cm, gezahnt, gerade
 13 cm, saw edge, straight
 13 cm, dentelés, droits
 13 cm, dentadas, rectas

37



37.1117 GOLDMANN-FOX
 13 cm, gezahnt, gebogen
 13 cm, saw edge, curved
 13 cm, dentelés, courbés
 13 cm, dentadas, curvas



37.1117-400 SUPER CUT
37.1185 GOLDMANN-FOX TC GOLD
 Hartmetalleinsätze
 Tungsten carbide inserts
 Mors en tungstène
 Puntas de tungsteno



37.1117-1 GOLDMANN-FOX
 13 cm, gezahnt, S-gebogen
 13 cm, saw edge, S-curved
 13 cm, dentelés, S-courbés
 13 cm, dentadas, curvatura S

37



Ligaturscheren
 Ligature scissors
 Ciseaux à ligatures
 Tijeras para ligaduras



37.1168-11 SPENCER

11 cm



37.1168-200 SPENCER

11 cm



37.1168 SPENCER

9 cm



37.1169 LITTAUER

12,5 cm



37.1169-200 NORTHBENT

12,5 cm

37

37



37.1139-18 METZENBAUM
 18 cm

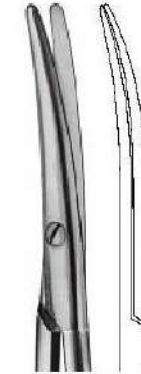

37.1139-14 METZENBAUM
 14 cm



37.1161-13
 13 cm

37.1161-14
 14,5 cm



37.1162-13
 13 cm

37.1162-14
 14,5 cm



37.1163-13
 13 cm

37.1163-14
 14,5 cm



37.1207 ADSON

12 cm



37.1220-12 ADSON TC GOLD

- 12 cm, Hartmetalleinsätze
- 12 cm, tungsten carbide inserts
- 12 cm, mors en tungstène
- 12 cm, puntas de tungsteno



37.1220-15 ADSON TC GOLD

- 15 cm, Hartmetalleinsätze
- 15 cm, tungsten carbide inserts
- 15 cm, mors en tungstène
- 15 cm, puntas de tungsteno



37.1207-115 MICRO-ADSON

- 15 cm, sehr fein
- 15 cm, very fine
- 15 cm, très fine
- 15 cm, muy finas

37



37.1197-13 SEMKEN

13 cm

37.1197-15 SEMKEN

15 cm



37.1201-13

13 cm

37.1201-14

14 cm



37.1205-13

13 cm

37.1205-14

14 cm

37.1205-162

- 16 cm, kreuzgeriefte Arbeitsenden
- 16 cm, cross-serrated tips
- 16 cm, pointes quadrillés
- 16 cm, puntas con forma de diamante







37.1208 ADSON
 12 cm



37.1208-115 MICRO-ADSON
 15 cm, sehr fein
 15 cm, very fine
 15 cm, très fine
 15 cm, muy finas



37.1208-215 MICRO-ADSON
 15 cm, sehr fein
 15 cm, very fine
 15 cm, très fine
 15 cm, muy finas

37



37.1198-13 SEMKEN
 13 cm

37.1198-15 SEMKEN
 15 cm

37.1198-131 SEMKEN
 13 cm

37.1198-151 SEMKEN
 15 cm



37.1202-13
 13 cm

37.1202-14
 14 cm



37.1206-13
 13 cm

37.1206-14
 14 cm



37.1218 GILLIES
 16 cm

37



37.1214-1 MICRO CUSHING

18 cm, sehr fein
 18 cm, very fine
 18 cm, très fine
 18 cm, muy finas

37.1212 TAYLOR 18 cm **37.1214 CUSHIN** 18 cm



37.1222-1 FOX Gewebebinzette, 15,5 cm Gum seizing forceps, 15,5 cm Pince à gencive, 15,5 cm Pinzas para gingiva, 15,5 cm	37.1222 FOX mit Schloß with lock avec arrêt con cerradura	37.3426-1 CRANE-KAPLAN Taschenmarkierungspinzetten Pocket markers Pincas à marquer la poche Pinzas para marcar el sulco periodontal	37.3426-2 mit Schloß, 20 cm with lock, 20 cm avec arrêt, 20 cm con cerradura, 20 cm	37.1221-20 mit Schloß, 20 cm with lock, 20 cm avec arrêt, 20 cm con cerradura, 20 cm
---	--	--	--	---

Arterienklemmen
 Haemostatic forceps
 Pinces hémostatiques
 Pinzas hemostáticas

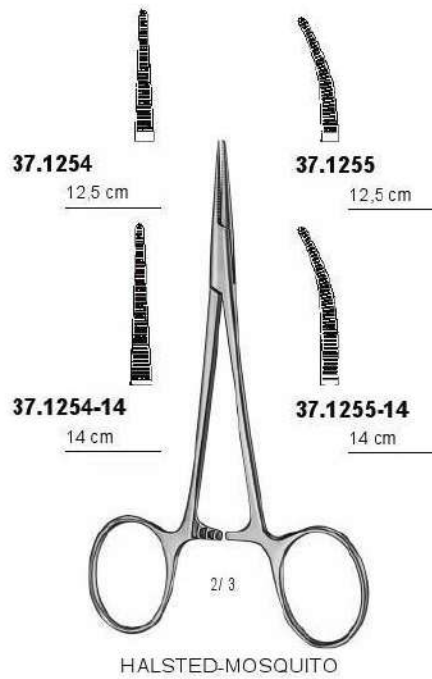

37



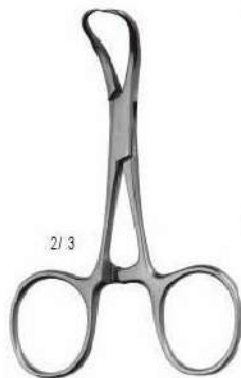

37.1284-9 BACKHAUS

9 cm, Tuchklemme
 9 cm, towel clip
 9 cm, pince à champs
 9 cm, pinza de campo

37.1284-11 BACKHAUS

11 cm, Tuchklemme
 11 cm, towel clip
 11 cm, pince à champs
 11 cm, pinza de campo



37.1280 JONES

8,5 cm, Tuchklemme
 8,5 cm, towel clip
 8,5 cm, pince à champs
 8,5 cm, pinza de campo

37



37.1264 ALLIS

15,5 cm, Zahnfleischfaßzange
 15,5 cm, gum seizing forceps
 15,5 cm, pince à gencive
 15,5 cm, pinza para filar la encía



37.1290-20 GROSS

20 cm, Kornzange
 20 cm, dressing forceps
 20 cm, pince à pansement
 20 cm, pinza para curaciones



37.1291-20 GROSS

20 cm, Kornzange
 20 cm, dressing forceps
 20 cm, pince à pansement
 20 cm, pinza para curaciones



37

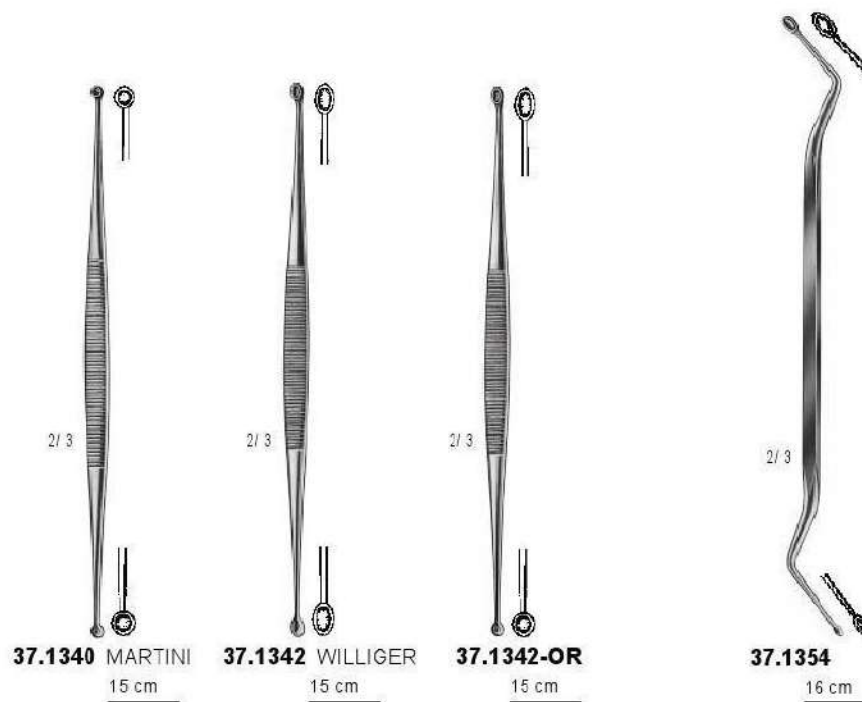

37

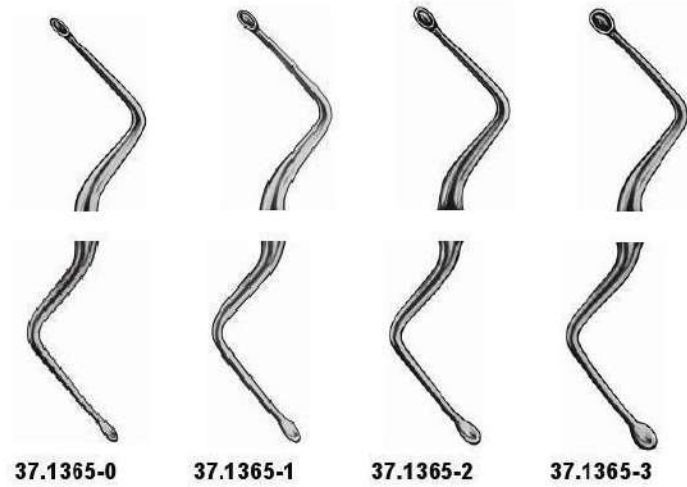
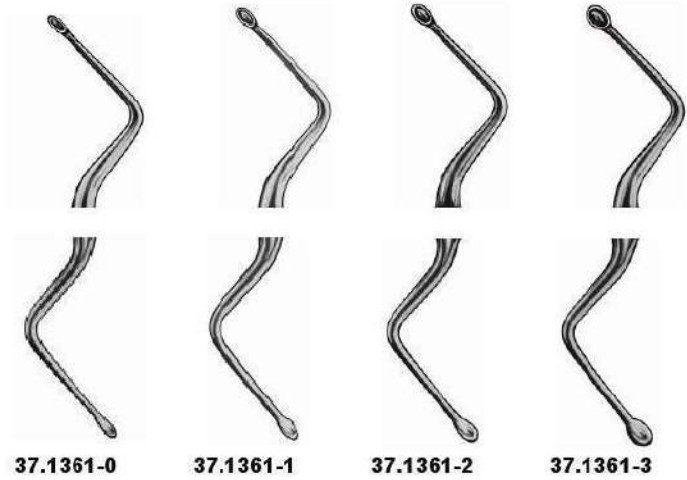
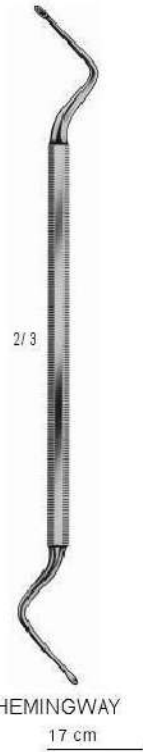

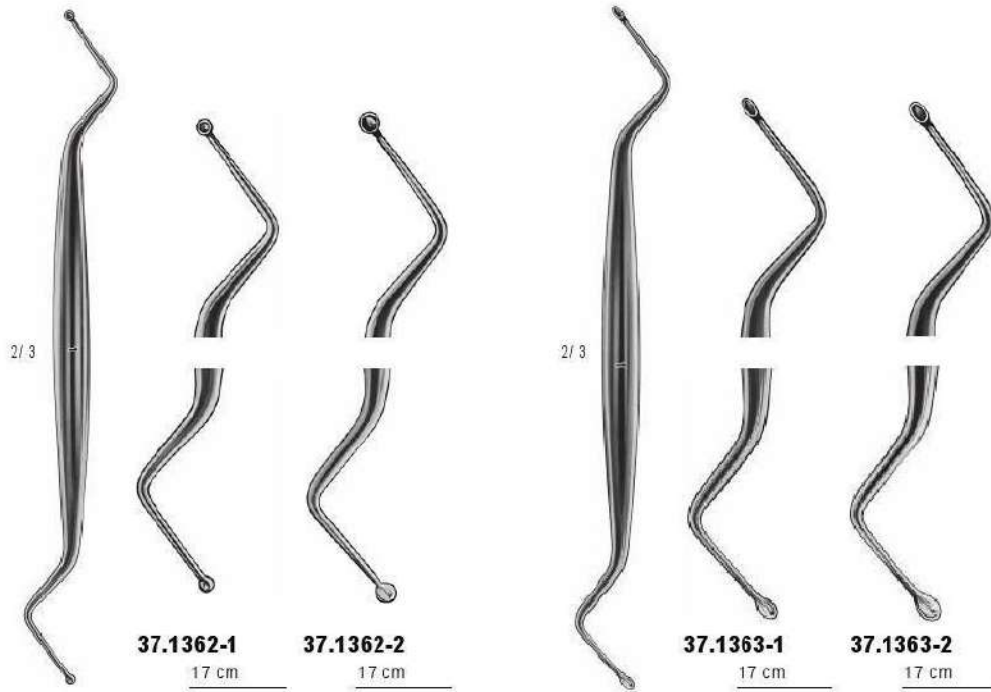

37

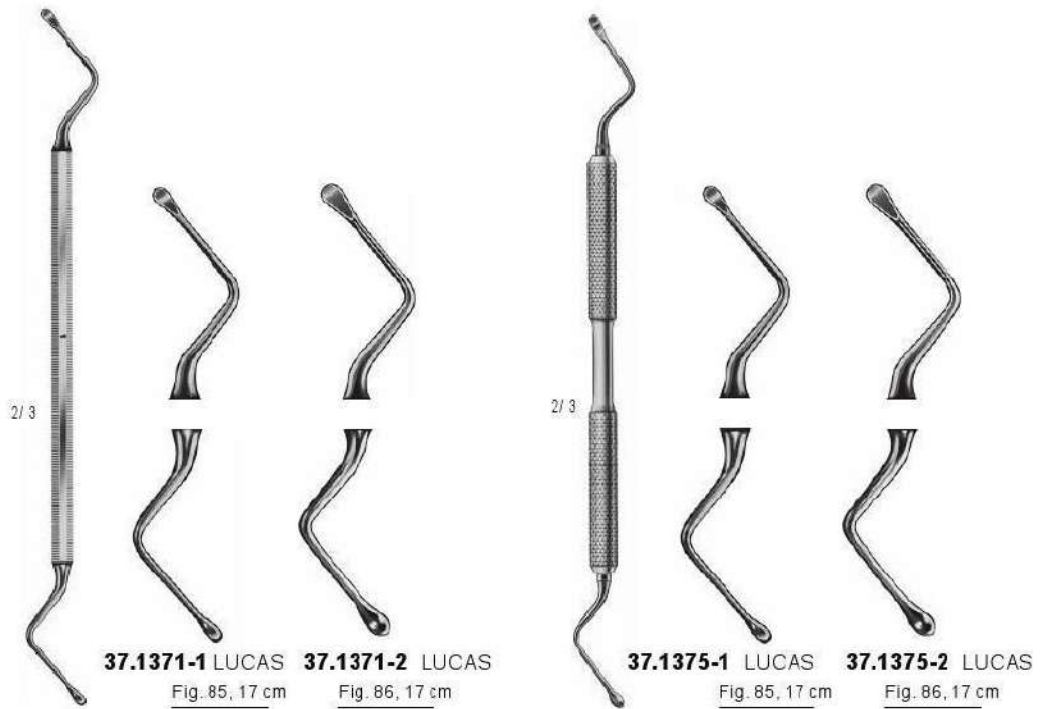

Raspatorien
 Raspatories
 Rugines-raspatoires
 Periostótomos



Raspatorien
 Raspatories
 Rugines-raspatoires
 Periostótomos

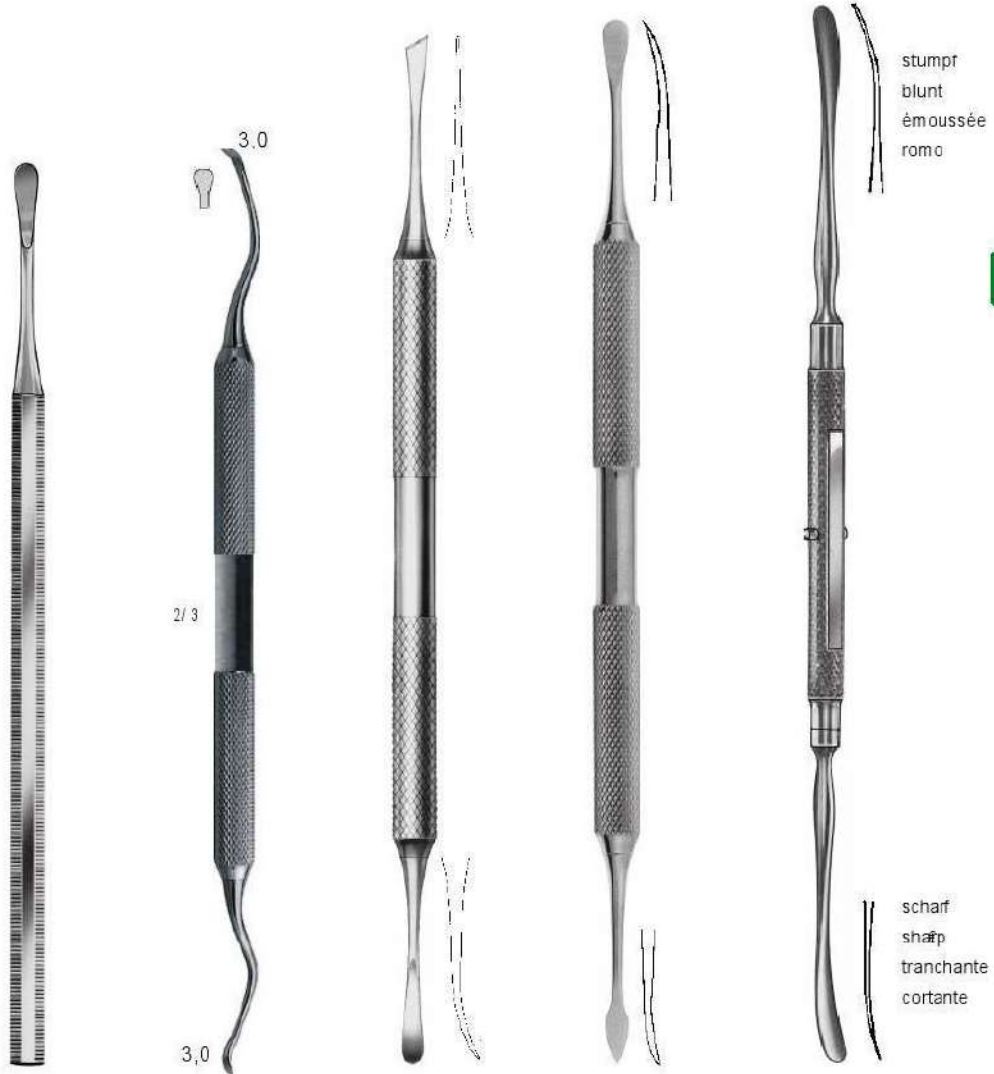

37.1376 PARTSCH
 15 cm

37.1378

37.1401-1

37.1409

37.1408 FREER

Raspatorien
 Raspatories
 Rugines-raspatoires
 Periostótomos



37.1407-24 MOLT
 Fig. 2/4

37.1400 MOLT
 Fig. 9

37.1406 FOX

37.1407 MOLT

37.1393 SELDIN
 Fig. 23, 19 cm

Raspatorien
 Raspatories
 Rugines-raspatoires
 Periostótomos



37.1405 PRICHARD

37.1401 WEST

37.1412-1 FREER
 scharf
 sharp
 tranchante
 cortante

37.1412-21 FREER
 stumpf
 blunt
 émoussée
 romo

37.1412-2 FREER
 scharf
 sharp
 tranchante
 cortante

37.1412-22 FREER
 stumpf
 blunt
 émoussée
 romo

37

Knochenfeilen Chirurgische Küretten
 Bone files Surgical curettes
 Râpes à os Curettes à chirurgie
 Limas de hueso Curetas para cirugía

37



MILLER-COLBURN
 17 cm. Knochenfeilen
 17 cm. bone files
 17 cm. râpes à os
 17 cm. limas de hueso



37.3385-1 KRAMER **37.3385-2** KRAMER **37.3385-3** KRAMER

Meißel
 Chisels
 Burins
 Cinceles



37.1650-2

37.1650-1 OCHSENBEIN
16 cm



37.1650-3 OCHSENBEIN
3



37.1650-4 OCHSENBEIN
4



37.1650-36 RHODES

37

Meißel
Chisels
Burins
Cinceles

37

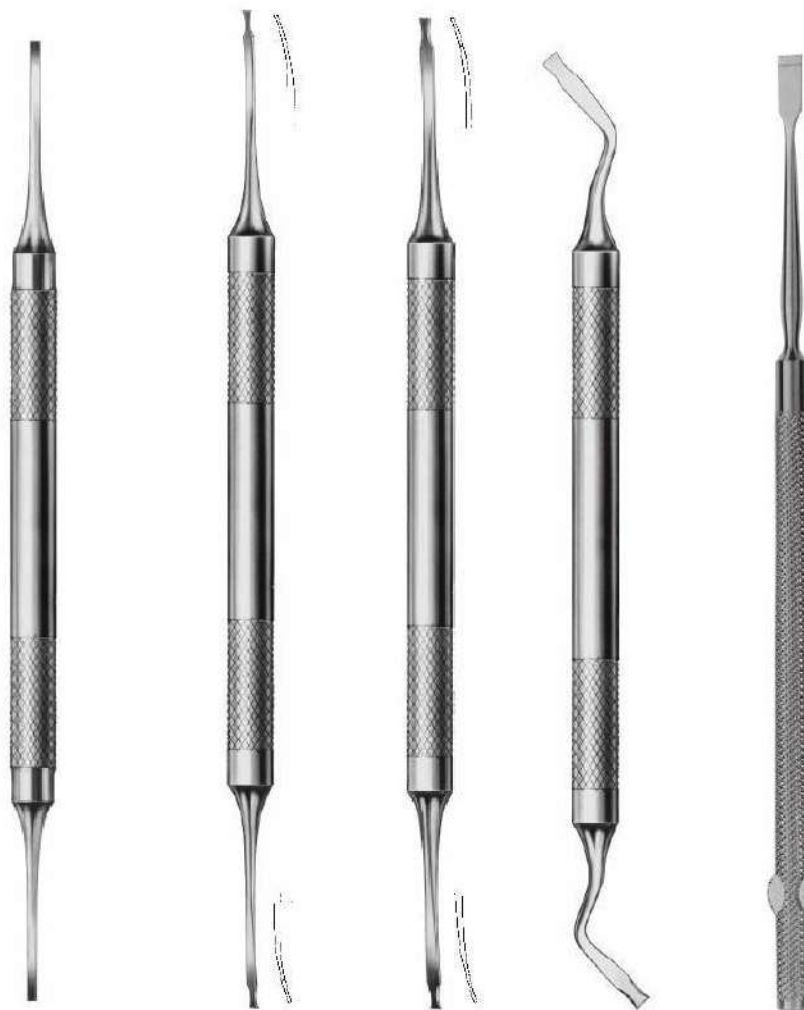

37.1650-12 KRAMER-NEVINS **37.1651-1** FEDI **37.1651-2** FEDI **37.1651-3** FEDI **37.1674-4** FREER
16 cm, 4 mm

Meißel
 Chisels
 Burins
 Cinceles

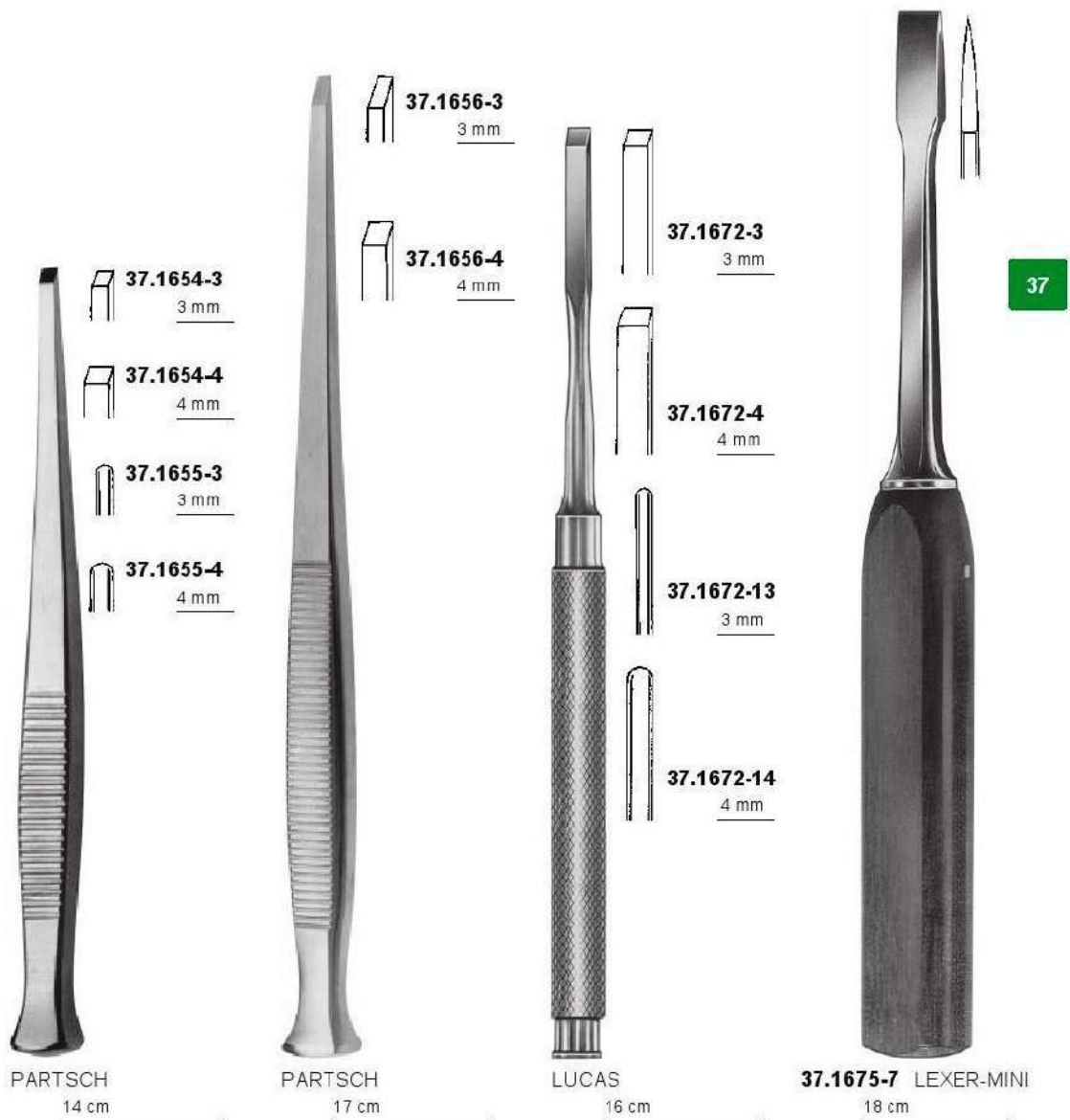

Meißel
 Chisels
 Burins
 Cinceles

37



37.1682-4 EPKER 4 mm
37.1682-6 EPKER 6 mm
37.1682-8 EPKER 8 mm
 18 cm, gerade
 18 cm, straight
 18 cm, droit
 18 cm, recto



37.1682-16 EPKER 6 mm
37.1682-18 EPKER 8 mm
 18 cm, leicht gebogen
 18 cm, slightly curved
 18 cm, courbé légèrement
 18 cm, curvado levemente



37.1682-26 EPKER 6 mm
37.1682-28 EPKER 8 mm
 18 cm, stark gebogen
 18 cm, strong curved
 18 cm, courbé légèrement
 18 cm, curvo



1/2

37.1620 WILLIGER
 21 cm, 230 g, bleigefüllt
 21 cm, 230 g, lead filled
 21 cm, 230 g, garni de plomb
 21 cm, 230 g, relleno de plomo



1/2

37.1621 WILLIGER
 21 cm, 200 g, rostfreier Stahl
 21 cm, 200 g, stainless steel
 21 cm, 200 g, acier inoxydable
 21 cm, 200 g, acero inoxidable



1/2

37.1626
 19 cm, 200 g, bleigefüllt
 19 cm, 200 g, lead filled
 19 cm, 200 g, garni de plomb
 19 cm, 200 g, relleno de plomo

37

Bis 140°C sterilisierbar
 Sterilisation up to 140°C
 Stérilisables jusqu'à 140°C
 Esterilización hasta 140°C



1/2

auswechselbare Kunststoffeinsätze
 interchangeable plastic inserts
 interchangeables en matière plastique
 tapas de plástico intercambiables

37.1632 MEAD
 19 cm, 320 g
 19 cm, 320 g
 19 cm, 320 g
 19 cm, 320 g



1/2

auswechselbare Kunststoffeinsätze
 interchangeable plastic inserts
 interchangeables en matière plastique
 tapas de plástico intercambiables

37.1637
 18,5 cm, 220 g
 18,5 cm, 220 g
 18,5 cm, 220 g
 18,5 cm, 220 g



1/2

37.3740
 19 cm, 180 g, bleigefüllt
 19 cm, 180 g, lead filled
 19 cm, 180 g, rempli de plomb
 19 cm, 180 g, relleno de plomo

Periotome
Periotomes
Périotomes
Periôtomos

Zur atraumatischen Trennung der Scharpey'schen Fasern im PA-Spalt zur schonenden Extraktion.

The specific instrument for atraumatic teeth extraction before implants are placed. No cortical bone damage with this instrument, it cuts the periodontal ligament carefully and easily.

37



37.1706-1



37.1706-2



Sinus Lift Küretten, stumpf
Sinus Lift Curette, blunt
Curette pour sinus lift, émoussée
Cureta para senos lift, romo

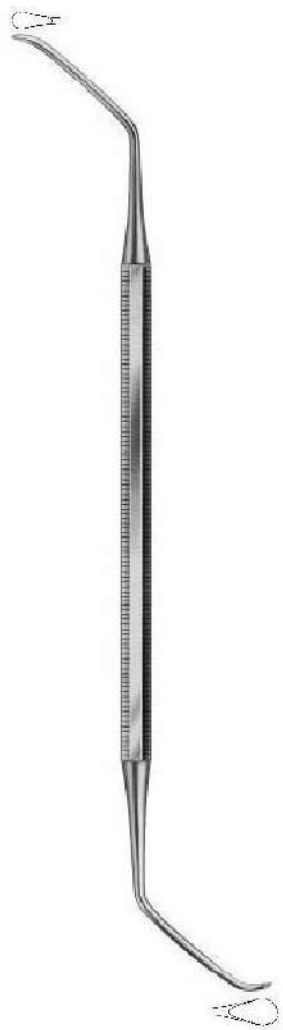

37.1430-1

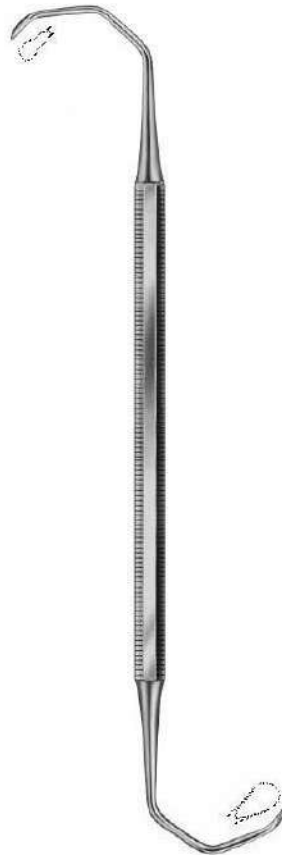

37.1430-2



37.1430-3

37

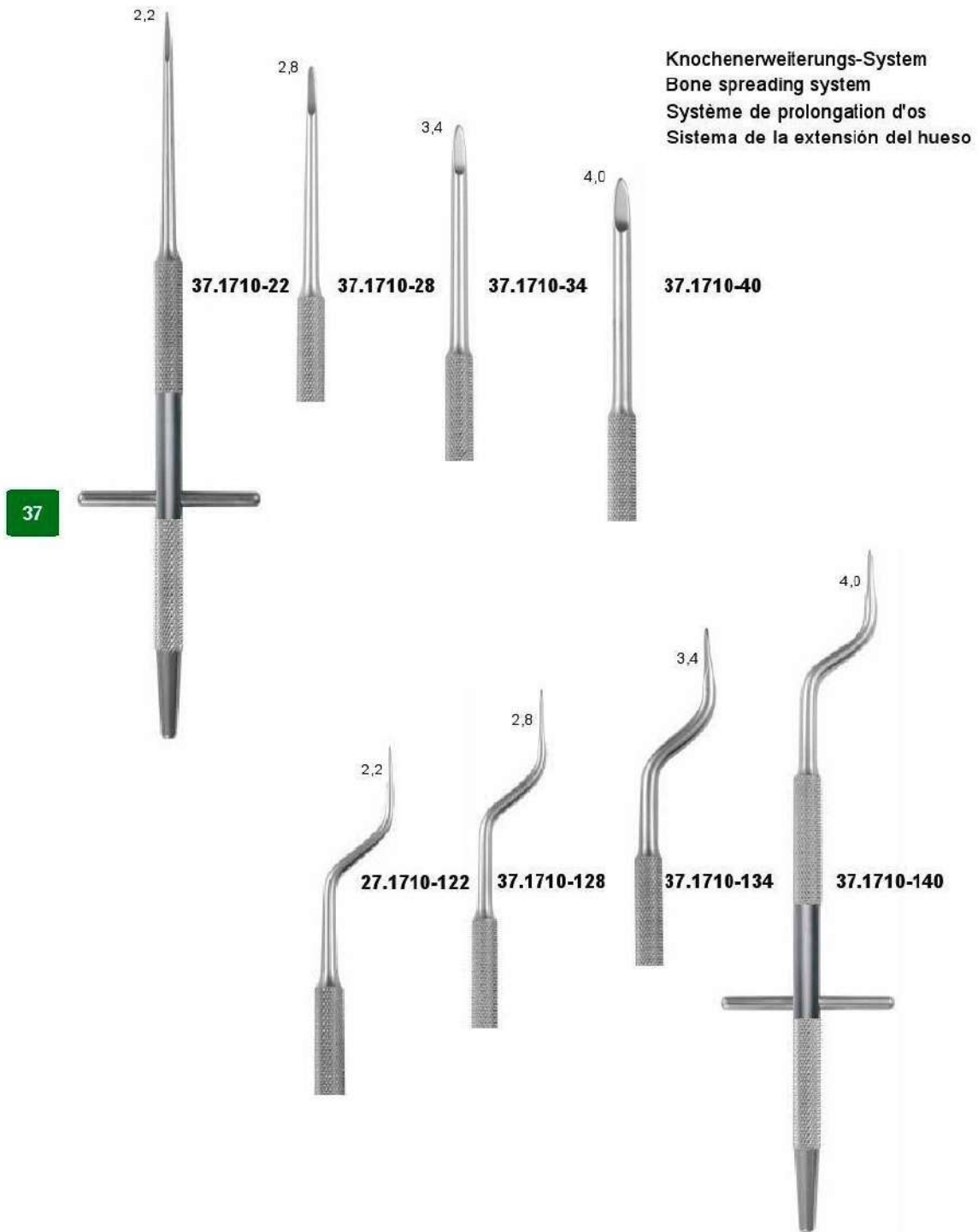

Sinusboden-Elevatoren
 Sinus lift elevators
 Sinus lift élévateurs
 Senos lift elevadores

37.1700-500

Sieb mit 20 Instrumenten
 Tray with 20 instruments
 Plateaux avec 20 instruments
 Bandejas con 20 instrumentos

37.1700-510

Sieb, leer 275 x 175 x 25
 Tray, empty 275 x 175 x 25
 Plateau, vide 275 x 175 x 25
 Bandeja, vacío 275 x 175 x 25



37

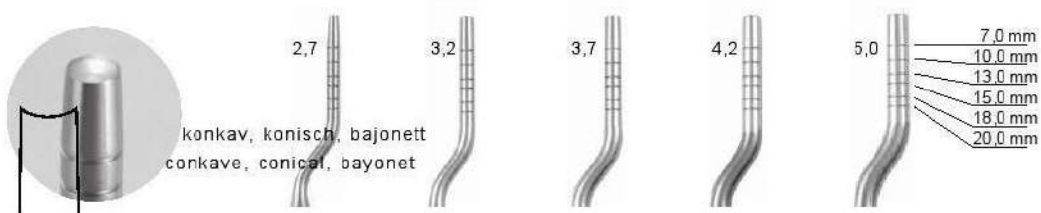

konkav, konisch, bajonett
 konkave, conical, bayonet

37.1701-127 37.1701-132 37.1701-137 37.1701-142 37.1701-150

Sinusboden-Elevatoren
 Sinus lift elevators
 Sinus lift elevateurs
 Senos lift elevadores

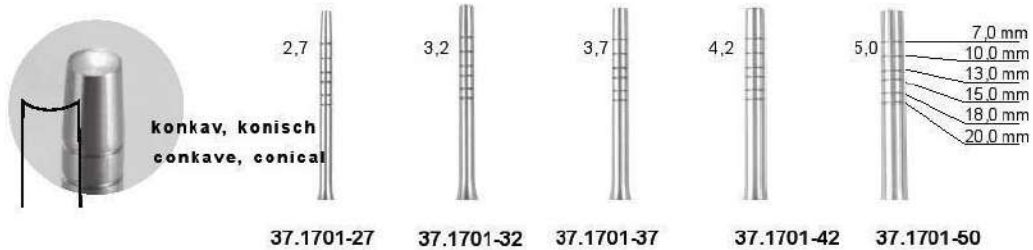
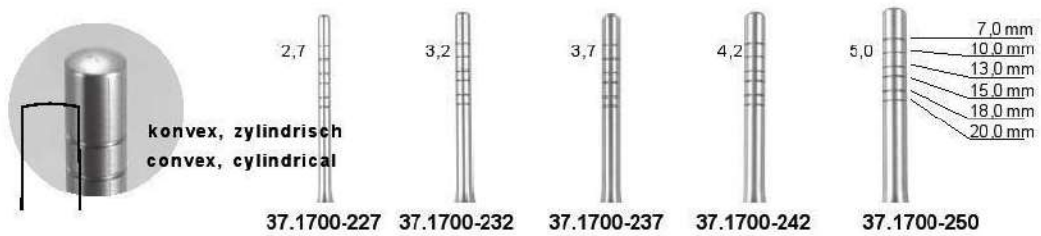
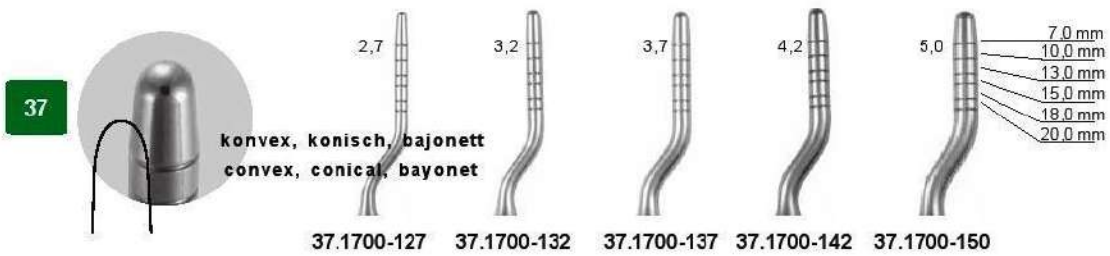
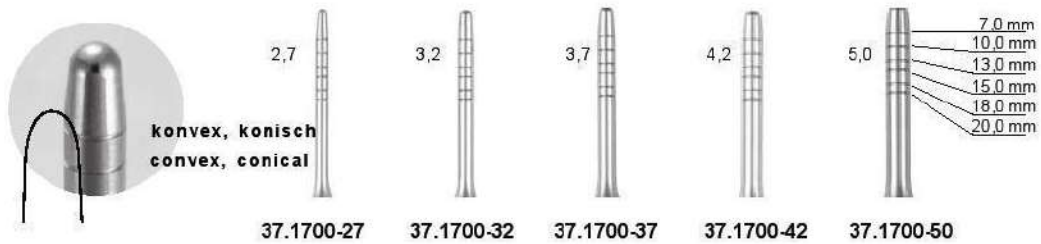

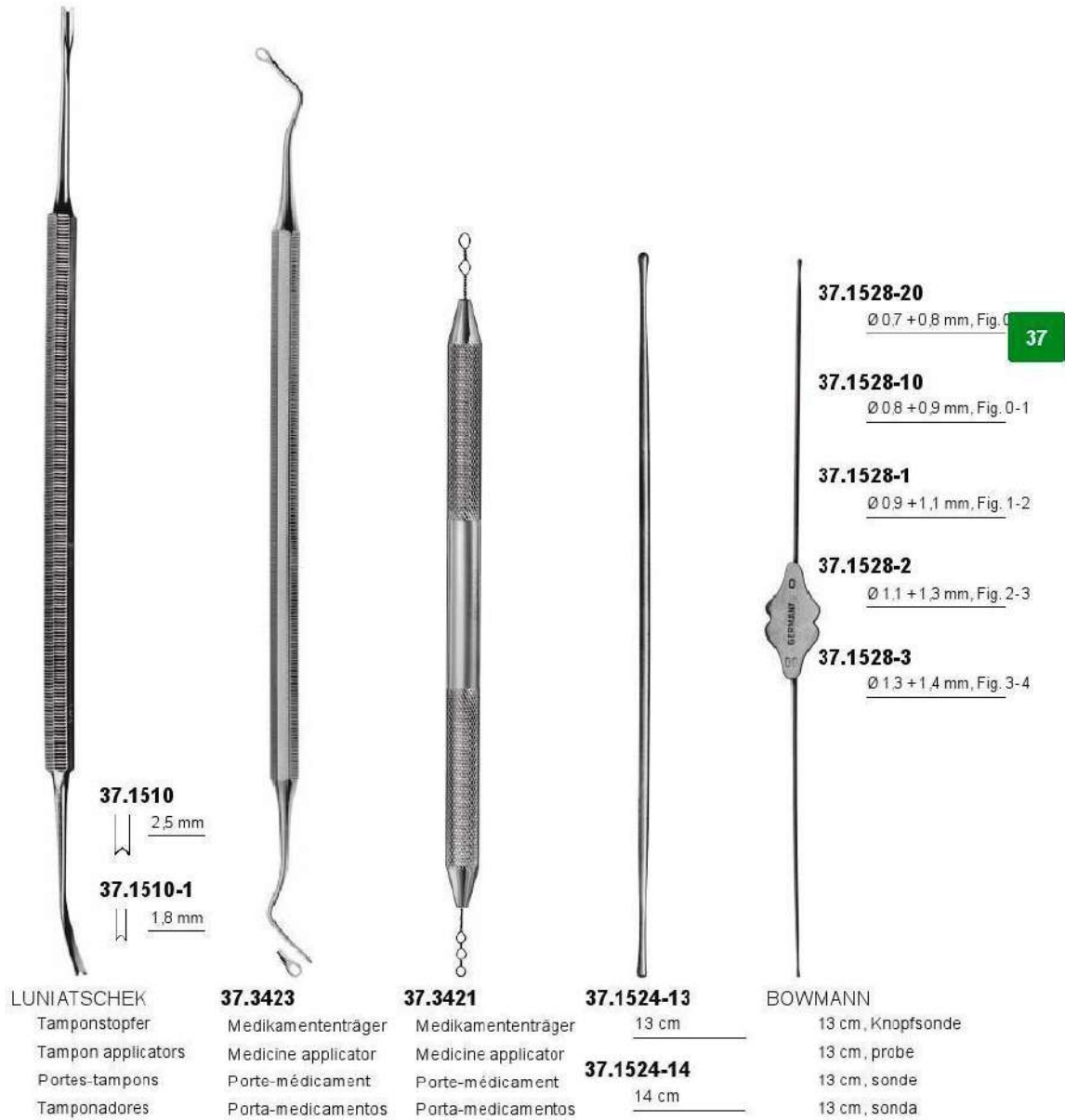

37



37.1863

16 cm, scharf
 16 cm, sharp
 16 cm, tranchant
 16 cm, cortante



37.1868

16 cm, stumpf
 16 cm, blunt
 16 cm, mousse
 16 cm, romo



37.1842 ROLLET

13 cm, scharf
 13 cm, sharp
 13 cm, tranchant
 13 cm, cortante



37.1850 MÜLLER-SENN

16 cm, scharf
 16 cm, sharp
 16 cm, tranchant
 16 cm, cortante



37.1838 KILNER

15 cm



37.1839-1

GILLIES

18 cm



37.1839-2



37.1836-1

10x6 mm

SENN-GREEN

16 cm

37.1836-2

20x6 mm

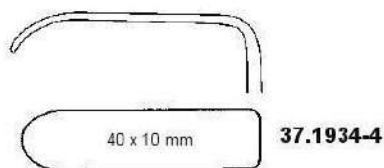
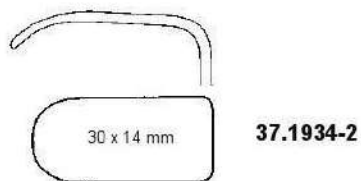
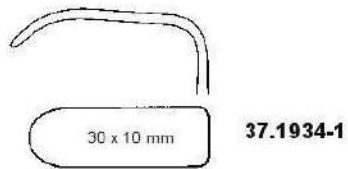
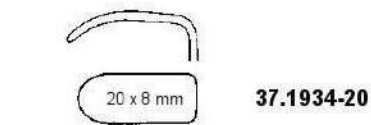

LANGENBECK
22 cm



Kombinierter Wundhaken und Wangenhalter „Schäfer“

Doppelt funktionelles Instrument zum Abhalten des Lappens und der Wange bei chirurgischen Eingriffen wie Implantation und Wurzelspitzenresektion.



Combined wound and cheek retractor „Schäfer“

Dual-purpose instrument for the retraction of flaps and cheek during surgery such as implantation and apicectomy.





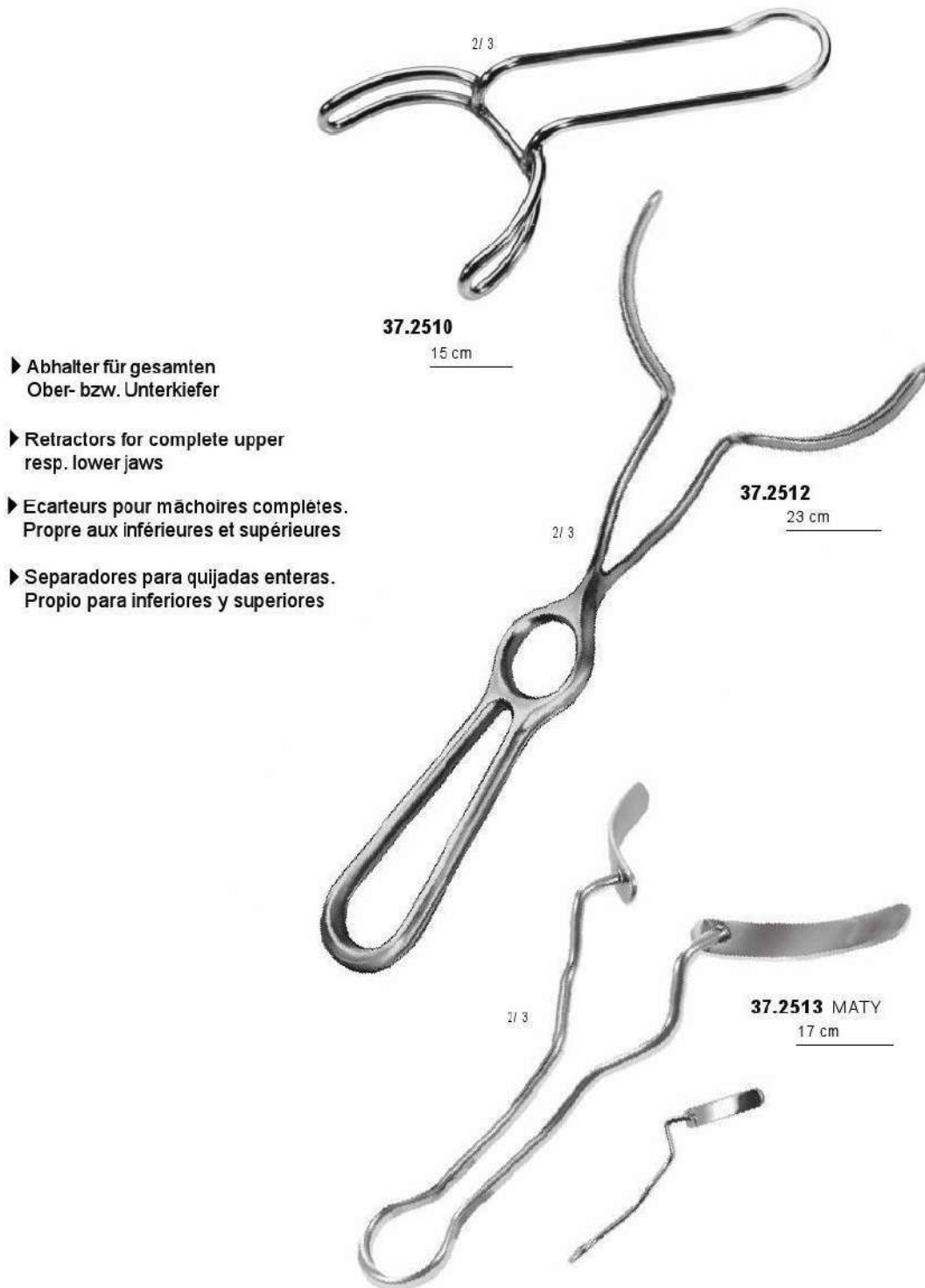

- ▶ Abhalter für gesamten Ober- bzw. Unterkiefer
- ▶ Retractors for complete upper resp. lower jaws
- ▶ Ecarteurs pour mâchoires complètes. Propre aux inférieures et supérieures
- ▶ Separadores para quijadas enteras. Propio para inferiores y superiores

37



37.2502-1 MIDDELDORPF
 17 mm



37.2502-2 MIDDELDORPF
 22 mm



37.2450 HILGER
 Abhalter, passend auf Mundspiegelgriffe
 Retractor, fits on mouth mirror handles
 Ecarteur, compatible avec manches de miroirs à bouche
 Separador, compatible con mangos para espejos intraorales



37.2332 LANGENBECK
 Fingerschützer
 Finger protector
 Protège-doigts
 Protector de dedos

37



37.2460 MINNESOTA
 16 cm



37.2462 STERNBERG
 16 cm



37.2470 ROUX
 17 cm

Mundsperrer
 Mouth gags
 Ouvre-bouches
 Abre-bocas

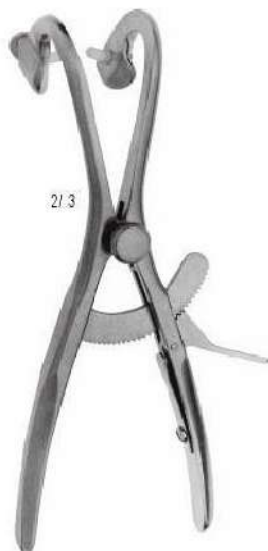

37.2205 DENTHART
 13 cm

37.2205-1



- 1 Paar Silikoneinlagen
- 1 pair of silicone inserts
- 1 paire de protecteurs silicones
- 1 pareja de silicón capas



37.2237 DOYEN-MOLT
 10 cm - für Kinder, for children, pour enfants, para niños, per bambini

37.2238 DOYEN-MOLT

- 12 cm - für Erwachsene, for adults, pour adulte, pai adulto, per adulto

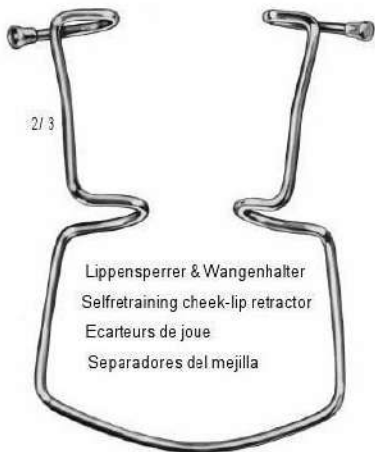

37.2465-1 ORINGER
 klein, small, petit, pequeno

37.2465-2 ORINGER
 mittel, medium, moyen, medio

37.2465-3 ORINGER
 groß, large, grand, grande



37.2338-1 WIEDER
 klein, small, petit, pequeno

37.2338-2 WIEDER
 groß, large, grand, grande



37.2334 BUCHWALD
 18 cm, Zungenspatel
 18 cm, tongue depressor
 18 cm, abaisse-langue
 18 cm, abat lengua

37

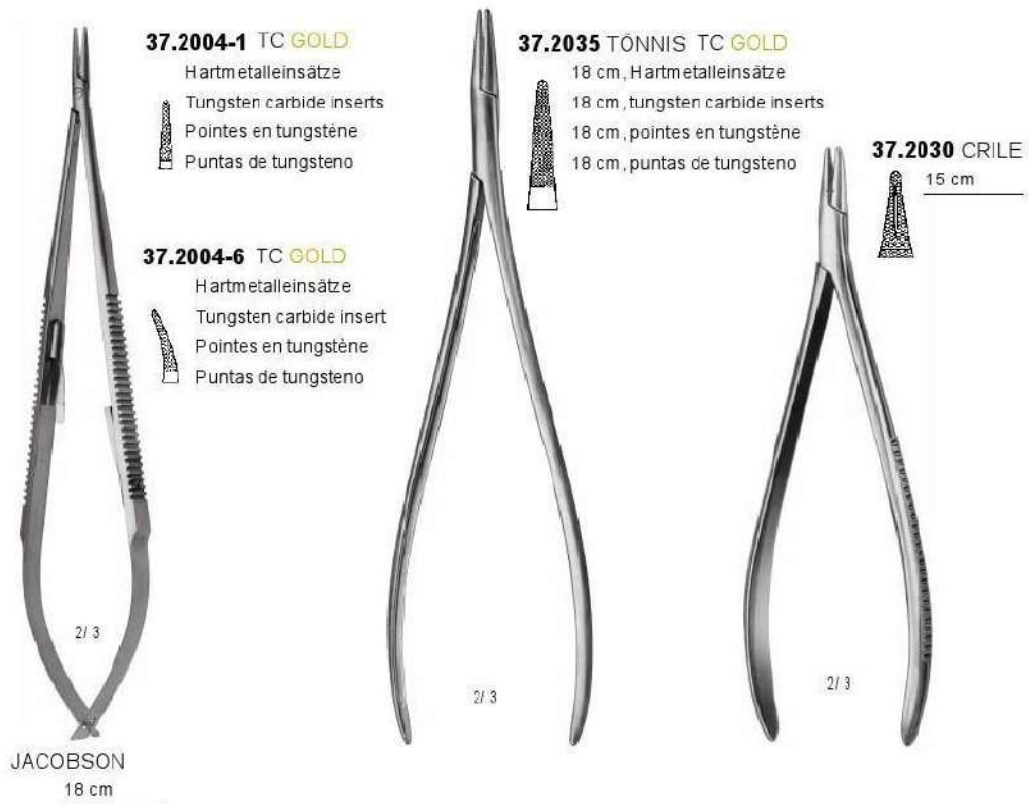

37

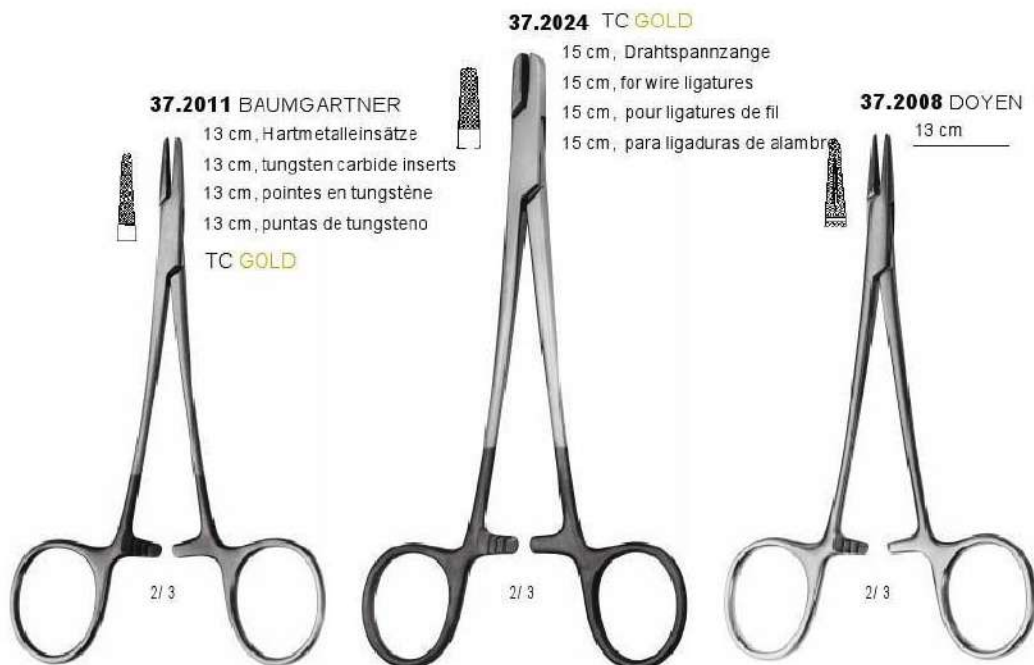

37

37.2012 CRILE-WOOD

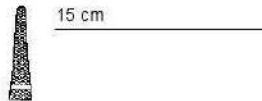

CRILE-WOOD

37.2014 CRILE-WOOD TC GOLD

- 15 cm, Hartmetalleinsätze
- 15 cm, tungsten carbide inserts
- 15 cm, pointes en tungstène
- 15 cm, puntas de tungsteno

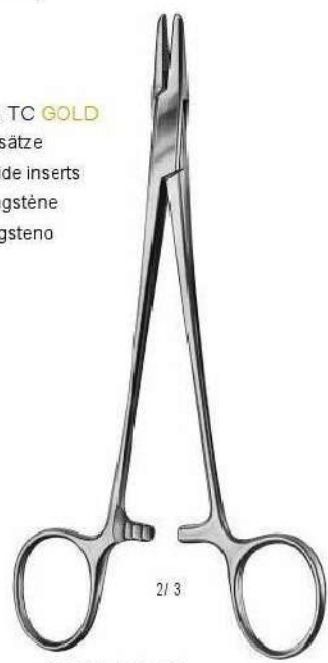

MAYO-HEGAR

37.2016-16

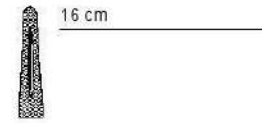

37.2018-16 TC GOLD

- 16 cm, Hartmetalleinsätze
- 16 cm, tungsten carbide inserts
- 16 cm, pointes en tungstène
- 16 cm, puntas de tungsteno



37.2016-18

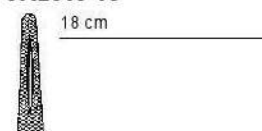

37.2018-18 TC GOLD

- 18 cm, Hartmetalleinsätze
- 18 cm, tungsten carbide inserts
- 18 cm, pointes en tungstène
- 18 cm, puntas de tungsteno



DE BAKAY

37.2020-16 TC GOLD

- 16 cm, Hartmetalleinsätze
- 16 cm, tungsten carbide inserts
- 16 cm, pointes en tungstène
- 16 cm, puntas de tungsteno



37.2020-18 TC GOLD

- 18 cm, Hartmetalleinsätze
- 18 cm, tungsten carbide inserts
- 18 cm, pointes en tungstène
- 18 cm, puntas de tungsteno



CRILE-RYDER

37.2022-13 TC GOLD

- 13 cm, Hartmetalleinsätze
- 13 cm, tungsten carbide inserts
- 13 cm, pointes en tungstène
- 13 cm, puntas de tungsteno



37.2022-15 TC GOLD

- 15 cm, Hartmetalleinsätze
- 15 cm, tungsten carbide inserts
- 15 cm, pointes en tungstène
- 15 cm, puntas de tungsteno



37.2022-18 TC GOLD

- 18 cm, Hartmetalleinsätze
- 18 cm, tungsten carbide inserts
- 18 cm, pointes en tungstène
- 18 cm, puntas de tungsteno



37

37.2012 CRILE-WOOD

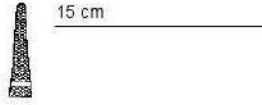

CRILE-WOOD

37.2014 CRILE-WOOD TC GOLD

- 15 cm, Hartmetalleinsätze
- 15 cm, tungsten carbide inserts
- 15 cm, pointes en tungstène
- 15 cm, puntas de tungsteno



MAYO-HEGAR

37.2016-16



37.2018-16 TC GOLD

- 16 cm, Hartmetalleinsätze
- 16 cm, tungsten carbide inserts
- 16 cm, pointes en tungstène
- 16 cm, puntas de tungsteno



37.2016-18



37.2018-18 TC GOLD

- 18 cm, Hartmetalleinsätze
- 18 cm, tungsten carbide inserts
- 18 cm, pointes en tungstène
- 18 cm, puntas de tungsteno



37.2020-16 TC GOLD

- 16 cm, Hartmetalleinsätze
- 16 cm, tungsten carbide inserts
- 16 cm, pointes en tungstène
- 16 cm, puntas de tungsteno

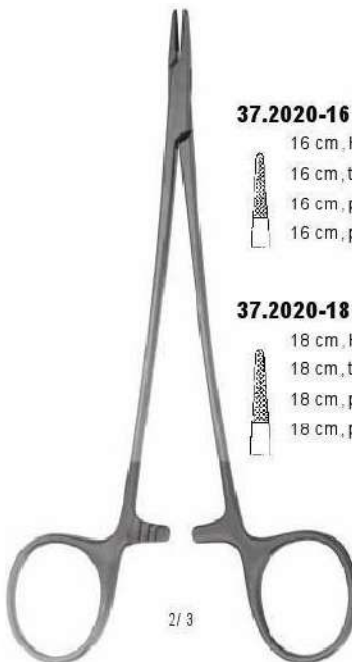

DE BAKAY

37.2020-18 TC GOLD

- 18 cm, Hartmetalleinsätze
- 18 cm, tungsten carbide inserts
- 18 cm, pointes en tungstène
- 18 cm, puntas de tungsteno



CRILE-RYDER

37.2022-13 TC GOLD

- 13 cm, Hartmetalleinsätze
- 13 cm, tungsten carbide inserts
- 13 cm, pointes en tungstène
- 13 cm, puntas de tungsteno



37.2022-15 TC GOLD

- 15 cm, Hartmetalleinsätze
- 15 cm, tungsten carbide inserts
- 15 cm, pointes en tungstène
- 15 cm, puntas de tungsteno



37.2022-18 TC GOLD

- 18 cm, Hartmetalleinsätze
- 18 cm, tungsten carbide inserts
- 18 cm, pointes en tungstène
- 18 cm, puntas de tungsteno





37.2050-12 BOYNTON
 12 cm, Hartmetalleinsätze
 12 cm, tungsten carbide inserts
 12 cm, mors en tungstène
 12 cm, puntas de tungsteno



37.2059 LICHTENBERG-RYDER
 14 cm, Hartmetalleinsätze
 14 cm, tungsten carbide inserts
 14 cm, pointes en tungstène
 14 cm, puntas de tungsteno

37.2062 MATHIEU-EISELSBERG
 19 cm



37



37.2052

37.2053

37.2057-1 TC GOLD
 Hartmetalleinsätze
 Tungsten carbide inserts
 Pointes en tungstène
 Puntas de tungsteno

37.2057 TC GOLD
 Hartmetalleinsätze
 Tungsten carbide inserts
 Pointes en tungstène
 Puntas de tungsteno



37.2054

37.2056

37.2058 TC GOLD
 Hartmetalleinsätze
 Tungsten carbide inserts
 Pointes en tungstène
 Puntas de tungsteno



2/3



37.2135-OG 2-5 ▼



37.2127-G 13-16 ▼

Nähnadeln mit Federöhr
 Suture needles with spring eye
 Aiguilles à suture avec chas à ressort
 Agujas para sutura con ojo de resorte



37

2/3



37.2150

Nadeldose, Ø 65 mm
 Needle case, Ø 65 mm
 Boîte à aiguilles, Ø 65 mm
 Cajita para agujas, Ø 65 mm

37.2150-1

Innendose gelocht
 Interior box punched
 Boîte à l'intérieur perforé
 Caja interior perforado



37.2110

Nahtpinzette
 Suture forceps
 Pince à suture
 Pinzas para sutura



2/3

Instrumentenbehälter
 Instrument trays
 Boîtes pour instruments
 Recipientes para instrumentos

37.2617-1

200 x 100 x 35 mm

37.2617-2

260 x 150 x 50 mm

37.2617-3

300 x 200 x 50 mm



2/3

Nierenschalen
 Kidney bowls
 Bassins réniformes
 Riñoneras

37.2619-1

170 x 100 x 35 mm

37.2619-2

250 x 140 x 40 mm

37.2619-3

275 x 150 x 45 mm

37



2/3

37.2610 METHOT
 Wattebehälter
 Cotton holder
 Récipient pour coton
 Algodonera



2/3

37.2613 METHOT
 für Watteabfälle
 waste receiver
 pour déchets de coton
 para desechos de algodón

Zylinder-Ampullen-Spritzen
 Cartridge syringes
 Seringues d'ampoules
 Jeringas de ampollas



Ohne Aspiration
 Without aspiration device
 Sans aspiration
 Sin aspiración

37

37.2666-18

1,8 cc

37.2666-22

2,2 cc

Metrisches Gewinde

Metric thread

Vis métrique

Rosca métrica

37.2666-18 US

1,8 cc

37.2666-22 US

2,2 cc

US-Gewinde

US-thread

Vis amérique

Rosca americana



Mit Aspiration
 With aspiration device
 Avec aspiration
 Con aspiración

37.2668-18

1,8 cc

37.2668-22

2,2 cc

Metrisches Gewinde

Metric thread

Vis métrique

Rosca métrica

37.2668-18 US

1,8 cc

37.2668-22 US

2,2 cc

US-Gewinde

US-thread

Vis amérique

Rosca americana



2/3

37.2716

10 cc

Wasserspritze selbstfüllend

Water syringe aspirating

Seringue à eau auto-aspirante

Jeringa de agua autoaspirante

Castroviejo Zirkel
 Castroviejo calipers
 Castroviejo étriers
 Castroviejo calibreadores



37.1730-1, 9 cm
 40 mm, gerade
 40 mm, straight
 40 mm, droit
 40 mm, recto



37.1730-6, 9 cm
 40 mm, 45° gewinkelt
 40 mm, 45° angled
 40 mm, 45°
 40 mm, 45°

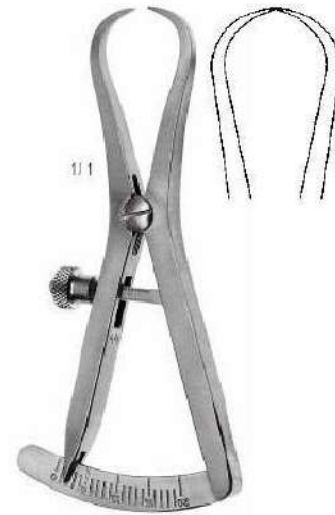

37.1730-4, 9 cm
 20 mm, für Implantat
 20 mm, for implants
 20 mm,
 20 mm,

37



37.1731-1, 18 cm
 40 mm, gerade
 40 mm, straight
 40 mm, droit
 40 mm, recto



37.1731-6, 18 cm
 40 mm, gewinkelt
 40 mm, angled
 40 mm,
 40 mm,

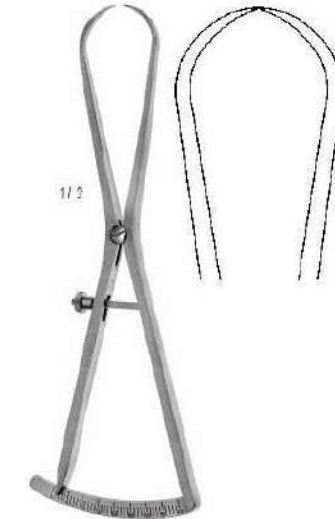

37.1731-4, 18 cm
 40 mm, für Implantat
 40 mm, for implants
 40 mm,
 40 mm,



38

DIAGNOSIS
DIAGNOSTIK
DIAGNOSTIC
DIAGNÓSTICO

Mundspiegelgriffe
 Mouth mirror handles
 Manches à miroirs
 Mangos a espejos



38.2770

Serviettenhalter, Länge verstellbar
 Napkin holder, length variable
 Porte-serviette, longueur changeable
 Porta-servilleta, tamaño variable



38.2780



38.2782



38.2783



38.2784

hohl
 hollow
 creux
 hueco



38.2786-1 ECONOMY

hohl
 hollow
 creux
 hueco



38.2787

hohl
 hollow
 creux
 hueco

38

38.2804-4 RHODIUM

plan
 plane
 plan
 plano

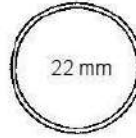

38.2805-4 RHODIUM

vergrößend
 magnifying
 agrandissant
 de aumento

38.2804-5 RHODIUM

plan
 plane
 plan
 plano

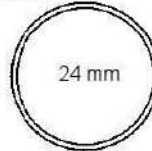

38.2805-5 RHODIUM

vergrößend
 magnifying
 agrandissant
 de aumento

38

► Scharfes + verzerrungsfreies Spiegelbild durch reflektierende Metallschicht direkt auf der Glasoberfläche

► Sharp + distortion free mirror image through reflective metal layer directly on glass surface



38.2808-3 RHODIUM MICRO

3 mm



38.2808-5 RHODIUM MICRO

5 mm



38.2808-36 RHODIUM MICRO

3 x 6 mm

38.2806-4 RHODIUM

Mega-Spiegel - plan, Fig. 4
 Mega mirror - plane, Fig. 4
 Mega miroir - plan, Fig. 4
 Mega espejo - plano, Fig. 4



38.2800-3

plan
 plane
 plan
 plano

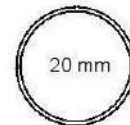

38.2800-4

plan
 plane
 plan
 plano

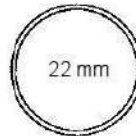

38.2801-4

vergrößend
 magnifying
 agrandissant
 de aumento



STANDARD

38.2800-5

plan
 plane
 plan
 plano

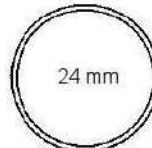

38.2801-5

vergrößend
 magnifying
 agrandissant
 de aumento

Diamantierte Spitzen zum Entfernen von Fremdkörpern
Diamonded tips for removing foreign bodies
Pointes diamantées pour écarter corps étrangers
Puntas diamantadas para sacar cuerpos extraños

- ▶ **Überlegene Rostsicherheit** durch extra polierte Schweißnaht
- ▶ **Sicherer Schluß auch unter Druck** durch besonderen Stopstift
- ▶ **Superior corrosion resistance** through specially polished weld
- ▶ **Secure closing even under pressure** through special stopping pin
- ▶ **Meilleur résistance à la rouille** par une soudure fourbie spécialement
- ▶ **Fermeture assurée même sous compression** par un arrêt spécial
- ▶ **Mejor protección contra el moho** por una soldadura pulida
- ▶ **Cierra seguramente aun con compresión** por una espiga particular



38.2885 COLLEGE	38.2886 COLLEGE	38.2887 COLLEGE	38.2888 COLLEGE
gerieft	feine Spitzen	kräftige Spitzen	diamantierte Spitzen
serrated	fine tips	strong tips	diamonded tips
striée	pointes fines	pointes robustes	pointes diamantées
estriada	puntas finas	puntas fuertes	puntas diamantadas



verhindert das Übereinandergleiten der Spitzen
 prevents side-slipping of tips
 évite le glissement latéral des pointes
 evita que las puntas se desvien al lado

38



- | | | | | | |
|--|---|--|---|---|---|
| 38.2884 COLLEGE
glatt
smooth
lisse
lisa | 38.2889 COLLEGE
geniert mit Schloß
serrated with ratchet
striée avec arrêt
estriada con cierre | 38.2880 COLLEGE
glatt
smooth
lisse
lisa | 38.2881 COLLEGE
geniert
serrated
striée
estriada | 38.2883 COLLEGE
geniert
serrated
striée
estriada | 38.2988
für Silberspitzen
for silver points
pour cônes d'argent
para puntas de plata |
|--|---|--|---|---|---|

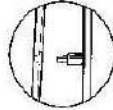

verhindert das Übereinandergleiten der Spitzen
 prevents side-slipping of tips
 évite le glissement latéral des pointes
 evita que las puntas se desvien al lado

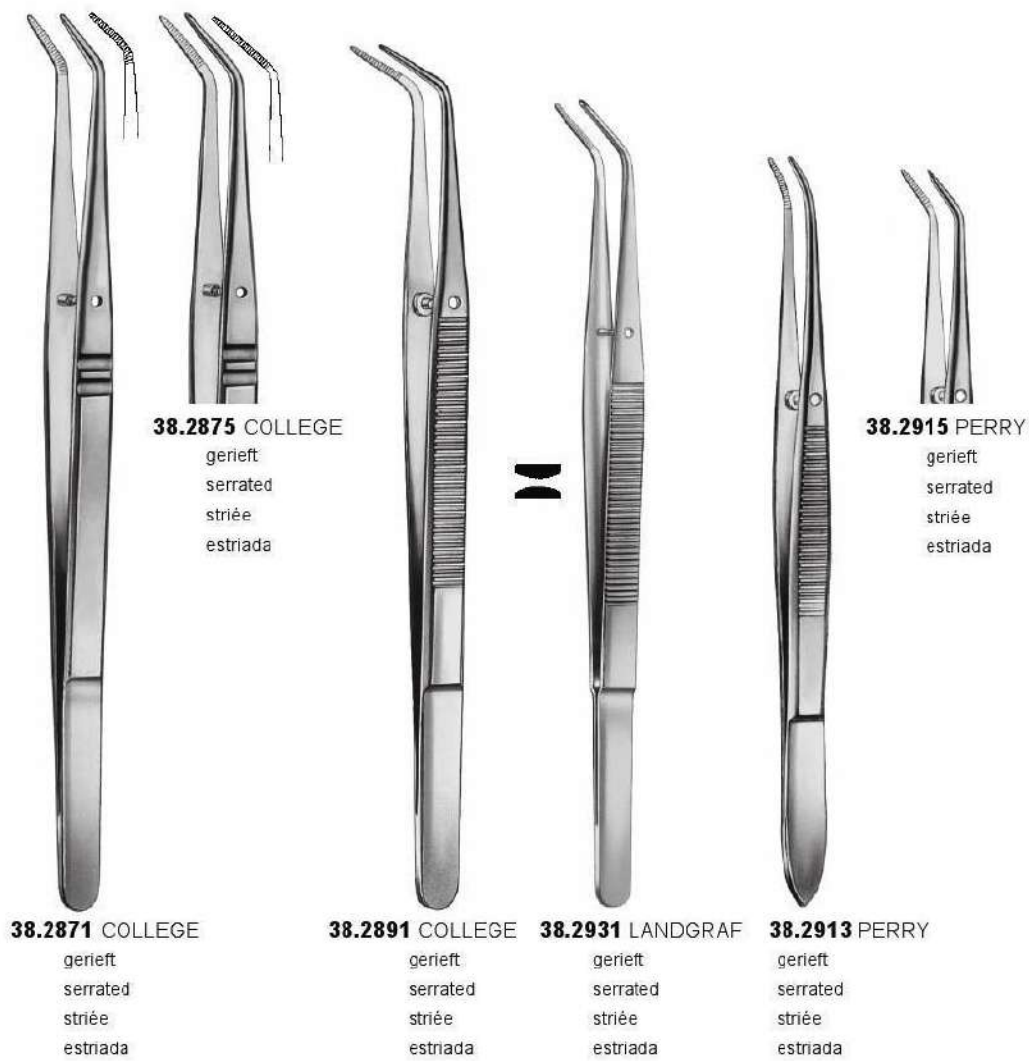

38.2875 COLLEGE
 gerieft
 serrated
 striée
 estriada

38.2915 PERRY
 gerieft
 serrated
 striée
 estriada

38.2871 COLLEGE
 gerieft
 serrated
 striée
 estriada

38.2891 COLLEGE
 gerieft
 serrated
 striée
 estriada

38.2931 LANDGRAF
 gerieft
 serrated
 striée
 estriada

38.2913 PERRY
 gerieft
 serrated
 striée
 estriada

38

38

Diamantierte Spitzen zum Entfernen von Fremdkörpern
Diamonded tips for removing foreign bodies
Pointes diamantées pour écarter corps étrangers
Puntas diamantadas para sacar cuerpos extraños



38.2921 FLAGG
gerieft
serrated
striée
estriada

38.2943 MERIAM
gerieft
serrated
striée
estriada

38.2942 MERIAM
glatt
smooth
lisse
lisa

38.2948 MERIAM
diamantierte Spitzen
diamonded tips
pointes diamantées
puntas diamantadas

38.2959 MERIAM
gerieft
serrated
striée
estriada

Zahnsonden
 Explorers
 Sondes
 Sondas

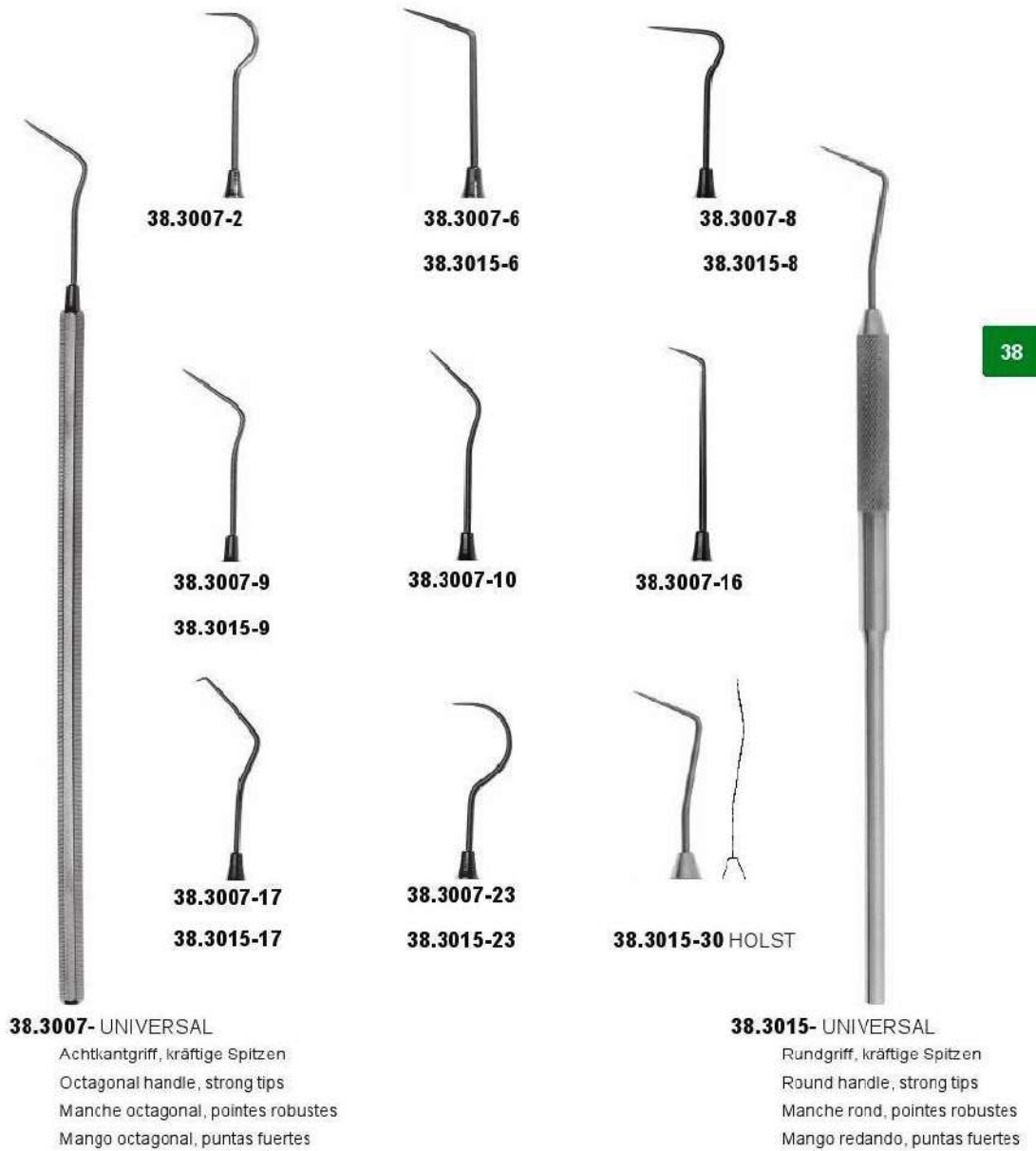

38

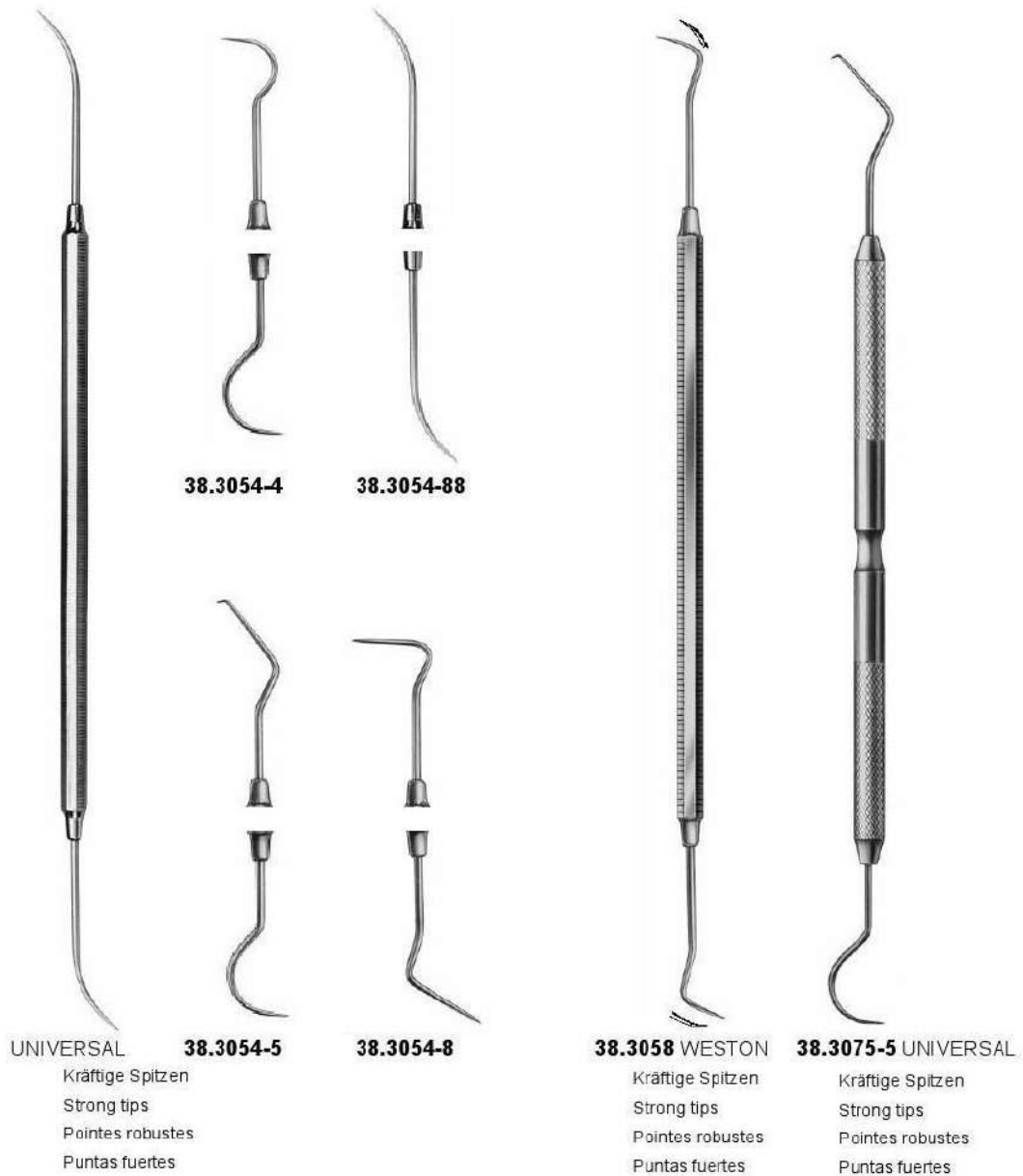

► **Extrem feine und flexible Spitzen**
 aus einer Speziallegierung ermöglichen das Ertasten kleinster Defekte

► **Very delicate and flexible tips**
 made from a special alloy allow for detection of smallest defects

► **Un bout très pointu et flexible**
 fabriqué d'un alliage spécial permet la découverte des plus petits défauts

► **Puntas muy delgadas y flexibles**
 fabricadas de una aleación especial facilitan el descubrimiento de defectos pequeños



OPTIFLEX

Sehr feine Spitzen
 Very fine tips
 Pointes très fines
 Puntas muy finas



38.3016-8 OPTIFLEX



38.3016-9 OPTIFLEX

38



38.3016-17 OPTIFLEX



38.3016-23 OPTIFLEX

38

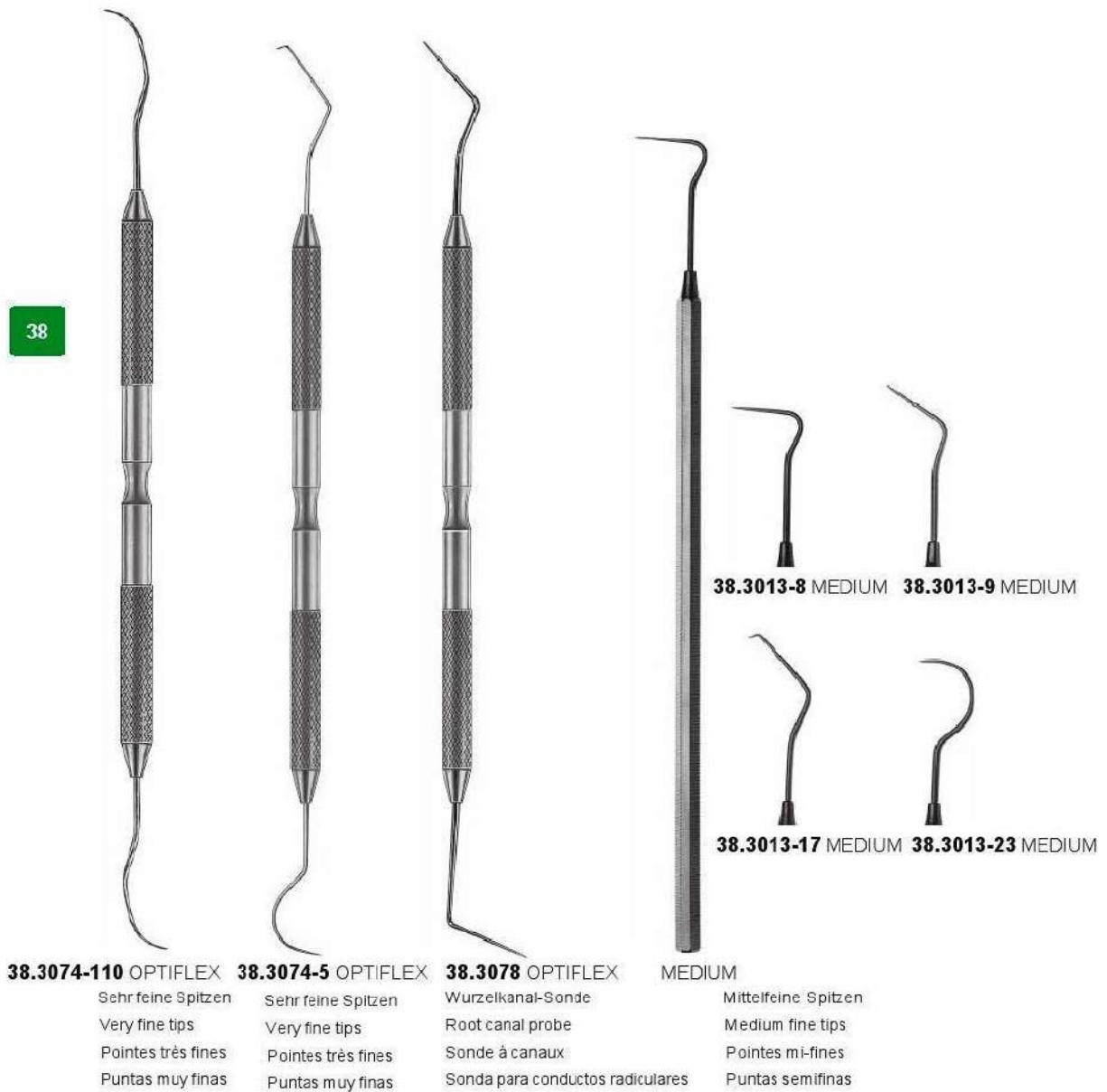

Parodontal-Sonden
 Periodontal probes
 Sondes parodontales
 Sondas paradontales



38.3077-2 NABERS
 Fig. Q2N

38.3076

38.3410 WHO

38.3410-1 WHO

38.3412 WILLIAMS

38.3418
 Fig. CP10

38

Parodontal-Sonden
 Periodontal probes
 Sondes parodontales
 Sondas paradontales

38

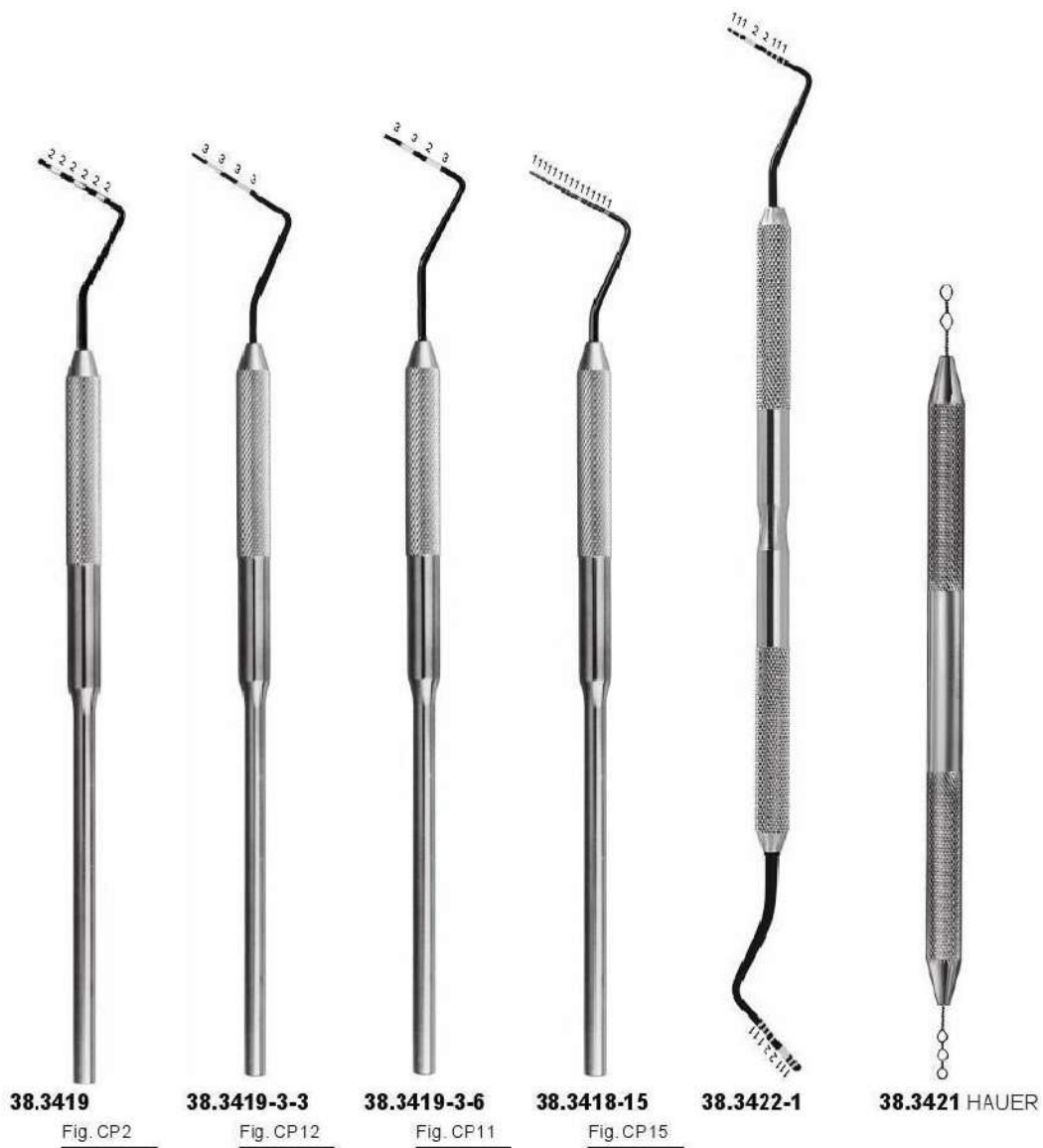



39

PERIODONTIA
PARODONTOLOGIE
PARODONTOLOGIE
PERIODONCIA

ANWENDUNG KÜNRETTE

Oberkiefer
 Upper jaw
 Mâchoire supérieure
 Maxilar superior

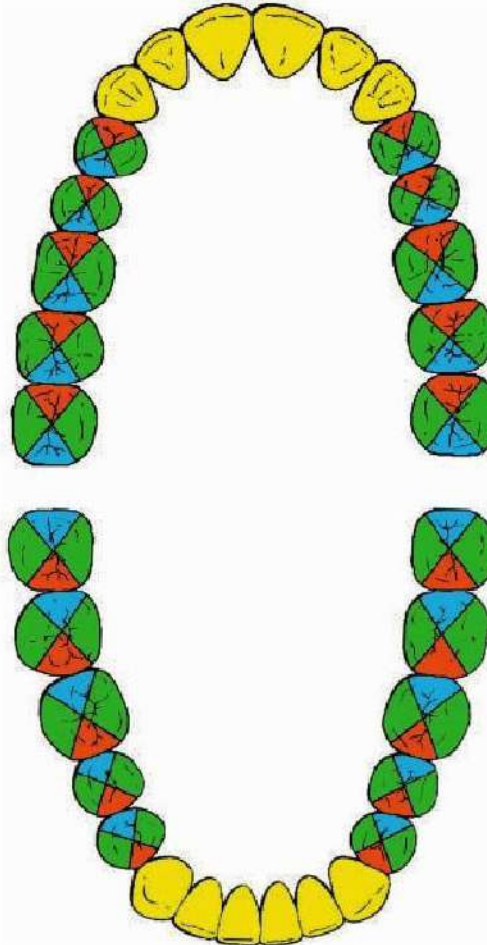

39

Unterkiefer
 Lower jaw
 Mâchoire inférieure
 Maxilar inferior

- Fig. 1/2 oder Fig. 5/6
- Fig. 7/8 oder Fig. 9/10
- Fig. 11/12 oder Fig. 15/16
- Fig. 13/14 oder Fig. 17/18

Zahnreiniger
 Scalers
 Instruments à détartrer
 Limpiadores de sarro

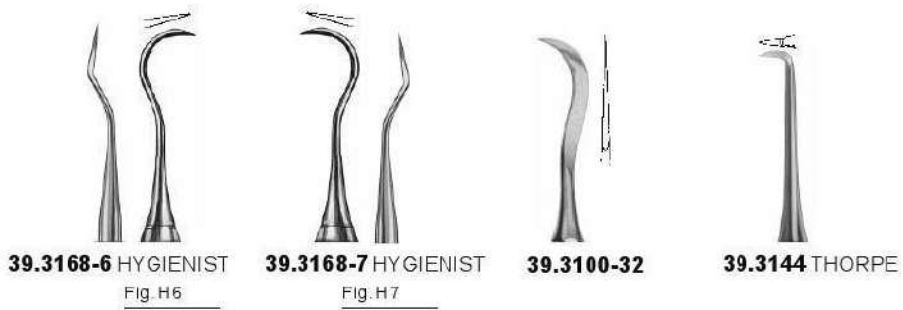
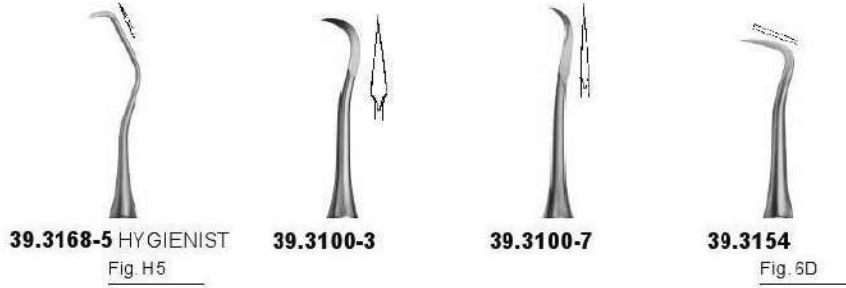
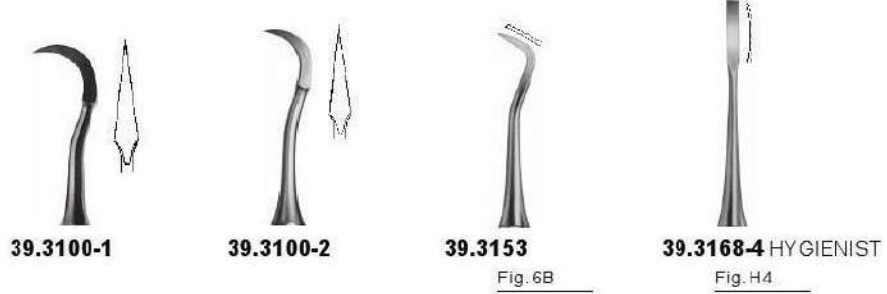

39

Zahnreiniger
 Scalers
 Instruments à détartrer
 Limpiadores de sarro

39



39.3169-1 HYGIENIST **39.3169-12** HYGIENIST
 Fig. H5



39.3169-6 HYGIENIST **39.3169-7** HYGIENIST
 Fig. H6 Fig. H7



39.3253 CUMINE



39.3254 MITCHELL
 Osteotrimmer

Zahnreiner
 Scalers
 Instruments à détartrer
 Limpiadores de sarro

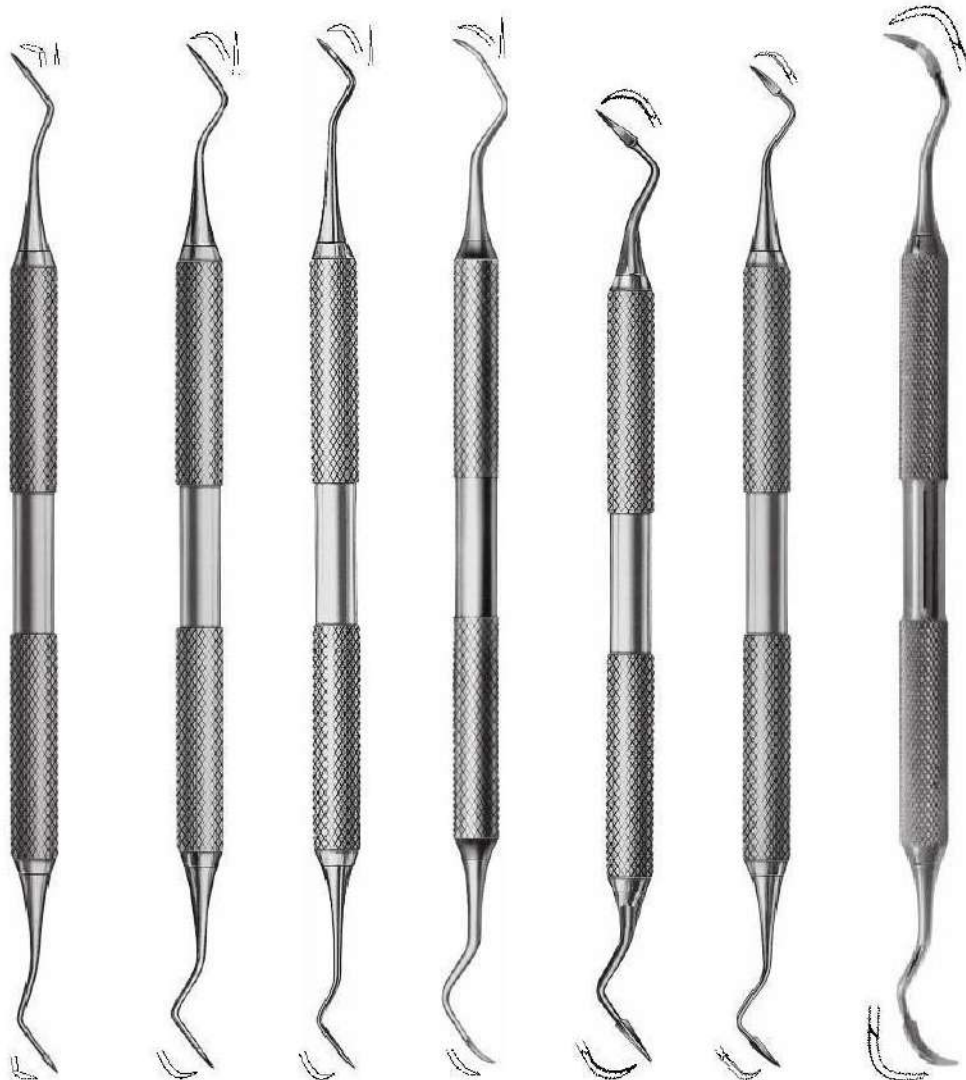

39

39.3274-1 JACQUETTE **39.3274-2** **39.3274-204** **39.3380-139** **39.3275** **39.3275-23** TAYLOR **39.3276** CRANE-KAPLAN
 Fig. 34/35 Fig. 204 S Fig. IU 13/14 Fig. 2/3 Fig. 2/3 Fig. 6

Zahnreiniger
 Scalers
 Instruments à détartrer
 Limpiadores de sarro

39

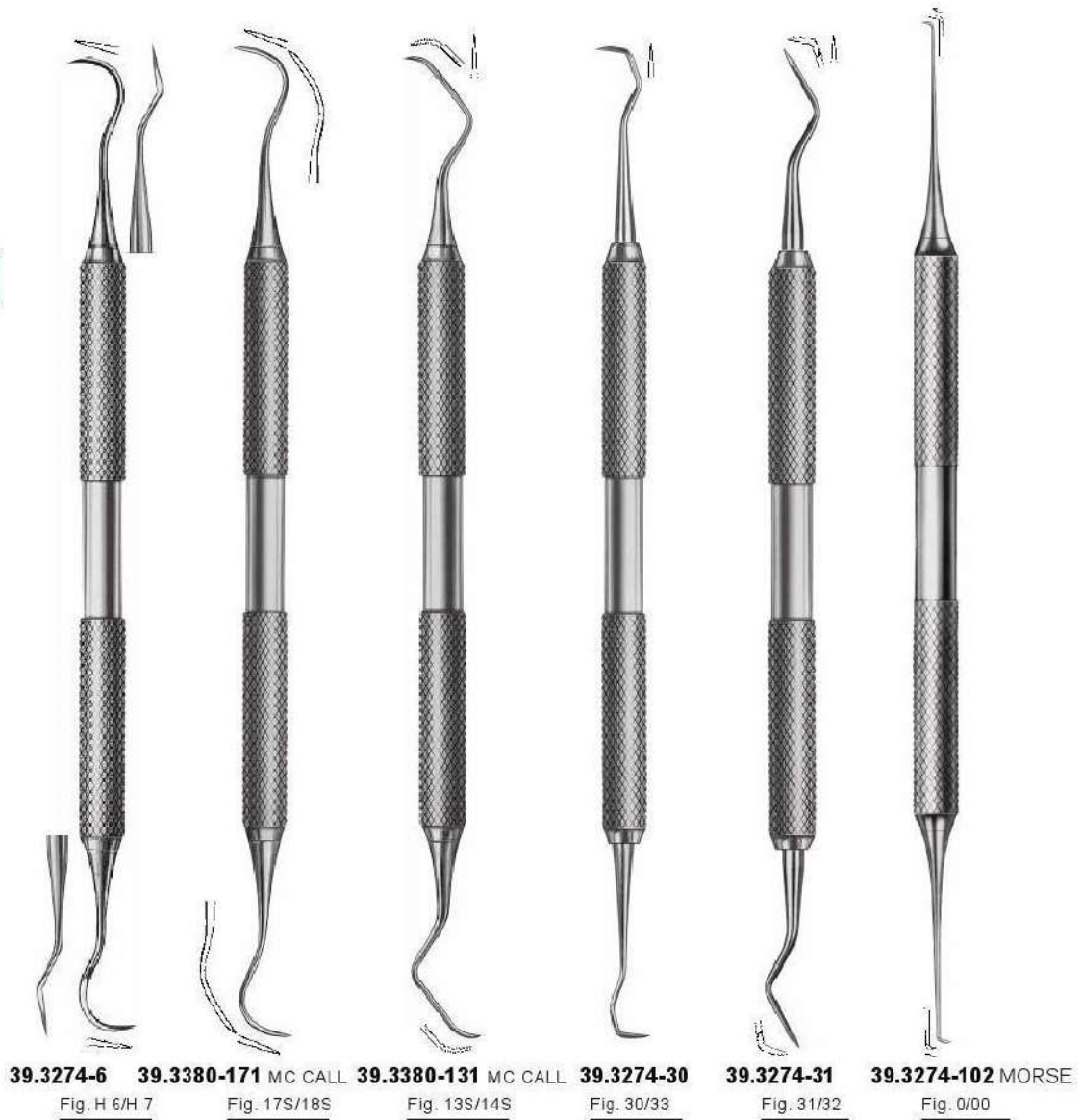

Zahnreiniger
 Scalers
 Instruments à détartrer
 Limpiadores de sarro



Küretten mit Farbring
 Curettes with colour ring
 Curettes avec anneaux de couleurs
 Curetas con anillo del color

39



GRACEY



39.3374-1 GRACEY

Fig. 1/2

1 - 3



39.3374-3 GRACEY

Fig. 3/4

1 - 5



39.3374-5 GRACEY

Fig. 5/6

1 - 5



39.3374-7 GRACEY

Fig. 7/8

lingual + buccal
 4 - 8



39.3374-9

Fig. 9/10

lingual + buccal
 4 - 8



39.3374-11

Fig. 11/12

mesial
 4 - 8



39.3374-13

Fig. 13/14

distal
 4 - 8



39.3374-15

Fig. 15/16

mesial
 4 - 8



39.3374-17

Fig. 17/18

distal
 4 - 8

Farbringe für GRACEY Küretten
 Colour rings for GRACEY curettes
 Anneaux de couleurs pour GRACEY curettes
 Anillo del color para GRACEY curetas

- ▶ Zur Kodierung der Instrumente mit Farbringen
- ▶ 9 Farben
- ▶ Sterilisierbar bis zu 170°C (338°F)
- ▶ Hergestellt aus Silikon

- ▶ For color-coding instruments
- ▶ 9 colors
- ▶ Sterilizable up to 170°C (338°F)
- ▶ Made of silicone rubber

- | | |
|---|--|
|  | 39.3360-1 grau/grey
P. of 50 pcs. |
|  | 39.3360-3 schwarz/black
P. of 50 pcs. |
|  | 39.3360-5 gelb/yellow
P. of 50 pcs. |
|  | 39.3360-7 grün/green
P. of 50 pcs. |
|  | 39.3360-9 rot/red
P. of 50 pcs. |
|  | 39.3360-11 orange/orange
P. of 50 pcs. |
|  | 39.3360-13 blau/blue
P. of 50 pcs. |
|  | 39.3360-15 braun/brown
P. of 50 pcs. |
|  | 39.3360-17 weiss/white
P. of 50 pcs. |



39

Küretten
 Currettes
 Curettes
 Curetas

39

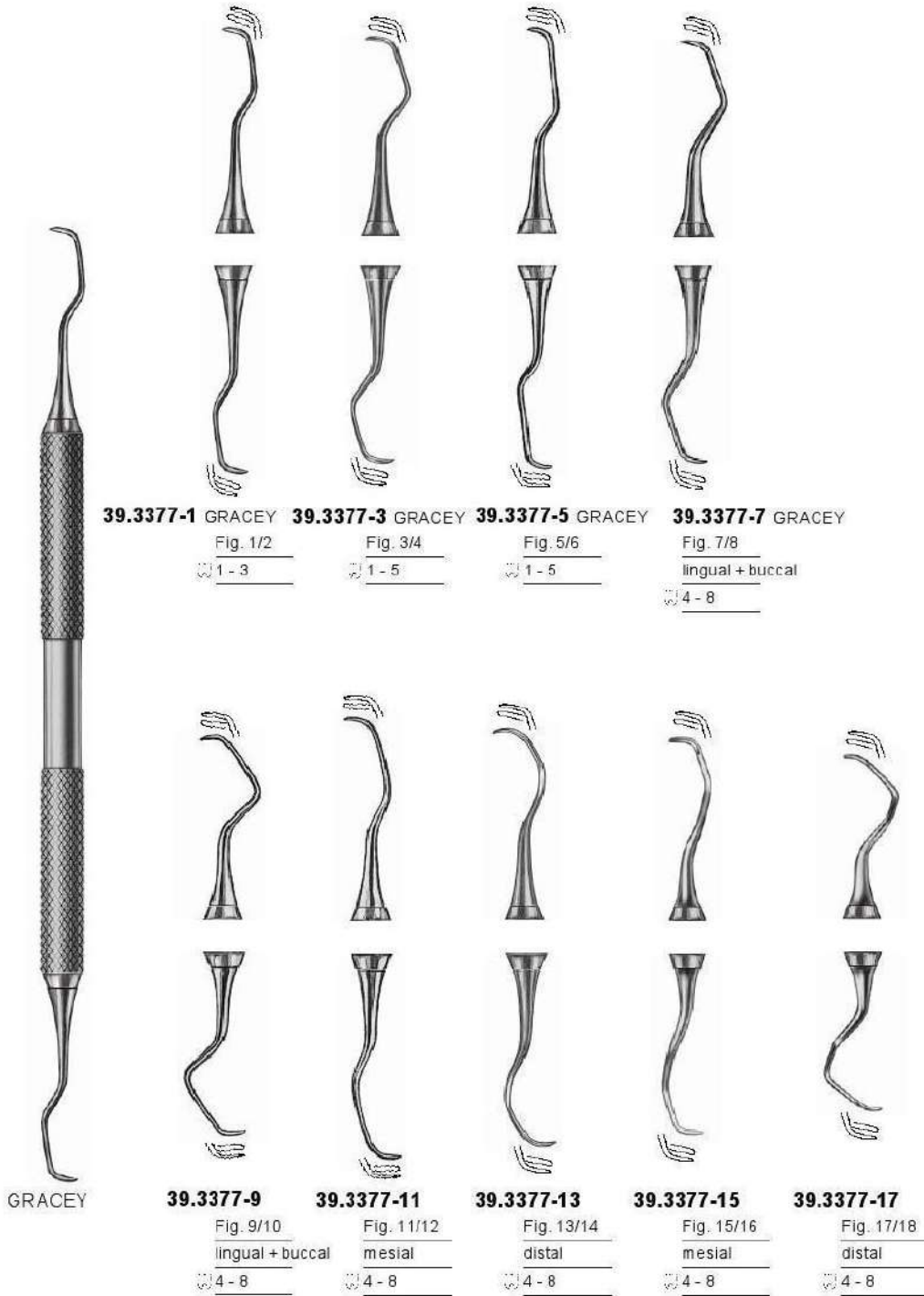



39.3375-5 GRACEY COLOR

Fig. 5/6

1 - 5



39.3375-7 GRACEY COLOR

Fig. 7/8

lingual + buccal

4 - 8

39



39.3375-11 GRACEY COLOR

Fig. 11/12

mesial

4 - 8



39.3375-13 GRACEY COLOR

Fig. 13/14

distal

4 - 8

Für tiefe Taschen, Miniatur
 For deep pockets, Miniatur
 Pour poches profondes, Miniature
 Para bolsas profundas, Miniatur

39

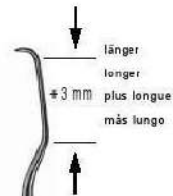

GRACEY
 miniatur

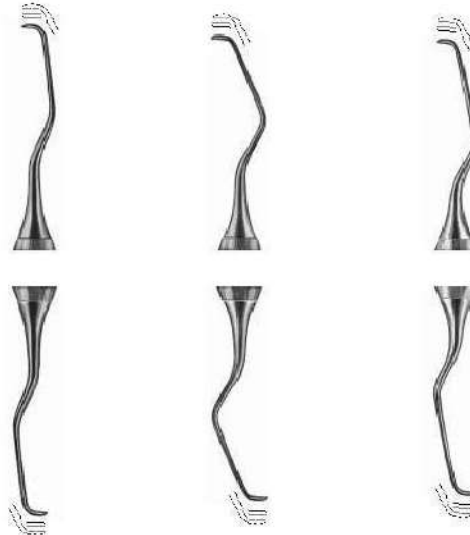

39.3377-101 GRACEY
 Fig. 1/2, miniatur
 1 - 3

39.3377-103 GRACEY
 Fig. 3/4, miniatur
 1 - 5

39.3377-105 GRACEY
 Fig. 5/6, miniatur
 1 - 5

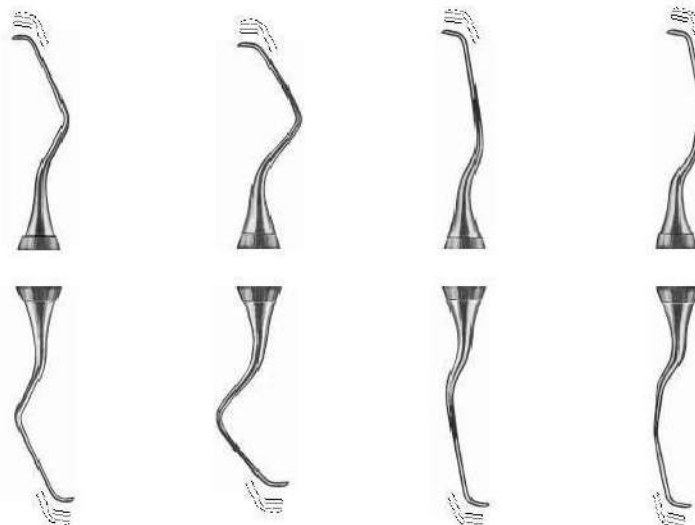

39.3377-107
 Fig. 7/8, miniatur
 lingual + buccal
 4 - 8

39.3377-109
 Fig. 9/10, miniatur
 lingual + buccal
 4 - 8

39.3377-111
 Fig. 11/12, miniatur
 mesial
 4 - 8

39.3377-113
 Fig. 13/14, miniatur
 distal
 4 - 8

Furchungsküretten
Curettes for root depressions
Curettes pour dépressions radicaire
Curetas para depresiones en la raiz

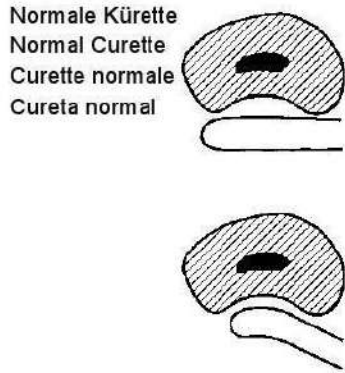

- ▶ Optimale Reinigung/Glättung vertikaler Wurzeleinziehungen
- ▶ Optimal planing of vertical depressions on root surfaces
- ▶ Curettage optimal de dépressions verticales sur la surface des racines
- ▶ Óptima limpieza de contracciones verticales en la superficie de la raiz



39

39.3372-11 GEURTSSEN-GÜNAY

Fig. 11/12
 mesial
 4 - 8

39.3372-13 GEURTSSEN-GÜNAY

Fig. 13/14
 distal
 6 - 8

Universalküretten
 Universal curettes
 Curettes universelles
 Curetas universales

39

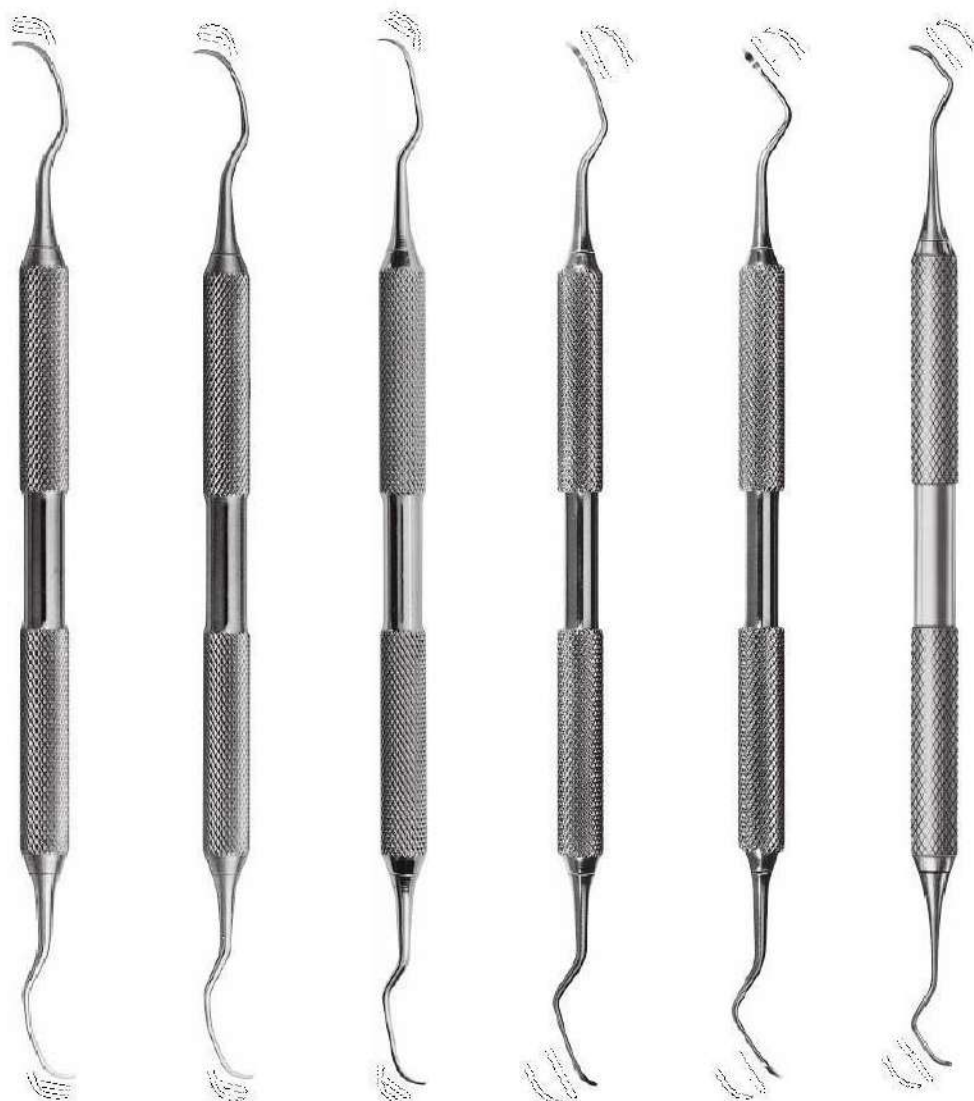

39.3377-91 LANGER	39.3377-93 LANGER	39.3377-95 LANGER	39.3379-2 COLUMBIA	39.3379-4 COLUMBIA	39.3379-13 COLUMBIA
Fig. L 1/2	Fig. L 3/4	Fig. L 5/6	Fig. 2L/2R	Fig. 4L/4R	Fig. 13/14
34 - 38 44 - 48	14 - 18 24 - 28	1 - 3	1 - 6	6 - 8	6 - 8 Wurzeln - roots racines - raices



39

- ▶ Schnellwechsel ohne Werkzeug
- ▶ Spitzen stehen automatisch in richtiger Position
- ▶ Abgedichteter Verschluß

- ▶ Fast tip change without tools
- ▶ Tips are automatically aligned in correct position
- ▶ Sealed closure

- ▶ Remplacement rapide des points sans aucun outil
- ▶ Pointes tenues toujours en position correcte
- ▶ Fermeture étanchée

- ▶ Rápido cambio sin utensilios
- ▶ Puntas siempre alineadas en posición correcta
- ▶ Atornillado empaquetado

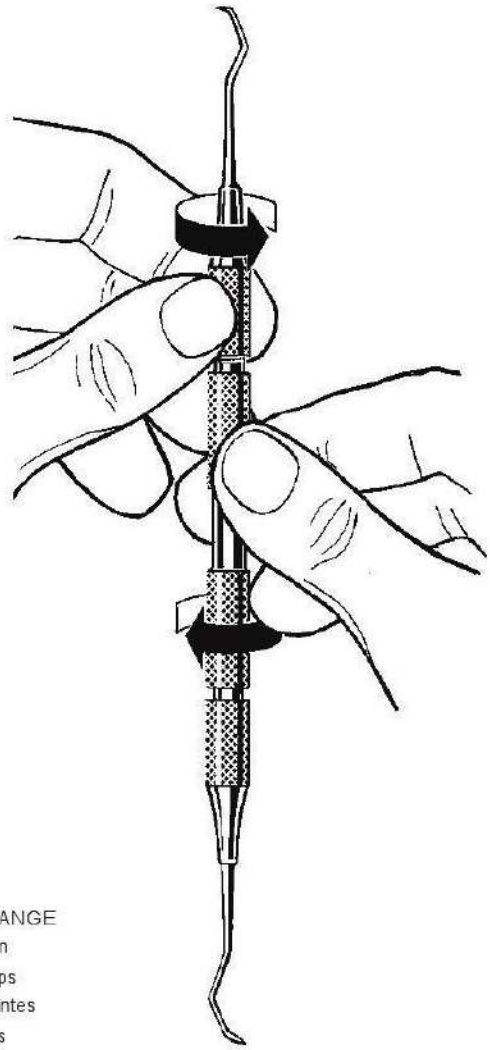

39.3330 QUICK-CHANGE

Griff ohne Spitzen
 Handle without tips
 Manche sans pointes
 Mango sin puntas

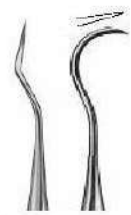

39.3334-6 HYGIENIST

Fig. H6
 Spitze · tip · pointe
 punta



39.3334-7 HYGIENIST

Fig. H7
 Spitze · tip · pointe
 punta



39.3334-22

Fig. 2
 Spitze · tip · pointe
 punta



39.3334-23

Fig. 3
 Spitze · tip · pointe
 punta

QUICK-CHANGE



39.3347-5 GRACEY

Fig. 5
 Spitze · tip · pointe
 punta



39.3347-6 GRACEY

Fig. 6
 Spitze · tip · pointe
 punta



39.3347-7 GRACEY

Fig. 7
 Spitze · tip · pointe
 punta



39.3347-8 GRACEY

Fig. 8
 Spitze · tip · pointe
 punta

39



39.3347-11 GRACEY

Fig. 11
 Spitze · tip · pointe
 punta



39.3347-12 GRACEY

Fig. 12
 Spitze · tip · pointe
 punta



39.3347-13 GRACEY

Fig. 13
 Spitze · tip · pointe
 punta



39.3347-14 GRACEY

Fig. 14
 Spitze · tip · pointe
 punta



39.3340-13 MC CALL

Fig. 13
 Spitze · tip · pointe
 punta



39.3340-14 MC CALL

Fig. 14
 Spitze · tip · pointe
 punta



39.3340-17 MC CALL

Fig. 17
 Spitze · tip · pointe
 punta



39.3340-18 MC CALL

Fig. 18
 Spitze · tip · point
 punta

Parodontalmesser
 Gingivectomy knives
 Bistouris pour la gingivectomie
 Bisturios para la gingivectomía

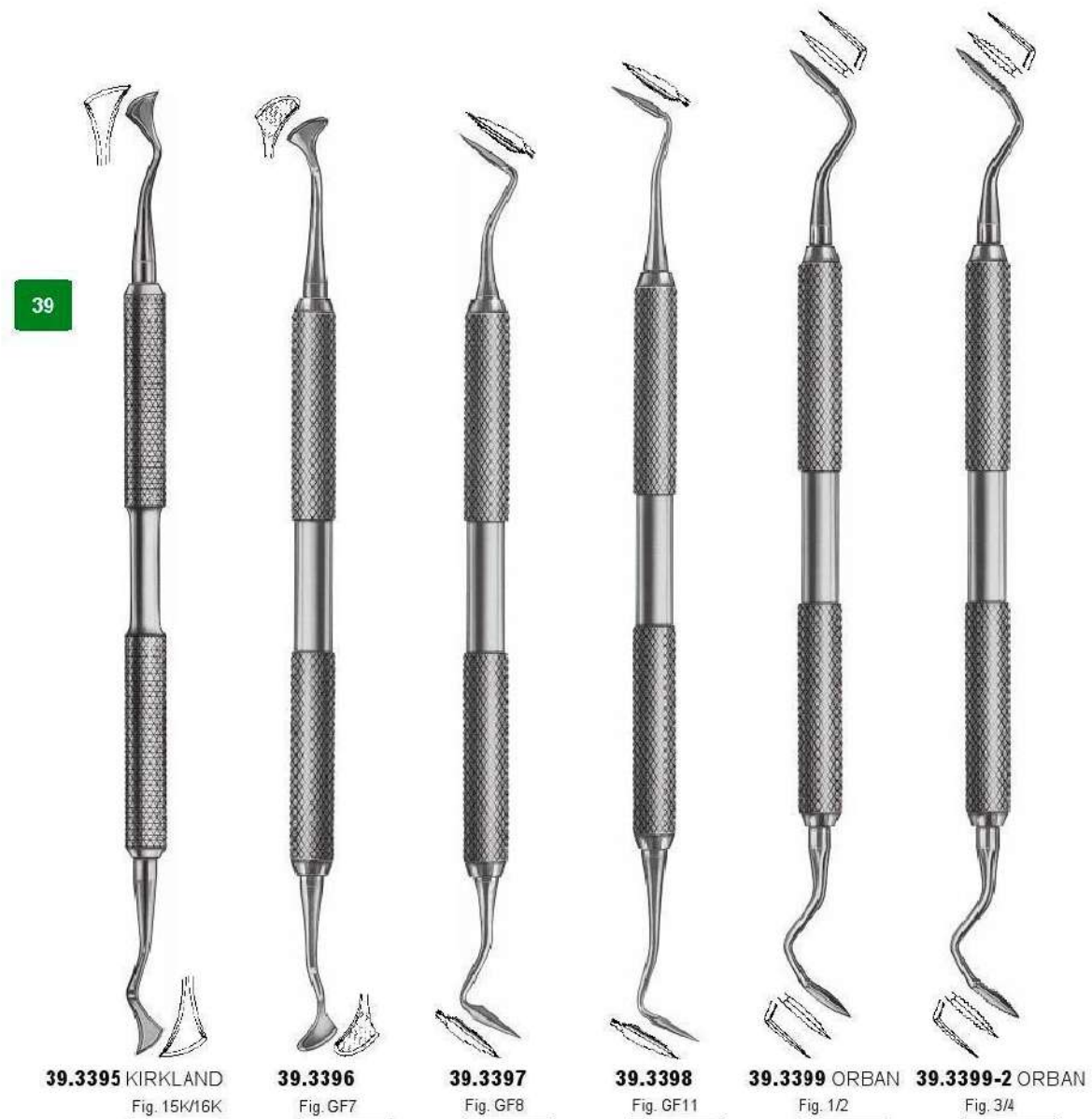

Zur Gewebeerntfernung
 For removing tissue
 Pour retirer le tissu
 Para quitar el tejido

Feilen
 Files
 Limes
 Limas

Gewebezangchen
 Tissue nippers
 Pincers  couper le tissu
 Pinzas para cortar tejidos



39.3378
 Fig. GF9



39.3232 HIRSCHFELD
 Fig. 3/7



39.3232-2 HIRSCHFELD
 Fig. 5/11



39.3233-9 SCHLUGER
 Fig. 9/10



39.3438-10 COHEN
 10 cm

39.3438-16 SUGARMAN
 16 cm



39.3439-10 COHEN
 10 cm

39.3439-13 ILIC
 13 cm

39

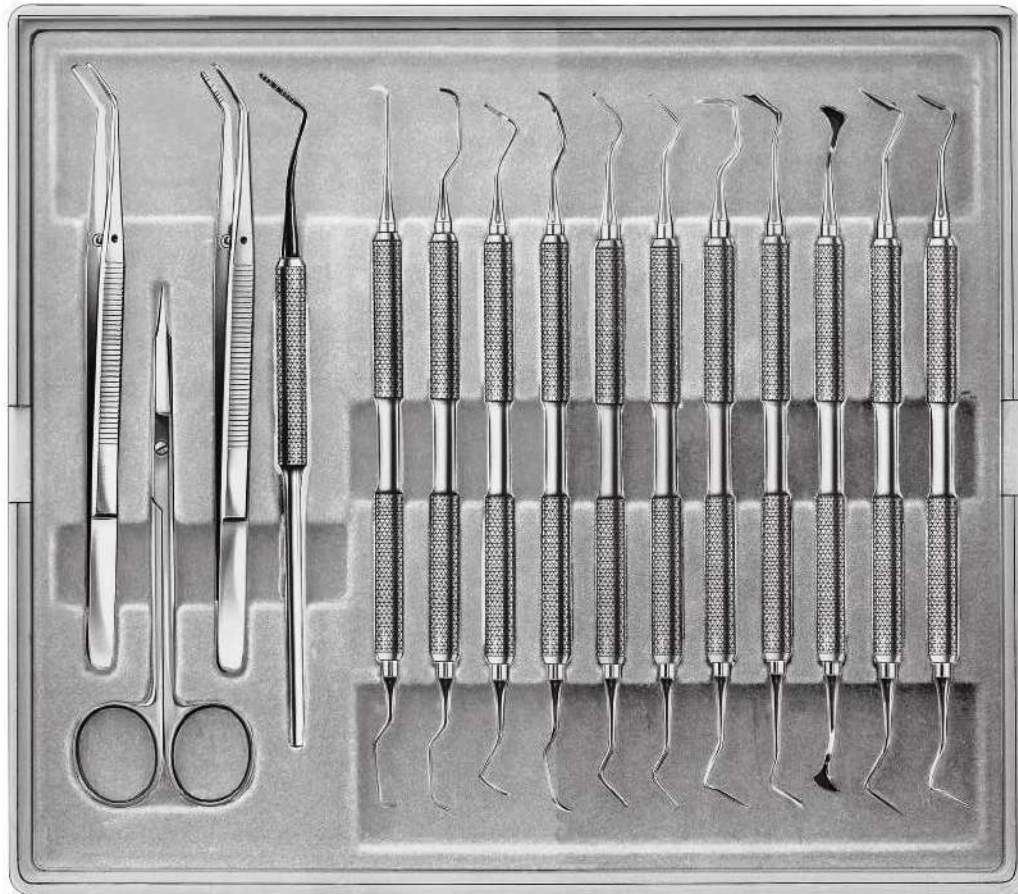

39.3426-1 + 39.3426-2

39.1117

39.3418

-1

-2

-3

-4

-5

-6

39.3378

39.3383

39.3396

39.3397

39.3398

39.3376-

39.3382 GOLDMANN-FOX- SET

kompletter Sat

complete set

jeu complet

estuche completo

- ▶ Preiswerter Schutz von PA-Instrumenten
- ▶ Geeignet für alle üblichen Hygieneverfahren
- ▶ Paßt genau in Normtrays

- ▶ Economical protection of periodontal instruments
- ▶ Suited for all common hygienical processes
- ▶ Fits exactly into standard trays

- ▶ Protection économique d'instruments parodontaux
- ▶ Propre à toute procédure hygiénique usuelle
- ▶ Mésures ajustées au plateaux standards

- ▶ Protección de instrumentos parodontales a buen precio
- ▶ Propio para toda operación higiénica usual
- ▶ Proporciones ajustadas para estuches estandard



39.2598 PROTECTOR

für 5 Instrumente, 3 Rahmen pro Normtray
 for 5 instruments, 3 racks per standard tray
 pour 5 instruments, 3 cadres par plateau standar
 para 5 instrumentos, 3 cuadros por estuches estandard



39.2598-10 PROTECTOR

für 10 Instrumente, 2 Rahmen pro Normtray
 for 10 instruments, 2 racks per standard tray
 pour 10 instruments, 2 cadres par plateau standard
 para 10 instrumentos, 2 cuadros por estuches estandard

39



39.1700-510

für 22 Instrumente, 275 x 175 x 25 mm
 for 22 instruments, 275 x 175 x 25 mm
 pour 22 instruments, 275 x 175 x 25 mm
 para 22 instrumentos, 275 x 175 x 25 mm



40

CONSERVATIVE
KONSERVIERENDE
CONSERVATRICE
CONSERVACIÓN

Schmelzmeißel
 Enamel chisels
 Ciseaux à émail
 Cinceles para esmalte

Gingivalrandschräger
 Gingival margin trimmers
 Finisseurs à bords gingivaux
 Recortadores del margen gingival

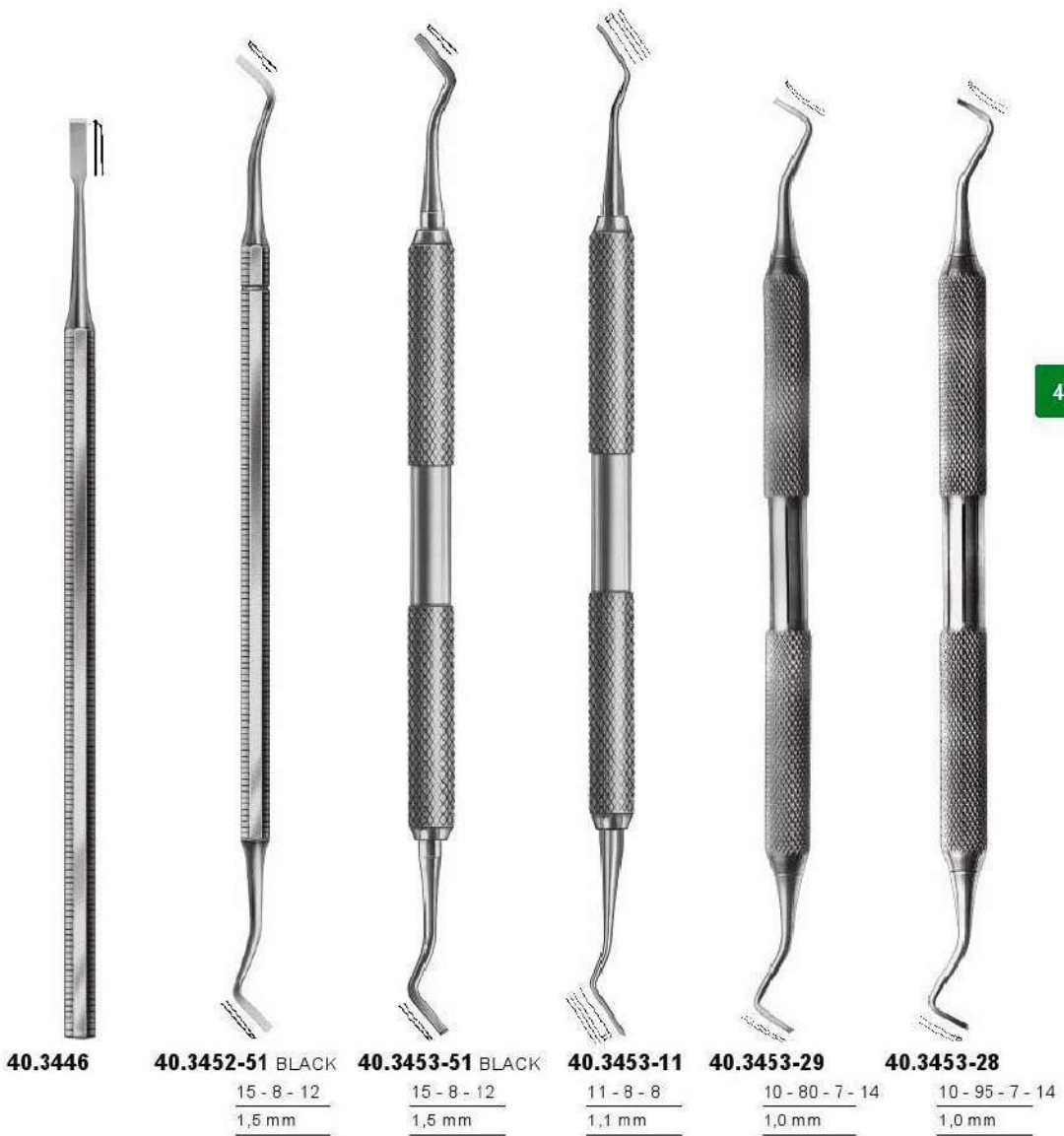

Gingivalrandschräger
 Gingival margin trimmers
 Finisseurs à bords gingivaux
 Recortadores del margen gingival

40

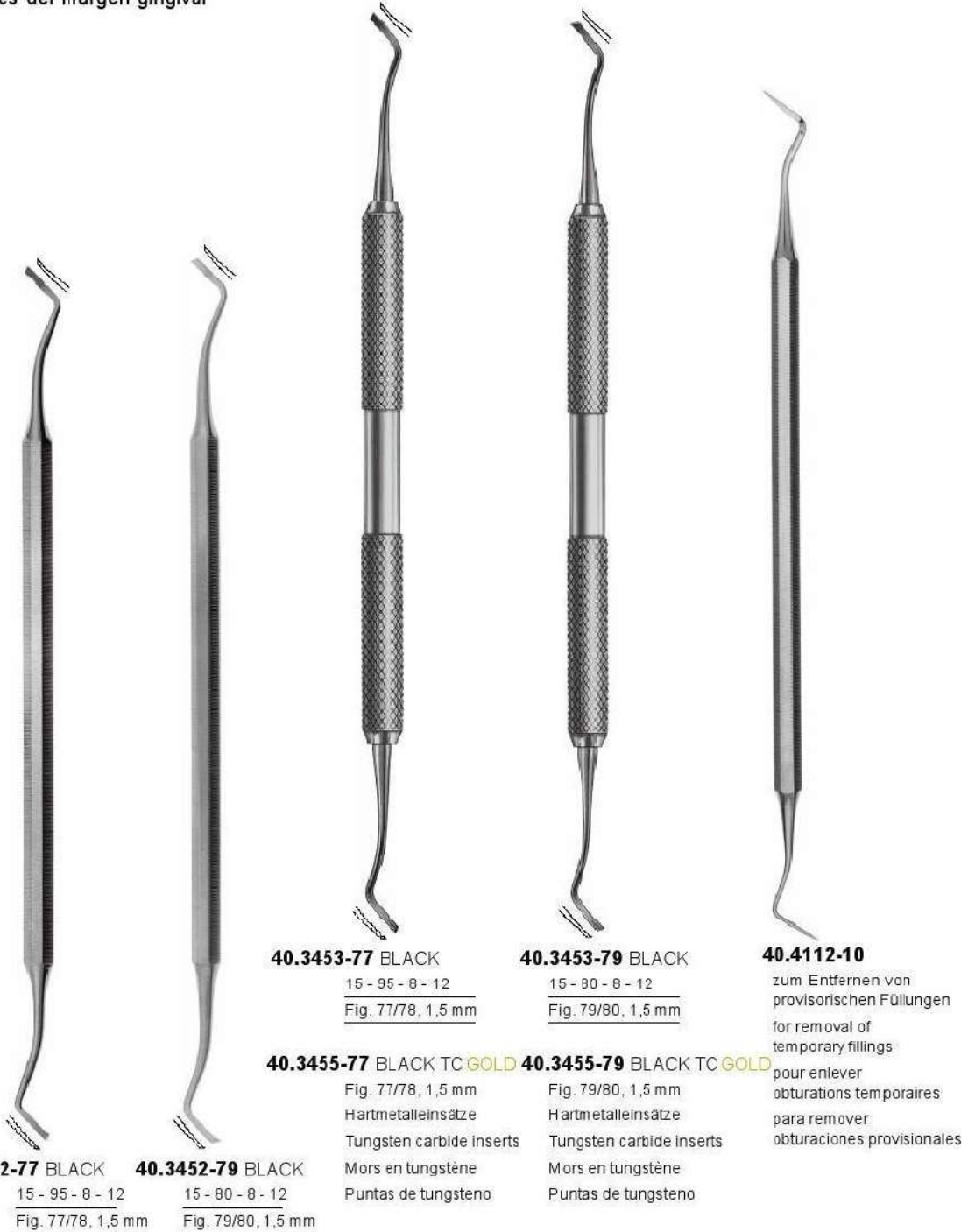

40.3452-77 BLACK 15 - 95 - 8 - 12
 Fig. 77/78, 1,5 mm

40.3452-79 BLACK 15 - 80 - 8 - 12
 Fig. 79/80, 1,5 mm

40.3453-77 BLACK 15 - 95 - 8 - 12
 Fig. 77/78, 1,5 mm

40.3453-79 BLACK 15 - 80 - 8 - 12
 Fig. 79/80, 1,5 mm

40.3455-77 BLACK TC GOLD Fig. 77/78, 1,5 mm
 Hartmetalleinsätze
 Tungsten carbide inserts
 Mors en tungstène
 Puntas de tungsteno

40.3455-79 BLACK TC GOLD Fig. 79/80, 1,5 mm
 Hartmetalleinsätze
 Tungsten carbide inserts
 Mors en tungstène
 Puntas de tungsteno

40.4112-10
 zum Entfernen von
 provisorischen Füllungen
 for removal of
 temporary fillings
 pour enlever
 obturations temporaires
 para remover
 obturaciones provisionales

Exkavatoren
 Excavators
 Excavateurs
 Excavadores

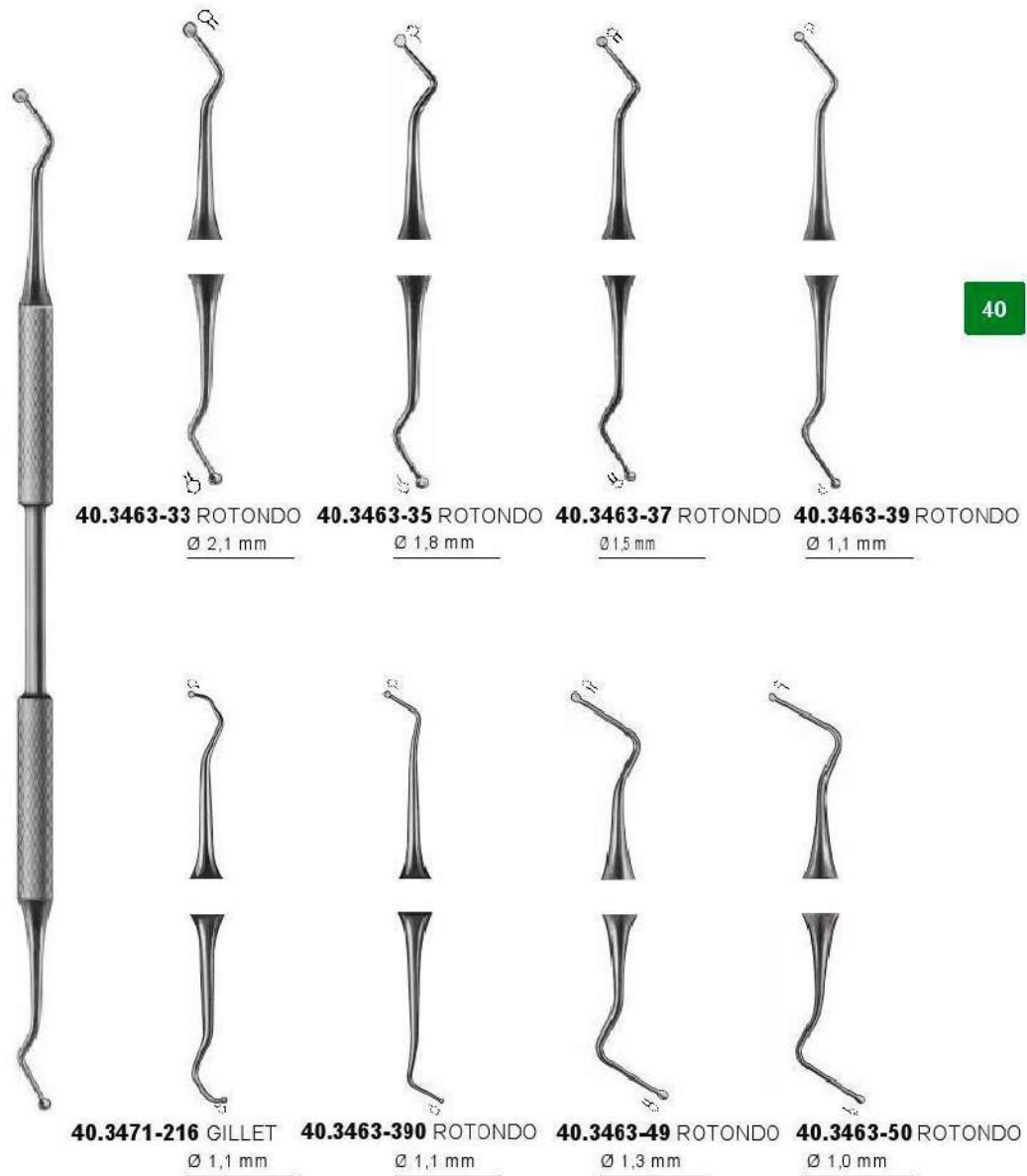

Exkavatoren
 Excavators
 Excavateurs
 Excavadores

40

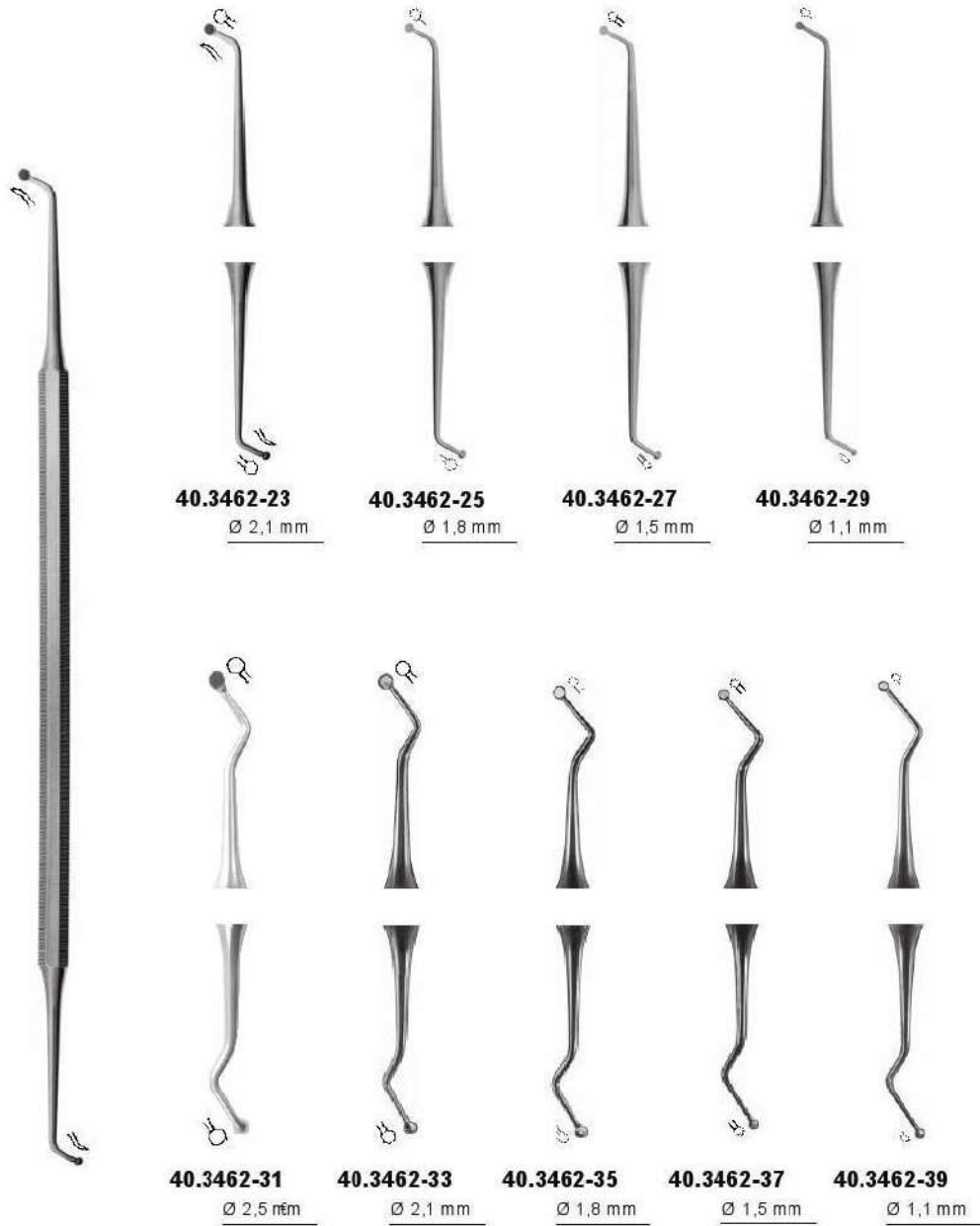

Exkavatoren
 Excavators
 Excavateurs
 Excavadores



40.3462-43

Ø 2,1 mm



40.3462-45

Ø 1,8 mm



40.3462-47

Ø 1,5 mm



40.3462-49

Ø 1,1 mm



40.3462-53

Ø 2,1 mm



40.3462-55

Ø 1,8 mm



40.3462-57

Ø 1,5 mm



40.3462-59

Ø 1,1 mm



40

Exkavatoren
 Excavators
 Excavateurs
 Excavadores

40

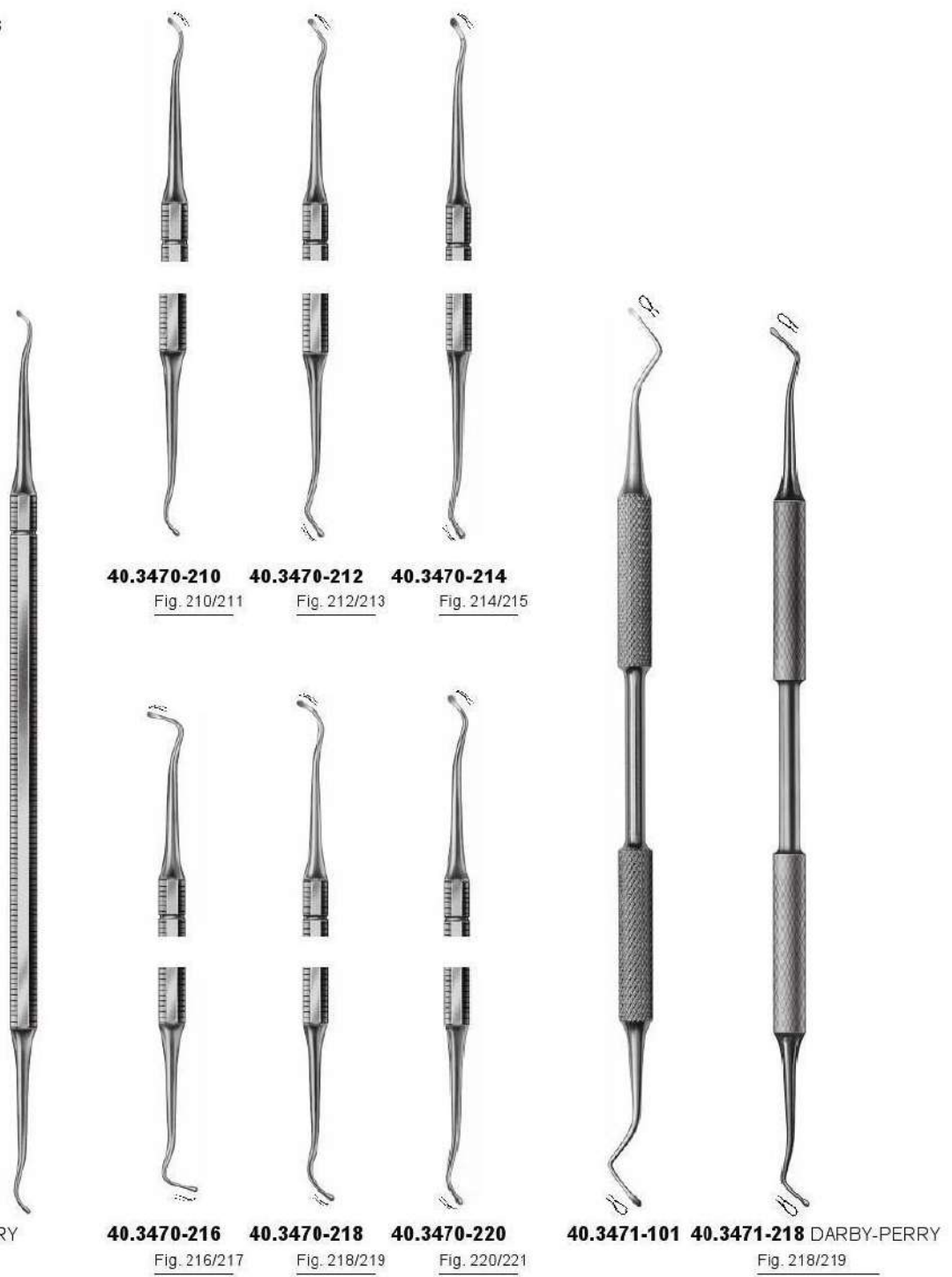

DARBY-PERRY

40.3470-210 **40.3470-212** **40.3470-214**
 Fig. 210/211 Fig. 212/213 Fig. 214/215

40.3470-216 **40.3470-218** **40.3470-220**
 Fig. 216/217 Fig. 218/219 Fig. 220/221

40.3471-101 **40.3471-218** DARBY-PERRY
 Fig. 218/219

Exkavatoren
 Excavators
 Excavateurs
 Excavadores

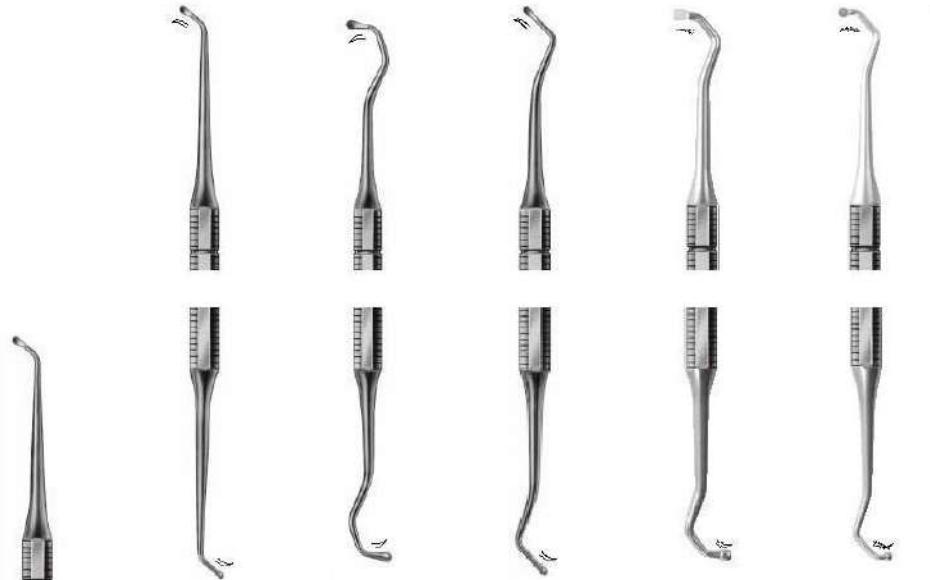

40

40.3476-5 **40.3476-14** **40.3476-17** **40.3462-244** **40.3462-245**
 Ø 1,4 mm Ø 2,0 mm



40.3476-18 **40.3476-19** **40.3476-20** **40.3452-63 BLACK** **40.3452-65 BLACK**
 Fig. 63/64 Fig. 65/66

matrizenspanner una matrizen
 Matrix retainers and matrixes
 Porte-Matrices et matrices
 Portamatrices y matrices

40



40.3581 IVORY



40.3582 IVORY



40.3583



40.3605 IVORY

Separator
 Separator
 Séparateur
 Separador



40.3585 FIG. 8
5 mm



40.3588-1 NYSTRÖM
6 mm



40.3588-2
6 mm



40.3590 TOFFLEMIRE
Universal



40.3590-1
Junior



40.3590-2
Senior

40.3587 FIG. 8
7 mm

Amalgampistolen
Amalgam carriers
Porte-amalgames
Porta amalgamas



40.3760

Stößel für Amalgampistolen
 Replacement plunger for amalgam carriers
 Poussoir pour porte-amalgames
 Émbolo para porta amalgamas

bis 140°C sterilisierbar
 sterilisation up to 140°C
 stérilisables jusqu'à 140°C
 esterilización hasta 140°C



40.3761

15 cm

40.3761-1

Ersatzspitzen aus Metall
 Metal replacement tips
 Pointes de rechange en métal
 Puntas de recambio de metal



40.3762

15 cm

40.3762-1

Ersatzspitzen aus Kunststoff
 Plastic replacement tips
 Pointes de rechange en plastique
 Puntas de recambio de plástico



40.3765

13 cm

40.3765-1

Ersatzspitzen aus Metall
 Metal replacement tips
 Pointes de rechange en métal
 Puntas de recambio de metal



40

40



40.3767

18 cm

40.3767-1



Ersatzspitzen aus Kunststoff
 Plastic replacement tips
 Pointes de rechange en plastique
 Puntas de recambio de plástico



40.3768 IVORY

16 cm



40.3740

Plombierhammer, 19 cm, 180 g, bleigefüllt
 Plugging mallet, 19 cm, 180 g, lead filled
 Maillet pour aurification, 19 cm, 180 g, rempli de plomb
 Martillo para orificaciones, 19 cm, 180 g, relleno de plomo



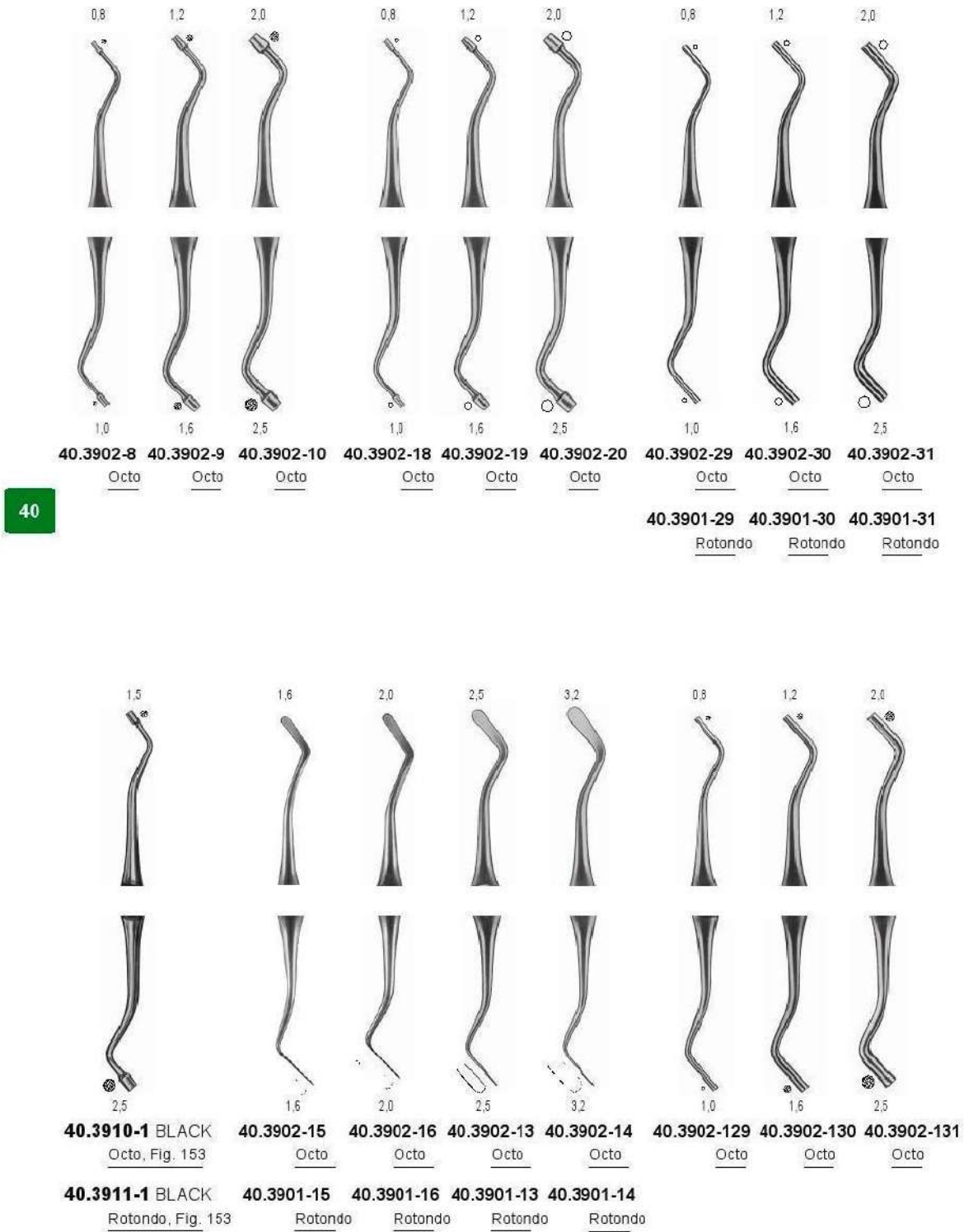

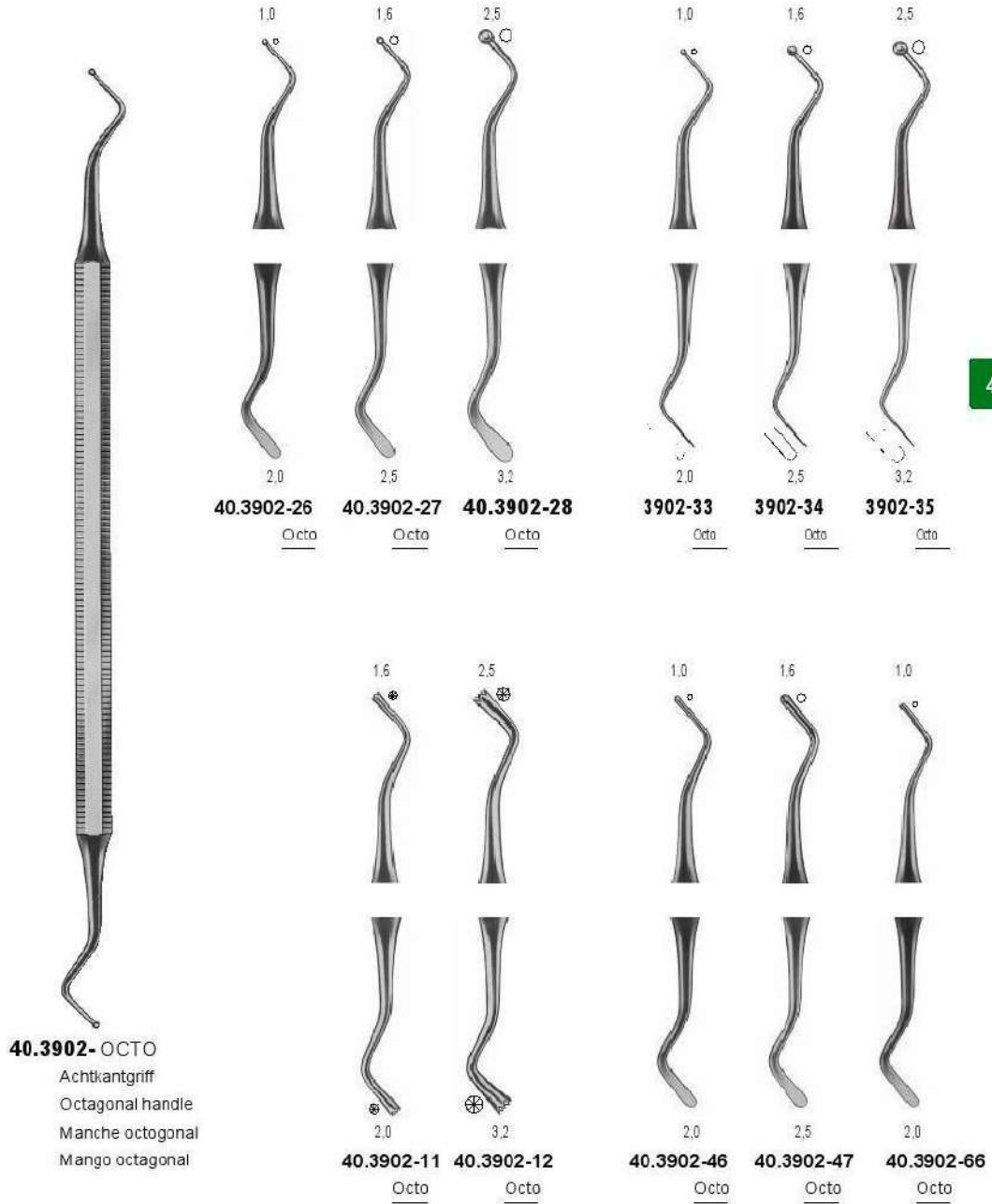

40

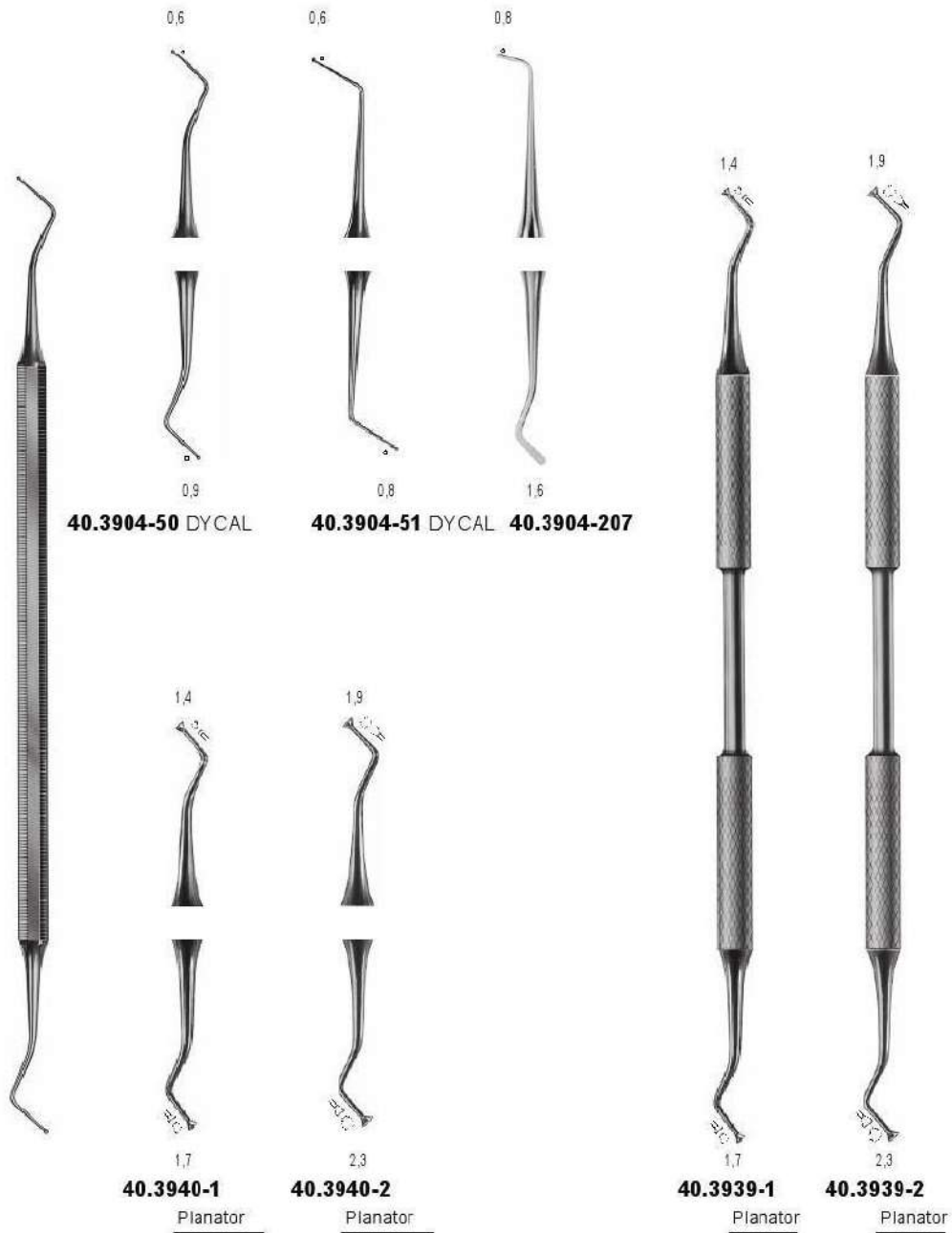



40

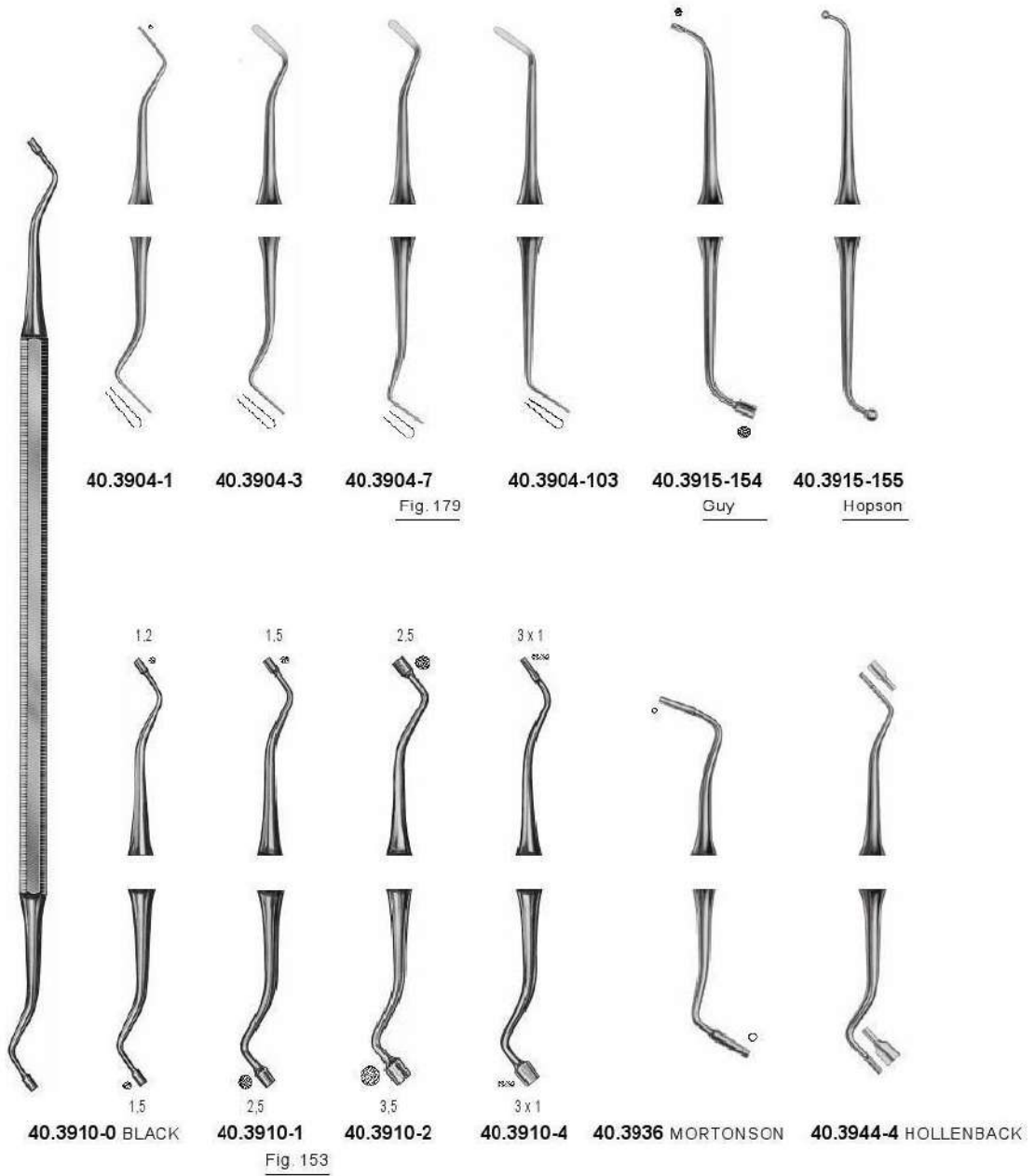



Starre Spatel
 Rigid spatulas
 Spatules rigides
 Espátulas rígidas

40

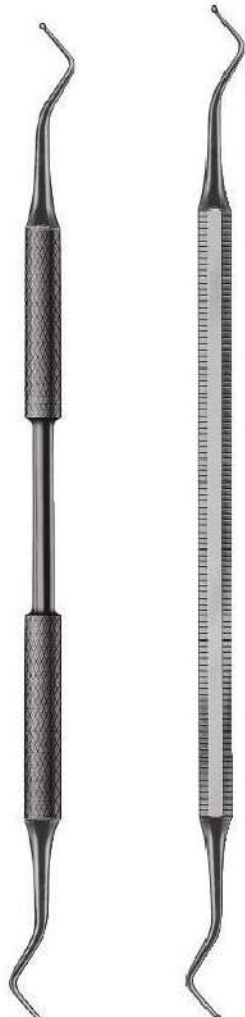

40.3901-ROTONDO
 Rundgriff
 Round handle
 Manche rond
 Mango redondo

40.3902-OCTO
 Achtkantgriff
 Octagonal handle
 Manche octogonal
 Mango octogonal



40.3902-15 **40.3902-16**
Octo Octo
40.3901-15 **40.3901-16**
Rotondo Rotondo

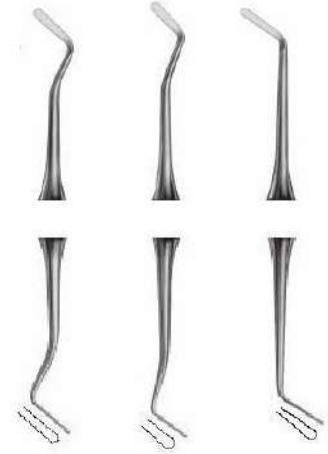

40.3904-3 **40.3904-7** **FIG. 179** **40.3904-103**
Octo Octo Octo

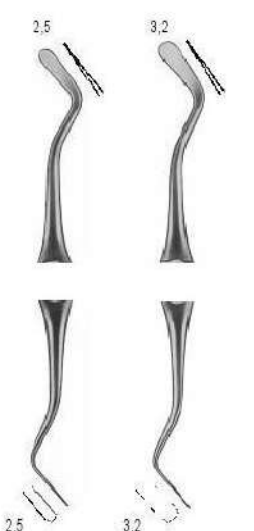

40.3902-13 **40.3902-14**
Octo Octo
40.3901-13 **40.3901-14**
Rotondo Rotondo



40.3907-13 **40.3907-14** **40.4050-4** **FIG. 156**
Octo Octo Octo

Flexible Spatel
 Flexible spatulas
 Spatules flexibles
 Espátulas flexibles



Composite Instrumente
 Composite instruments
 Instruments pour composite
 Instrumentos para composite

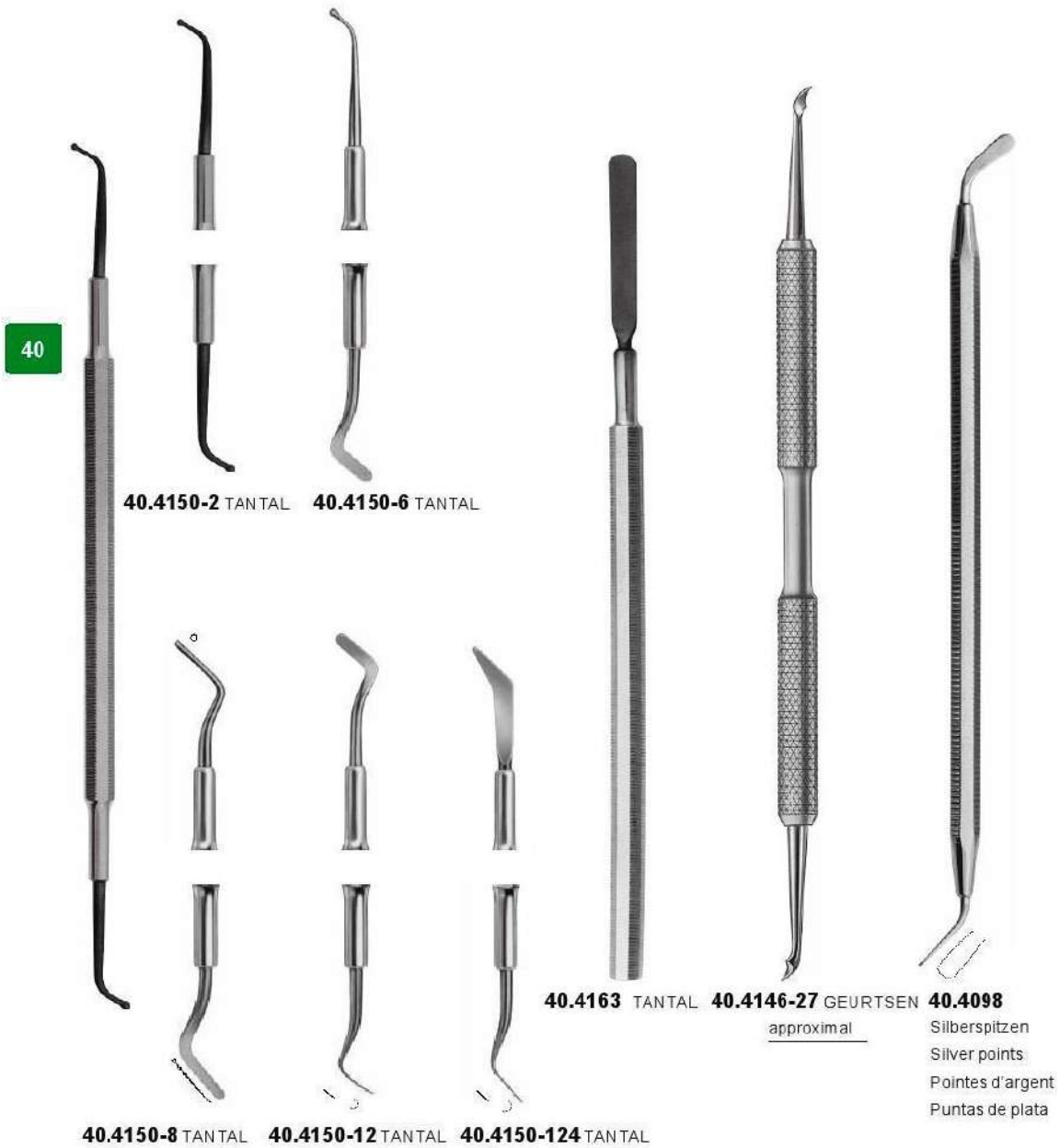

Flexible Spatel
Flexible spatulas
Spatules flexibles
Espátulas flexibles

- ▶ Hochglanzpolierte Arbeitsenden mit TiN-Beschichtung
- ▶ Reduziert Kleben des Composites am Instrument
- ▶ Kein Verfärben der Füllungen

- ▶ Working ends with high mirror polish and TiN-coating
- ▶ Reduces sticking of composite on instrument
- ▶ No discoloration of the composite materials

- ▶ Pointes avec polissage très fin et enduit TiN
- ▶ Réduit l'adhésion du composite sur l'instrument
- ▶ Aucune décoloration des matières composites

- ▶ Puntas con pulimento muy fino y capa TiN
- ▶ Reduzo la adherencia del composite sobre el instrumento
- ▶ Ninguna descoloración de los **materiales composite**

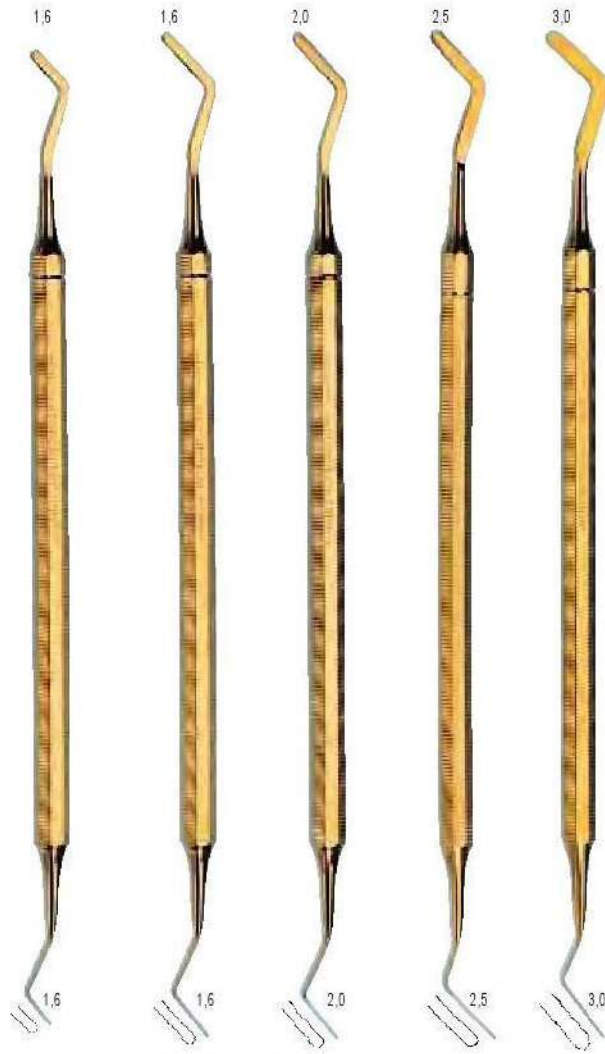

40

40.4086-10 40.4086-0 40.4086-1 40.4086-2 40.4086-3

sehr fein und flexibel
 very fine and flexible
 très fin et flexible
 muy delgado y flexible

Starre Spatel
 Rigid spatulas
 Spatules rigides
 Espátulas rígido

Füllungsinstrumente
 Filling instruments
 Instruments pour obturations
 Instrumentos para obturaciones

Modellierinstrumente
 Carving instruments
 Instruments à modeler
 Instrumentos para modelar

40



40.4086-107

40.4086-113



40.4086-101

40.4086-102



40.4086-122

40.4086-123



40.4086-124

Modellierinstrumente
 Carving instruments
 Instruments à modeler
 Instrumentos para modelar

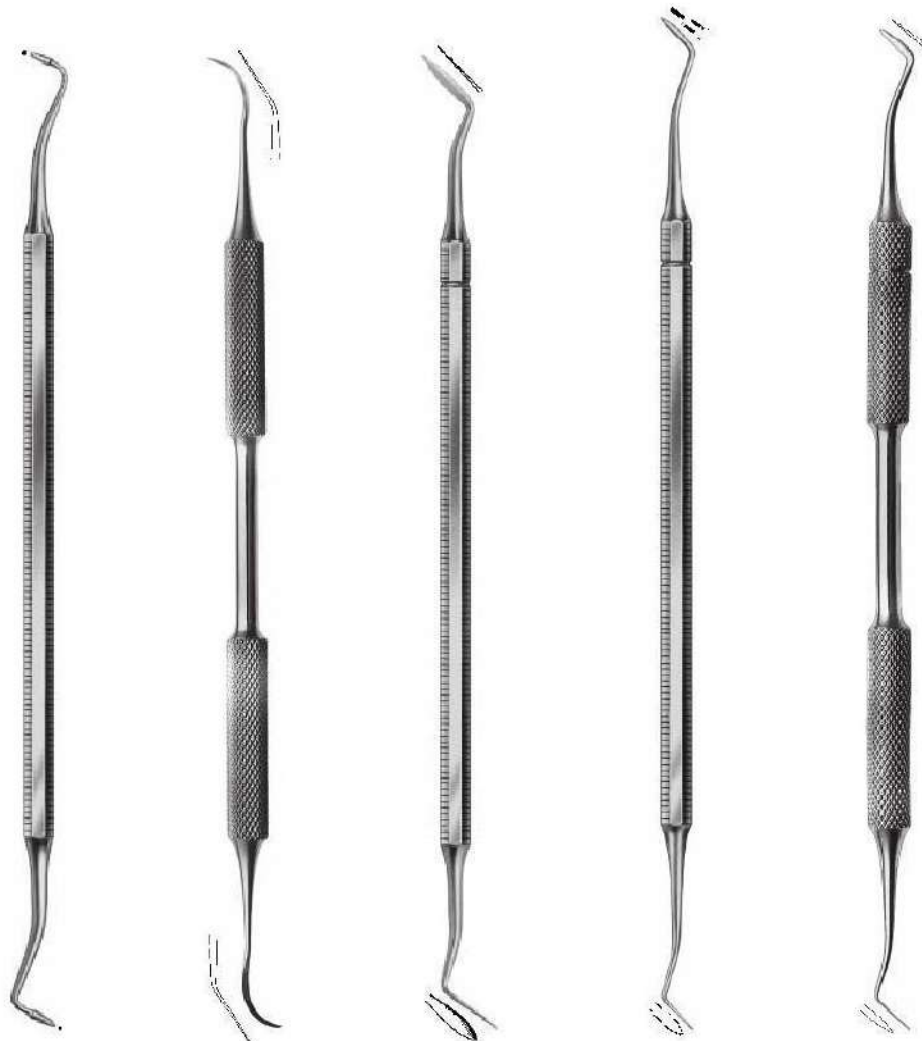

40

40.4123-3

40.4136 WILAND
 occlusal+
 approximal

40.4430 HOLLENBACK
 Fig. 3

40.4430-15 HOLLENBACK
 Fig. 3 S

40.4429-15 HOLLENBACK
 Fig. 3 S

Modellierinstrumente
Carving instruments
Instruments à modeler
Instrumentos para modelar

40

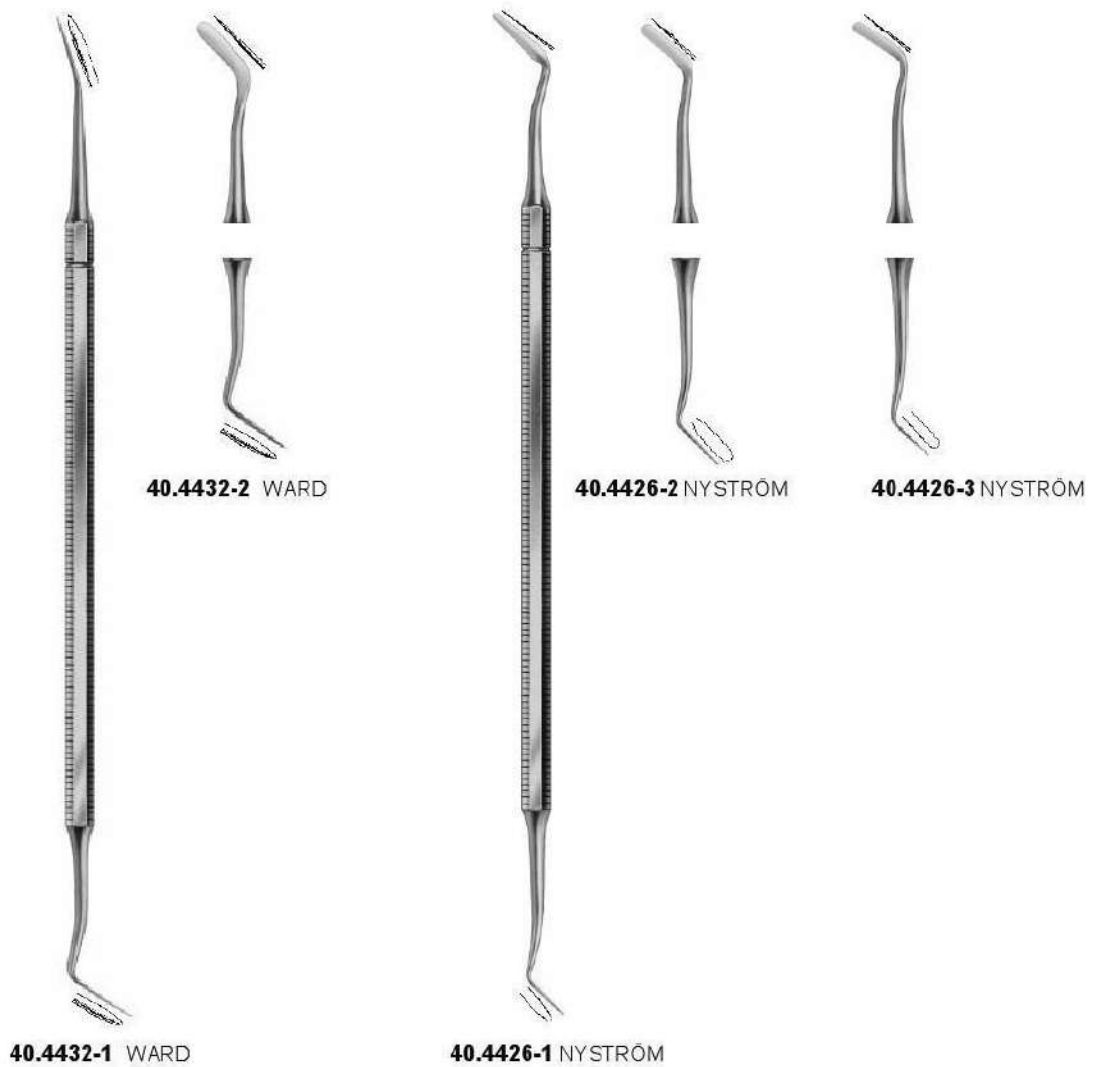

Modellierinstrumente
 Carving instruments
 Instruments à modeler
 Instrumentos para modelar

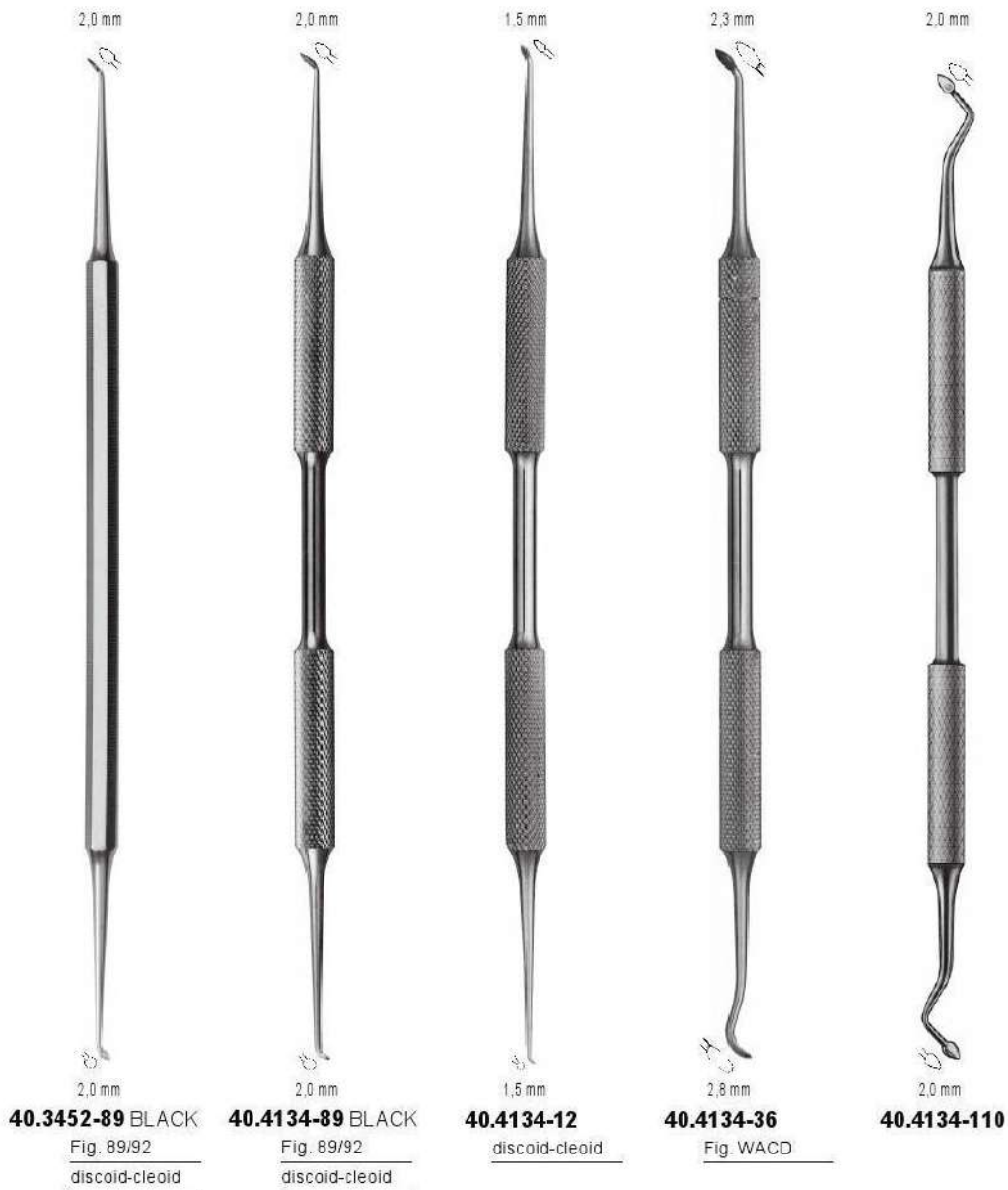

Modellierinstrumente
 Carving instruments
 Instruments à modeler
 Instrumentos para modelar

40



40.4454 FRAHM
45°



40.4127-1 FRAHM
45°



40.4127-10 VIGNON



40.4127-3

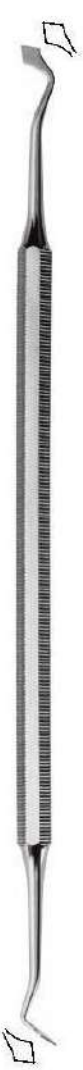

40.4124
Fig. H

Polierer
Burnishers
Brunissoires
Bruñidores



40.4121 WESTCOTT
Fig. 21

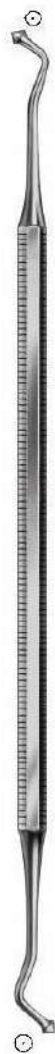

40.4122 WESTCOTT
Fig. 21B



40.4123
Fig. J



40.4126-1 WESTCOTT

40

Polierer
Burnishers
Brunissoires
Bruñidores

40



Zementspatel
 Cement spatulas
 Spatules à ciment
 Espátulas para cemento



40.4325
 flexibel
 flexible
 flexible
 flexible



40.4327



40.4333
 Achat
 Agate
 Agate
 Agata



40.4310

40

40



40.4340
Fig. 8



40.4342-1



40.4342-2



40.4342-3

Kofferdam
 Rubber dam
 Digue de caoutchouc
 Dique de goma

40.3562

Kofferdam-Halter
 Rubber dam holder
 Porte-digues
 Sostenedor

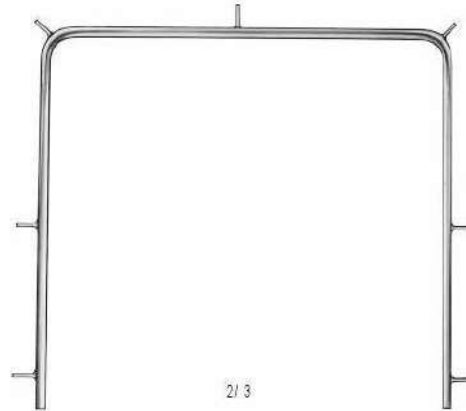

2/3

40



2/3

40.3550 AINSWORTH
 17 cm, Lochzangen
 17 cm, punch forceps
 17 cm, pinces à perforer
 17 cm, perforadores



2/3

40.3552 IVORY
 16 cm, Lochzangen
 16 cm, punch forceps
 16 cm, pinces à perforer
 16 cm, perforadores

Kofferdam
 Rubber dam
 Digue de caoutchouc
 Dique de goma

40



40.3554
 18 cm, Klammerzangen
 18 cm, clamp forceps
 18 cm, pinces porte-crampons
 18 cm, portaclamps



40.3555 STOKES
 17 cm, Klammerzangen
 17 cm, clamp forceps
 17 cm, pinces porte-crampons
 17 cm, portaclamps



40.3557 BREWER
 18 cm, Klammerzangen
 18 cm, clamp forceps
 18 cm, pinces porte-crampons
 18 cm, portaclamps

Wurzelkanalinstrumente
 Root canal instruments
 Instruments radicaux
 Instrumentos radiculares



40.3078
 Wurzelkanal-Sonde
 Explorer for root canal
 Sonde pour le canal
 Sonda para el canal



40.3463-49
 Ø 1,3 mm, Exkavator
 Ø 1,3 mm, Excavator
 Ø 1,3 mm, Excavateur
 Ø 1,3 mm, Excavadore



40.3463-50
 Ø 1,0 mm, Exkavator
 Ø 1,0 mm, Excavator
 Ø 1,0 mm, Excavateur
 Ø 1,0 mm, Excavadore



40.4937 IVORY
 Stifzieher
 Post puller
 Instrument pour enlever les pivots
 Removedor de los pivotes

40

Wurzelkanal-Spreizer
Root canal spreaders
Fouloirs latéraux
Condensadores laterales

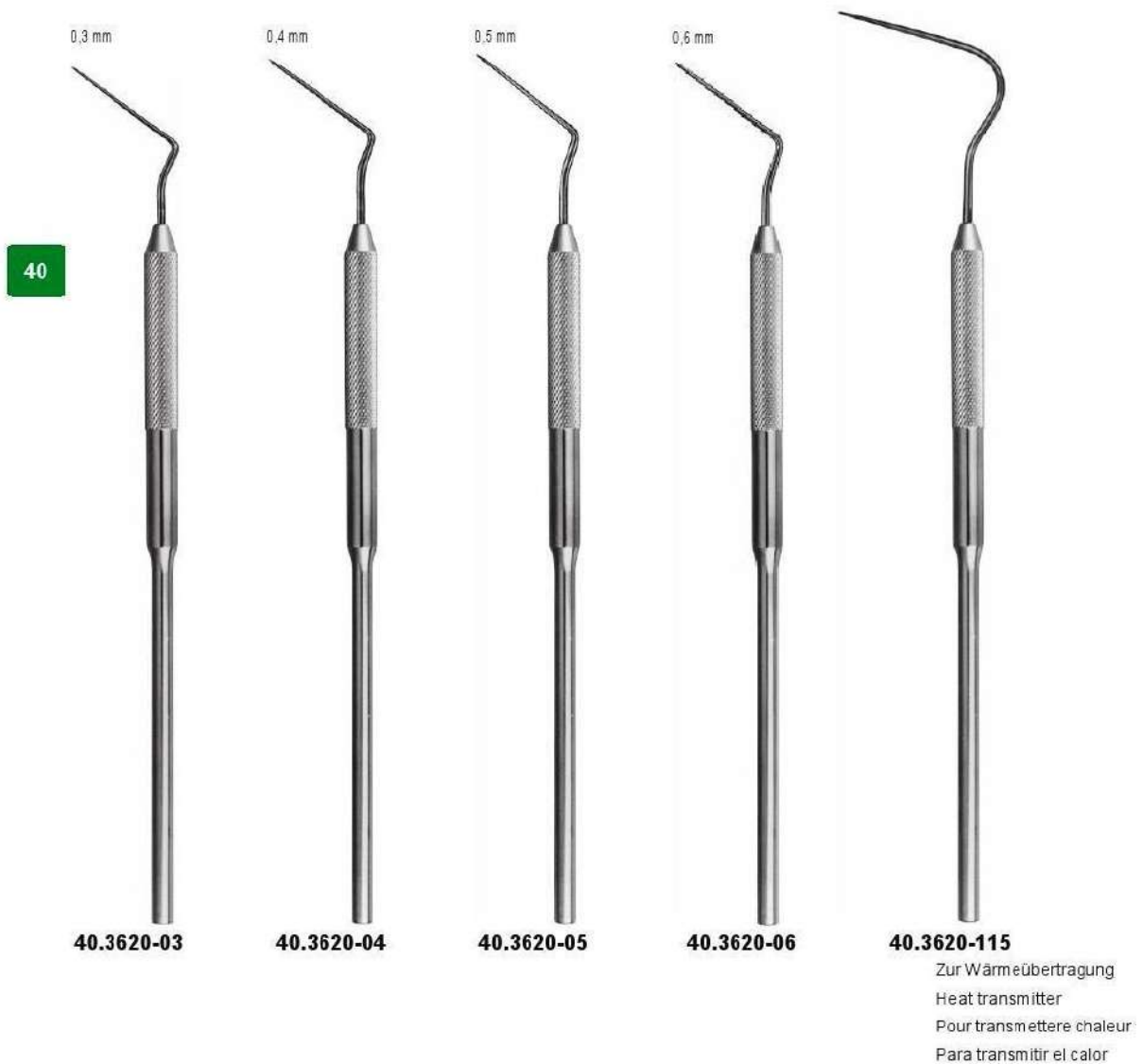

Wurzelkanal-Stopfer
 Root canal pluggers
 Fouloirs à canaux
 Obturadores radiculares

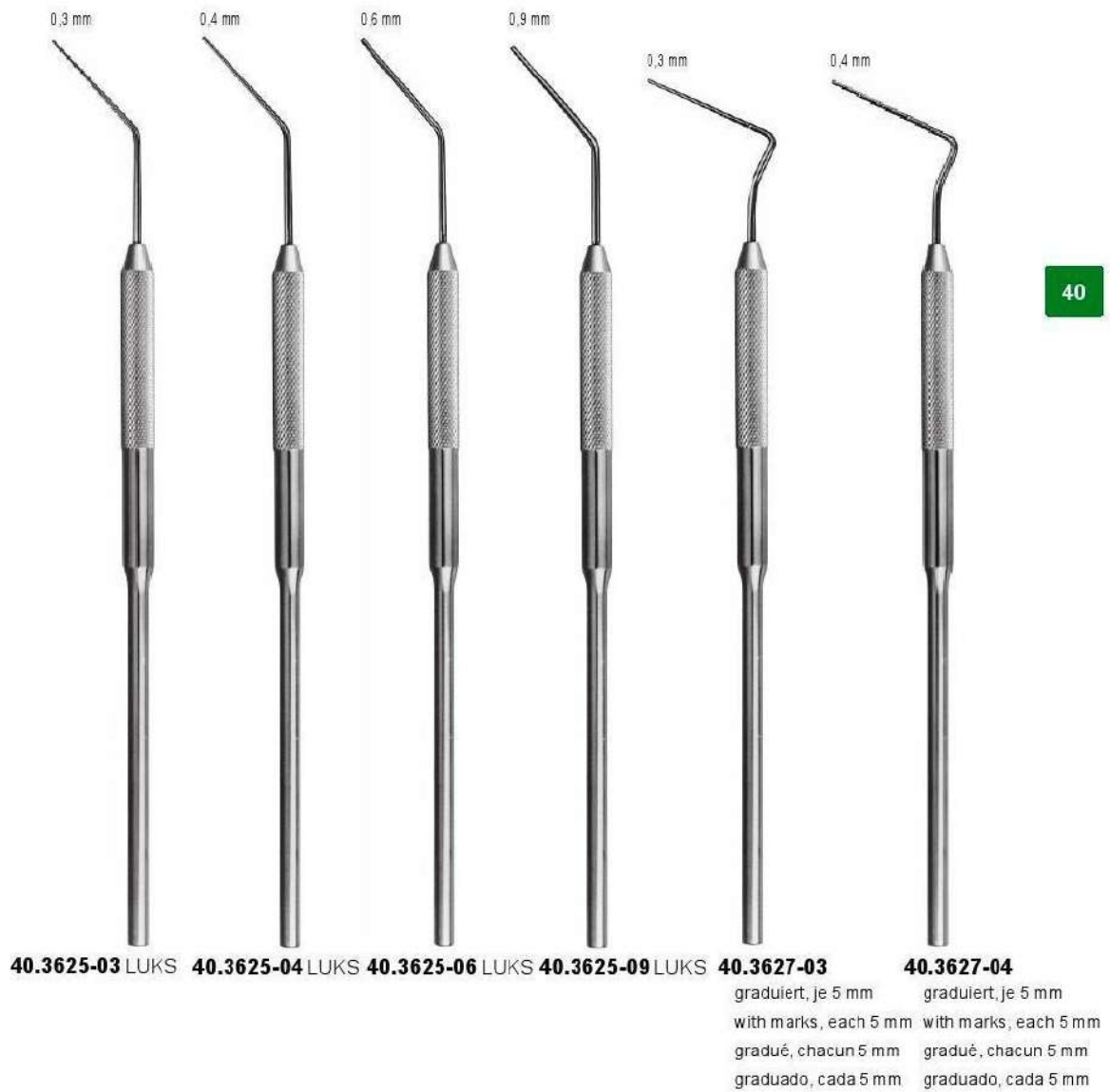

40

Wurzelkanal-Stopper
Root canal pluggers
Fouloirs à canaux
Obturadores radiculares





40.2908

Pinzetten für Silberspitzen
 Silver points forceps
 Pincés pour cônes d'argent
 Pinzas para puntas de plata



40.2988

mit Schloß
 with ratchet
 avec arrêt
 con cremallera



40.3661

für Wurzelstifte
 for root pins
 pour cônes radiculaires
 para punta radicales

40



41

PROTHODONTIA /
ORTHODONTIA

PROTHETIK /
ORTHODONTIE

PROTHÉSE /
ORTHODONTIE

PROTODONCIA /
ORTODONCIA

Modellierinstrumente
 Carving instruments
 Instruments à modeler
 Instrumentos para modelar



Modellierinstrumente
Carving instruments
Instruments à modeler
Instrumentos para modelar

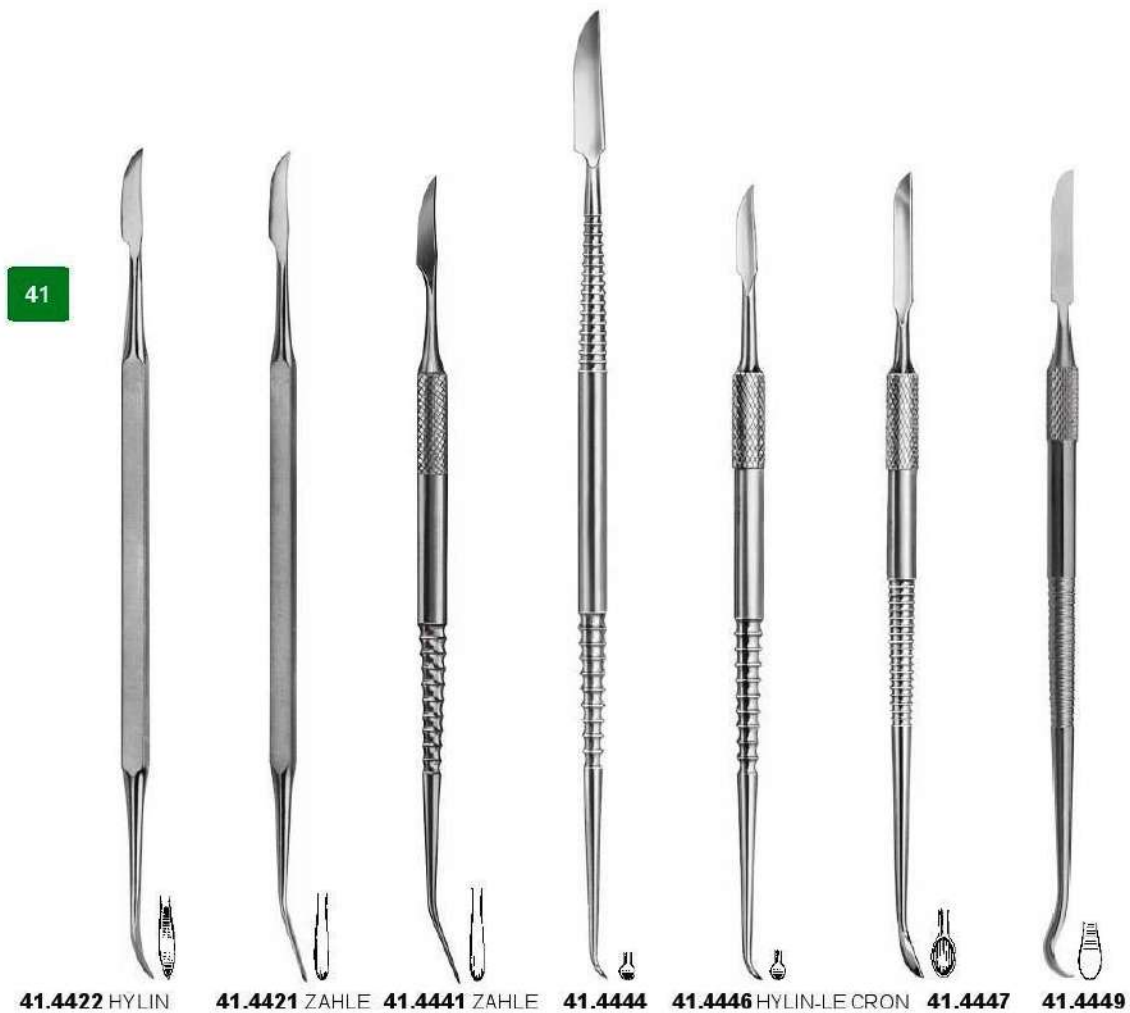

Modellierinstrumente
 Carving instruments
 Instruments à modeler
 Instrumentos para modelar

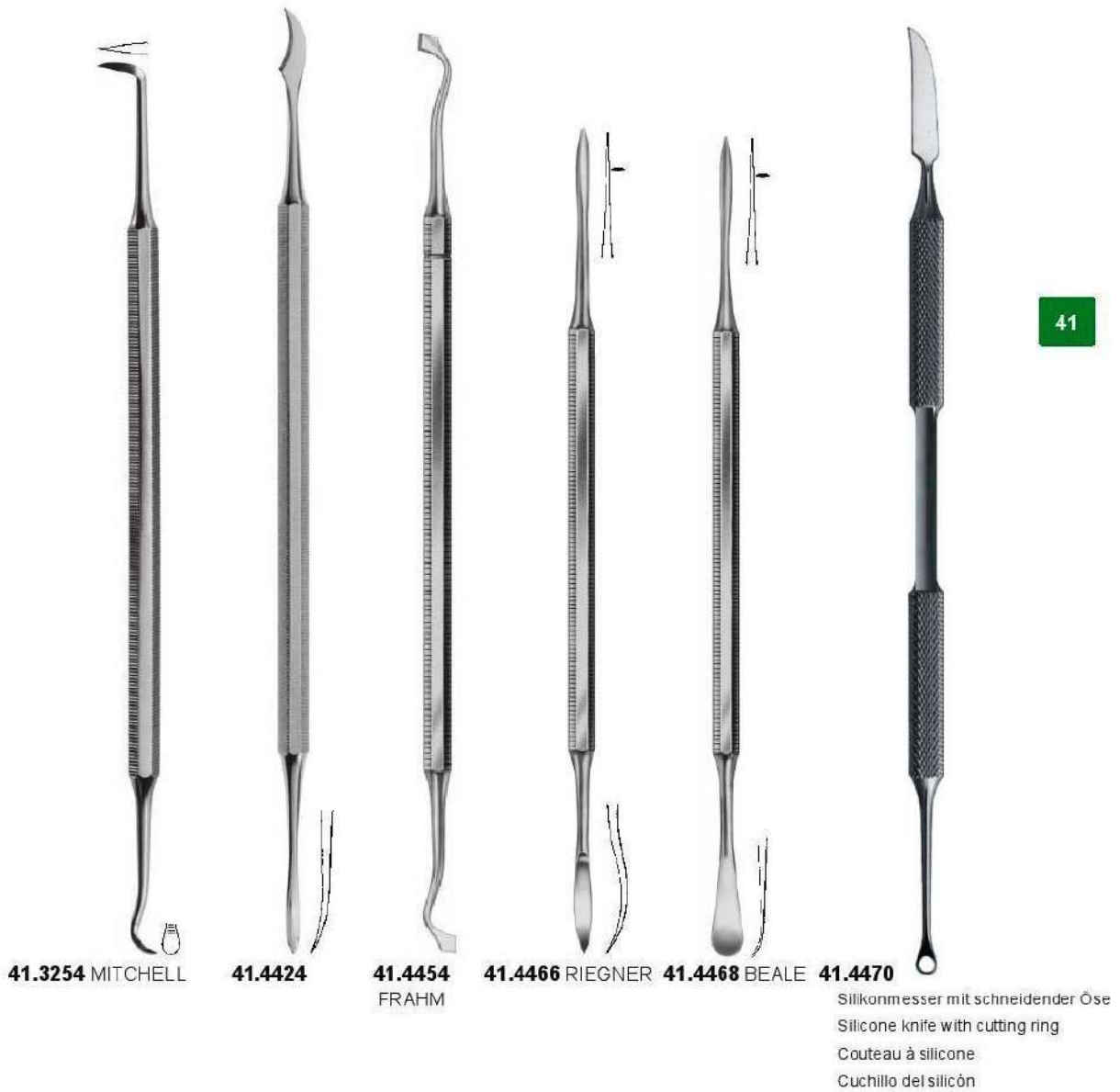

41

Für Aufwachstechnik
 For waxing-on technique
 Pour la technique de moulage à cire
 Para modelar en la técnica cerera

41



41.4480-1 P.K. THOMAS
 Fig. 1



41.4480-2 P.K. THOMAS
 Fig. 2



41.4480-3 P.K. THOMAS
 Fig. 3



41.4480-4 P.K. THOMAS
 Fig. 4



41.4480-5 P.K. THOMAS
 Fig. 5



41.2913 PERRY

41.2631

120 ccm, Spirituslampe
 120 ccm, alcohol lamp
 120 ccm, lampe à alcool
 120 ccm, lámpara de alcoh



41.6070

16 cm, Lötpinzette isoliert
 16 cm, soldering tweezer insulated
 16 cm, pince isolée
 16 cm, pinza aislada para soldar



41.6241

23 cm, Niethammer
 23 cm, riveting mallet
 23 cm, marteau à river
 23 cm, martillo para remachar



41.6245

22 cm, Hornhammer
 22 cm, horn mallet
 22 cm, maillet de corne
 22 cm, mazo de cuerno



41.4501 ERMERT

12 cm



41.4502 ERMERT

14 cm

41

Wachsmesser
 Wax knives
 Couteaux à cire
 Cuchillos para cera

41

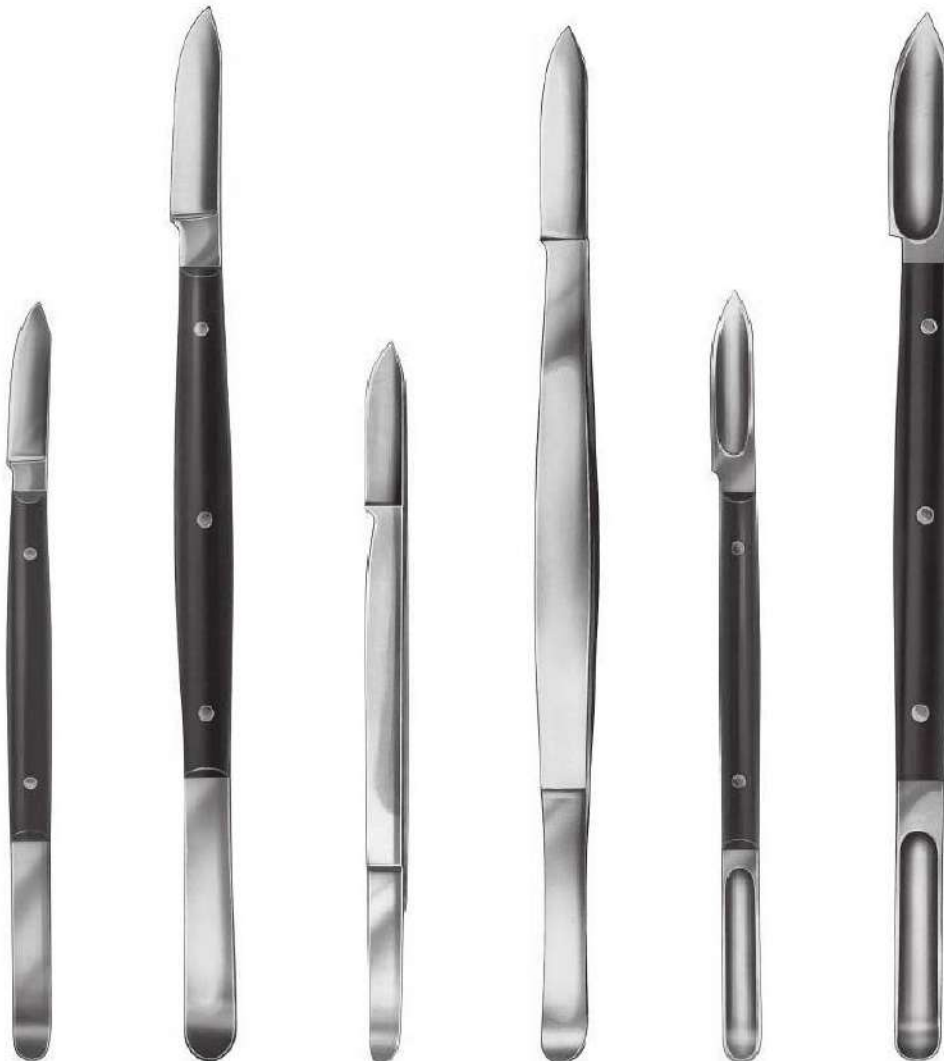

41.4510 FAHNEN-
 STOCK
 13 cm

41.4512 FAHNEN-
 STOCK
 17 cm

41.4516
 12 cm

41.4517
 17 cm

41.4520 LESSMANN
 13 cm

41.4522 LESSMANN
 17 cm

Gipsmesser
 Plaster knives
 Couteaux à plâtre
 Cuchillos para yeso

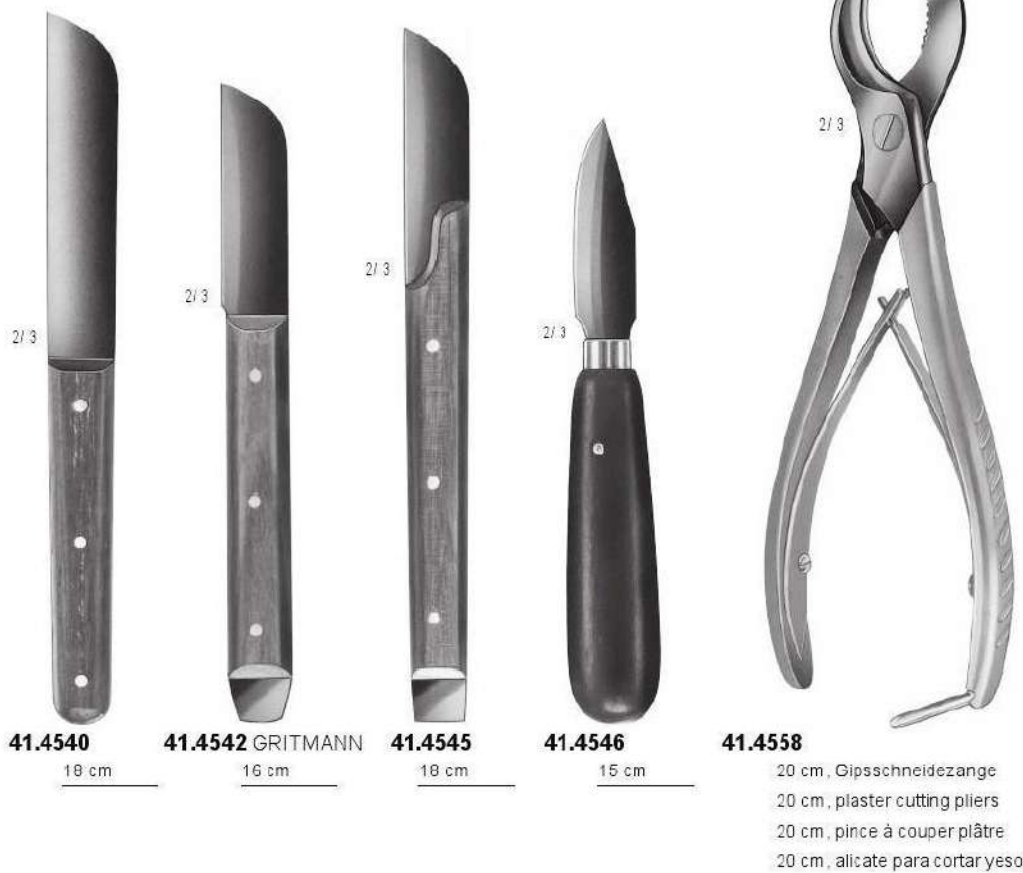

41

Spatel für Abdruckmasse
 Spatulas for impression materials
 Spatules pour matériaux d'empreintes
 Espátulas para materiales de impresión



Kronen- und Blechscheren
 Crown and plate scissors
 Ciseaux à couronnes et tôle
 Tijeras para coronas y planchas

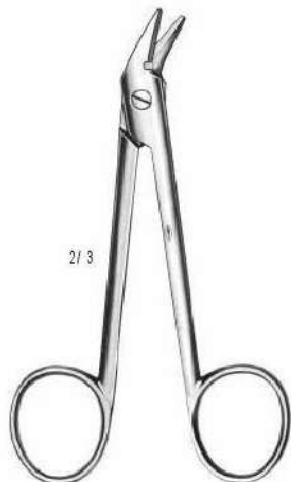

41.4862
 12 cm, gezahnt
 12 cm, saw edge
 12 cm, dentelés
 12 cm, dentadas



41.4869
 10 cm, gebogen
 10 cm, curved
 10 cm, courbes
 10 cm, curvas



41.4865
 10,5 cm, gebogen
 10,5 cm, curved
 10,5 cm, courbes
 10,5 cm, curvas

41.4863 TC GOLD
 12 cm, Hartmetalleinsätze
 12 cm, tungsten carbide insert
 12 cm, pointes en tungstène
 12 cm, puntas de tungsteno

41



41.4821 BEEBEE
 10,5 cm, spitz, gerade
 10,5 cm, sharp, straight
 10,5 cm, pointus, droits
 10,5 cm, agudas, rectas



41.4825 BEEBEE
 spitz, gebogen
 sharp, curved
 pointus, courbes
 agudas, curvas



41.4841
 12 cm, gerade, gezahnt
 12 cm, straight, saw edge
 12 cm, droits, dentelés
 12 cm, rectas, dentadas



41.4845
 gebogen, gezahnt
 curved, saw edge
 courbes, dentelés
 curvas, dentadas

Kupferringabnehmezange
 Copper ring removing pliers
 Pince à enlever les bagues en cuivre
 Pinza para sacar anillos de cobre

Retraktionsfadenstopfer
 Gingival cord packer
 Pour fil retracteur
 Para hilo retractor

41



41.4946 FURRER
 15 cm



41.4880-1
 gezahnt
 saw edge
 dentelés
 dentadas

41.4880-2
 gezahnt
 saw edge
 dentelés
 dentadas

41.4880-3 UNIVERSAL
 45°, gezahnt
 45°, saw edge
 45°, dentelés
 45°, dentadas



41.4890 MILLER
 Artikulationspapierpinzette
 Forceps for articulating paper
 Pince pour papier à articuler
 Pinza para papel de articular



41.4937 IVORY
 Stiftzieher
 Post puller
 Instrument pour enlever les pivots
 Removedor de los pivotes

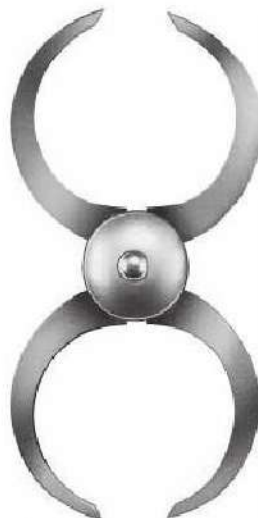

41.4892
 Tasterzirkel
 Caliper
 Compas d'épaisseur
 Calibre



IWANSON

41.4894 IWANSON
 10 cm, Zehntelmaß
 10 cm, decimal caliper
 10 cm, calibre décimal
 10 cm, calibrador decimal

41.4894-1 IWANSON
 10 cm, für Wachs
 10 cm, for wax
 10 cm, pour cire
 10 cm, para cerera

41

Kronenabnehmer
 Crown removers
 Instruments à détacher les couronnes
 Instrumentos para quitar coronas

41



41.4920 TREYMANN



41.4924 MORELL

mit Ansätzen Nr. 41.4924-1 + 41.4924-2
 with tips No. 41.4924-1 + 41.4924-2
 avec pointes No. 41.4924-1 + 41.4924-2
 con puntas No. 41.4924-1 + 41.4924-2

41.4924-10 MORELL

komplett mit 3 Ansätzen
 complete with 3 tips
 complet avec 3 pointes
 completo con 3 puntas



41.4925 MORELL

mit Ansätzen Nr. 41.4924-1 + 41.4924-2
 with tips No. 41.4924-1 + 41.4924-2
 avec pointes No. 41.4924-1 + 41.4924-2
 con puntas No. 41.4924-1 + 41.4924-2

41.4925-10 MORELL

komplett mit 3 Ansätzen
 complete with 3 tips
 complet avec 3 pointes
 completo con 3 puntas

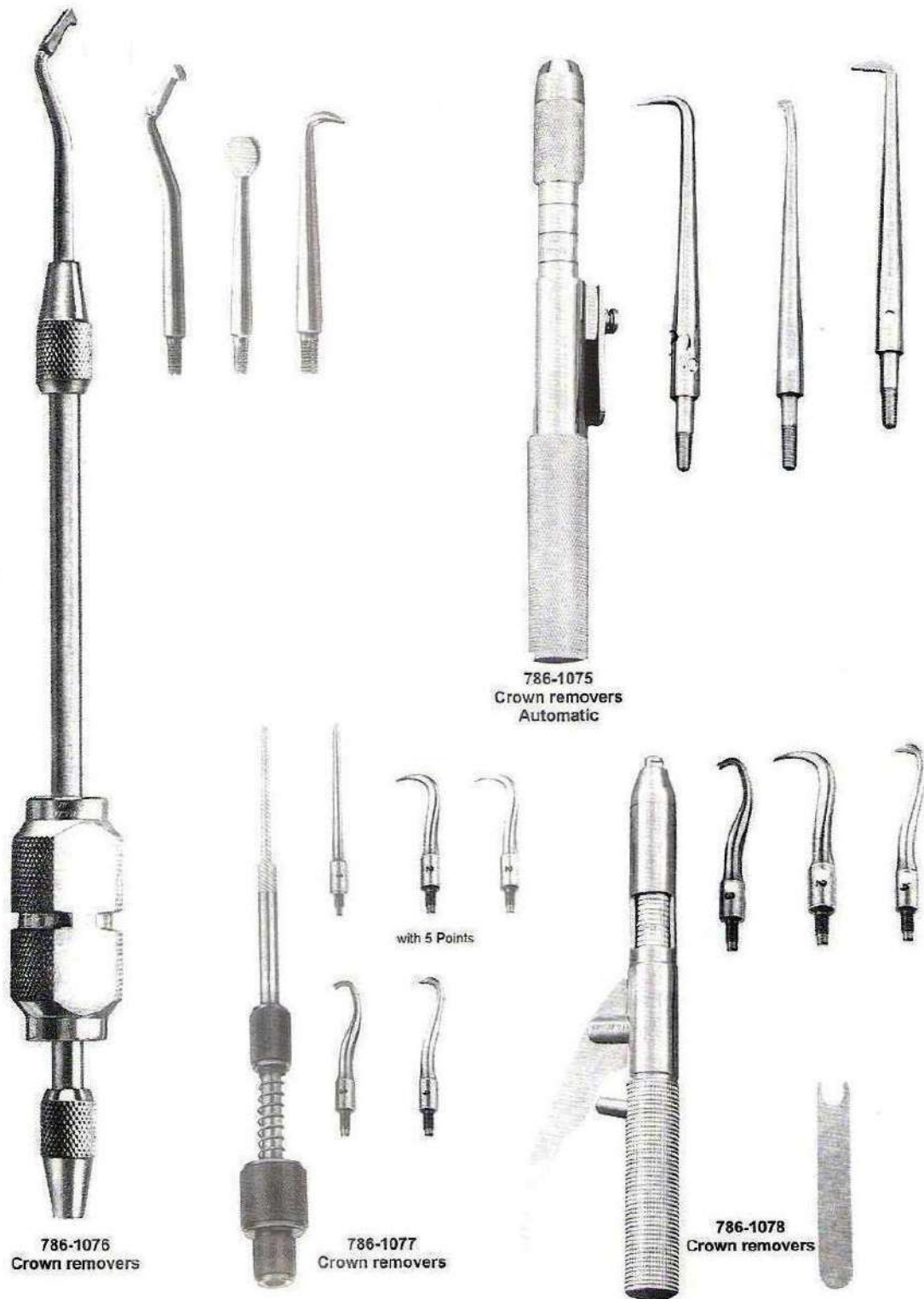

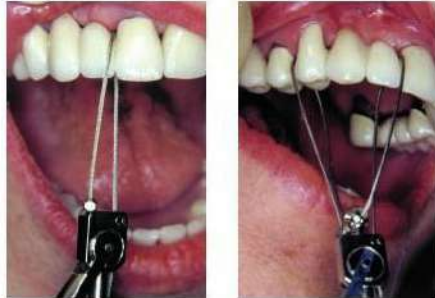

Kronenabnehmer Lift-ex
 Crown removers Lift-ex
 Instruments à détacher les couronnes Lift-ex
 Instrumentos para quitar coronas Lift-ex



41.4924-21 SINGLE-LOOP TIP
 Set mit 1 Single-Loop Tip, Adapter und Schlüssel
 Set with 1 Single-Loop Tip, adapter and key
 Ensemble avec 1 Single-Loop Tip, adaptateur et clé
 Sistema con 1 Single-Loop Tip, adaptador y llave

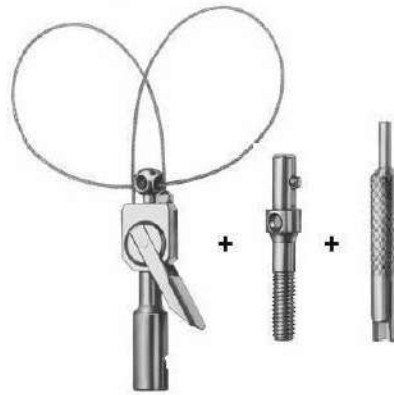

41.4924-22 DOUBLE-LOOP TIP
 Set mit 1 Single-Loop Tip, Adapter und Schlüssel
 Set with 1 Single-Loop Tip, adapter and key
 Ensemble avec 1 Single-Loop Tip, adaptateur et clé
 Sistema con 1 Single-Loop Tip, adaptador y llave

41



41.4924-26 Adapter
 Adapter
 Adaptateur
 Adaptador

41.4924-25 Schlüssel
 Key
 Clé
 Llave



41.4924-31
 Ersatzschleife f. Single-Loop Tip
 Spare loop for Single-Loop Tip
 Boucle disponible pour Single-Loop Tip
 Lazo de repuesto por Single-Loop Tip



41.4924-32
 Ersatzschleife f. Double-Loop Tip
 Spare loop for Double-Loop Tip
 Boucle disponible pour Double-Loop Tip
 Lazo de repuesto por Double-Loop Tip

Kronenabnehmer
Crown removers
Instruments à détacher les couronnes
Instrumentos para quitar coronas



Kronenabnehmezangen
Crown trial forceps
Pinces pour couronnes en ceramique
Alicates para coronas ceramicas

41.4940-100

- 1 Paar Kunststoffbacken
- 1 pair of inserts
- 1 paire de protecteurs
- 1 pareja de capas



41.4940-17

☞ 13 - 18, 23 - 28



41.4940-22

☞ 33 - 38, 43 - 48



41.4940-217

☞ 3 - 8

- Amerikanische Form
- American pattern
- Modèle américain
- Modelo americano

41

Teleskopkronenzangen
 Pliers for telescope crowns
 Pincès pour couronnes telescopes
 Alicates para coronas telescópicas



41.4947 BÖHM
 15 cm



41.4947-2 BÖHM
 13 cm, fein
 13 cm, fine
 13 cm, gracile
 13 cm, grácil



41.4947-5
 13.5 cm, diamantierte Spitzen
 13.5 cm, diamond tips
 13.5 cm, pointes diamantées
 13.5 cm, puntas diamantadas

41.4947-6

- 1 Paar Ersatzspitzen
- 1 pair of replacement tips
- 1 paire de pointes de rechange
- 1 pareja de puntas de recambio



Stainless Steel Impression Trays
Made of 18/8 Stainless Steel

Solid Partial Set of 10
786-001wa



All the above impression trays are available in these 5 sizes

		UPPER					LOWER						
		U1	U2	U3	U4	U5	L1	L2	L3	L4	L5		
A	B	A	62	60	53	54	52	A	63	61	57	60	53
		B	83	75	73	69	68	B	82	81	78	74	71

All Dimension are in mm

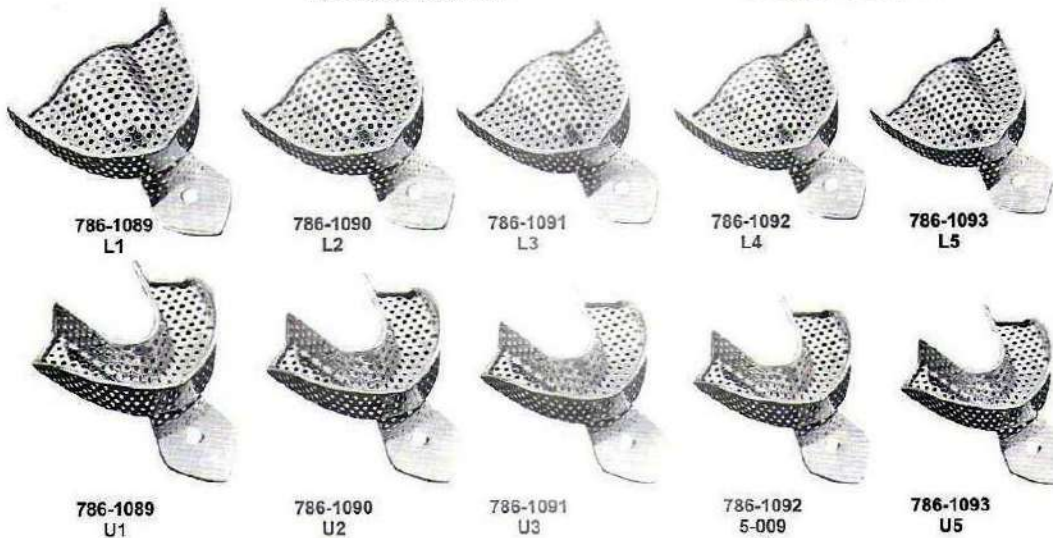

Perforated Partial Set of 10
786-010wa

Stainless Steel Impression Trays
Made of 18/8 Stainless Steel

Solid Full Denture Set of 8
786-011wa

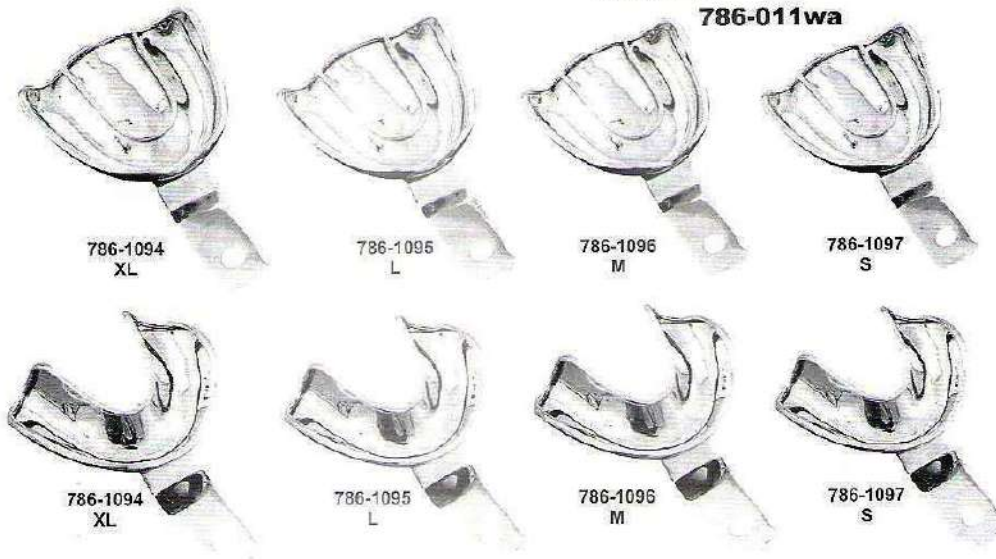

All the above impression trays are available in these 4 sizes

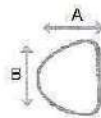

UPPER

	XL	L	M	S
A	70	67	64	60
B	79	76	70	73

All Dimension are in mm

LOWER

	XL	L	M	S
A	64	64	60	57
B	86	70	73	70

All Dimension are in mm

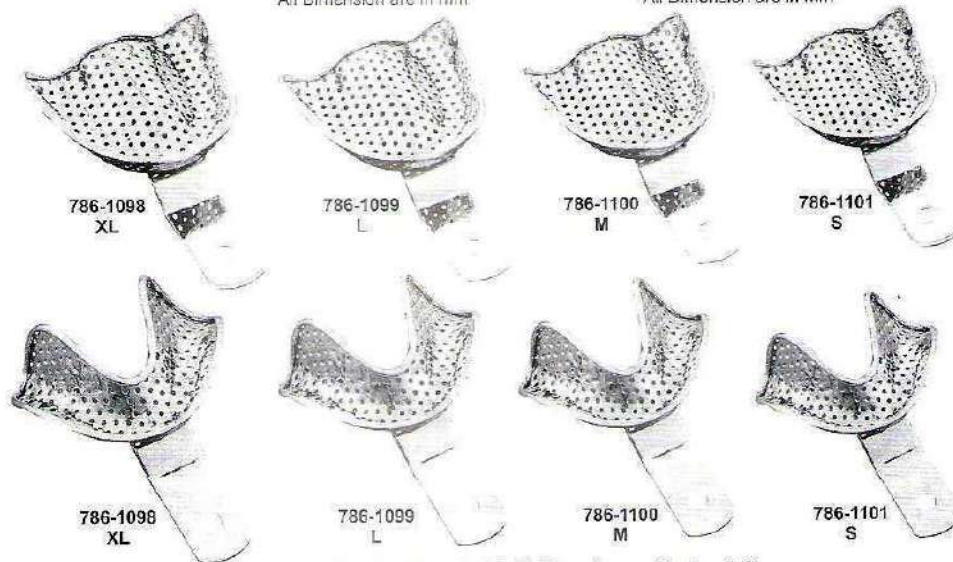
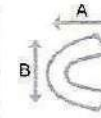

Perforated Full Denture Set of 8
786-018wa

Stainless Steel Impression Trays
Made of 18/8 Stainless Steel

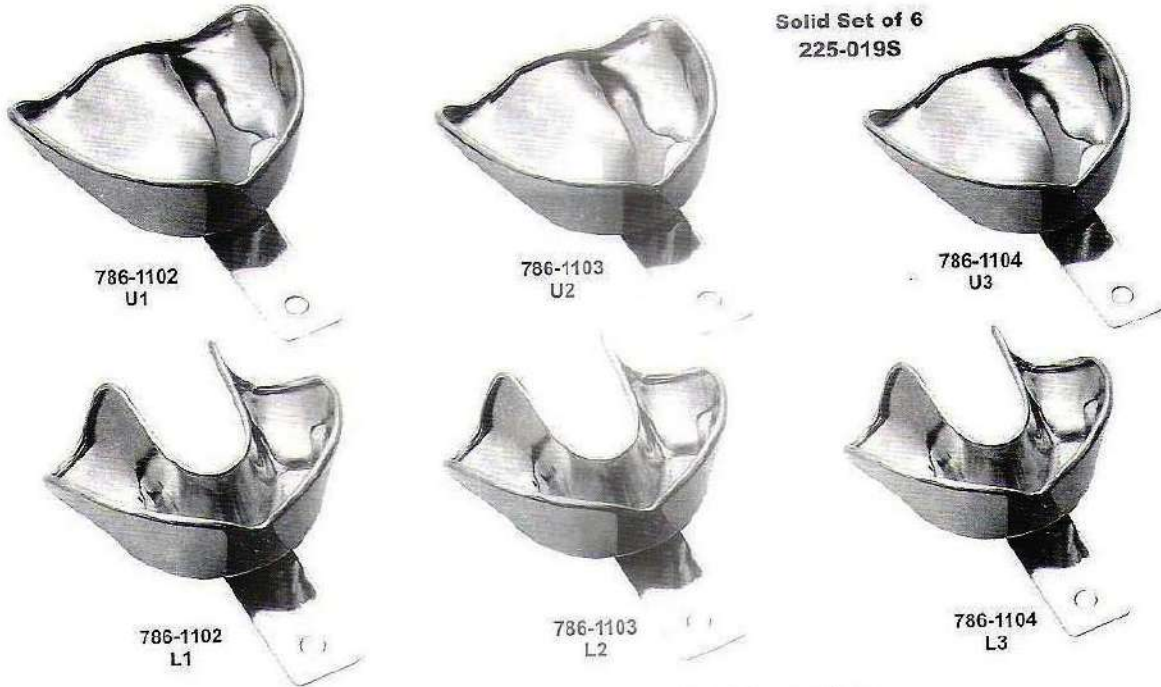

Solid Set of 6
225-019S

All the above impression trays are available in these 3 sizes

UPPER	U1	U2	U3
	A	67	64
B	81	71	70

All Dimension are in mm

LOWER	L1	L2	L3
	A	60	57
B	81	79	76

All Dimension are in mm



Perforated Set of 6
225-024S

**Stainless Steel Impression Trays
 Made of 18/8 Stainless Steel**

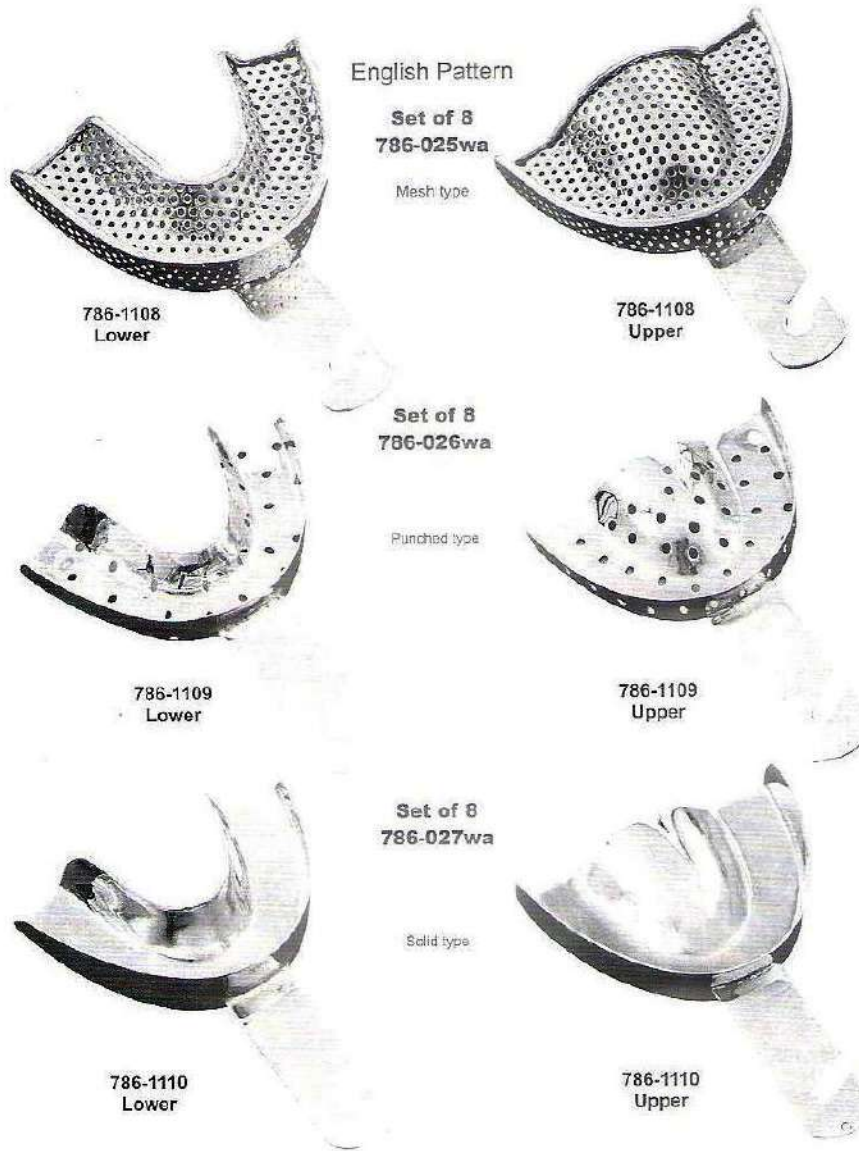

All the above impression trays are available in these 4 sizes

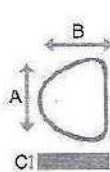

UPPER	Size	A	B	C
	0	67	50	12
	1	72	51	13
	2	78	55	15
	3	80	58	15

All Dimension are in mm



LOWER	Size	A	B	C
	0	70	50	14
	1	77	51	15
	2	79	55	15
	3	80	60	17

All Dimension are in mm

Stainless Steel Impression Trays
Made of 18/8 Stainless Steel

Solid Full Denture Set of 8
786-028wa



All the above impression trays are available in these 4 sizes

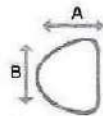

UPPER	XL	L	M	S
	A	70	67	64
B	79	76	70	73

All Dimension are in mm

LOWER	XL	L	M	S
	A	64	64	60
B	86	70	73	70

All Dimension are in mm

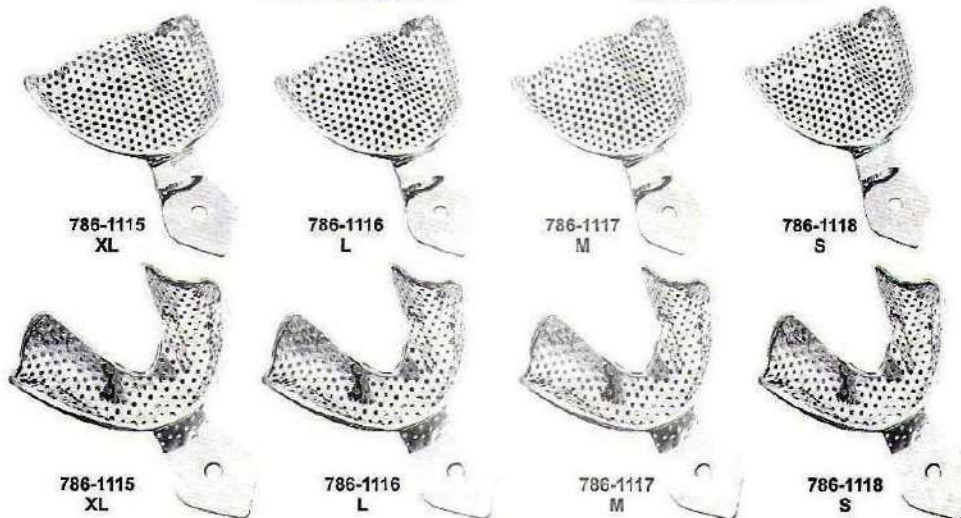
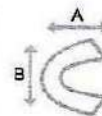

Perforated Full Denture Set of 8
786-035wa

**Stainless Steel Impression Trays
 Made of 18/8 Stainless Steel**

English Pattern



Solid Full Denture Set of 8
786-036wa



Upper Sizes 0,1,2,3,
Depth of the tray 15,9 mm
Height of palate 12,5 mm

Lower Sizes 0,1,2,3,
Depth of the tray 12,9 mm



Perforated Full Denture Set of 8
786-043wa

**Stainless Steel Impression Trays
 Made of 18/8 Stainless Steel**

Impression trays for crown & bridge work

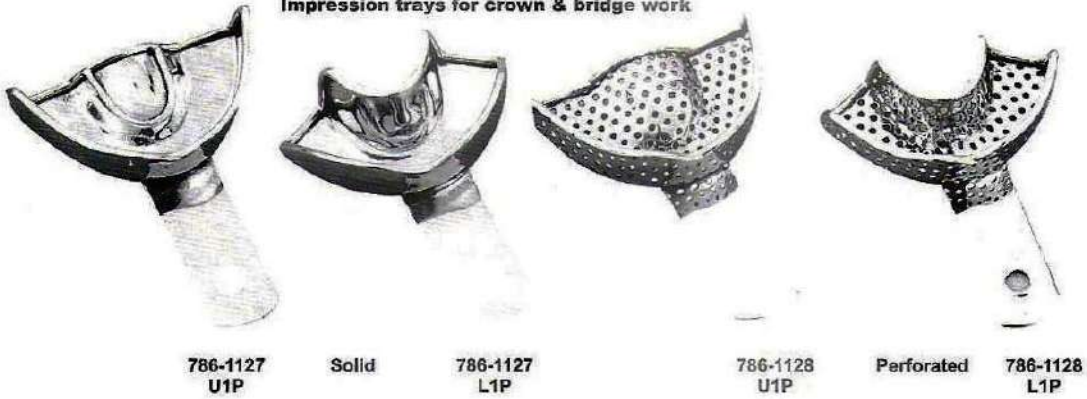

Available in 4 Sizes
 1..... 44 mm
 2..... 55 mm
 3..... 60 mm
 4..... 65 mm

Also available in Solid pattern

- ▶ **Längere Haltbarkeit** durch extraharten Spezialstahl
- ▶ **Exakteres Arbeiten** durch präzise Formgebung
- ▶ **Longer life** through very hard high-grade steel
- ▶ **Better work results** through precise form of pliers
- ▶ **Solidité supérieure** par acier inoxydable extra-dur
- ▶ **Travail plus exact** par un précis façonnage des pinces
- ▶ **Solidez superior** por acero inoxidable extra-duro
- ▶ **Trabajo más exacto** por un modelado preciso de las alicates



41

41.5012

- 13 cm, geriett
- 13 cm, serrated
- 13 cm, striée
- 13 cm, estriado

41.5014-1

- 13 cm, geriett
- 13 cm, serrated
- 13 cm, striée
- 13 cm, estriado

Flachzangen
 Flat nose pliers
 Pinces plates
 Alicates de picos chatos

41



41.5024

13 cm, gerieft
 13 cm, serrated
 13 cm, striée
 13 cm, estriado



41.5023

13 cm, glatt
 13 cm, smooth
 13 cm, lisse
 13 cm, liso



41.5402 GOSLEE

13 cm, glatt-gerieft, Fig. 136
 13 cm, smooth-serrated, Fig. 136
 13 cm, lisse-striée, Fig. 136
 13 cm, liso-estriado, Fig. 136

Flachzangen
 Flat nose pliers
 Pinces plates
 Alicates de picos chatos



41

41.5022

12,5 cm, gerieft
 12,5 cm, serrated
 12,5 cm, striée
 12,5 cm, estriado

41.5026

14 cm, gerieft
 14 cm, serrated
 14 cm, striée
 14 cm, estriado

41.5351 FREVERT

12 cm, gerieft
 12 cm, serrated
 12 cm, striée
 12 cm, estriado

Drahtbiegezaugen
Wire bending pliers
Pinces à courber les fils
Alicates para doblar alambre



41.5153 ADAMS
 Fig. 64, 14,5 cm

41.5153F CARBIDE COATING

Mit Hartmetall beschichtet
 With extra-hard coating
 Avec enduit extra-dur
 Con capa extra-dura



41.5155 TC GOLD

mit extra-harten Einsätzen
 with extra-hard inserts
 avec mors extra-durs
 con filos extra-duros



41.5152 ADAMS
 12 cm

41.5152F CARBIDE COATING

Mit Hartmetall beschichtet
 With extra-hard coating
 Avec enduit extra-dur
 Con capa extra-dura



41.5154 TC GOLD

mit extra-harten Einsätzen
 with extra-hard inserts
 avec mors extra-durs
 con filos extra-duros



41.5182 ANGLE
 12 cm, Bogenbiegezaug
 12 cm, Arch forming pliers
 12 cm, pince à courber les arcs
 12 cm, alicata para doblar arcos

Drahtbiegezaugen
 Wire bending pliers
 Pinces à courber les fils
 Alicates para doblar alambre

41



Drantbiegeezangen

Wire bending pliers

Pinces à courber les fils

Alicates para doblar alambre



41.5179 JARABAK
13 cm

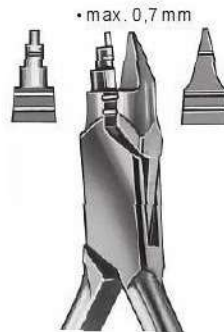

41.5178 YOUNG
14 cm, Fig. 74

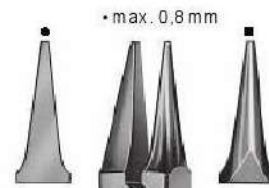

41.5169
16 cm, Fig. 65

41



41.5167 LIGHT-WIRE
12 cm



41.5168
14 cm

41.5169-20 TC GOLD
 mit extra-harten Einsätzen
 with extra-hard inserts
 avec mors extra-durs
 con filis extra-duros



Drahtbiegezaugen
 Wire bending pliers
 Pinces à courber les fils
 Alicates para doblar alambre

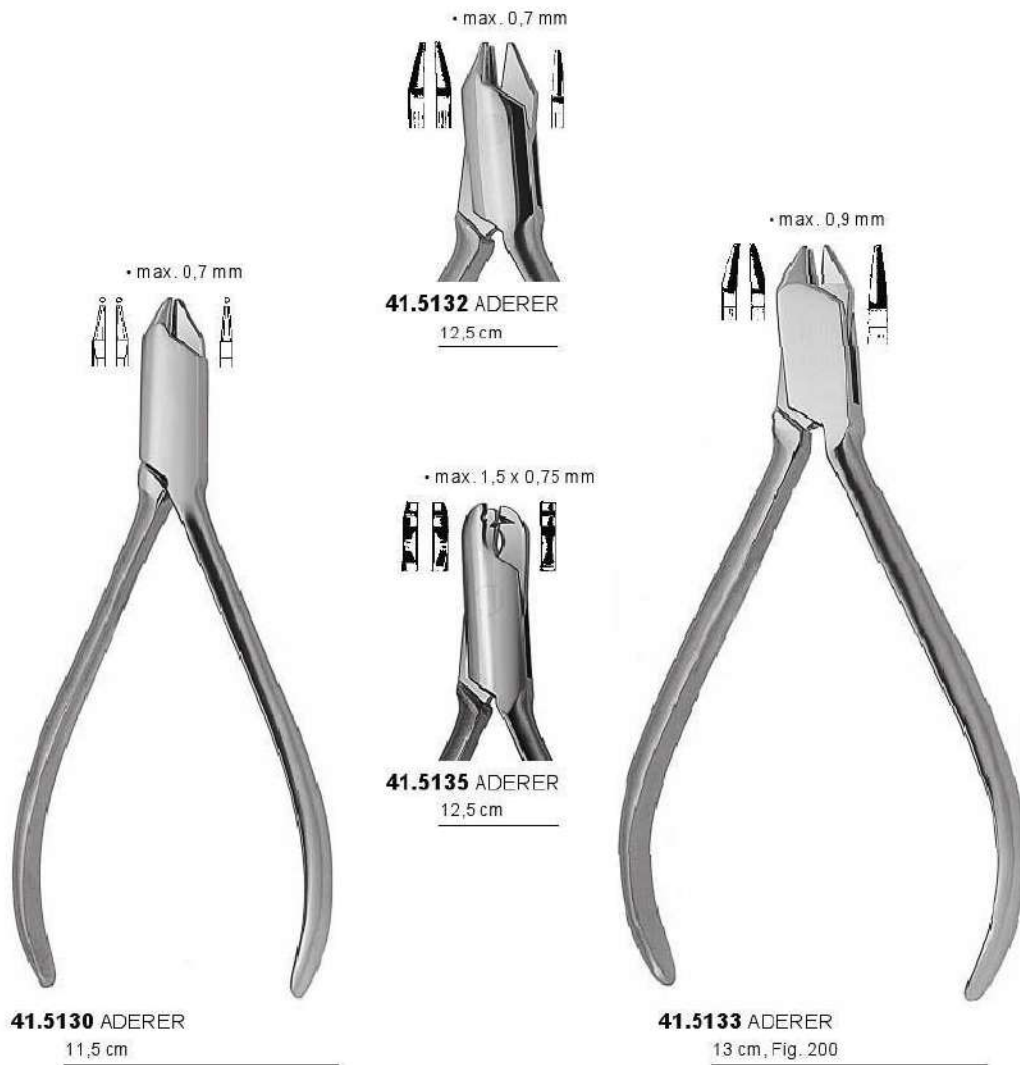

41

Drahtbiegezangen
 Wire bending pliers
 Pinces à courber les fils
 Alicates para doblar alambre

41



• max. 0,7 mm

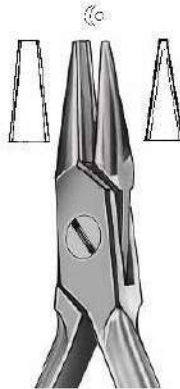

41.5142

13,5 cm

Drahtbiegeezangen

Wire bending pliers

Pinces à courber les fils

Alicates para doblar alambre

⊕ **41.5125 MC KELLOPS**

⊖ **41.5126 MC KELLOPS**

• max. 1,5 mm



41

• max. 0,5 mm

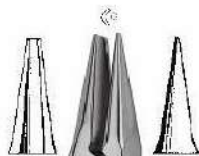

41.5141

13 cm

• max. 0,7 mm



41.5143

13,5 cm

• max. 0,7 mm



41.5144 SCHWARZ

13,5 cm

MC KELLOPS

17 cm, Biegelbiegeezangen

17 cm, bar bending pliers

17 cm, pinces à plier les barres

17 cm, alicates para doblar barras

Klammerbiegeezangen

Clasp bending pliers

Pinces à courber les crochets

Alicates para doblar ganchos



41.5188

13,5 cm, für Adams-Klammern
 13,5 cm, for Adams clasps
 13,5 cm, pour crochets de Adams
 13,5 cm, para ganchos de Adams



41.5190

11,5 cm, Pfeilformzange
 11,5 cm, arrow head clasp forming plier
 11,5 cm, pince à former les flèches
 11,5 cm, alicata para formar las flechas



41.5192

11,5 cm, Pfeilknickzange
 11,5 cm, arrow head clasp bending plier
 11,5 cm, pince à plier les flèches
 11,5 cm, alicata para doblar las flechas



41.5191

13 cm, kombiniert
 13 cm, combined
 13 cm, combinées
 13 cm, combinado

Universalzangen
 Universal pliers
 Pinces universelles
 Alicates universales

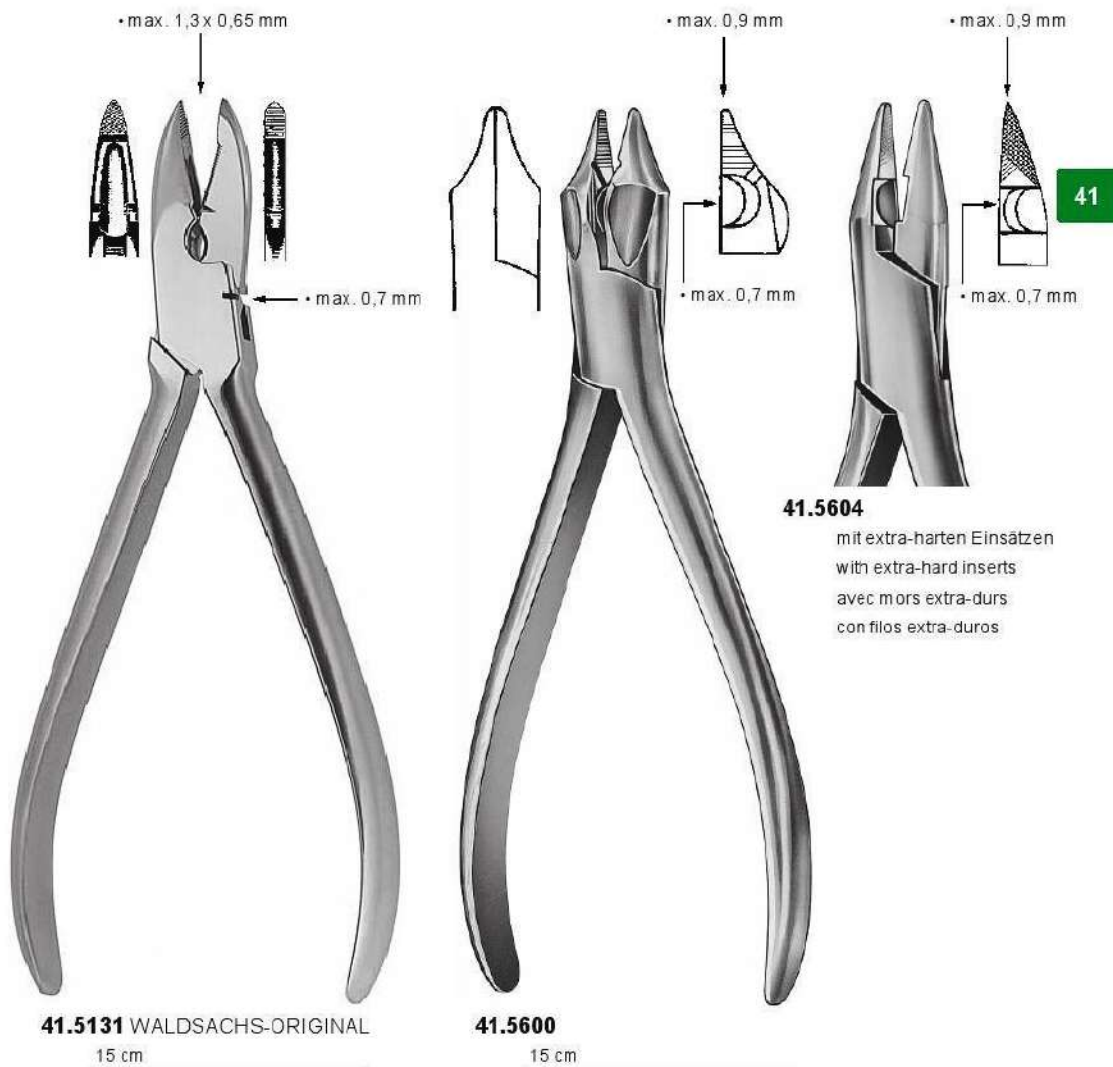

Drahtschneidezangen
Wire cutters
Pinces coupantes
Alicates para cortar alambre

TC GOLD rosttfrei, sterilisierbar, mit extra-harten Einsätzen
 stainless, sterilisable, with extra-hard inserts
 inoxydable, sterilisable, avec mors extra-durs
 inoxidable, esterilizable, con filos extra-duros



41

41.5255
 14 cm, verchromt, nicht sterilisierbar
 14 cm, chrome-plated, not sterilisable
 14 cm, chromée, non-sterilisable
 14 cm, cromada, no esterilizable

41.5268
 Werkzeugqualität, nicht sterilisierbar
 Tool quality, not to be sterilized
 Qualité d'outil, non-sterilisable
 Calidad de herramienta, no esterilizable

41.5256 TC GOLD
 14 cm

41.5254 TC GOLD
 12 cm

41.5260 TC GOLD
 18 cm

Drahtspannzange
 For wire ligatures
 Pour ligatures de fil
 Para ligaduras de alambre



41.2024 TC GOLD
 15 cm, Hartmetalleinsätze
 15 cm, Tungsten carbide inserts
 15 cm, Pointes en tungstène
 15 cm, Puntas de tungsteno



MATHIEU
 14 cm

41.2053



41.2057 TC GOLD

Hartmetalleinsätze
 Tungsten carbide inserts
 Pointes en tungstène
 Puntas de tungsteno

41

Ligaturinstrumente
Ligature instruments
Instruments à ligature
Instrumentos para ligaduras



Bandinstrumente
 Band instruments
 Instruments à bagues
 Instrumentos para bandas



41.4948 OLIVER-JONES
 15 cm, Bandabnehmezange
 15 cm, band removing pliers
 15 cm, pince à enlever les bagues
 15 cm, alicate para sacar bandas



41.4950
 15 cm, Bandaufsetzer
 15 cm, band setter
 15 cm, instrument à adapter
 15 cm, adaptor de bandas



41.4952 MERSHON
 15 cm, Bandandrücker
 15 cm, band pushers
 15 cm, instrument à pousser
 15 cm, empujadores de bandas

41

Konturzangen
Contouring pliers
Pincès à bouteroller
Alicates para contornear

41



41.5351 FREVERT
12 cm

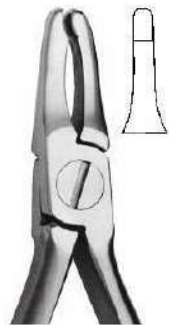

41.5444 JOHNSON
13 cm, Fig. 114



41.5462 GORDON
12,5 cm, Fig. 137



41.5466 REYNOLD
12,5 cm, Fig. 115

A

Abdrucklöffel.....	184-191
Abfallbehälter für Watte.....	92
Abhafter.....	84-85
Abnehmer für Kronen.....	179-182
Abnehmezange für Kupferringe.....	177
Absaugrohre.....	83

Achatspatel.....	158
------------------	-----

Adams Drahtbiegezangen.....	195
Adams -Klammerbiegezange.....	201
Aderer , Drahtbiegezangen.....	198-199
Adson , anatomische Pinzetten.....	56
Adson , chirurgische Pinzetten.....	58
Allisworth , Kofferdam-Lochzange.....	160
Allis , Zahnfleischfaßzang.....	61
Amalgampistolen.....	138-139
Amalgamschneider.....	152-155
Amalgamstopfer.....	135
Ampullenspritzen.....	93
Anatomic , Abdrucklöffel.....	184-190
Anatomische Pinzetten.....	56-57
Andrucker, Band.....	206
Angle , Bogenbiegezange.....	195
Angle , Drahtbiegezange.....	196
Apical , Wurzelheber.....	34

Arterienklemmen.....	60
Artikulationspapierpinzette.....	178
Atraumatische Pinzetten.....	57

Aufwachsinstrumente.....	171
--------------------------	-----

B

Backhaus , Tuchklemmen.....	61
Bandinstrumente.....	206
Barry , Wurzelheber.....	40
Baumgartner , Nadelhalter.....	88
Beale , Modellierinstrument.....	170
Beebee , Kronenschere.....	176
Behälter.....	92
Bein , Wurzelheber.....	31
Bennet , Füllungsinstrumen.....	146
Beyer , Hohlmeißelzange.....	28
Black , Exkavatoren.....	136
Black , Füllungsinstrumente.....	141-145
Black , Gingivalrandschräger.....	130-131
Black , Modellierinstrumente.....	154
Black , Schmelzmeißel.....	130
Blake , Klingenthaler.....	47
Bleischeren.....	176
Blumenthal , Hohlmeißelzange.....	27
Böhler , Hohlmeißelzange.....	28
Böhm , Teleskopkronenzangen.....	183
Bogenbiegezange.....	195

Bone spreader.....	77
Bowdler-Henry's Wundhaken.....	83
Bowmann , Knopfsonden.....	80
Boynston , Nadelhalter.....	90
Brenner, Spiritus.....	172
Buchwald , Zungenspatel.....	86
Bügelbiegezangen.....	199

C

Castroviejo , Nadelhalter.....	87
Castroviejo , Zirkel.....	94
Chirurgische Hämmer.....	74
Chirurgische Kürett.....	69
Chirurgische Nadeln.....	91
Chirurgische Pinzetten.....	58-59
Chirurgische Scheren.....	55
Chompret , Syndesmotome.....	35
Cleoid-Discoid , Modellierinstrumente.....	154
Cogswell , Saugkanüle.....	83
Cohen , Gewebezängchen.....	126
Coleman , Wurzelheber.....	38
College , Zahnpinzetten.....	98-100
Columbia , Universalküretten.....	121
Composite-Instrumente.....	149-151
Contra Winkel-Füllungsinstrumente.....	140-143
Coupland , Wurzelheber.....	33
Crane-Kaplan	59-127
Crane-Kaplan , Zahnreinig.....	112
Crile , Nadelhalter.....	88
Crile-Ryder , Nadelhalte.....	89
Crile-Wood , Nadelhalte.....	89
Zangen für Prothetik und Orthodontie.....	192-207
Cryer , Wurzelheber.....	39
Cryer , Zahnzangen.....	21-23
Cumine , Zahnreiniger.....	111
Cushing , Pinzetten.....	57-59

D

Darby-Perry , Exkavatoren.....	135
Dean , Zahnfleischschere.....	53
DeBaKey , atraumatische Pinzetten.....	57
DeBaKey , Nadelhalter.....	89
Denhart , Mundsperrerr.....	86
Diamantierte Extraktrationszangen.....	13-16
Diamantierte Zahnpinzette.....	98-101
Discoid-cleoid , Modellierinstrumente.....	154
Dosen, Nadel.....	91
Doyen, Nadelhalte.....	88
Doyen-Molt , Mundsperrerr.....	86
Drahtbiegezangen.....	192-202
Drahtschneidezangen.....	203
Drahtspannzangen.....	88-90-204-205
Drehmeißel.....	43
Dycal , Füllungsinstrumente.....	143

E

Economy , Mundspiegelgriff.....	96
Ehrlicke , Abdrucklöffel.....	185-188
Elevatoren.....	65-66
Endodontie-Instrumente.....	162-166
Ermert , Wachsmesser.....	172
Epker , Osteotome.....	73
Exkavatoren.....	132-136-162
Extraktrationszange.....	5-24
Extraktrationszangen, diamantiert.....	13-16

F

Fadenschere.....	50-54
Fadenstopfer, Retraktions.....	177
Fahnenstock , Wachsmesser.....	173
Farabeuf , Wundhaken.....	82
Farbringe für Gracey-Kürett.....	116
Fedi , Parodontal-Meißel.....	71
Feilen, Knochen.....	69
Feilen, Parodontal.....	126
Fingerschützer.....	85
Fissurenzieher.....	151-154-156
Fistel Sond.....	80
Flachmeißel.....	70-73
Flachzangen.....	192-194
Flagg , Zahnpinzetten.....	101
Flohr , Wurzelheber.....	34
Folienschere.....	52-176
Fox , Gewebepinzetten.....	59
Fox , Raspatorien.....	67
Frahm , Modellierinstrument.....	155-170
Frazier , Saugkanüle.....	83
Freer , Elevator.....	66
Freer , Flachmeißel.....	71
Freer , Raspatorien.....	66-68
Frevert , Flachzange.....	194-207
Friedman , Hohlmeißelzange.....	25
Füllungsentferner.....	131
Füllungsinstrumente.....	140-151
Füllungsinstrumente für Composite.....	149-151
Füllungsinstrumente für Wurzelkanal.....	163-165
Furchungsküretten.....	120
Furkationssonden.....	106
Furrer , Kupferingabnehmeza.....	177

G

Gefäßklemm.....	60
Geurtsen , Composite-Schaber.....	149
Geurtsen-Günay , Furchungsküretten.....	120
Gewebehaken.....	81
Gewebepinzetten.....	59
Gewebezängche.....	126
Gillet , Exkavator.....	132
Gillies , chirurgische Pinzette.....	58
Gillies , Wundhaken.....	81
Gingivalrandschrä.....	130-131

Gingivektomie-Besteck.....	127	Hylin , Wurzelheber.....	33	Knochenschneidezangen.....	27
Gingivektomie-Instrumente.....	47-125-127	Hylin-Le Cron , Modellierinstrument.....	204	Knopfsonden.....	80
Gingivektomie-Scheren.....	49-53	I		Kocher , Wundhaken.....	83
Gipsmesser.....	174	Ilic , Gewebezängchen.....	126	Kofferdam-Instrumente.....	160-161
Gipsschneidezange.....	174	Implantologie-Abdrucklöffel.....	191	König, Raspatorien.....	65
Gipsspatel.....	175	Injektionsspritzen.....	93	Konturzangen.....	207
Glick , Wurzelkanal-Stopfer.....	165	Instrumente für Aufwachste.....	171	Kopp , Wurzelheber.....	37
Goldmann-Fox	114-122-125-127	Instrumente, Band.....	206	Kornzangen.....	61
Goldmann-Fox, Parodontologie-Set.....	127	Instrumente, Composite.....	149-151	Krallenheber.....	41
Goldmann-Fox , Zahnfleischscheren.....	49-52	Instrumente, Füllungs.....	140-151	Kramer , chirurgische Küretten.....	69
Gordon , Konturzange.....	207	Instrumente, Gingivektomie.....	125-127	Kramer-Nevins , Parodontal-Meißel.....	71
Goslee , Flachzange.....	193	Instrumente, Keramik.....	169	Kramponzangen.....	202
Gracey Color , Küretten.....	118	Instrumente, Ligatur.....	204-205	Kronenabnehmer.....	179-181
Gracey , Küretten.....	115-117-119-124	Instrumente, Modellier- für Füllungen.....	151-155	Kronenabnehmerzangen.....	182
Gracey , Miniatur-Küretten.....	119	Instrumente, Modellier- für Prothetik.....	168-171	Kronenscheren.....	176
Griffe, Mundspiegel.....	96	Instrumentenbehälte.....	92-128	Küretten, Alveolar.....	62-64
Griffe für Para-Instrumente.....	123	Ivory , Amalgampistolen.....	139	Küretten, Furchungs.....	120
Griffe für Skalpellklingen.....	45-47	Ivory , Kofferdam-Klammern.....	161	Küretten, Gracey.....	115-117-119-124
Gritman , Gipsmesser.....	174	Ivory , Kofferdam-Lochzange.....	160	Küretten, Gracey Color.....	118
Gross , Kornzangen.....	61	Ivory , Matrizenspanner.....	137	Küretten, Miniatur.....	119
Guy , Füllungsinstrumente.....	145	Ivory , Separator.....	137	Küretten, Sinus Lift.....	76
Guy , Zahnzange.....	5	Ivory , Stiftzieher.....	162-178	Küretten, Universal.....	121-122-124
H		Ivory , Zehntelmaß.....	178	Küretten, Wechselgriff.....	123-124
Hämmer, chirurgische.....	74	J		Kupferringabnehmerzange.....	177
Hammer, Plombier.....	139	Jacobson , Nadelhalter.....	88	L	
Hämmer für Techniker.....	172	Jacquette , Zahnreiniger.....	112	Laborzangen.....	192-207
Halsted-Mosquito , Arterienklemmen.....	60	Jarabak , Drahtbiegezange.....	197	Ladmore , Füllungsinstrument.....	144
Beyer , Hohlmeißelzange.....	28	Johnson , Konturzange.....	207	La Grange , Zahnfleischscherer.....	49-51
Halter für Mini-Klingen.....	45	Jones , Tuchklemme.....	61	Lampe, Spiritus.....	172
Handform Mundspiegelgriffe.....	96	Joseph , Zahnfleischscheren.....	53	Landgraf , Zahnpinzette.....	100
Hartmann , Arterienklemmen.....	60	K		Langenbeck , Fingerschützer.....	85
Hauer , Parodontometer.....	107	Kanalscheren.....	176	Langenbeck , Wundhaken.....	82
Hautzangen.....	126	Kanülen, Saug.....	83	Langer , Universalküretten.....	121
Heat transmitter.....	163	Kelly , Arterienklemmen.....	60	Lecluse , Wurzelheber.....	40
Heber, Wurzel.....	29-42	Kelly , Zahnfleischscheren.....	49-53	Le Cron , Modellierinstrumente.....	169
Heber, Wurzelfragment.....	42	Keramikinstrumente.....	169	Lessmann , Wachsmesser.....	173
Heidbrink , Wurzelheber.....	42	Kilner , Wundhaken.....	81	Lexer-Mini , Osteotom.....	72
Heidemann , Spatel.....	148-150	Kinder-Zahnzangen.....	18-20-23	Lichtenberg-Ryder , Nadelhalter.....	90
Helfgen , Abdrucklöffel für die Implantologie.....	191	Kirkland , Parodontalmesser.....	125	Lichtenstein , Spatel für Abdruckmassen.....	175
Hemingway , Scharfe Löffel.....	63	Klammern, Kofferdam.....	161	Lift-ex , Kronenabnehmer.....	180
Hilger , Abhalter.....	85	Klammerzange, Kofferdam.....	161	Ligaturscheren.....	50-54
Hirschfeld , Parodontalfleilen.....	126	Klammerbiegezangen.....	195-202	Ligaturzangen.....	204-205
Hirtenstab, Kronenabnehmer.....	179	Klein , Zahnzangen für Kinder.....	20	Light-Wire, Drahtbiegezange.....	197
Hoe , Zahnreiniger.....	114-127	Klemmen.....	60-61	Lindo-Levien , Wurzelheber.....	36
Hohlkehlzangen.....	200	Klingen für Skalpelle.....	45-46	Littauer , Ligaturschere.....	54
Hohlmeißel.....	72	Klingentferner.....	47	Lochzange, Kofferdam.....	160
Hohlmeißelzangen.....	25-28	Knabberzangen.....	25-28	Locklin , Zahnfleischscherer.....	53
Hollenback , Füllungsinstrument.....	145	Knochenerweiterungssystem.....	77	Löffel, Abdruck.....	184-191
Hollenback , Modellierinstrumente.....	152-168	Knochenfeilen.....	69	Löffel, Scharfe.....	62-64
Holst , Zahnsonde.....	102	Knochenhaltepinzette.....	59	Lötpinzette.....	172
Hopson , Füllungsinstrumente.....	145	Hylin , Modellierinstrument.....	169	London-College , Zahnpinzetten.....	98-100
Hornhammer.....	172			London-Hospital , Wurzelheber.....	38
How , Ligaturzangen.....	205			Lucas , Flach- und Hohlmeißel.....	72
Hygienist , Zahnreiniger.....	110-111-123			Lucas , Scharfe Löffel.....	64
				Luer , Hohlmeißelzange.....	26

Luer-Friedmann , Hohlmeißelzang.....	26
Luks , Wurzelkanal-Stopfer.....	164
Luniatschek , Tamponstopfer.....	80
Luxator Wurzelheber.....	29-30

M

Markierungspinzetten.....	59-127
Markierungsringe für Gracey-Küretten.....	116
Martini , Scharfer Löffel.....	62
Mathieu , Nadelhalter.....	90
Mathieu-Eiselsberg , Nadelhalter.....	90
Matrizenspanner und Matrizen.....	137
Maty Vestibulum-Haken.....	84
Mayo-Hegar , Nadelhalter.....	89
McCall , Universalküretten.....	122-124
McCall , Zahnreiniger.....	113
McKellops , Bügelbiegezangen.....	200
Mead , Chirurgischer Hammer.....	74
Medikamententräger.....	80
Medium , Zahnsonden.....	105
Meißel.....	70-73
Meißel, Schmelz.....	130
Meriam , Zahnspinzetten.....	101
Mershon , Bandandrücker.....	206
Messer, Parodontal.....	47-125-127
Messer, Gips.....	174
Messer, Wachs.....	172-173
Meißel-Instrumente.....	94-178
Method , Behälter.....	92
Metzenbaum , Präparierscheren.....	55
Micro , Nadelhalter.....	18-88
Micro , Resektionsspiegel.....	37
Micro , Zahnfleischscheren.....	51
Micro-Adson , Pinzetten.....	56-58
Middeldorp , Wangenhalter.....	85
Miller , Artikulationspapierpinzette.....	178
Miller-Colburn , Knochenfeilen.....	69
Mini-Friedman , Hohlmeißelzangen.....	25
Mini-Klingen.....	45
Minnesota , Mundwinkelhalter.....	79
Mitchell , Modellierinstrument.....	170
Mitchell , Osteotrimmer.....	111
Modellierinstrumente für Füllungen.....	151-155
Modellierinstrumente für Prothetik.....	168-171
Molt , Mundsperrerr.....	86
Molt , Raspatorien.....	67
Morell , Kronenabnehmer.....	179
Morse , Zahnreiniger.....	113
Mortonson , Füllungsinstrument.....	145
Mosquito , Klemmen.....	60
Müller-Senn , Wundhaken.....	81
Mundsperrerr.....	86
Mundspiegel.....	97
Mundspiegelgriffe.....	96
Mundwinkelhalter.....	85

N

Nabers , Parodontal-Sonde.....	106
Nadelöse.....	91
Nadelhalter.....	87-90
Nähnadel.....	91
Nahtpinzette.....	57-91
Nierenschalen.....	92
Niethammer.....	172
Northbent , Ligaturschere.....	54
Noyes , Zahnfleischscheren.....	53
Nyström , Matrizenspanner.....	137
Nyström , Modellierinstrumente.....	153-168

O

Obwegeser , Raspatorien.....	65
Ochsenbein, Parodontal-Meißel.....	70
Okklusionslöffe.....	190
Oliver-Jones , Bandabnehmmezange.....	208
Optiflex , Zahnsonden.....	104-105
Orban , Parodontalmesser.....	125
Oringer , Lippensterrer und Wangenhalter.....	86
Osteotome.....	72-73
Orthodontische Zangen.....	192-207
Osteotrimmer.....	111

P

Parallelklingen-Skalpellgriffe.....	47
Parmly , Zahnzange.....	21
Parodontal-Besteck.....	127
Parodontalfeile.....	126
Parodontal-Meißel.....	70-71
Parodontalmesser.....	47-125-127
Parodontal-Sonden.....	106-107
Parodontomete.....	107
Partsch , Flachmeißel.....	72
Partsch , Raspatorien.....	66
Perigrip , Abdrucklöffel.....	184
Periotome.....	75
Perry , Zahnspinzetten.....	100
Pfeilform- und Pfeilknickzangen.....	201
Pinzetten, anatomische.....	56-57
Pinzette, Artikulationspapier.....	166
Pinzetten, chirurgische.....	58-59
Pinzetten, Gewebe.....	59
Pinzette, Löt.....	172
Pinzette, Naht.....	57-91
Pinzetten für Silberspitzen.....	99-166
Pinzetten, Taschenmarkierungs.....	59-127
Pinzetten, Zahn.....	98-101
P.K Thomas , für Aufwachstechnik.....	171
Planatoren, Füllungsinstrumente.....	143
Plombierhamme.....	139
Polierer.....	151-156-157
Pott , Wurzelheber.....	41

Präparierscheren.....	55
Prichard , Raspatorien.....	68
Protector , Sterilisierrahmen.....	128
Prothetische Zangen.....	192-207
Pulpakanal-Excavatoren.....	132-162

Q

Quick-Change , Wechselgriff und -spitzen.....	123-124
Quinby , Zahnfleischschere.....	52

R

Rahmen, Kofferdam.....	160
Rahmen, Sterilisier.....	128
Ramushaken.....	83
Rasierkingenhalter.....	45
Raspatorien.....	65-68
Read , Zahnzange.....	7
Reeb , Okklusionslöffel.....	190
Reiniger, Zahn.....	110-114-123-124
Resektions-Spiegel.....	97
Retraktionsfadenstopfer.....	177
Reynold , Konturzange.....	207
Rhodes , Parodontal-Meißel.....	70
Rhodium , Mundspiegel.....	97
Riegner , Modellierinstrument.....	170
Rollet , Wundhaken.....	81
Rotondo ,.....	140-141-143-147-148
Rotondo , Exkavatoren.....	132
Routurier , Zahnzangen.....	11
Roux , Wangenhalter.....	85
Rundzangen.....	196

S

Saugkanülen.....	83
Schaber, Composite.....	149
Schär Wundhaken und Wangenhalte.....	82
Scharfe Löffel.....	62-64
Scaler.....	110-114-123-127
Scheren, chirurgische.....	55
Scheren, Präparie.....	55
Scheren, Folien.....	51-176
Scheren, Kronen- und Blech.....	176
Scheren, Ligatur.....	50-54
Scheren, Zahnfleisch.....	49-53
Schluger , Parodontalfeile.....	126
Schmerzmeißel.....	130
Schneidezangen, Gips.....	174
Schnitzinstrumente für Füllungen.....	151-155
Schwarz , Drahtbiegezange.....	200
Seitenschneider.....	203
Seldin , Raspatorium.....	67
Seldin , Wurzelheber.....	39
Semken , anatomische Pinzetten.....	56

Semken , chirurgische Pinzetten.....	58	Tönnis , Nadelhalter.....	88	Wurzelzangen.....	8-12-14-16-17
Senn-Green , Wundhaken.....	81	Tofflemire , Matrizenspanner.....	137	Wurzelzangen, diamantiert.....	14-16-17
Senn-Müller , Wundhaken.....	81	Tomes , Zahnzange.....	24	Y	
Separator.....	137	Towner , Zahnreiniger.....	114	Young , Drahtbiege zange.....	197
Serviettenhalter.....	96	Trays.....	92-128	Younger-Good , Universalküretten.....	122
Silberspitzeninstrumente.....	149	Treymann , Kronenabnehmer.....	179	Z	
Silberspitzenpinzette.....	99-166	Tuchklemmen.....	61	Zahle , Modellierinstrumente.....	169
Silikonmesser.....	170	U		Zahnpinzetten.....	98-101
Sinus Lift Küretten.....	76	Uffenorde , Scharfe Löffel.....	62	Zahnreiniger.....	110-114-123-127
Sinusboden-Elevatoren.....	78-79	Universal, Kronenabnehmer.....	181	Zahnsonden.....	102-105
Skalpelle, Griffe und Klingan.....	45-47	Universalküretten.....	121-122-124	Zahnfleischfaßzange.....	61
Sonden, Zahn.....	102-105	Universal, Retraktionsfadenstopfer.....	177	Zahnfleisch-Scheren.....	49-53
Sonden, Parodontal.....	106-107	Universal, Zahnsonden.....	102-103	Zahnzangen, amerikanische Form.....	21-24
Sonden, Knopf.....	80	Universal, Zahnzangen.....	21-23-24	Zahnzangen, anatomischer Griff.....	13-16
Sonde, Wurzelkanal.....	105-162	Universal, Zangen für Prothetik und Orthodontie.....	202	Zahnzangen, diamantiert.....	13-16
Spatel für Abdruckmassen.....	175	V		Zahnzangen, englische Form.....	5-20
Spatel für Füllungen.....	141-151	Vestibulumhaken.....	84	Zahnzangen, Kinder.....	18-20-24
Spatel, Zement.....	158-159	Vignon , Modellierinstrument.....	155	Zange für Adams-Klammern.....	201
Spatel, Zungen.....	86	Volkman , Scharfe Löffel.....	62	Zange, Bandabnehme.....	206
Spencer , Ligaturscheren.....	54	W		Zange, Bogenbiege.....	195
Spiegel und -Griffe.....	96-97	WACD , Modellierinstrument.....	154	Zangen, Bügelbiege.....	199
Spina Nasalis -Haken.....	83	Wachsmesser.....	172-173	Zangen, Drahtbiege.....	192-202
Spirituslampe.....	172	Wagner , Zahnfleischschere.....	51	Zangen, Drahtschneide.....	203
Splitterzangen.....	17	Waldsachs-Original , Universalzange.....	202	Zangen, Drahtspann.....	88-90-214-205
Spreizer, Wurzelkanal.....	163	Wangenhalter.....	84-86	Zangen, Flach.....	192-194
Spritzen.....	93	Ward , Füllungsinstrumente.....	146	Zangen, Gewebe.....	126
Sterilisier-Rahmen.....	128	Ward , Modellierinstrumente.....	153-168	Zange, Gipsschneide.....	174
Sternberg , Wangenhalter.....	85	Warwick-James , Wurzelheber.....	38	Zangen, Hohlkehl.....	200
Stevens , Zahnfleischschere.....	50	Wasserspritze.....	93	Zangen, Hohlmeißel.....	25-28
Stieglitz , Zange für Wurzeltragmente.....	17	Wattebehälter.....	92	Zangen, Kinder.....	18-20-24
Stiftzieher.....	162-178	Wechselgriff, Küretten.....	123-124	Zangen, Knochenschneide.....	27
Stoke , Kofferdam-Klammerzange.....	161	Weingart , Ligaturzange.....	205	Zangen, Kofferdam.....	160-161
Stolley , Abdrucklöffel.....	190	West , Raspatorien.....	68	Zangen, Klammerbiege.....	195-202
Stopfer.....	140-146-149-151	Westcott , Polierer.....	156	Zangen, Kontur.....	207
Stopfer, Wurzelkanal.....	164-165	Weston , Zahnsonde.....	103	Zangen, Korn.....	61
Stopfer, Retraktionsfaden.....	177	WHO , Parodontal-Sonden.....	106	Zangen, Kronenabnehme.....	182
Stopfer, Tampon.....	80	Wieder , Zungendrucker.....	86	Zange, Kupferringabnehme.....	177
Sugarman , Gewebezügchen.....	126	Wiland , Modellierinstrument.....	152	Zangen, Ligatur.....	204-205
Super-Cut , Zahnfleischscheren.....	48-53	Williams , Füllungsinstrumente.....	146	Zangen, Pfeilform- und Pfeilknick.....	201
Syndesmotome.....	35	Williams , Parodontal-Sonde.....	106	Zangen für Prothetik und Orthodontie.....	192-207
T		Williger , chirurgische Hämmer.....	74	Zangen, Rund.....	196
Tamponstopfer.....	80	Williger , Elevator.....	65	Zangen, Teleskopkronen.....	183
Tantal , Composite-Instrumente.....	149	Williger , Raspatorien.....	65	Zangen, Wurzel.....	8-12-14-16-17
Taschenmarkierungspinzetten.....	59-127	Williger , Scharfer Löffel.....	62	Zangen, Wurzelstift.....	166
Tasterzirkel.....	178	Winter , Wurzelheber.....	40	Zangen, Zahn.....	5-24
Taylor , Pinzetten.....	57-59	Witzel , Wurzelzangen.....	17	Zange, Zahnfleischfaß.....	61
Taylor , Zahnreiniger.....	112	Woodson , Füllungsinstrumente.....	146	Zehntelmaß.....	178
TC-Pinzetten.....	54	Wundhaken.....	81-83	Zementspatel.....	158-169
TC-Scheren.....	50-52	Wundsonden.....	80	Zirkel.....	94
Technikzangen.....	192-207	Wurzelheber.....	29-42	Zungensspatel.....	86
Teleskopkronenzangen.....	183	Wurzelkanalinstrumente.....	162-166	Zylinder-Ampullen-Spritzen.....	93
Thomas P.K. , für Aufwachtechnik.....	171	Wurzelstiftzange.....	166		
Thorpe , Zahnreiniger.....	110				

A

Adams, clasp bending pliers 201
Adams, wire bending pliers 195
 Adapters, band 206
Aderer, wire bending pliers 198-199
Adson, dissecting forceps 56
Adson, tissue forceps 58
 Agate spatulas 158
Ainsworth, punch forceps 160
 Alcohol lamps 172
Allis, gum seizing forceps 61
 Alveolar curettes 62-64
 Amalgam carriers 138-139
 Amalgam carvers 152-155
 Amalgam pluggers 140-146
 Anatomic, impression trays 184-190
Angle, arch forming pliers 195
Angle, wire bending pliers 196
Apical, root elevators 34
 Applicators, medicine 80
 Applicators, tampon 80
 Arch forming pliers 195
 Arrowhead clasp bending and forming pliers 201
 Artery forceps 60
 Articulation paper forceps 178
 Atraumatic forceps 57

B

Backhaus, towel clips 61
 Band instruments 206
 Bar bending pliers 200
Barry, root elevators 40
Baumgartner, needle holders 88
Beale, carvers 170
Beebee, crown scissors 176
Bein, root elevators 31
Bennet, filling instruments 146
Beyer, rongeur forceps 28
Black, enamel chisels 130
Black, excavators 136
Black, filling instruments 141-145
Black, gingival margin trimmers 130-131
Black, carvers 154
 Blade removers 47
 Blades for scalpel 45-46
Blake, blade holders 47
Blumenthal, rongeur forceps 27
Bhler, rongeur forceps 27
Böhm, pliers for telescopic crowns 183
 Bone chisels and gouges 70-73
 Bone curettes 62-64
 Bone cutting forceps 27
 Bone files 69

Bone holding forceps 59
 Bone spreaders 77
Bowdler-Henry's, retractor 83
 Bowls, kidney 92
Bowmann, probe 80
Boynon, needle holders 90
Brewer, clamp forceps 161
Buchwald, tongue depressors 86
 Burners, alcohol 172
 Burnishers 151-156-157
 Burnishers, root 126

C

Calculus removers 110-114-123-127
 Calibrated probes 106-107
 Calipers 94-178
 Cannula, suction 83
 Carriers, amalgam 138-139
 Cartridge syringes 93
 Carvers for amalgam 151-155
 Carvers for prosthodontia 181-184
 Cases for instruments 92-128
Castroviejo, Calipers 94
Castroviejo, needle holders 87
 Cement spatulas 158-159
 Cheek retractors 84-86
 Chisels 43-70-73
 Chisels, enamel 130
Chompret, syndesmotomes 35
 Clamp forceps 161
 Clamps for rubber dam 161
 Clasp bending pliers 192-202
 Cleaners, tooth 110-114-123-127
 Clips for towels 61
Cogswell, suction tubes 83
Cohen, tissue nippers 126
Coleman, root elevators 38
College, tweezers 98-100
 Colour rings for curettes 116
Columbia, universal curettes 121
 Composite carvers 149-151
 Composite instruments 149-151
 Contouring pliers 207
 Contra-angled filling instruments 140-143
 Copper ring removing pliers 177
 Cotton holders 92
Coupland, root elevators 33
 Crane-Kaplan, pocket markers 59-127
Crane-Kaplan, scalars 112
Crile, needle holders 88
Crile-Ryder, needle holders 89
Crile-Wood, needle holders 89
 Pliers for prosthodontia and orthodontia 92-207
 Crown removers 179-181
 Crown scissors 176
 Crown trial forceps 182

Cryer, extracting forceps 21-23
Cryer, root elevators 39
Cumine, scalars 111
 Curettes, bone 62-64-69
 Curettes, for root depressions 120
 Curettes, for sinus lift 76
 Curettes, Gracey 115-117-119-124
 Curettes, Gracey Color 118
 Curettes, miniatur 119
 Curettes, Quick-change 123-124
 Curettes, surgical 69
 Curettes, universal 121-122-124
Cushing, dissecting forceps 57
Cushing, tissue forceps 59
 Cutters, wire 203
 Cutting instruments 130

D

Darby-Perry, excavators 135
Dean, gum scissors 53
DeBakey, atraumatic forceps 57
DeBakey, needle holders 89
 Decimal calipers 178
Denhart, mouth gags 86
 Depressor, tongue 86
 Diamond coated extracting forceps 13-16
 Diamond coated tweezers 98-101
Discoid-cleoid, carving instruments 154
 Dispensers 92
 Dissecting forceps 56-57
 Dissecting scissors 55
Doyen, needle holders 88
Doyen-Molt, mouth gags 86
 Dressing forceps 61
Dycal, filling instruments 143

E

Economy, mouth mirror handle 96
Ehricke, Anatomic impression trays 185-188
Eiselsberg-Mathieu, needle holders 90
 Elevators 29-42
 Elevators, root fragment 42
 Elevators, periosteal 65-68
 Enamel chisels 130
 Endodontic instruments 162-166
Epker, osteotomes 73
Ermert, wax knives 172
 Excavators 132-136-162
 Explorers 102-105
 Explorers, root canal 105-162
 Extracting forceps 5-23
 Extracting forceps, american pattern 21-24
 Extracting forceps, anatomic handle 13-16
 Extracting forceps, diamond coated 13-16
 Extracting forceps, english pattern 5-20
 Extracting forceps for children 18-20-24

F			
Fahnenstock , wax knives.....	173	Gingivectomy set.....	127
Farabeuf , retractors.....	82	Glick , root canal pluggers.....	165
Fedi , periodontal chisels.....	71	Goldmann-Fox , gingivectomy set.....	127
Files, bone.....	69	Goldmann-Fox , gum scissors.....	49-52
Files, periodontal.....	126	Goldmann-Fox ,.....	114-122-125-127
Filling instruments.....	140-151	Gordon , contouring pliers.....	207
Filling instruments, composite.....	149-151	Goslee , flat nose pliers.....	193
Filling instruments, root canal.....	163-165	Gouges.....	72
Finger protectors.....	85	Gracey , curettes.....	115-117-119-124
Fistula probes.....	80	Gracey , curettes miniatur.....	119
Flagg , tweezers.....	101	Gracey Color , curettes.....	118
Flat nose pliers.....	192-194		
Flohr , root elevators.....	34	Gritman , plaster knives.....	174
Foil scissors, ceramics.....	51-176	Gross , dressing forceps.....	61
Forceps, articulating paper.....	178	Gum nippers.....	126
Forceps, children.....	18-20-24	Gum scissors.....	49-53
Forceps haemostatic.....	60	Gum seizing forceps.....	61
Forceps, clamp.....	161	Guy , extracting forceps.....	5
Forceps, crown trial.....	182	Guy , filling instruments.....	145
Forceps, dissecting.....	56-57		
Forceps, dressing.....	61	H	
Forceps, extracting.....	5-24	Haemostatic forceps.....	60
Forceps, gum seizing.....	61	Halsted-Mosquito , haemostatic forceps.....	60
Forceps, punch.....	160	Hammers.....	74-139-172
Forceps, rongeur.....	25-28	Handles, mouth mirror.....	96
Forceps, root.....	8-12-14-16-17	Handles, perio instruments.....	123
Forceps, root fragment.....	17	Handles, scalpels.....	45-47
Forceps, root pin.....	166	Harris , extracting forceps.....	22
Forceps, silver points.....	99-166	Hartmann Baby-Mosquito ,.....	60
Forceps, suture.....	57-91	Hauer , calibrated probe.....	107
Forceps, tissue.....	58-59	Heat transmitter.....	163
Fox , gum seizing forceps.....	59	Heidbrink , root elevators.....	42
Fox , periosteal elevators.....	67	Heidemann , spatulas.....	148-150
Fragment ejectors.....	42	Helfgen , impression trays for implantology.....	191
Fragment forceps.....	17	Hemingway , bone curettes.....	63
Frahm, carvers.....	155-170	Hilger , retractor.....	85
Frames, rubber dam.....	160	Hirschfeld, files.....	126
Frazier , suction tubes.....	83	Hoe , scalars.....	114-127
Freer , chisels.....	71	Holder for mini scalpel blades.....	45
Freer , periosteal elevators.....	66-68	Holder, needle.....	87-90
Frevert , flat nose liars.....	194-207	Holder, razor blade.....	45
Friedman , rongeur forceps.....	25	Hollenback, carvers.....	152-168
Furcation probes.....	106	Hollenback , filling instruments.....	145
Furrer , copper ring removing pliers.....	177	Holst , explorer.....	102
G		Hopson , filling instruments.....	145
Gags, mouth.....	86	Horn mallets.....	172
Geurtsen , composite carvers.....	149	How, ligature pliers.....	205
Geurtsen-Günay , curettes for root depressions.....	120	Hygienist , scalars.....	110-111-123
Gillet , excavators.....	132	Hylin , carving instruments.....	169
Gillies , retractors.....	81	Hylin , root elevators.....	33
Gillies, tissue forceps.....	58	Hylin-Le Cron , carving instruments.....	169
Gingival cord packers.....	177		
Gingival margin trimmers.....	130-131	I	
Gingivectomy instruments.....	47-125-127	Ilic , tissue nippers.....	126
		Impression trays.....	184
		Impression trays for implantology.....	191
		Impression trays, occlusal.....	190
		Instrument trays.....	92-128
		Instruments, band.....	206
		Instruments, carving.....	151-155
		Instruments, carving for prosthodontia.....	168-171
		Instruments, ceramics.....	169
		Instruments, composite.....	149-151
		Instruments, filling.....	140-151
		Instruments, gingivectomy.....	47-125-127
		Instruments, ligature.....	204-205
		Instruments, waxing-on technique.....	171
		Ivory , Amalgam carriers.....	139
		Ivory , matrix retainers.....	137
		Ivory , post pullers.....	162-178
		Ivory , punch forceps.....	160
		Ivory , rubber dam clamps.....	161
		Ivory , separators.....	137
		Iwanson , decimal calibers.....	178
		J	
		Jacobson , needle holders.....	88
		Jacquette , scalars.....	112
		Jarabak , wire bending pliers.....	197
		Johnson , contouring pliers.....	207
		Jones , towel clips.....	61
		Joseph , gum scissors.....	53
		K	
		Kelly , gum scissors.....	49-53
		Kelly , haemostatic forceps.....	60
		Kidney bowls.....	92
		Kilner , retractors.....	81
		Kirkland , gingivectomy knives.....	125
		Klein , extracting forceps for children.....	20
		Knives, gingivectomy.....	47-125-127
		Knives, plaster.....	174
		Knives, wax.....	172-173
		Kocher , retractors.....	83
		König , periosteal elevators.....	65
		Kopp , root elevators.....	37
		Kramer , surgical curettes.....	69
		Kramer-Ne vins , periodontal chisels.....	71
		L	
		La Grange , gum scissors.....	49-51
		Laboratory pliers.....	192-207
		Ladmore , filling instruments.....	144
		Lamp, alcohol.....	172
		Landgraf , tweezers.....	100
		Langenbeck , finger protectors.....	85
		Langenbeck , retractors.....	82
		Langer , universal curettes.....	121
		Le Cron , carvers.....	169

Lecluse , root elevators.....	40	Mini-Friedman , rongeur forceps.....	25	Periotomes.....	75
Lessmann , wax knives.....	173	Minnesota , cheek and lip retractors.....	85	Perry , tweezers.....	100
Lexer-Mini , osteotome.....	72	Mirrors and handles.....	96-97	Planator , filling instruments.....	143
Lichtenberg-Ryder , needle holders.....	90	Mitchell , carving instruments.....	170	Plaster cutting pliers.....	174
Lichtenstein , spatulas for impression materials.....	175	Mitchell , osteotripping.....	111	Plaster knives.....	174
Lift-ex , crown removers.....	180	Modelling instruments.....	151-155	Plate scissors.....	176
Ligature instruments.....	204-205	Modelling instruments for prosthodontia.....	168-171	Pliers, Adams clasp.....	201
Ligature scissors.....	50-54	Molt , mouth gags.....	86	Pliers, arch forming.....	195
Light-Wire, wire bending plier.....	197	Molt , periosteal elevators.....	67	Pliers arrowhead clasp bending and forming.....	201
Lindo-Levien, root elevators.....	36	Morell , crown removers.....	179	Pliers, band removing.....	206
Lip retractors.....	84-86	Morse , scalars.....	113	Pliers, bar bending.....	199
Littauer , ligature scissors.....	54	Mortonson , filling instruments.....	145	Pliers, clasp bending.....	195-202
Locklin , gum scissors.....	53	Mosquito , haemostatic forceps.....	60	Pliers, contouring.....	207
London-College , tweezers.....	98-100	Mouth gags.....	86	Pliers, copper ring removing.....	177
London-Hospital , root elevators.....	38	Mouth mirrors.....	97	Pliers, flat nose.....	192-194
Lucas , bone curettes.....	64	Müller-Senn , retractors.....	81	Pliers, ligature.....	204-205
Lucas , chisels and gouges.....	72	N		Pliers, plaster cutting.....	174
Luer , rongeur forceps.....	26	Nabers , periodontal probe.....	106	Pliers, prosthodontic and orthodontic.....	192-207
Luer-Friedmann , rongeur forceps.....	26	Napkin holder.....	96	Pliers, round nose.....	196
Luks , root canal pluggers.....	164	Needle case.....	91	Pliers, telescope crown.....	183
Luniatschek , tampon applicators.....	80	Needle holders.....	87-90	Pliers, wire bending.....	192-202
Luxator , root elevators.....	29-30	Needles, suture.....	91	Pliers, wire ligature.....	204-205
M		Nippers, wire.....	203	Pluggers.....	140-146-149-151
Mallets, horn.....	172	Northbent , ligature scissors.....	54	Pluggers, root canal.....	164-165
Mallets, plugging.....	139	Noyes , gum scissors.....	51	Plugging mallets.....	139
Mallets, riveting.....	172	Nyström , matrix retainers.....	137	Pocket markers.....	59-127
Mallets, surgical.....	74	Nyström , carvers.....	153-168	Post pullers.....	162-178
Markers for pockets.....	59-127	O		Pott , root elevators.....	41
Martini , bone curettes.....	62	Obwegeser , periosteal elevators.....	65	Prichard , periosteal elevators.....	68
Mathieu , needle holders.....	90	Occlusal impression trays.....	190	Probes, fistula.....	80
Mathieu-Eiselsberg , needle holders.....	90	Ochsenbein , periodontal chisels.....	70	Probes, periodontal.....	106-107
Matrix retainers and matrices.....	137	Oliver-Jones , band removing pliers.....	206	Protector, finger.....	85
Maty , vestibulum retractor.....	84	Optiflex , explorers.....	104-105	Protector , instrument trays.....	128
Mayo-Hegar , needle holders.....	89	Orban , gingivectomy knives.....	125	Punch forceps.....	160
McCall , scalars.....	113	Oringer , cheek and lip retractor.....	86	Q	
McCall , universal curettes.....	122-124	Osteotomes.....	72-73	Quick-Change , periodontal instruments.....	123-124
McKellops , bar bending pliers.....	200	Osteotripping, Scaler.....	111	Quinby , gum scissors.....	52
Mead , surgical mallets.....	74	P		R	
Measuring probes, pocket.....	106-107	P.K. Thomas , for waxing-on technique.....	171	Ramus retractors.....	83
Medicine applicator.....	80	Packers, gingival cord.....	177	Raspatories.....	65-68
Medium , explorers.....	105	Parallel blade scalpel handle.....	47	Razor blade holders.....	45
Meriam , tweezers.....	101	Parmly , extracting forceps.....	21	Read , extracting forceps.....	7
Mershon , band pushers.....	206	Partsch , chisels and gouges.....	72	Receivers, waste.....	92
Methot , cotton holders.....	92	Partsch , periosteal elevators.....	66	Reeb , occlusal impression trays.....	190
Methot , waste receivers.....	92	Perforators, rubberdam.....	160	Removers, blades.....	47
Metzenbaum , dissecting scissors.....	55	Perigrin , Anatomic impression trays.....	184	Removers, crowns.....	179-181
Micro , gum scissors.....	51	Periodontal chisels.....	70-71	Retainers, matrix.....	137
Micro, mirrors.....	97	Periodontal files.....	126	Retractors.....	81-83
Micro , needle holders.....	87-88	Periodontal knives.....	47-125-127	Reynold , contouring pliers.....	207
Micro-Adson , dissecting forceps.....	56	Periodontal probes.....	106-107	Rhodes , periodontal chisel.....	83
Micro-Adson , tissue forceps.....	58	Periosteal elevators.....	65-68	Rhodium , mouth mirrors.....	97
Middeldorpf , cheek retractors.....	85			Riegner , carving instruments.....	170
Miller , articulating paper forceps.....	178			Riveting mallets.....	172
Miller-Colburn , bone files.....	69			Rollet, retractors.....	81
Mini scalpel blades.....	45				

Romerowski , burnishers.....	157
Rongeur forceps.....	25-28
Root burnishers.....	126
Root canal instruments.....	162-166
Root elevators.....	29-42
Root extracting forceps.....	8-12-14-16-17
Root extracting forceps, diamond coated.....	4-16-17
Rotondo , excavators.....	132
Rotondo , filling instruments.....	140-141-143-147-148
Round nose pliers.....	196
Routurier , extracting forceps.....	11
Roux , cheek and lip retractors.....	85
Rubber dam instruments.....	160-161
S	
Scalers.....	110-11-123-127
Scalpel blades and handles.....	45-47
Schäfer , combined wound and cheek retractor.....	82
Schluger , periodontal file.....	126
Schwarz , wire bending pliers.....	200
Scissors, crown and plate.....	176
Scissors, foil.....	51-176
Scissors, gum.....	49-53
Scissors, ligature.....	52-54
Scissors, surgical.....	55
Seldin , periosteal elevator.....	67
Seldin , root elevators.....	39
Semken , dissecting forceps.....	56
Semken , tissue forceps.....	58
Senn-Green , retractors.....	81
Senn-Müller , retractors.....	81
Separator.....	137
Sharp spoons.....	62-64
Silicon knife.....	170
Silver points instruments.....	149
Silver points forceps.....	99-166
Sinus lift curettes.....	76
Sinus lift elevators.....	78-79
Soldering tweezers.....	172
Spatulas, cement.....	158-159
Spatulas, filling material.....	141-151
Spatulas, impression material.....	175
Spatulas, plaster.....	175
Spatulas, tongue.....	86
Spencer , ligature scissors.....	54
Spina Nasalis , retractors.....	83
Spreaders, root canal.....	163
Spoons, sharp.....	62-64
Sternberg , cheek and lip retractors.....	85
Stevens , gum scissors.....	50
Stieglitz , root fragment forceps.....	17
Stoke , clamp forceps.....	161
Stolley , impression trays.....	190

Suction tubes.....	83
Sugarman , tissue nippers.....	126
Super-Cut , gum scissors.....	48-53
Surgical curettes.....	69
Surgical mallets.....	74
Surgical scissors.....	55
Suture forceps.....	57-93
Suture needles.....	93
Suture scissors.....	50-54
Syndesmotomes.....	35
Syringes.....	93
T	
Tampon applicators.....	80
Tantal , composite instruments.....	149
Taylor , dissecting forceps.....	57
Taylor , scalars.....	112
Taylor , tissue forceps.....	59
TC dissecting forceps.....	56
TC scissors.....	50-52
Telescope crown pliers.....	183
Thomas P.K. , for waxing-on technique.....	171
Thorpe , scalars.....	110
Tissue forceps.....	58-59
Tissue nippers.....	126
Tofflemire , matrix retainers.....	137
Tomes , extracting forceps.....	24
Tongue depressors.....	86
Tönnis , needle holders.....	88
Towel clips.....	61
Towner , scalars.....	114
Trays for instruments.....	92-128
Treymann , crown removers.....	179
Tubes, suction.....	83
Tweezers.....	98-101
Tweezers, diamond coated.....	98-101
Tweezers, soldering.....	172
U	
Uffenorde , bone curettes.....	62
Universal crown removers.....	181
Universal curettes.....	121-122-124
Universal explorers.....	102-103
Universal extracting forceps.....	21-23-24
Universal gingival cord packer.....	177
Universal pliers for prosthodontia and orthodontia.....	202
V	
Vestibulum retractors.....	84
Vignon , carvers.....	155
Volkman , bone curettes.....	62

W	
WACD , carvers.....	154
Wagner , gum scissors.....	51
Waldsachs-Original , universal pliers.....	202
Ward , carvers.....	153-168
Ward, filling instruments.....	146
Warwick-James , root elevators.....	38
Waste receiver.....	92
Water syringe.....	93
Wax knives.....	172-173
Waxing-on technique.....	171
Weingart , ligature pliers.....	205
West , periosteal elevators.....	68
Westcott , burnishers.....	156
Weston , explorer.....	103
WHO , periodontal-probe.....	106
Wieder , tongue depressors.....	86
Wiland , carvers.....	152
Williams , filling instruments.....	146
Williams , periodontal probe.....	106
Williger , bone curettes.....	62
Williger , mallets.....	74
Williger , periosteal elevators.....	65
Winter , root elevators.....	40
Wire bending pliers.....	192-202
Wire cutters.....	203
Witzel , forceps for roots.....	17
Woodson , filling instruments.....	146
Y	
Young , wire bending pliers.....	197
Younger-Good , universal curettes.....	122
Z	
Zahle , carving instruments.....	169