

E.N.T CATALOG



Whatsapp & Call: +92 3034515151

Medical staff Order online , While we offer Distributors and businesses bulk orders with custom branding



Table of Contents

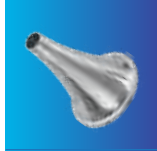

Otology



Rhinology

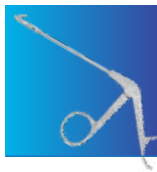

Sinus Surgery



Larynx & Tonsil



Microlaryngology



Maxillofacial

Otology

- Ear Polypus Forceps
- Ear Syringes
- Micro Ear Forceps
- Micro Ear Scissors
- Micro Ear Knives
- Micro Ear Hooks
- Micro Ear Needles
- Micro Ear Curettes
- Micro Ear Speculas
- Mastoid Rongeurs
- Tuning Forks

BLACK COATED

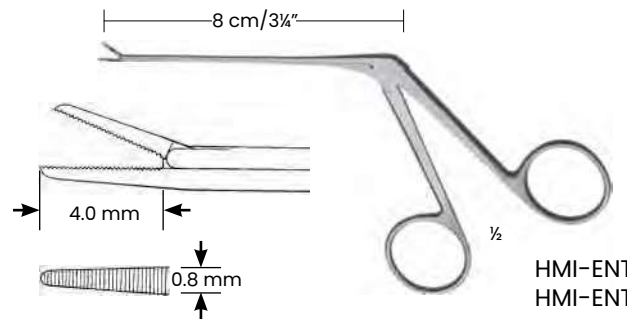
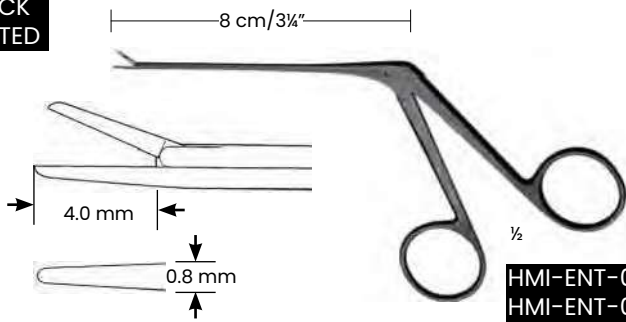

Straight, smooth	Straight, serrated	Bent upwards, serrated	Right, serrated	Left, serrated
HMI-ENT-001 HMI-ENT-006	HMI-ENT-002 HMI-ENT-007	HMI-ENT-003 HMI-ENT-008	HMI-ENT-004 HMI-ENT-009	HMI-ENT-005 HMI-ENT-010

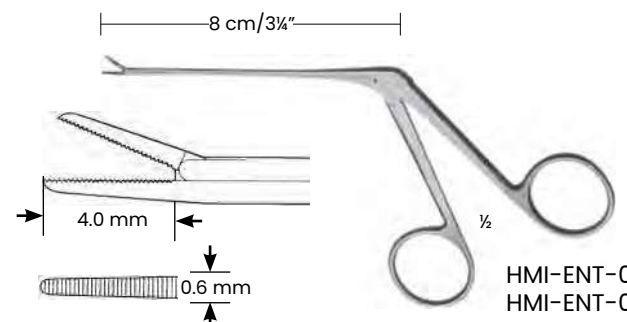
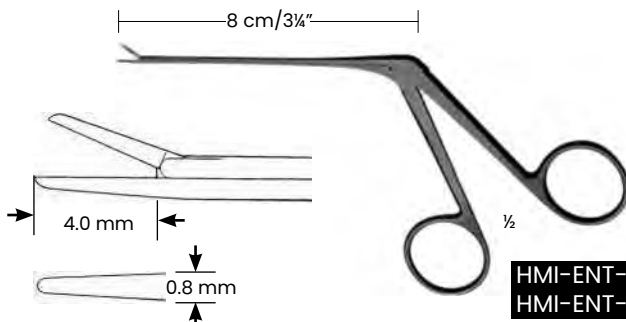

Straight, smooth	Upwards, serrated	Right, serrated	Left, serrated
HMI-ENT-011 HMI-ENT-015	HMI-ENT-012 HMI-ENT-016	HMI-ENT-013 HMI-ENT-017	HMI-ENT-014 HMI-ENT-018

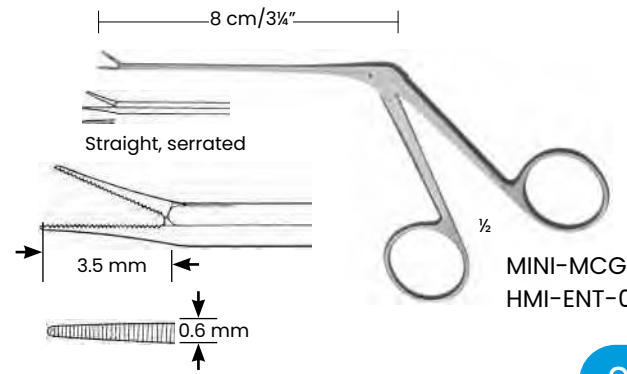
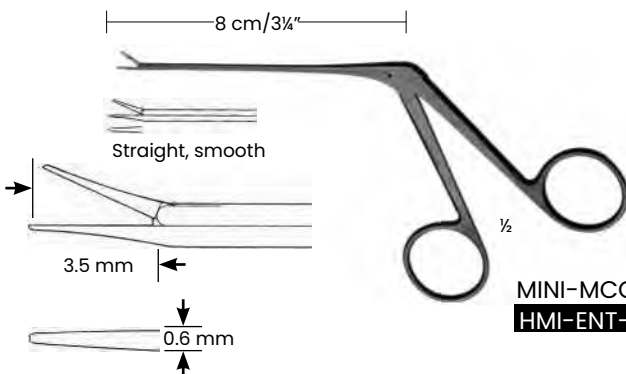

**BLACK
 COATED**

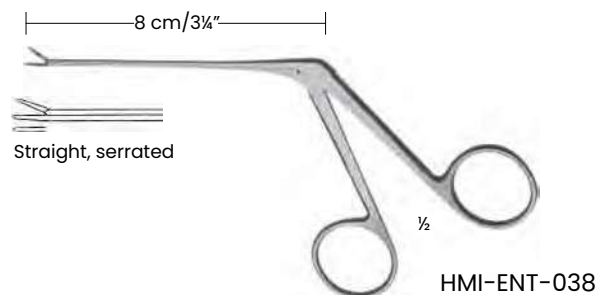
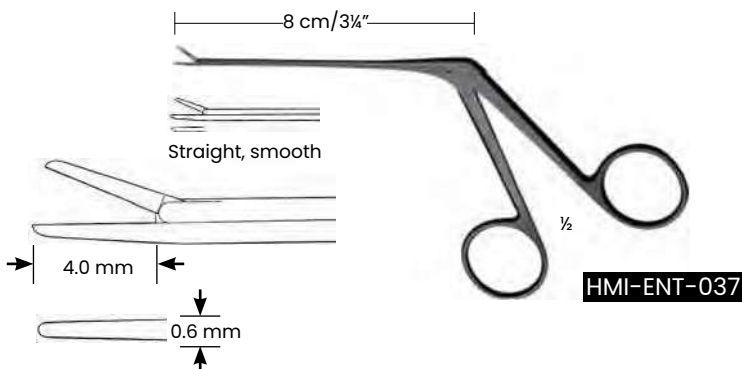
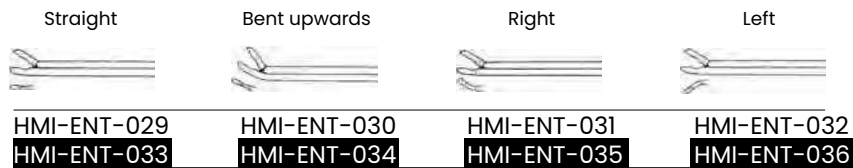
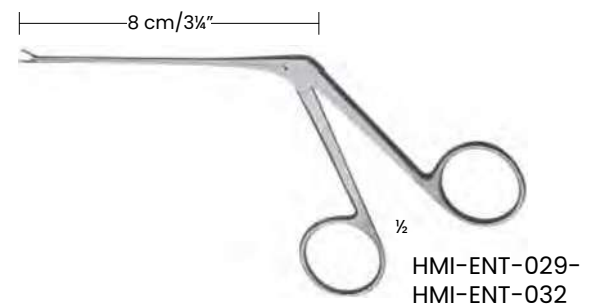
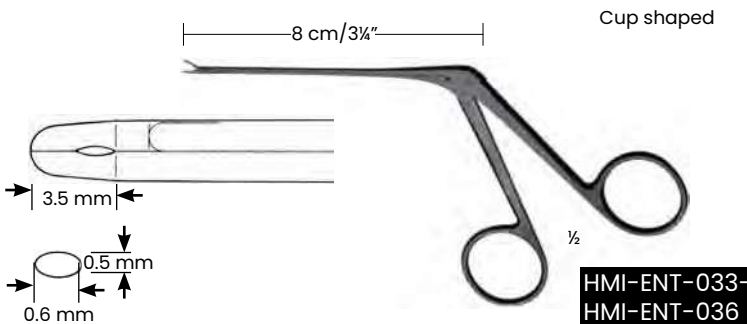
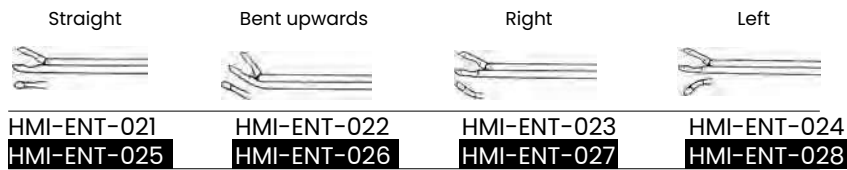
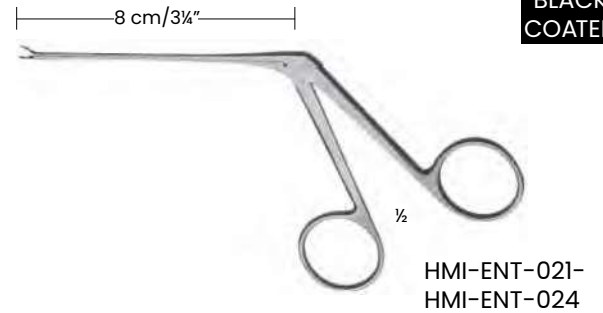
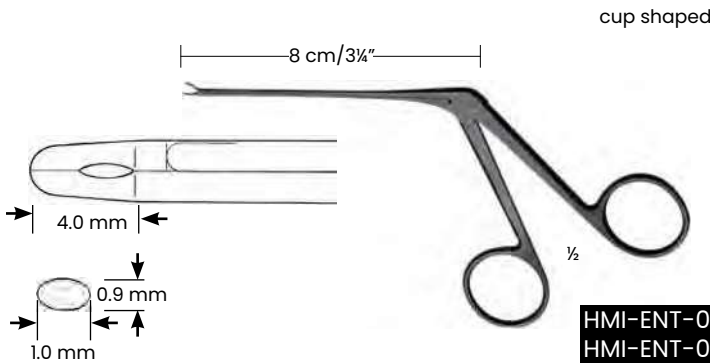

Let Us know if you could not find what you are looking for

BLACK COATED

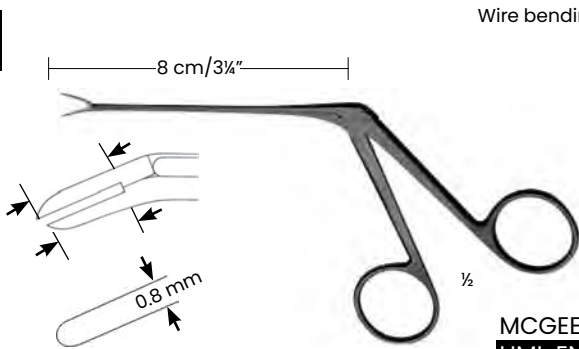

Wire bending forceps

MC GEE
HMI-ENT-041
HMI-ENT-042

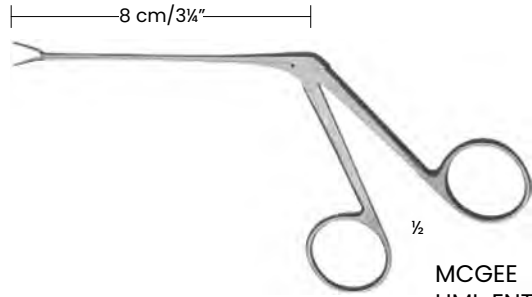

MC GEE
HMI-ENT-039
HMI-ENT-040

Angled downward

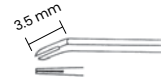

0.8 x 3.5 mm
HMI-ENT-039
HMI-ENT-041

Angled downward

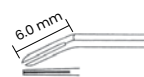

0.8 x 6.0 mm
HMI-ENT-040
HMI-ENT-042

Malleus nipper

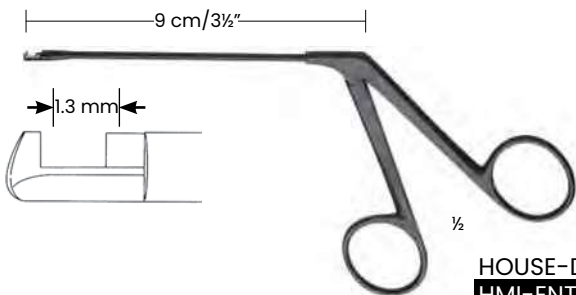

HOUSE-DIETER
HMI-ENT-047
HMI-ENT-050



HOUSE-DIETER
HMI-ENT-043
HMI-ENT-046

Up cutting	Down cutting	Right cutting	Left cutting
HMI-ENT-043 HMI-ENT-047	HMI-ENT-044 HMI-ENT-048	HMI-ENT-045 HMI-ENT-049	HMI-ENT-046 HMI-ENT-050

Introducing Forceps, for teflon prosthesis

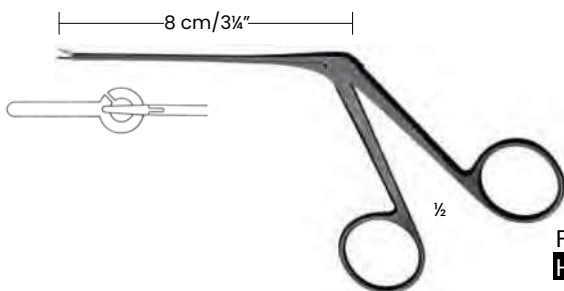

FULLER
HMI-ENT-052

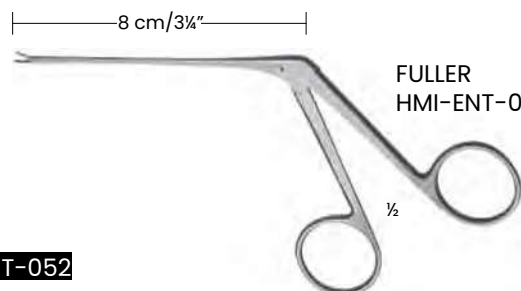

FULLER
HMI-ENT-051

Let Us know if you could not find what you are looking for

BLACK COATED

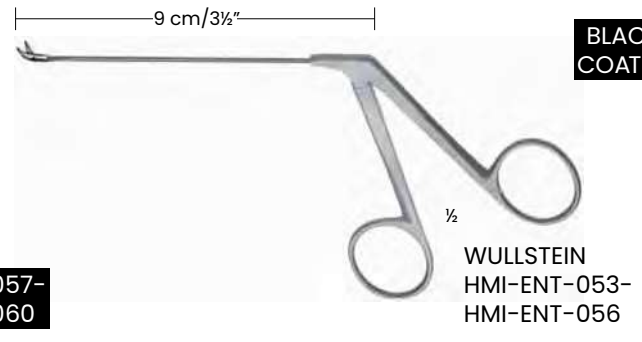
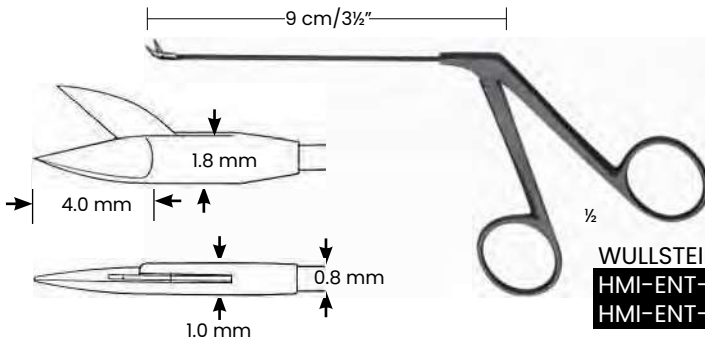

WULLSTEIN
HMI-ENT-057-
HMI-ENT-060

WULLSTEIN
HMI-ENT-053-
HMI-ENT-056

Straight

Bent upwards

Right

Left

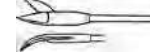

HMI-ENT-053
HMI-ENT-057

HMI-ENT-054
HMI-ENT-058

HMI-ENT-055
HMI-ENT-059

HMI-ENT-056
HMI-ENT-060

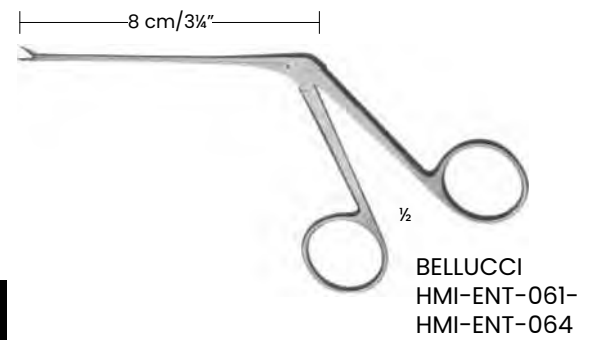
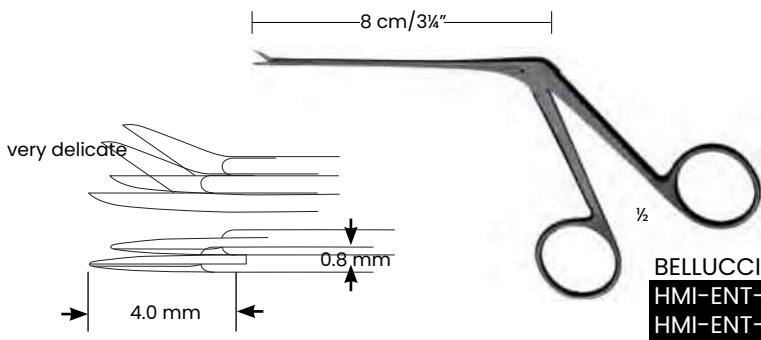

BELLUCCI
HMI-ENT-065-
HMI-ENT-068

BELLUCCI
HMI-ENT-061-
HMI-ENT-064

Straight

Bent upwards

Right

Left



HMI-ENT-061
HMI-ENT-065

HMI-ENT-062
HMI-ENT-066

HMI-ENT-063
HMI-ENT-067

HMI-ENT-064
HMI-ENT-068

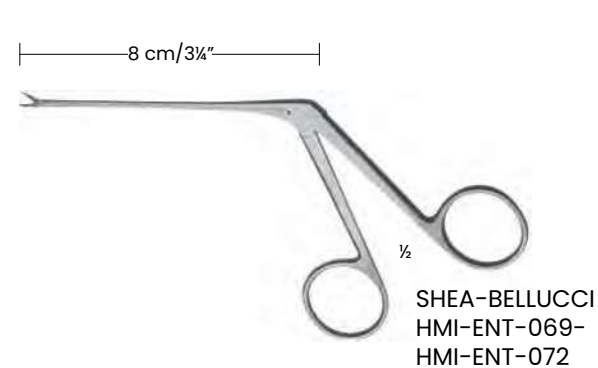
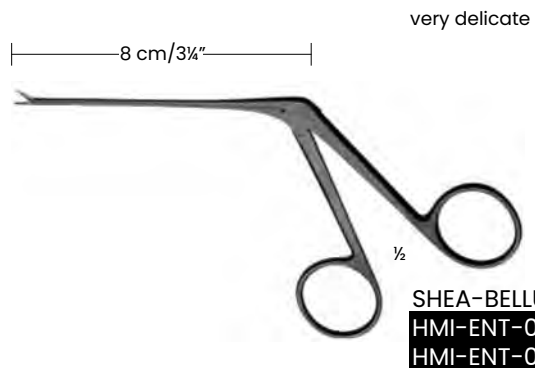

SHEA-BELLUCCI
HMI-ENT-073-
HMI-ENT-076

SHEA-BELLUCCI
HMI-ENT-069-
HMI-ENT-072

Straight

Bent upwards

Right

Left



HMI-ENT-069
HMI-ENT-073

HMI-ENT-070
HMI-ENT-074

HMI-ENT-071
HMI-ENT-075

HMI-ENT-072
HMI-ENT-076

Let Us know if you could not find what you are looking for

Sickle knife



SCHUKNECHT
HMI-ENT-077
14.5 cm/5¾"

Roller knives

Vertical



SCHUKNECHT
HMI-ENT-078
15.5 cm/6"

Horizontal



SCHUKNECHT
HMI-ENT-079
15.5 cm/6"

Micro knife



ROSEN
15 cm/6"



Diameter

Ø 1.0 mm	HMI-ENT-083	HMI-ENT-090
Ø 1.4 mm	HMI-ENT-084	
Ø 1.5 mm		HMI-ENT-091
Ø 1.6 mm	HMI-ENT-085	HMI-ENT-092
Ø 2.0 mm	HMI-ENT-080	HMI-ENT-086
Ø 2.3 mm	HMI-ENT-081	HMI-ENT-094
Ø 2.5 mm	HMI-ENT-082	HMI-ENT-095
Ø 2.6 mm	HMI-ENT-087	HMI-ENT-096
Ø 2.8 mm	HMI-ENT-088	HMI-ENT-097
Ø 3.0 mm	HMI-ENT-089	HMI-ENT-098

Sickle knife



WULLSTEIN
HMI-ENT-099
15.5 cm/6"

Mucosa knife



TABB
HMI-ENT-100
15.5 cm/60"

Flap knife



PLESTER
HMI-ENT-101
15 cm/6"



SEXTON
HMI-ENT-102
18 cm/7"

Ear knives



SEXTON
HMI-ENT-103
17 cm/6¾"

Bayonet



SEXTON-GERZOG
HMI-ENT-104
17 cm/6¾"

Tympanum needles



POLITZER
HMI-ENT-105
17.5 cm/7"

Furuncle knife



POLITZER
HMI-ENT-106
16 cm/6¼"



POLITZER
HMI-ENT-107
15.5 cm/6"



POLITZER
HMI-ENT-108
16 cm/6¼"



LUCAE
HMI-ENT-109
18 cm/7"



LUCAE
HMI-ENT-110
17.5 cm/7"

Micro ear needles



16 cm/6¼"



BARBARA
HMI-ENT-111



BARBARA
HMI-ENT-112



BARBARA
HMI-ENT-113



ROSEN
HMI-ENT-114

Micro ear hooks

Hook



0.3 mm HMI-ENT-115
0.6 mm HMI-ENT-116
1.0 mm HMI-ENT-117

Hook



0.3 mm HMI-ENT-118
0.6 mm HMI-ENT-119
1.0 mm HMI-ENT-120
1.2 mm HMI-ENT-121
1.5 mm HMI-ENT-122
2.0 mm HMI-ENT-123
2.5 mm HMI-ENT-124

Hook



HMI-ENT-125
HMI-ENT-126
HMI-ENT-127
HMI-ENT-128
HMI-ENT-129
HMI-ENT-130
HMI-ENT-131

Micro ear needles

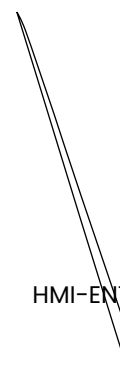

HMI-ENT-134

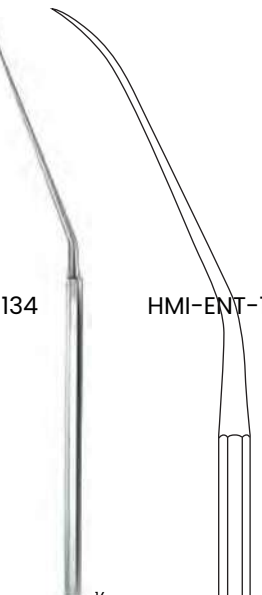

HMI-ENT-135

11 11
BARBARA
15.5 cm/6"

Let Us know if you could not find what you are looking for

Micro ear hooks

	bent upwards 90°	angled 90°					
	0.3 mm HMI-ENT-136	HMI-ENT-139					
	0.6 mm HMI-ENT-137	HMI-ENT-140					
	1.0 mm HMI-ENT-138	HMI-ENT-141					

Micro ear hooks

	25°	25°	25°	45°
	HMI-ENT-146 Ø 0.3 mm	HMI-ENT-147 Ø 0.6 mm	SHAMBAUGH HMI-ENT-150 Ø 1.0 mm	HMI-ENT-151 Ø 0.3 mm

for footplate

	bent upwards	angled		
	MCGEE	MCGEE		
	0.5 mm HMI-ENT-142	HMI-ENT-144		
	1.0 mm HMI-ENT-143	HMI-ENT-145		

	45°	45°	Blunt Exploring hook blunt 45°	Attic dissector 90°
	HMI-ENT-148 Ø 0.6 mm	SHAMBAUGH HMI-ENT-149 Ø 1.0 mm	SHEA HMI-ENT-152 Ø 2.0 mm	AUSTIN HMI-ENT-153 Ø 3.0 mm

15.5 cm / 6 1/4"

15 cm / 6"

Ear hooks

HMI-ENT-154	HMI-ENT-155	HMI-ENT-156 Fig. 1	HMI-ENT-157 Fig. 2	HMI-ENT-158 Fig. 3	HMI-ENT-159 Fig. 4	HMI-ENT-163 Fig. 1	HMI-ENT-164 Fig. 2	HMI-ENT-165 Fig. 3	HMI-ENT-166 Fig. 1
-------------	-------------	-----------------------	-----------------------	-----------------------	-----------------------	-----------------------	-----------------------	-----------------------	-----------------------

Ear hooklets

HMI-ENT-160 Fig. 5	HMI-ENT-161 Fig. 6	HMI-ENT-162 Fig. 7	HMI-ENT-165 Fig. 3	HMI-ENT-166 Fig. 2
-----------------------	-----------------------	-----------------------	-----------------------	-----------------------

DAY
17 cm / 6 3/4"

WAGENER
14 cm / 5 1/2"

LUCAE
14 cm / 5 1/2"

HARTMANN
HMI-ENT-166
16 cm / 6 1/4"

Let Us know if you could not find what you are looking for

Micro hooks, Picks

	Straight	25° Angled
0.3 mm	HMI-ENT-167	HMI-ENT-171
0.5 mm	HMI-ENT-168	HMI-ENT-172
0.6 mm	HMI-ENT-169	HMI-ENT-173
1.0 mm	HMI-ENT-170	HMI-ENT-174

	45° Angled	90° Angled
0.3 mm	HMI-ENT-175	HMI-ENT-183
0.5 mm	HMI-ENT-176	HMI-ENT-184
0.6 mm	HMI-ENT-177	HMI-ENT-185
1.0 mm	HMI-ENT-178	HMI-ENT-186
1.2 mm	HMI-ENT-179	HMI-ENT-187
1.5 mm	HMI-ENT-180	HMI-ENT-188
2.0 mm	HMI-ENT-181	HMI-ENT-189
2.5 mm	HMI-ENT-182	HMI-ENT-190

SHAMBAUGH
 16 cm/6¼"

Micro otology hooks

	25° Upwards	25° Downwards
0.3 mm	HMI-ENT-191	HMI-ENT-194
0.6 mm	HMI-ENT-192	HMI-ENT-195
1.0 mm	HMI-ENT-193	HMI-ENT-196

	45° Upwards	45° Downwards
0.3 mm	HMI-ENT-197	HMI-ENT-200
0.6 mm	HMI-ENT-198	HMI-ENT-201
1.0 mm	HMI-ENT-199	HMI-ENT-202

	90° Upwards	90° Downwards
0.3 mm	HMI-ENT-203	HMI-ENT-206
0.6 mm	HMI-ENT-204	HMI-ENT-207
1.0 mm	HMI-ENT-205	HMI-ENT-208

15.5 cm/6¼"

Micro dissectors

	angled to right	angled to left
HMI-ENT-209	15 cm/6"	HMI-ENT-211
HMI-ENT-210	15.5 cm/6¼"	HMI-ENT-212

FISCH

	angled to right	angled to left
HMI-ENT-213	Ø 3.5 mm	HMI-ENT-215
HMI-ENT-214	Ø 4.5 mm	HMI-ENT-216

HOUSE
 15.5 cm/6¼"

Micro measuring rods

HMI-ENT-213 Ø 3.5 mm
 HMI-ENT-215 Ø 4.0 mm
 HMI-ENT-214 Ø 4.5 mm
 HMI-ENT-216 Ø 5.0 mm

Foreign body levers

MOLDENHAUER
 HMI-ENT-217
 16 cm/6¼"

ZAUFAL
 HMI-ENT-218
 15 cm/6"

Let Us know if you could not find what you are looking for

Periosteal elevators

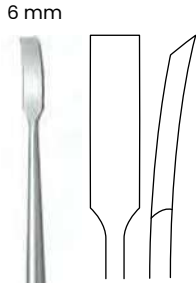

LEMPERT
 HMI-ENT-219
 20.5 cm/8"

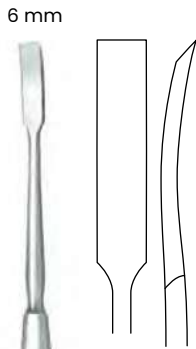

LEMPERT
 HMI-ENT-220
 18 cm/7"

Ear scoop sharp



LEMPERT
 21.5 cm/8½"

- HMI-ENT-221 Fig. 1
- HMI-ENT-222 Fig. 2
- HMI-ENT-223 Fig. 3
- HMI-ENT-224 Fig. 4
- HMI-ENT-225 Fig. 5

Foreign body instrument

Micro ear periosteal elevator



ROSEN
 HMI-ENT-226
 15 cm/6"



WEBER-LOCH
 HMI-ENT-227
 17 cm/6"



SHAPLEIGH
 15 cm/6"



HMI-ENT-228
 Fig. 1



HMI-ENT-229
 Fig. 2

Micro curettes

- Ø 1.0 mm
- Ø 1.5 mm
- Ø 1.0 mm



HMI-ENT-230



Ø 1.2 mm



HMI-ENT-231



Ø 1.8 mm



HMI-ENT-232



Ø 1.2 mm



HOUSE
 14.5 cm/5¾"

Let Us know if you could not find what you are looking for

Ear curretes



sharp							
	HMI-ENT-233	HMI-ENT-234	HMI-ENT-235	HMI-ENT-236	HMI-ENT-237	HMI-ENT-238	HMI-ENT-239
	1.8 mm	2.1 mm	2.6 mm	3.2 mm	3.7 mm	4.1 mm	4.4 mm
	Fig. 000	Fig. 00	Fig. 0	Fig. 1	Fig. 2	Fig. 3	Fig. 4
blunt							
	HMI-ENT-240	HMI-ENT-241	HMI-ENT-242	HMI-ENT-243	HMI-ENT-244	HMI-ENT-245	HMI-ENT-246
	1.8 mm	2.1 mm	2.6 mm	3.2 mm	3.7 mm	4.1 mm	4.4 mm
	Fig. 000	Fig. 00	Fig. 0	Fig. 1	Fig. 2	Fig. 3	Fig. 4
sharp							
	HMI-ENT-247	HMI-ENT-248	HMI-ENT-249	HMI-ENT-250	HMI-ENT-251	HMI-ENT-252	HMI-ENT-253
	1.8 mm	2.1 mm	2.6 mm	3.2 mm	3.7 mm	4.1 mm	4.4 mm
	Fig. 000	Fig. 00	Fig. 0	Fig. 1	Fig. 2	Fig. 3	Fig. 4
blunt							
	HMI-ENT-254	HMI-ENT-255	HMI-ENT-256	HMI-ENT-257	HMI-ENT-258	HMI-ENT-259	HMI-ENT-260
	1.8 mm	2.1 mm	2.6 mm	3.2 mm	3.7 mm	4.1 mm	4.4 mm
	Fig. 000	Fig. 00	Fig. 0	Fig. 1	Fig. 2	Fig. 3	Fig. 4

Ear scoop sharp

Ear Scoops

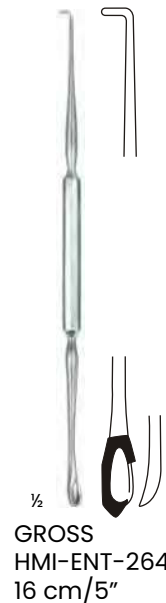

Ear loops





HMI-ENT-268
 Ø 3 mm
 Fig. 0



HMI-ENT-269
 Ø 4 mm
 Fig. 1



HMI-ENT-270
 Ø 5 mm
 Fig. 2



HMI-ENT-271
 Ø 6 mm
 Fig. 3



HMI-ENT-272
 Ø 7.5 mm
 Fig. 4



HARTMANN
 3.6 cm / 1 1/2"

Fig.

Set of 3	0-3	HMI-ENT-273
Set of 3	2-4	HMI-ENT-274
Set of 4	1-4	HMI-ENT-274

Chrome plated



HARTMANN

Fig.

Set of 3	1, 2, 4	HMI-ENT-284
Set of 4	3, 5, 7, 9	HMI-ENT-285
Set of 4	2, 4, 6, 8	HMI-ENT-286



HMI-ENT-275
 Ø 3 mm
 Fig. 1



HMI-ENT-280
 Ø 4 mm
 Fig. 2



HMI-ENT-276
 Ø 4.5 mm
 Fig. 3



HMI-ENT-281
 Ø 5.0 mm
 Fig. 4



HMI-ENT-277
 Ø 5.5 mm
 Fig. 5



HMI-ENT-282
 Ø 6.0 mm
 Fig. 6



HMI-ENT-278
 Ø 6.5 mm
 Fig. 7



HMI-ENT-283
 Ø 7.0 mm
 Fig. 8



HMI-ENT-279
 Ø 7.5 mm
 Fig. 9



HMI-ENT-287
 4.5 x 5 mm



HMI-ENT-288
 5.5 x 6 mm



HMI-ENT-289
 6.5 x 7 mm



HMI-ENT-290
 7.5 x 8 mm

Chrome plated, Oval



HARTMANN



HMI-ENT-293
 Ø 4 mm
 Fig. 1



HMI-ENT-294
 Ø 5 mm
 Fig. 2



HMI-ENT-295
 Ø 6 mm
 Fig. 3



HMI-ENT-296
 Ø 7.5 mm
 Fig. 4



TOYNBEE
 3.6 cm / 1 1/2"

Fig.

Set for 3	2 - 4	HMI-ENT-291
Set for 4	1 - 4	HMI-ENT-292



HMI-ENT-297
 Ø 8.2 mm



HMI-ENT-308
 9.0 mm



HMI-ENT-319
 9.0 mm



HMI-ENT-298
 Ø 7.7 mm



HMI-ENT-309
 8.5 mm



HMI-ENT-320
 8.5 mm



HMI-ENT-299
 Ø 7.2 mm



HMI-ENT-310
 8.0 mm



HMI-ENT-321
 8.0 mm



HMI-ENT-300
 Ø 6.7 mm



HMI-ENT-311
 7.5 mm



HMI-ENT-322
 7.5 mm



HMI-ENT-301
 Ø 6.3 mm



HMI-ENT-312
 7.0 mm



HMI-ENT-323
 7.0 mm



HMI-ENT-302
 Ø 5.8 mm



HMI-ENT-313
 6.5 mm



HMI-ENT-324
 6.5 mm



HMI-ENT-303
 Ø 5.3 mm



HMI-ENT-314
 6.0 mm



HMI-ENT-325
 6.0 mm



HMI-ENT-304
 Ø 4.8 mm



HMI-ENT-315
 5.5 mm



HMI-ENT-326
 5.5 mm



HMI-ENT-305
 Ø 4.3 mm



HMI-ENT-316
 5.0 mm



HMI-ENT-327
 5.0 mm

Satin finish, round



½

FARRIOR



HMI-ENT-306
 Ø 3.8 mm



HMI-ENT-307
 Ø 3.3 mm

Satin finish, oval

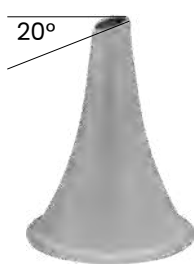

½

FARRIOR



HMI-ENT-317
 4.5 mm



HMI-ENT-318
 4.0 mm

Satin finish, oval



½

FARRIOR



HMI-ENT-328
 4.5 mm



HMI-ENT-329
 4.0 mm



HMI-ENT-344
 Ear specula storage rack



HMI-ENT-330
 Ø 11.5 mm
 Fig. 7



HMI-ENT-331
 Ø 11.5 mm
 Fig. 6



HMI-ENT-332
 Ø 10.5 mm
 Fig. 5



HMI-ENT-333
 Ø 8.5 mm
 Fig. 4



HMI-ENT-334
 Ø 7.5 mm
 Fig. 3



HMI-ENT-335
 Ø 6.5 mm
 Fig. 2



HMI-ENT-336
 Ø 5.5 mm
 Fig. 1



HMI-ENT-337
 11.5 mm
 Fig. 6



HMI-ENT-338
 10.5 mm
 Fig. 5



HMI-ENT-339
 9.5 mm
 Fig. 4



HMI-ENT-340
 8.5 mm
 Fig. 3



HMI-ENT-341
 7.5 mm
 Fig. 2



HMI-ENT-342
 6.5 mm
 Fig. 1



HMI-ENT-343
 Fig. 1-6
 Complete set



Let Us know if you could not find what you are looking for



FRENCH
HMI-ENT-345
C² 16



FRENCH
HMI-ENT-346
C¹ 32



HARTMANN
HMI-ENT-347
C 64



HARTMANN
HMI-ENT-348
C 128



HARTMANN
HMI-ENT-349
C¹ 256

Let Us know if you could not find what you are looking for

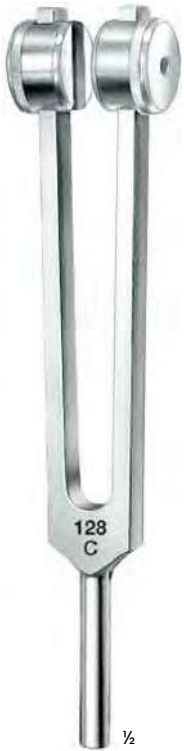

with dampers

ALUMINIUM



HMI-ENT-355
 Set of 5
 (C 128 Hz - C 2048 Hz)

HMI-ENT-350
C128

HMI-ENT-351
C256

HMI-ENT-352
C512

HMI-ENT-353
C1024

HMI-ENT-354
C2048



HARTMANN
HMI-ENT-356
C128

HARTMANN
HMI-ENT-357
C¹ 256

HARTMANN
HMI-ENT-358
C² 512

HARTMANN
HMI-ENT-359
C³ 1024

HARTMANN
HMI-ENT-360
C⁴ 2048

HARTMANN
HMI-ENT-361
C⁵ 4096

Let Us know if you could not find what you are looking for

Tuning Forks



LUCAE
HMI-ENT-362
C128



LUCAE
HMI-ENT-363
C¹ 256



LUCAE
HMI-ENT-364
C² 512

HMI-ENT-365
Socket only



LUCAE
HMI-ENT-366
C³ 1024



LUCAE
HMI-ENT-367
C⁴ 2048



LUCAE
HMI-ENT-368
C⁵ 4096



LUCAE
HMI-ENT-369
C 128

HMI-ENT-370
Socket only

Let Us know if you could not find what you are looking for



with hammer, pinwheel, brush & wheel for Neurc

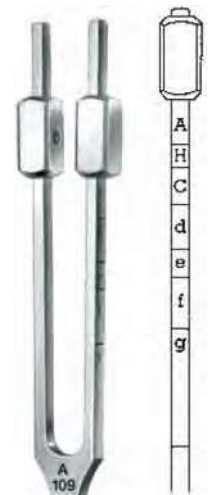

RYDEL-SEIFFERT
HMI-ENT-371
C 64/C 128

HMI-ENT-372 HMI-ENT-374

Damper white scale for 40-4224-10
Damper black scale for 40-4224-10

HMI-ENT-373 HMI-ENT-375

Knurled Screw for 40-4224-10
Weights, C 64 for 40-4224-10

HMI-ENT-376
C 64/C 128

KOENIG
HMI-ENT-377
A 109



HMI-ENT-378
Socket only

HARTMANN
HMI-ENT-379
C' 128



HARTMANN
HMI-ENT-380
C 128

40-1234-90
Bakelit base



HMI-ENT-381
d 440

Let Us know if you could not find what you are looking for

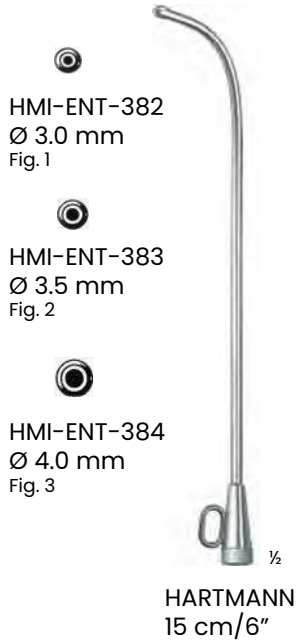

Let Us know if you could not find what you are looking for

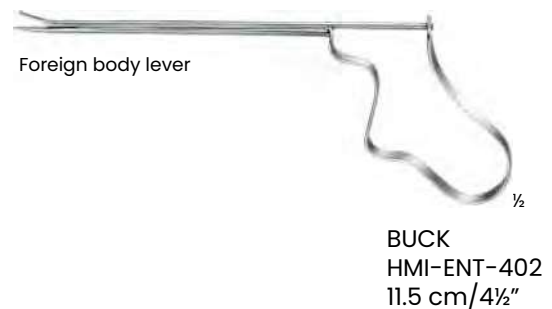
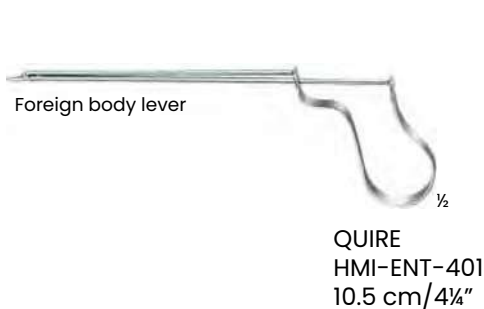
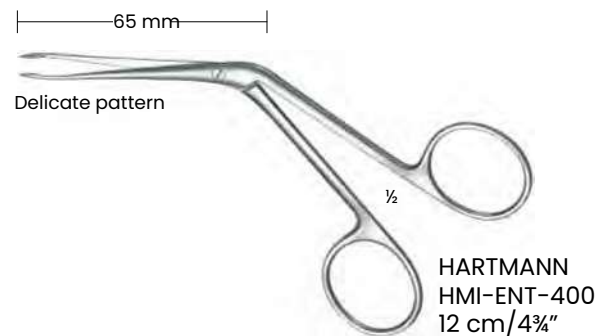
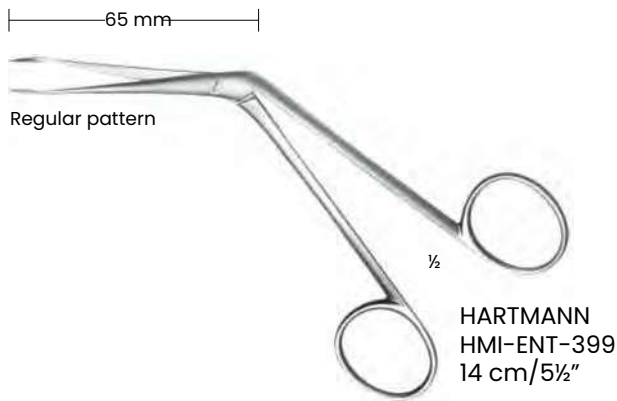
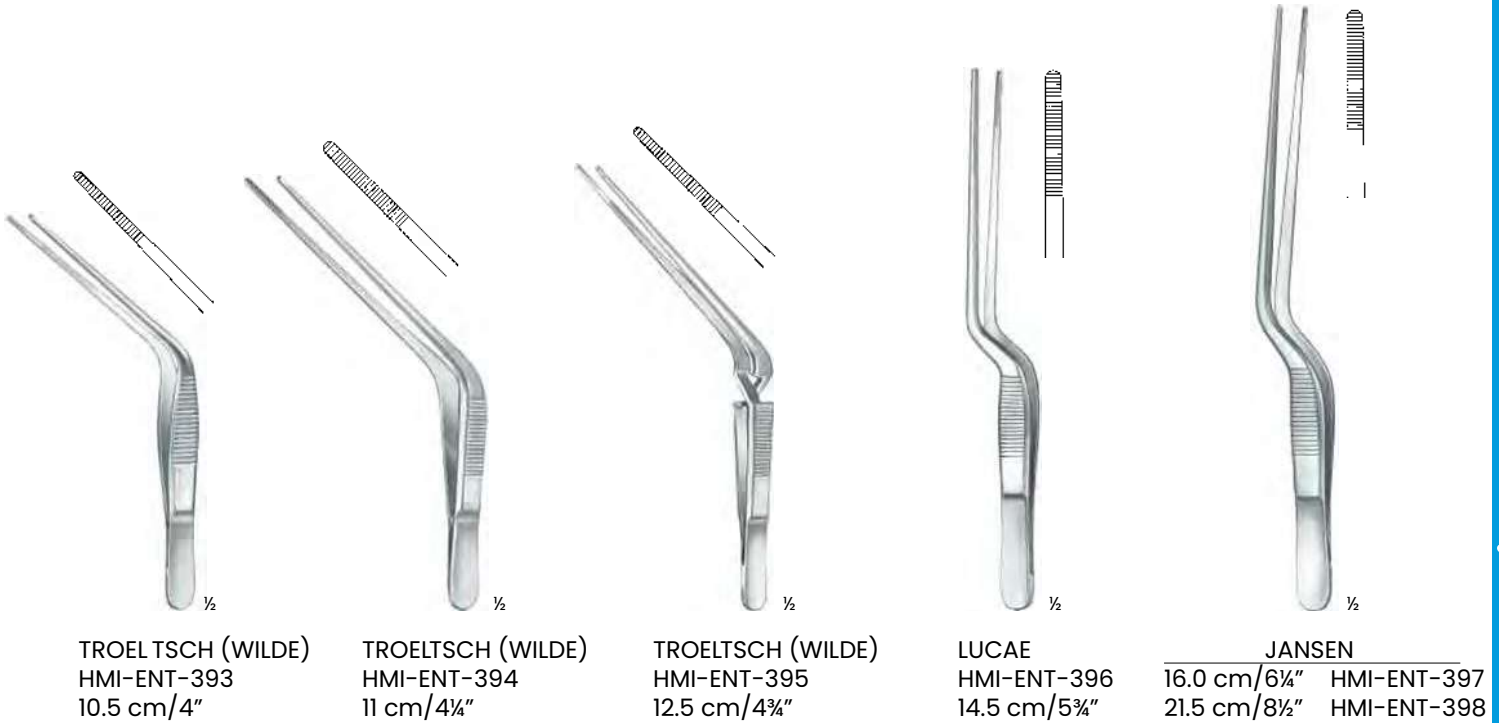

Let Us know if you could not find what you are looking for



GOLDSMITH-THUDICHUM
 6.5 cm/2½"

18.5 x 9.5 mm

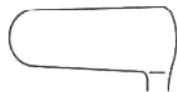

HMI-ENT-532
 Fig. 1

21.0 x 10.5 mm



HMI-ENT-533
 Fig. 2

21.0 x 11.5 mm



HMI-ENT-534
 Fig. 3



THUDICHUM (MARK HOVELL)

8.5 x 6.0 mm

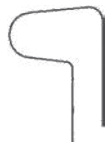

HMI-ENT-535
 70 mm

9.0 x 7.0 mm



HMI-ENT-536
 71 mm

12.5 x 8.0 mm

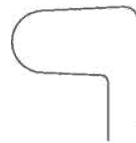

HMI-ENT-537
 72 mm

15.0 x 8.5 mm



HMI-ENT-538
 73 mm

16.5 x 9.0 mm

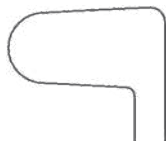

HMI-ENT-539
 74 mm

18.0 x 10.0 mm



HMI-ENT-540
 74 mm

19.5 x 10.6 mm

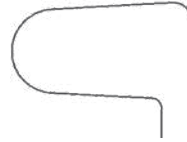

HMI-ENT-541
 75 mm

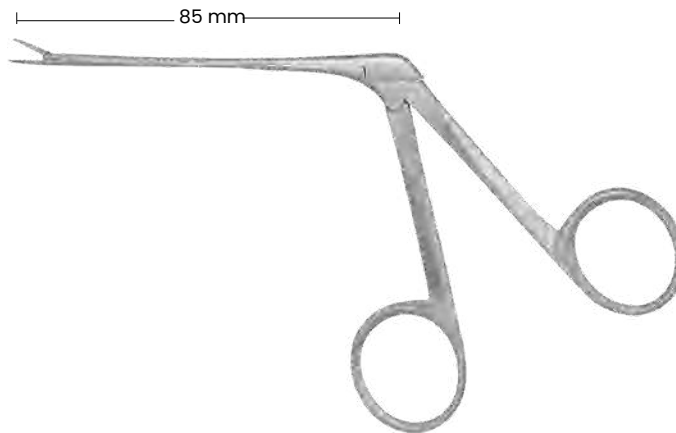

Serrated



HARTMANN-WULLSTEIN
 1.8 x 4.0 mm HMI-ENT-403
 1.8 x 8.0 mm HMI-ENT-404

Smooth



HARTMANN-WULLSTEIN
 1.8 x 8.0 mm HMI-ENT-405



HARTMANN-WULLSTEIN
 8.5 cm/3 1/2"
 Ø 1.0 mm HMI-ENT-406
 Ø 2.0 mm HMI-ENT-407
 Ø 2.5 mm HMI-ENT-408
 Ø 3.0 mm HMI-ENT-409

Serrated



HARTMANN
 8.5 cm/3 1/4" HMI-ENT-410
 14 cm/5 1/2" HMI-ENT-411
 16.5 cm/6 1/2" HMI-ENT-412

1:2



HARTMANN
 8.5 cm/3 1/2" HMI-ENT-413
 14 cm/5 1/2" HMI-ENT-414

Ø 3 mm



HARTMANN
 HMI-ENT-415
 8.5 cm/3 1/4"

Ø 2 mm



HARTMANN-HERZFELD
 HMI-ENT-416
 8.5 cm/3 1/4"

Ø 2.5 mm



HARTMANN-HERZFELD
 HMI-ENT-417
 8.5 cm/3 1/4"

Ø 3 mm



HARTMANN-HERZFELD
 HMI-ENT-418
 8.5 cm/3 1/4"

through cutting
 Ø 2 mm



HARTMANN-HOFFMANN
 HMI-ENT-419
 8.5 cm/3 1/4"



HARTMANN-NOYES
 Serrated HMI-ENT-420
 1x2 teeth HMI-ENT-421



STRÜMPEL
 HMI-ENT-422
 8.5 cm/3 1/4"

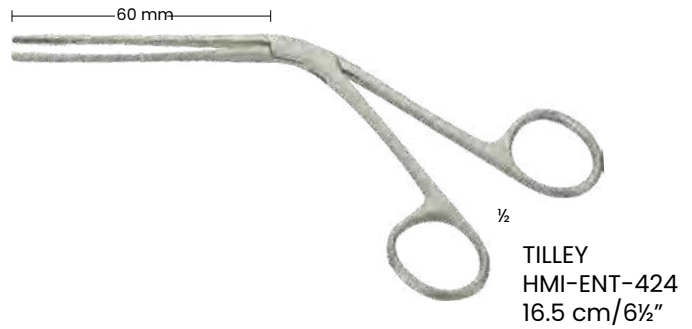
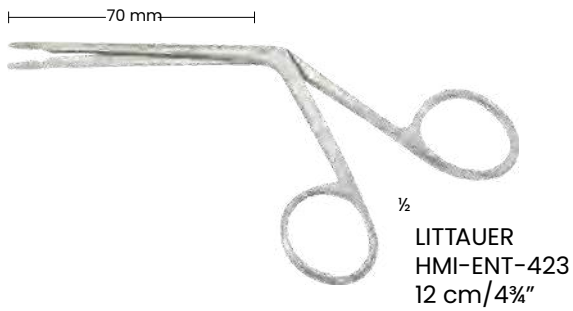

Mastoid Rongeurs

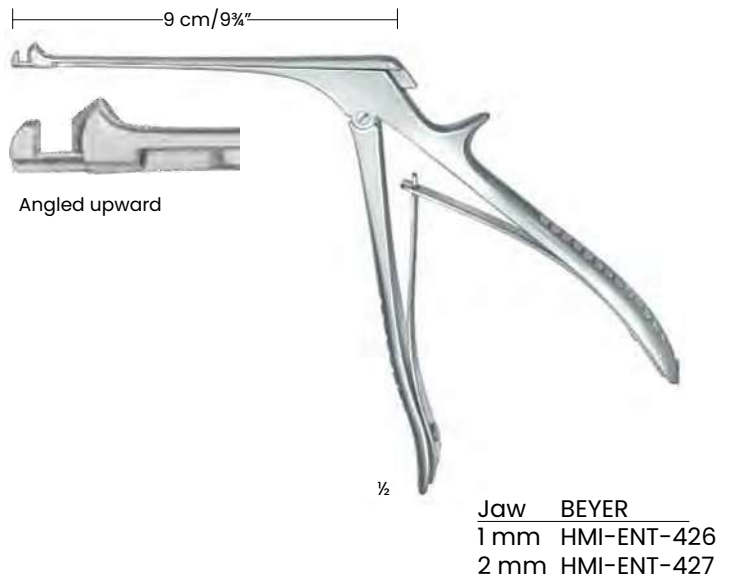

HMI-ENT-428
 3.5 x 3.5 mm

HMI-ENT-429
 4 x 4 mm

HMI-ENT-430
 4.5 x 4.5 mm

HMI-ENT-431
 5 x 5 mm

HMI-ENT-432
 6 x 6 mm

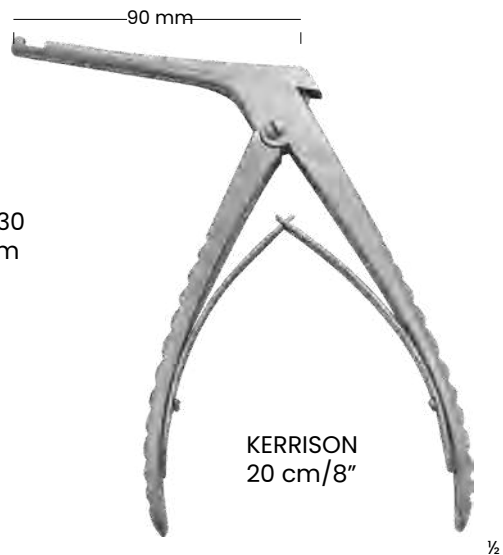

Valve Attachment



HMI-ENT-433

Suction Nozzle



HMI-ENT-434

Protecting Disc



HMI-ENT-435

Metal Olive



HMI-ENT-436

Conical tip



HMI-ENT-437

Button ended tip



HMI-ENT-438

Threaded tip



HMI-ENT-439



HMI-ENT-440

Flexible tube



HMI-ENT-441

Complete, self filling
in plastic pouch

HMI-ENT-442

Rubber gasket

HMI-ENT-443

Retention spring

HMI-ENT-444

Syringe, only
10 ml

Let Us know if you could not find what you are looking for

HMI-ENT-445

Complete ear syringe
with shield & 2 tips

Irrigation adapters



All metal syringe only Luer-Lock



SCHIMMELBUSCH

50 ml	HMI-ENT-446
75 ml	HMI-ENT-447
100 ml	HMI-ENT-448
150 ml	HMI-ENT-449
200 ml	HMI-ENT-450

SCHIMMELBUSCH

50 ml	HMI-ENT-500
75 ml	HMI-ENT-501
100 ml	HMI-ENT-502
150 ml	HMI-ENT-503
200 ml	HMI-ENT-504

Accessories for SCHIMMELBUSCH



HMI-ENT-505
Conical

HMI-ENT-506
Olive

HMI-ENT-507
Shield

HMI-ENT-508
Olive large

HMI-ENT-509
Conical small

HMI-ENT-510
Conical large

HMI-ENT-511
Olive bent

Let Us know if you could not find what you are looking for

Rhinology

- Adenoid Currettes
- Cartilage Crushers
- Chisels
- Elevators
- Osteotomes
- Gouges
- Nasal Cutting Forceps
- Nasal Dressing Forceps
- Nasal Knives
- Nasal Rasps
- Nasal Retractors
- Nasal Speculas
- Polypus Forceps
- Retractors
- Septum Forceps
- Skin Hooks



HARTMANN
 16.5 cm/6½"

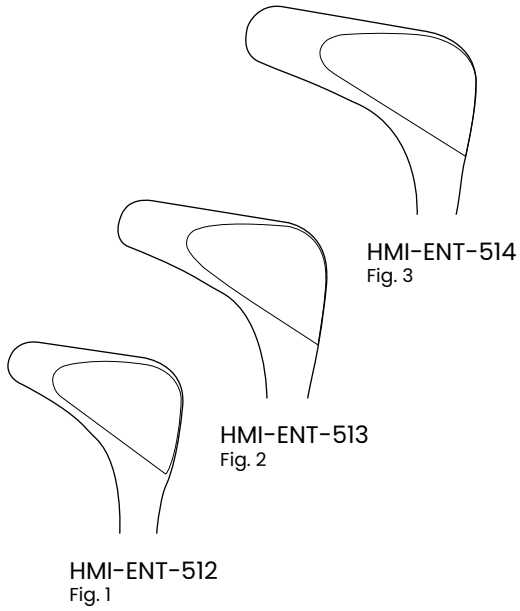

HMI-ENT-512
 Fig. 1

HMI-ENT-513
 Fig. 2

HMI-ENT-514
 Fig. 3



HARTMANN-HALLE
 14 cm/5½"

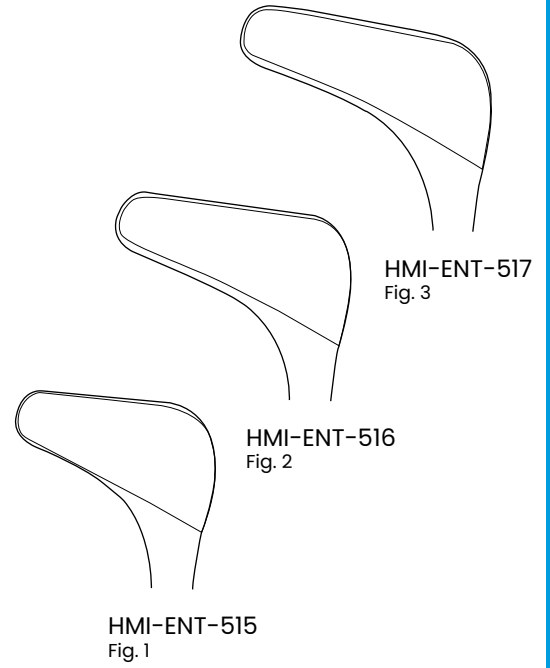

HMI-ENT-515
 Fig. 1

HMI-ENT-516
 Fig. 2

HMI-ENT-517
 Fig. 3



VIENNA
 14 cm/5½"

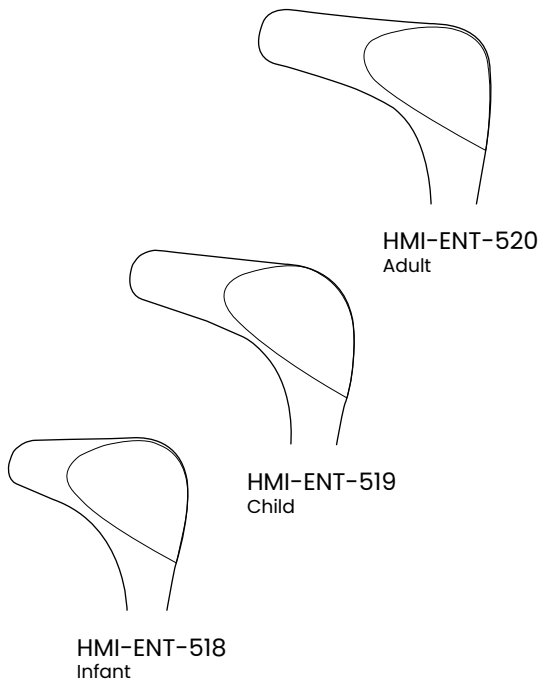

HMI-ENT-518
 Infant

HMI-ENT-519
 Child

HMI-ENT-520
 Adult



VIENNA
 HMI-ENT-521
 14 cm/5½"

light weight from
 sheet metal

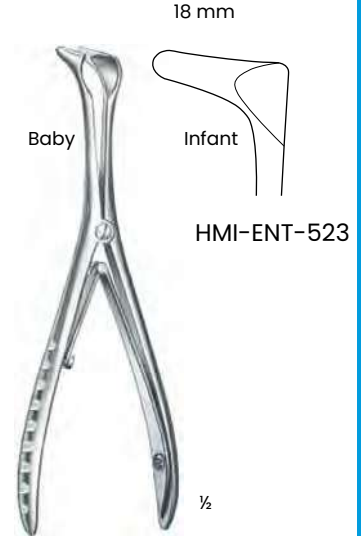

TIECK-HALLE
 HMI-ENT-522
 13 cm/5"

18 mm

Baby

Infant

HMI-ENT-523

Let Us know if you could not find what you are looking for



KILLIAN
 14 cm / 5½"

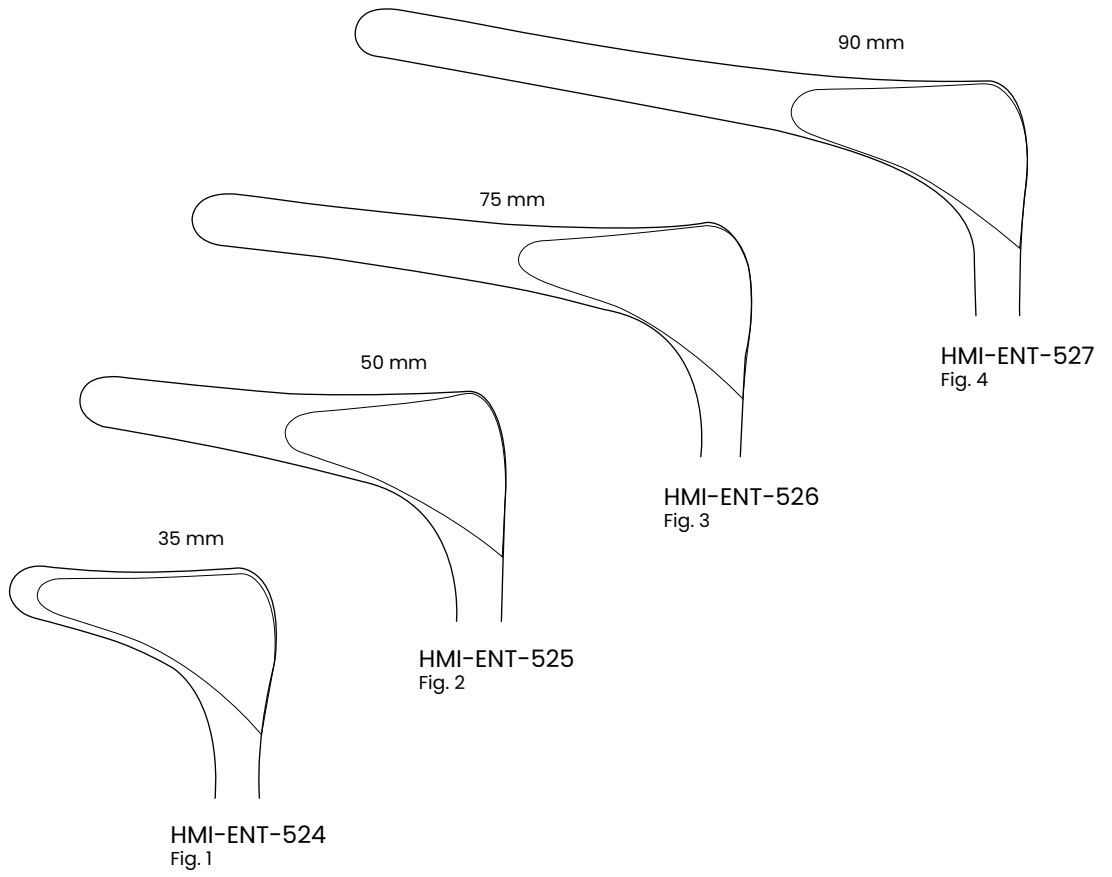

HMI-ENT-524
 Fig. 1

HMI-ENT-525
 Fig. 2

HMI-ENT-526
 Fig. 3

HMI-ENT-527
 Fig. 4



COTTLE
 15 cm / 6"

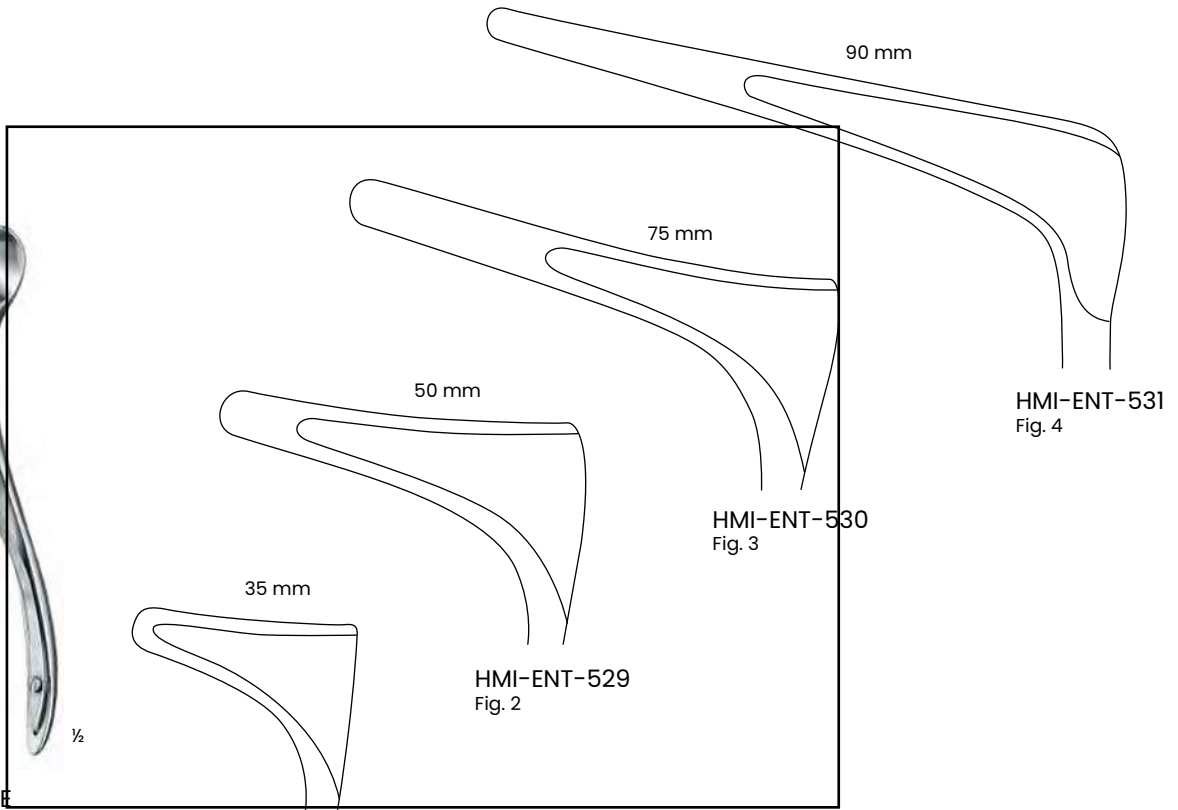

HMI-ENT-528
 Fig. 1

HMI-ENT-529
 Fig. 2

HMI-ENT-530
 Fig. 3

HMI-ENT-531
 Fig. 4

Let Us know if you could not find what you are looking for

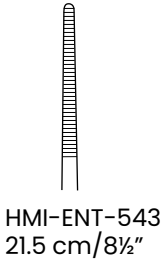
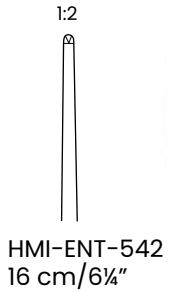

GRUENWALD (JANSEN)



TROELTSCH
 HMI-ENT-544
 14.5 cm/5 3/4"



TROELTSCH
 HMI-ENT-545
 15.5 cm/6"



TROELTSCH
 15 cm/6" HMI-ENT-546
 18 cm/7" HMI-ENT-547



WESTMACOTT
 HMI-ENT-548
 20 cm/8"



LUBET-BARBON
 HMI-ENT-549
 18.5 cm/7 1/4"



HARTMANN
 HMI-ENT-550
 18.5 cm/7 1/4"

Nasal polypus forceps

Let Us know if you could not find what you are looking for



KNIGHT
HMI-ENT-551
17 cm/6¾"



GRAIG
HMI-ENT-552
16 cm/6¼"

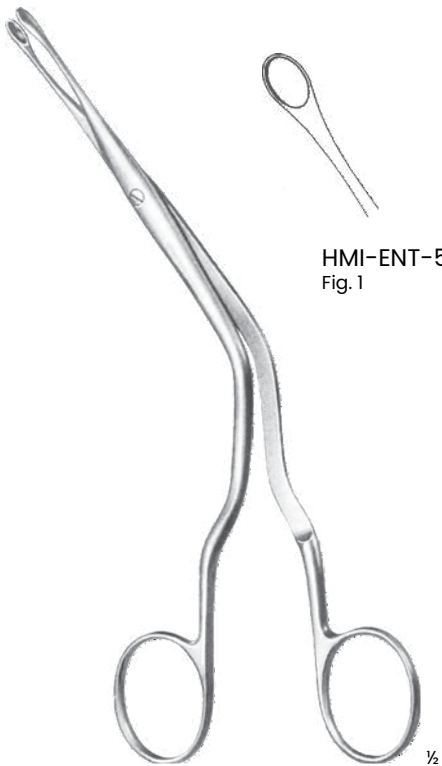
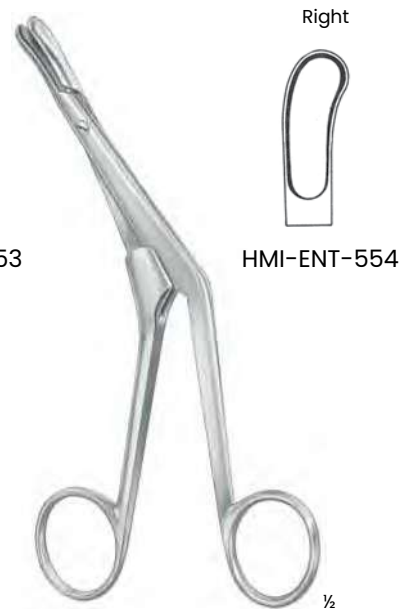

LUC
20 cm/8"

HMI-ENT-555
Fig. 1

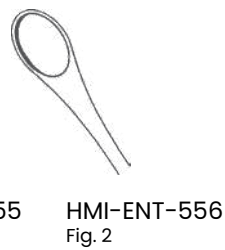

BRUENINGS
16.5 cm/6½"



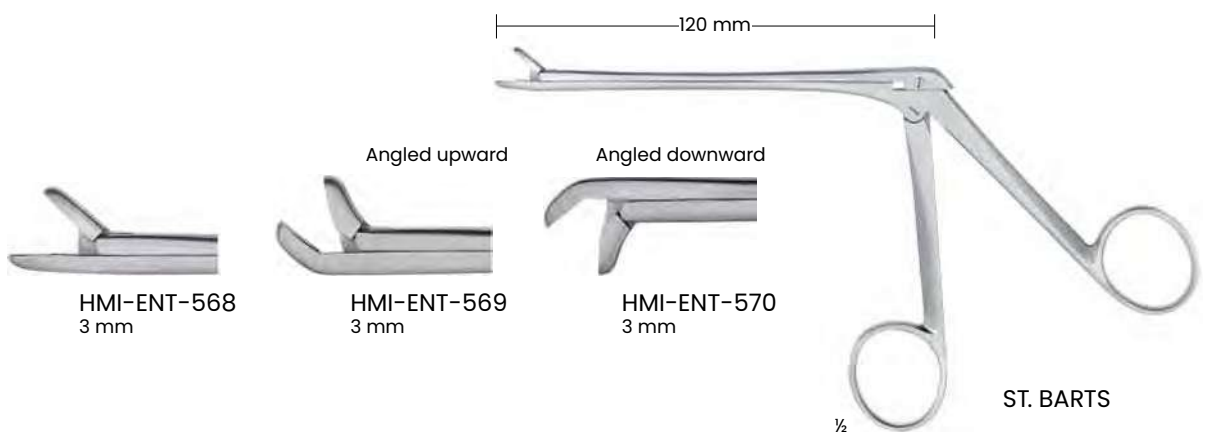
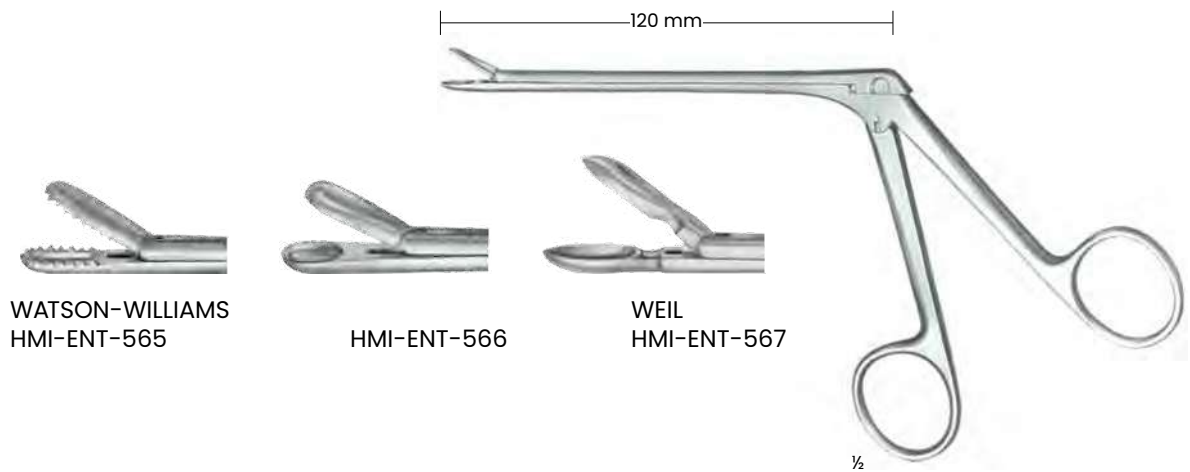
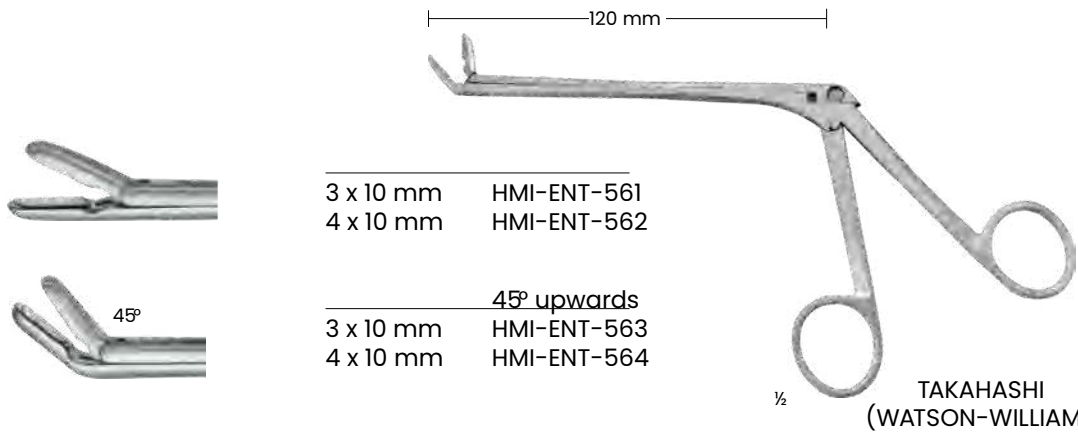

Let Us know if you could not find what you are looking for

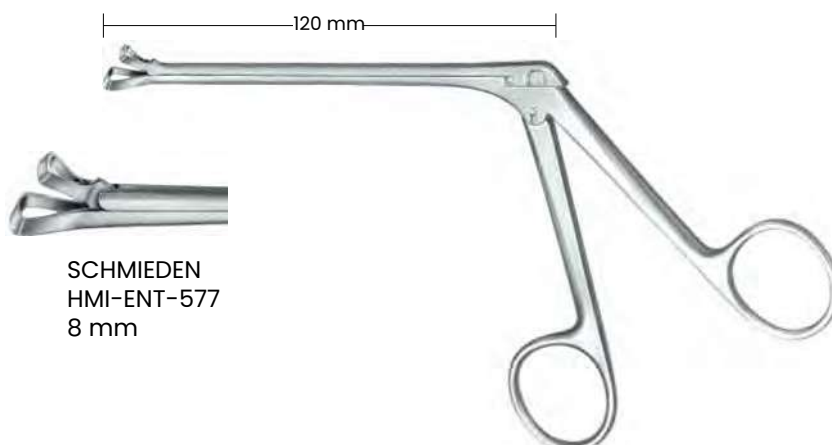
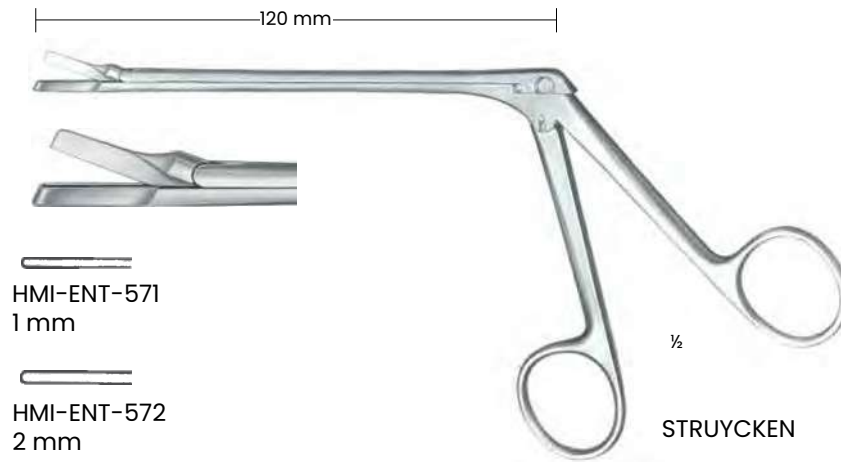

Nasal Cutting Forceps

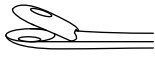

HMI-ENT-578
3 mm
Fig.1



HMI-ENT-579
3.5 mm
Fig.2



HMI-ENT-580
4.5 mm
Fig.3



HMI-ENT-581
5.5 mm
Fig.4



HMI-ENT-582
6 mm
Fig.5



45°



HMI-ENT-583
3 mm
Fig.1



HMI-ENT-584
3.5 mm
Fig.2



HMI-ENT-585
4.5 mm
Fig.3



HMI-ENT-586
5.5 mm
Fig.4



HMI-ENT-587
6 mm
Fig.5



90°



HMI-ENT-588
3 mm
Fig.1



HMI-ENT-589
3.5 mm
Fig.2



HMI-ENT-590
4.5 mm
Fig.3



HMI-ENT-591
5.5 mm
Fig.4



HMI-ENT-592
6 mm
Fig.5

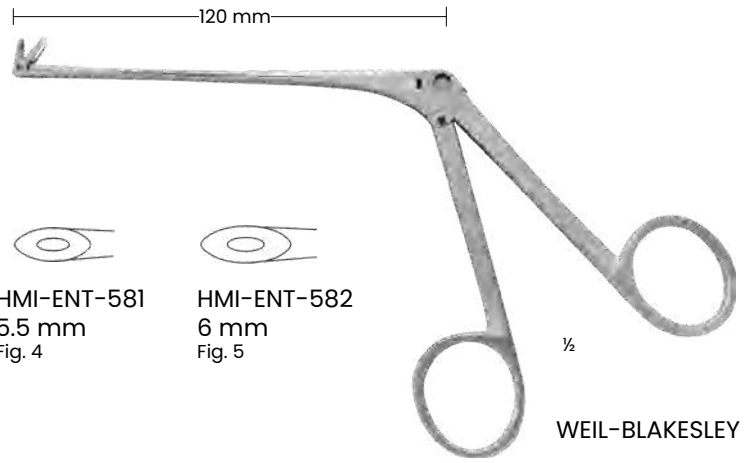

1/2

WEIL-BLAKESLEY

Nasal Through Cutting Forceps

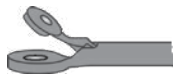

HMI-ENT-593
3 mm
Fig.1



HMI-ENT-594
3.5 mm
Fig.2



HMI-ENT-595
4.5 mm
Fig.3



HMI-ENT-596
5.5 mm
Fig.4



HMI-ENT-597
6 mm
Fig.5



45°



HMI-ENT-598
3 mm
Fig.1



HMI-ENT-599
3.5 mm
Fig.2



HMI-ENT-600
4.5 mm
Fig.3



HMI-ENT-601
5.5 mm
Fig.4



HMI-ENT-602
6 mm
Fig.5

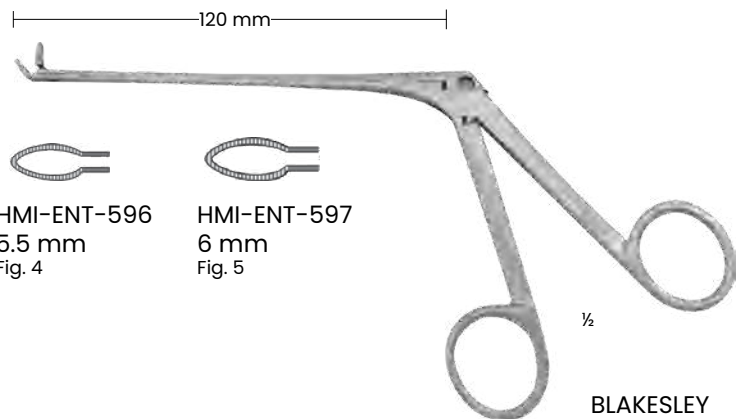

1/2

BLAKESLEY

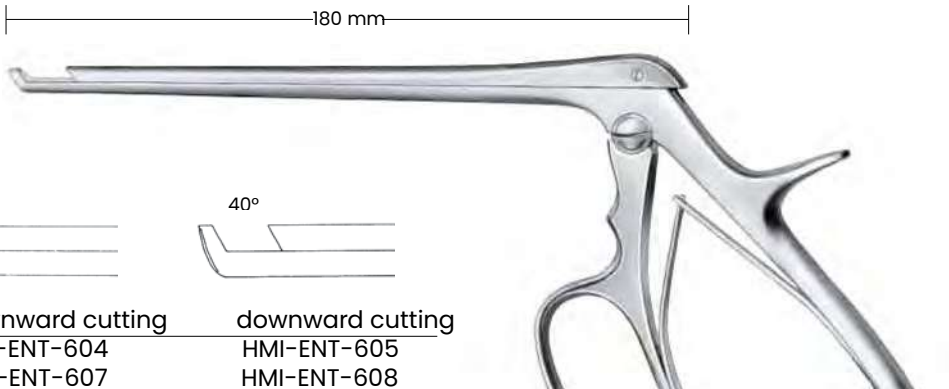

180 mm

90° 90° 40°

	upward cutting	downward cutting	downward cutting
3 mm	HMI-ENT-603	HMI-ENT-604	HMI-ENT-605
5 mm	HMI-ENT-606	HMI-ENT-607	HMI-ENT-608

½
FERRIS-SMITH-KERRISON

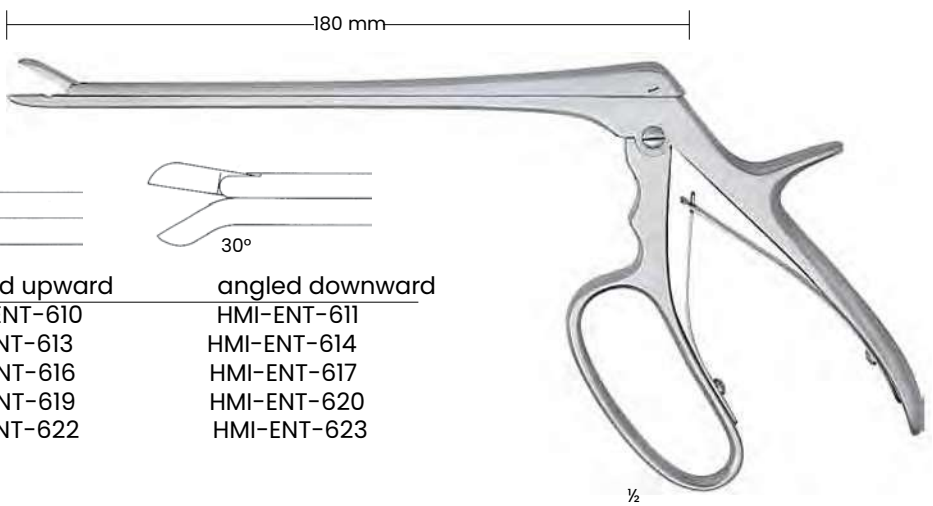

180 mm

straight angled upward angled downward

2 x 10 mm	HMI-ENT-609	HMI-ENT-610	HMI-ENT-611
3 x 10 mm	HMI-ENT-612	HMI-ENT-613	HMI-ENT-614
4 x 10 mm	HMI-ENT-615	HMI-ENT-616	HMI-ENT-617
5 x 10 mm	HMI-ENT-618	HMI-ENT-619	HMI-ENT-620
6 x 10 mm	HMI-ENT-621	HMI-ENT-622	HMI-ENT-623

30°

½

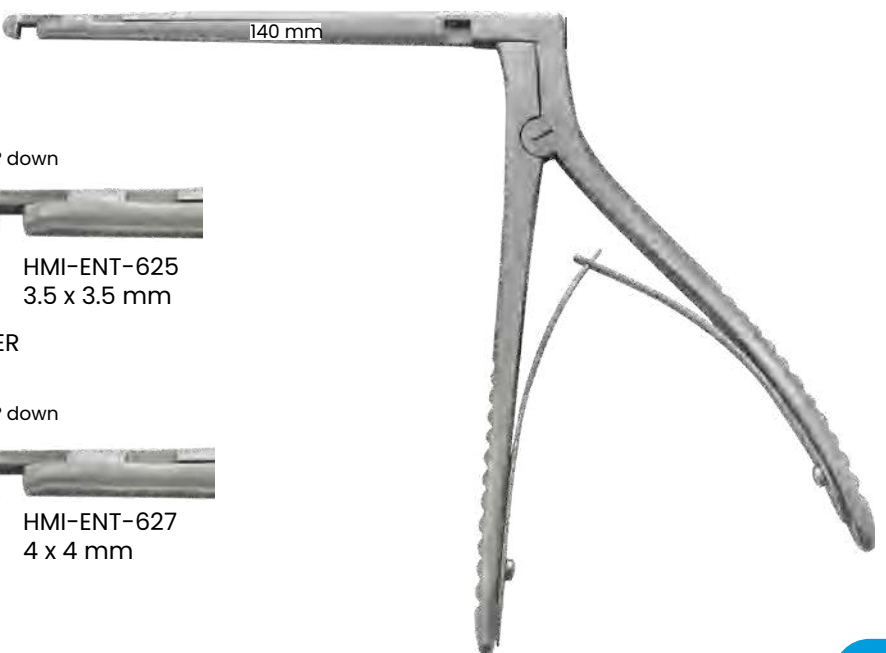

140 mm

90° up 90° down

HMI-ENT-624 HMI-ENT-625
 3.5 x 3.5 mm 3.5 x 3.5 mm

HAJEK-KOFLER

90° up 90° down

HMI-ENT-626 HMI-ENT-627
 4 x 4 mm 4 x 4 mm

HAJEK

Let Us know if you could not find what you are looking for



KRAUSE
HMI-ENT-628
26 cm/10¼"



KRAUSE-VOSS
HMI-ENT-629
26 cm/10¼"



Septum Forceps,
 Septum Morselizers

Through-cutting

TC Jaws



1/2
 MIDDLETON-JANSEN
 20.5 cm/8 1/4"
 4 x 20 mm HMI-ENT-633
 5 x 24 mm HMI-ENT-634

1/2
 MIDDLETON-JANSEN
 HMI-ENT-635
 20 cm/8"

1/2
HMI-ENT-636
 20 cm/8"



Protection Cap



RUBIN
 HMI-ENT-640

RUBIN
 HMI-ENT-637 1/2
 20 cm/8"

RUBIN
 HMI-ENT-638 1/2
 18.5 cm/7 1/4"

RUBIN
HMI-ENT-639 1/2
 18.5 cm/7 1/4"

One toothed cutting edge

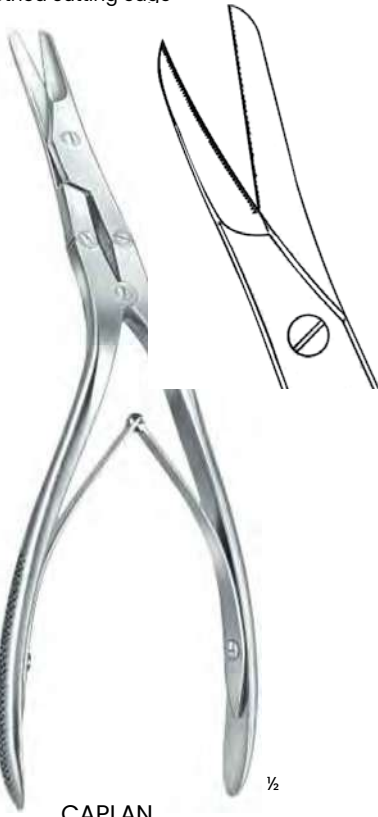

CAPLAN
HMI-ENT-641
20 cm/8"

Longitudinal Jaw

TC Jaws

Morselizer Jaw

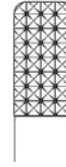

HMI-ENT-642

HMI-ENT-643

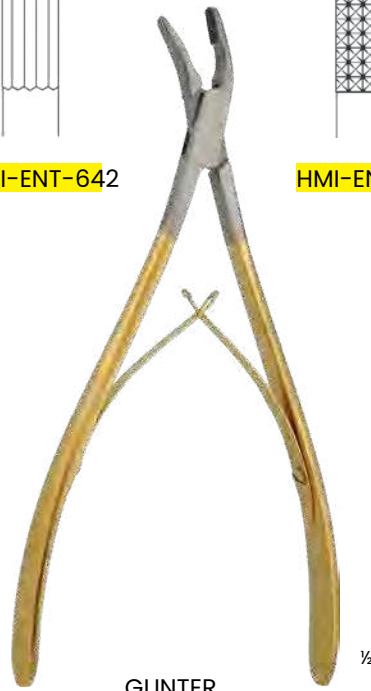

GUNTER
18 cm/7"

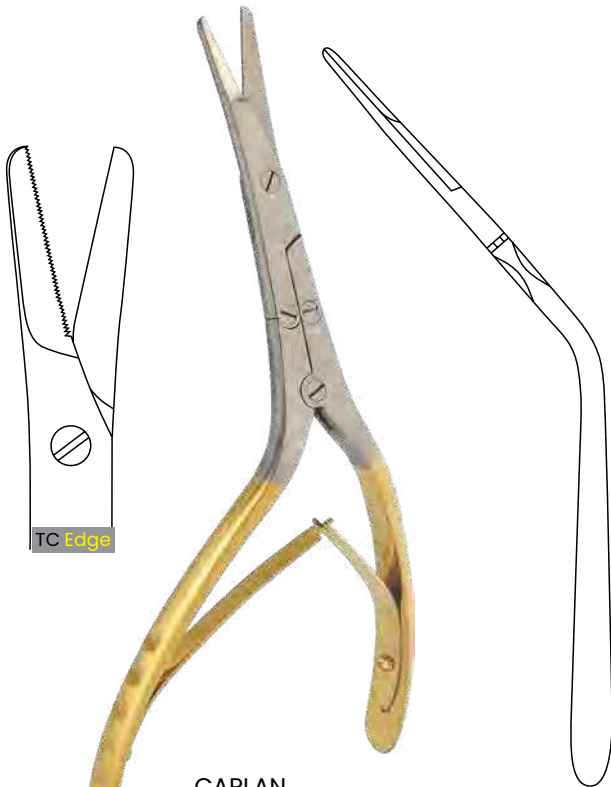

CAPLAN
HMI-ENT-644
21 cm/8 1/4"

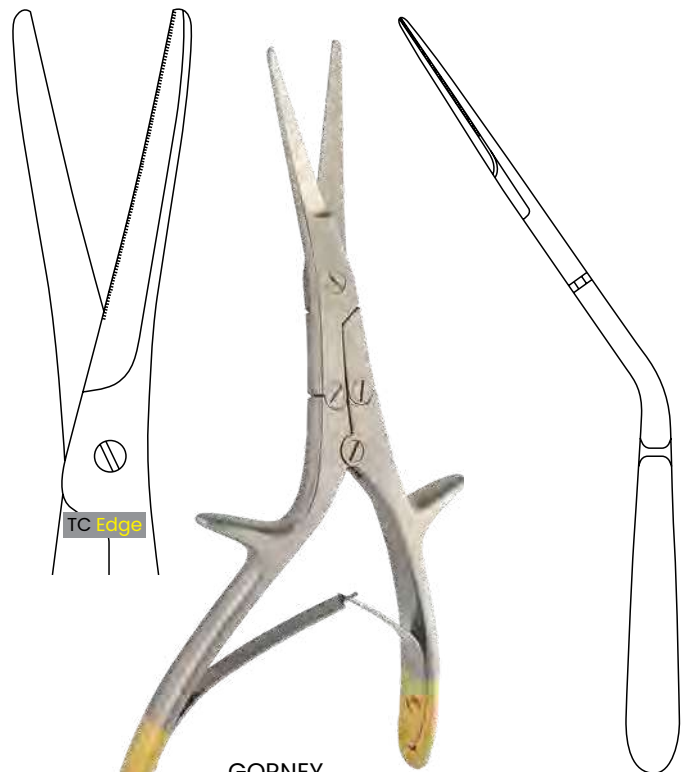

GORNEY
HMI-ENT-645
20.5 cm/8"

Let Us know if you could not find what you are looking for



Let Us know if you could not find what you are looking for

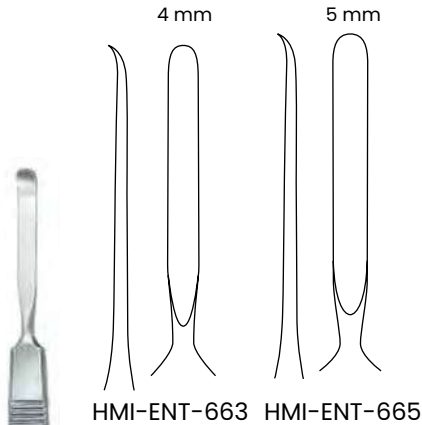

MCKENTY
 15 cm/6"



HALLE
 HMI-ENT-666
 16 cm/6¼"



COTTLE
 HMI-ENT-667
 19 cm/7½"



JOSEPH
 HMI-ENT-668
 16.5 cm/6½"

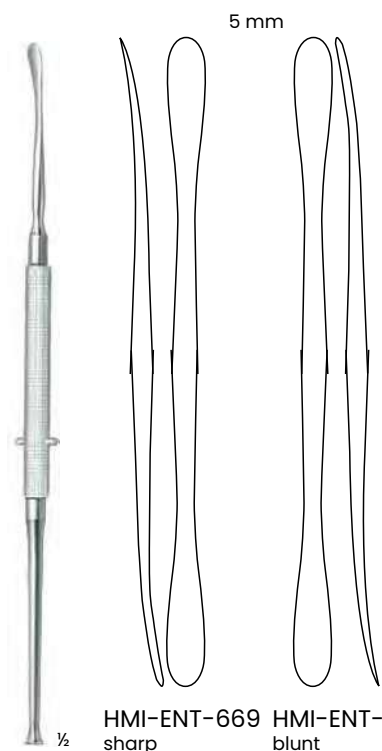

FREER
 19 cm/7½"

HMI-ENT-669 sharp
 HMI-ENT-670 blunt

Cleft Palate Periosteal Rasapatory

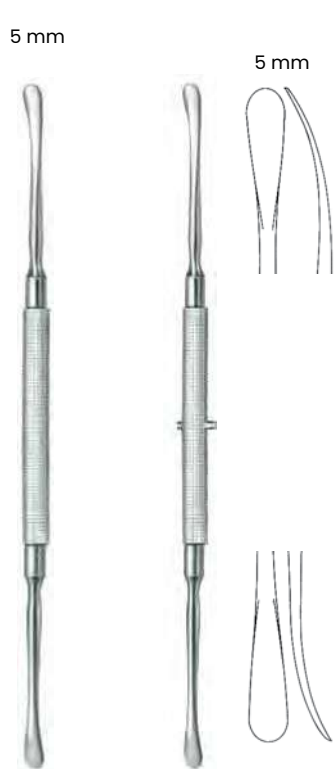

FREER ½
 HMI-ENT-671
 18 cm/7"

FREER ½
 HMI-ENT-672
 18 cm/7"

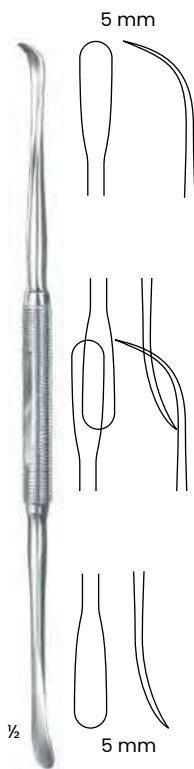

FREER ½
 HMI-ENT-673
 21 cm/8¼"

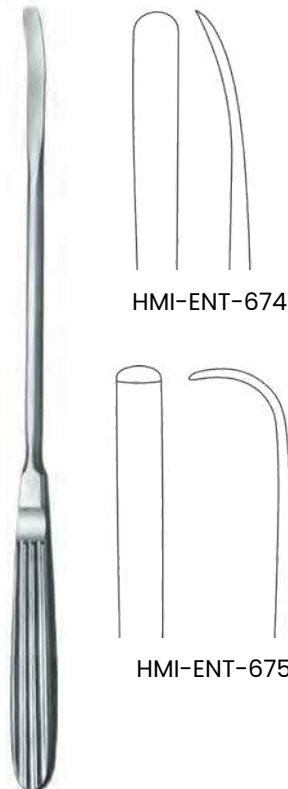

KRENKEL ½
 24.5 cm/9½"

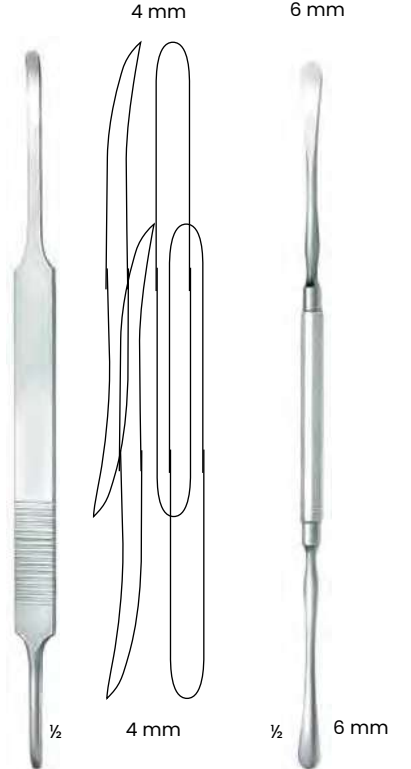

MCKENTY
 HMI-ENT-676
 20.5 cm/8"

BALLENGER-HAJEK
 HMI-ENT-677
 19 cm/7½"

Let Us know if you could not find what you are looking for

**Septum Elevators,
 Periosteal Elevators**

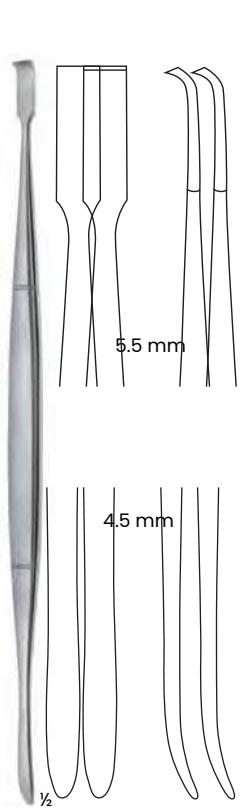

HOWARD
 HMI-ENT-678
 21.5 cm/8½"

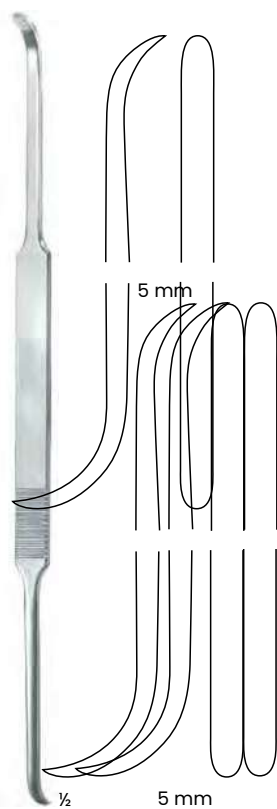

COTTLE
 HMI-ENT-679
 23.5 cm/9¼"



KILLIAN
 HMI-ENT-680
 18 cm/7"



KILLIAN
 HMI-ENT-681
 23.5 cm/9¼"

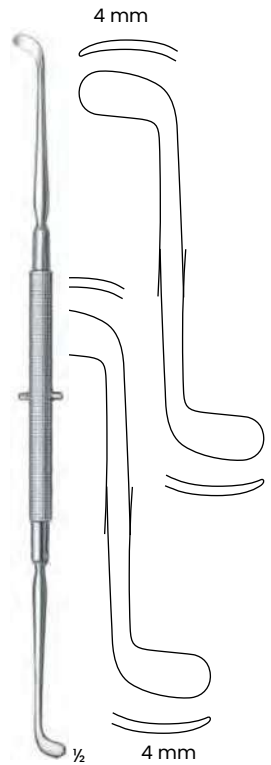

PENNINGTON
 HMI-ENT-682
 21 cm/8"



ROGER
 HMI-ENT-683
 19 cm/7½"



JOSEPH-MASING
 HMI-ENT-684
 21.5 cm/8½"

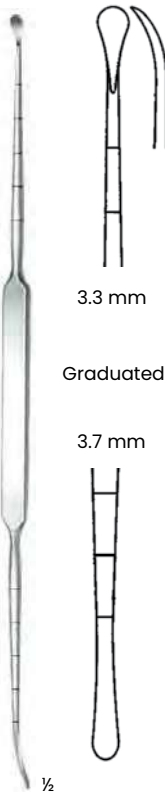

COTTLE
 HMI-ENT-685
 23 cm/9"

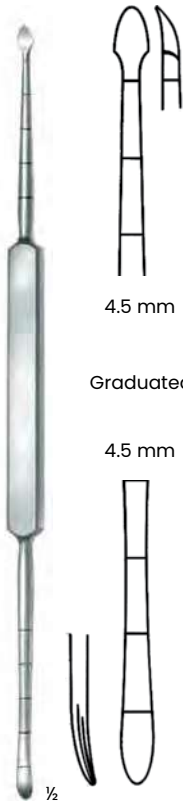

COTTLE
 HMI-ENT-686
 23 cm/9"



JOSEPH
 HMI-ENT-687
 18 cm/7"

Let Us know if you could not find what you are looking for



FREER
 HMI-ENT-688
 16.5 cm/6½"



FREER
 HMI-ENT-689
 16 cm/6¼"



KILLIAN-CLAUS
 HMI-ENT-690
 16 cm/6¼"



KILLIAN
 HMI-ENT-691
 16 cm/6¼"



BALLENGER
 15 cm/6"

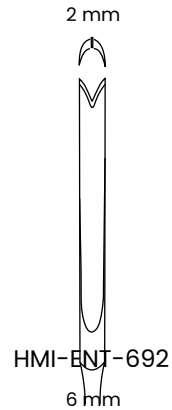

HMI-ENT-692
 6 mm

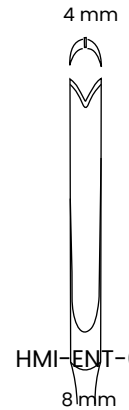

HMI-ENT-693
 8 mm

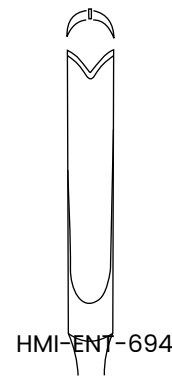

HMI-ENT-694
 6 mm

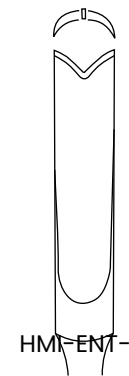

HMI-ENT-695
 6 mm

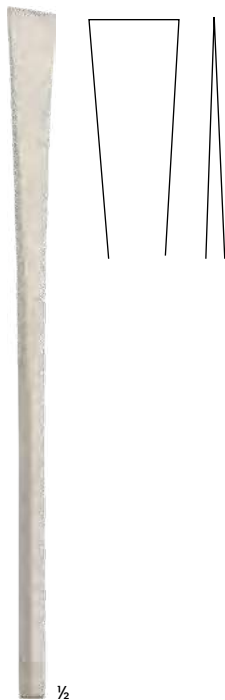

SHEEHAN
 16 cm/6¼"

2 mm	HMI-ENT-6969 mm	HMI-ENT-703
3 mm	HMI-ENT-69710 mm	HMI-ENT-704
4 mm	HMI-ENT-69811 mm	HMI-ENT-705
5 mm	HMI-ENT-69912 mm	HMI-ENT-706
6 mm	HMI-ENT-70013 mm	HMI-ENT-707
7 mm	HMI-ENT-701 14 mm	HMI-ENT-708
8 mm	HMI-ENT-702 15 mm	HMI-ENT-709



RUBIN
 18.5 cm/7¼"

6 mm	HMI-ENT-710
8 mm	HMI-ENT-711
10 mm	HMI-ENT-712
11 mm	HMI-ENT-713
12 mm	HMI-ENT-714
14 mm	HMI-ENT-715
16 mm	HMI-ENT-716



COTTLE
 18.5 cm/7¼"

2 mm	HMI-ENT-717
4 mm	HMI-ENT-718
6 mm	HMI-ENT-719
7 mm	HMI-ENT-720
8 mm	HMI-ENT-721
9 mm	HMI-ENT-722
10 mm	HMI-ENT-723
12 mm	HMI-ENT-724



COTTLE
 HMI-ENT-725
 18.5 cm/7¼"

Let Us know if you could not find what you are looking for



COTTLE
HMI-ENT-726
18.5 cm/7¼"



COTTLE
HMI-ENT-727
18.5 cm/7¼"



COTTLE
HMI-ENT-728
18.5 cm/7¼"



HMI-ENT-729
3 mm

WALTER
19 cm/7½"



HMI-ENT-730
4.5 mm

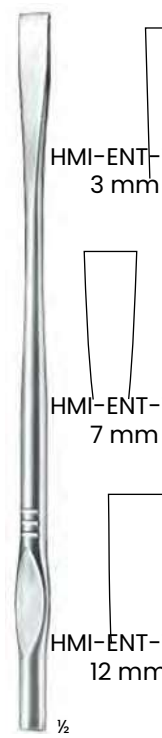

HMI-ENT-731
3 mm

WALTER
19 cm/7½"

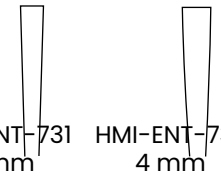

HMI-ENT-734
4 mm

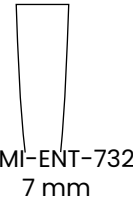

HMI-ENT-732
7 mm

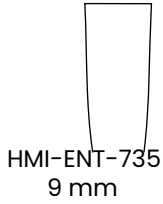

HMI-ENT-735
9 mm



HMI-ENT-733
12 mm



COTTLE
18.5 cm/7¼"

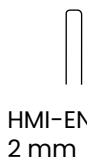

HMI-ENT-737
4 mm



HMI-ENT-738
7 mm



HMI-ENT-740
12 mm



HMI-ENT-741
4 mm



HMI-ENT-743
6 mm

FOMON
16 cm/6¼"

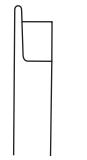

HMI-ENT-742
5 mm

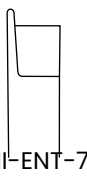

HMI-ENT-744
7 mm

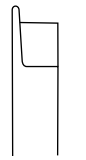

HMI-ENT-745
10 mm



HMI-ENT-746
14 mm

CINELLI
16 cm/6¼"

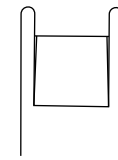

HMI-ENT-747
12 mm

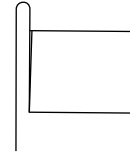

HMI-ENT-748
16 mm

Let Us know if you could not find what you are looking for

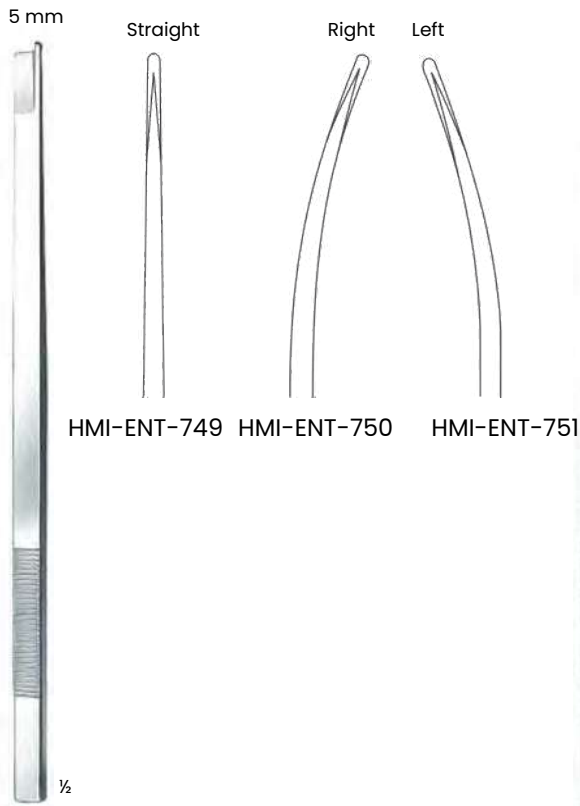

NEIVERT-ANDERSON
20.5 cm/8"



SILVER
18 cm/7"

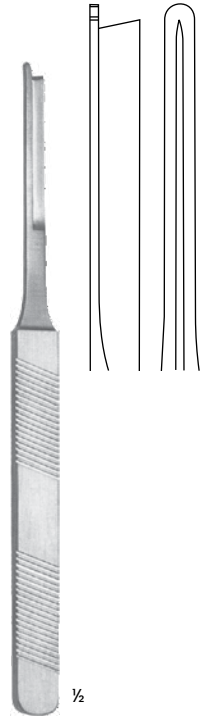

PARKES
HMI-ENT-755
18 cm/7"

Nasal Saws



JOSEPH

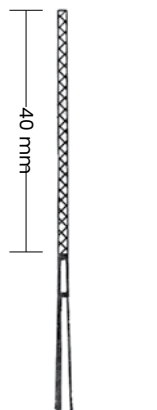

HMI-ENT-756
19 cm/7 1/2"

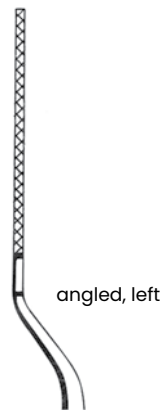

HMI-ENT-757
19 cm/7 1/2"



HMI-ENT-758
19 cm/7 1/2"

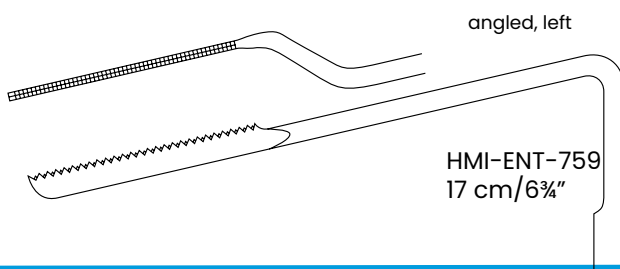

HMI-ENT-759
17 cm/6 3/4"

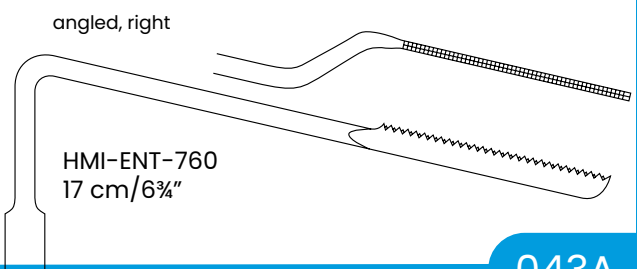

HMI-ENT-760
17 cm/6 3/4"

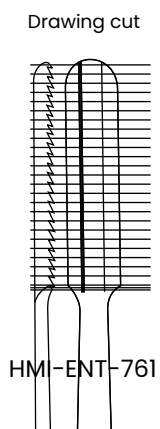

MALTZ
17 cm/6¾"

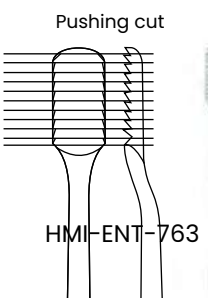
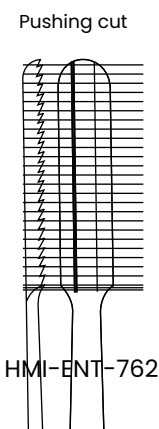

LEWIS
19 cm/7½"

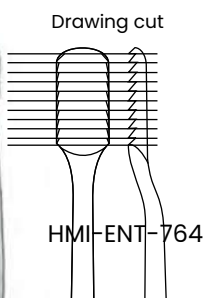

GALLAHER
17 cm/6¾"



HMI-ENT-765

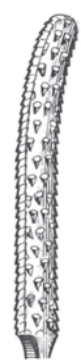

HMI-ENT-766



HMI-ENT-767

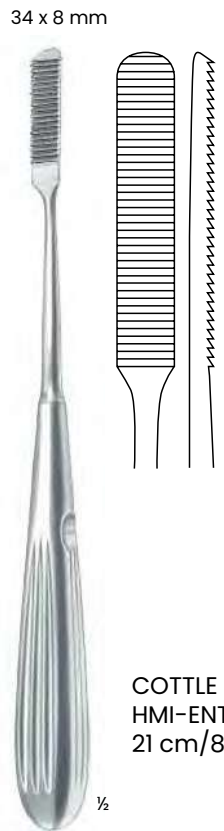

COTTLE
HMI-ENT-768
21 cm/8¼"

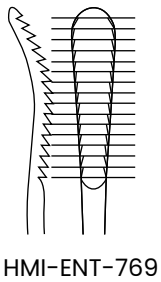

AUFRICHT
21 cm/8¼"



AUFRICHT (GLABELLA)
20 cm/8"

Downward Upward
4 mm HMI-ENT-771 HMI-ENT-773
7 mm HMI-ENT-772 HMI-ENT-774

TC Jaws



AUFRICHT (GLABELLA)
HMI-ENT-775
21 cm/8¼"

Let Us know if you could not find what you are looking for

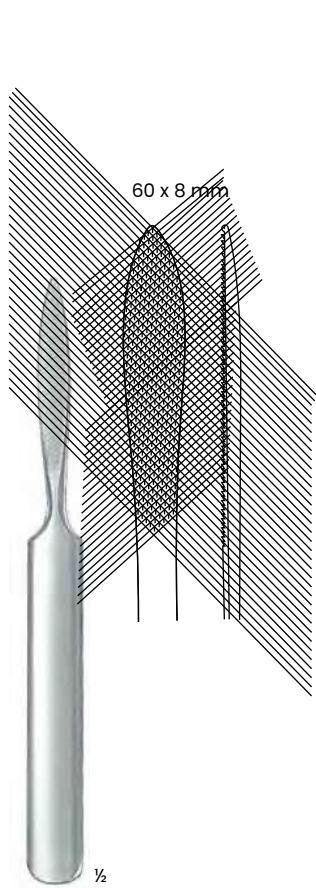

JOSEPH
 HMI-ENT-776
 16 cm / 6 1/4"

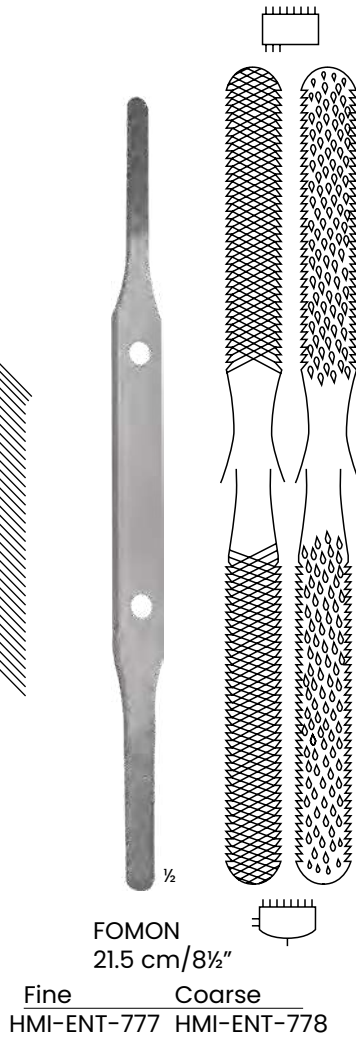

FOMON
 21.5 cm / 8 1/2"
 Fine HMI-ENT-777 Coarse HMI-ENT-778

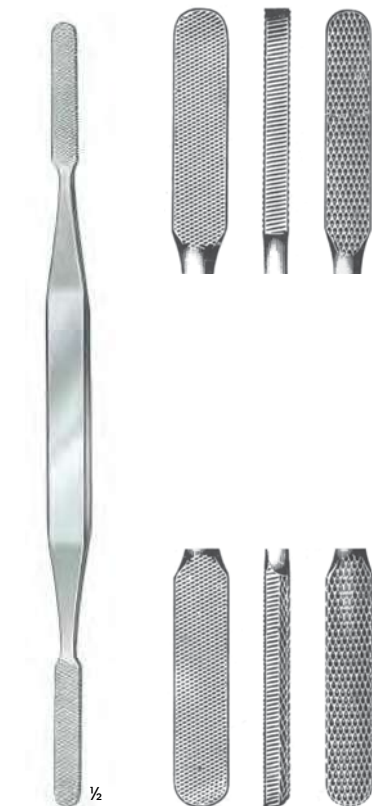

FOMON
 HMI-ENT-779
 20.5 cm / 8"

Guide Support for osteotomes



COTTLE
 Smooth Bed HMI-ENT-780
 Serrated Bed HMI-ENT-781



TOLSDORF
 Smooth Bed HMI-ENT-782
 Serrated Bed HMI-ENT-783



COTTLE
 HMI-ENT-784
 7 mm



COTTLE
 HMI-ENT-785
 12 cm / 4 3/4"

Let Us know if you could not find what you are looking for

TC Jaws



FOMON $\frac{1}{2}$
 20 cm/8"

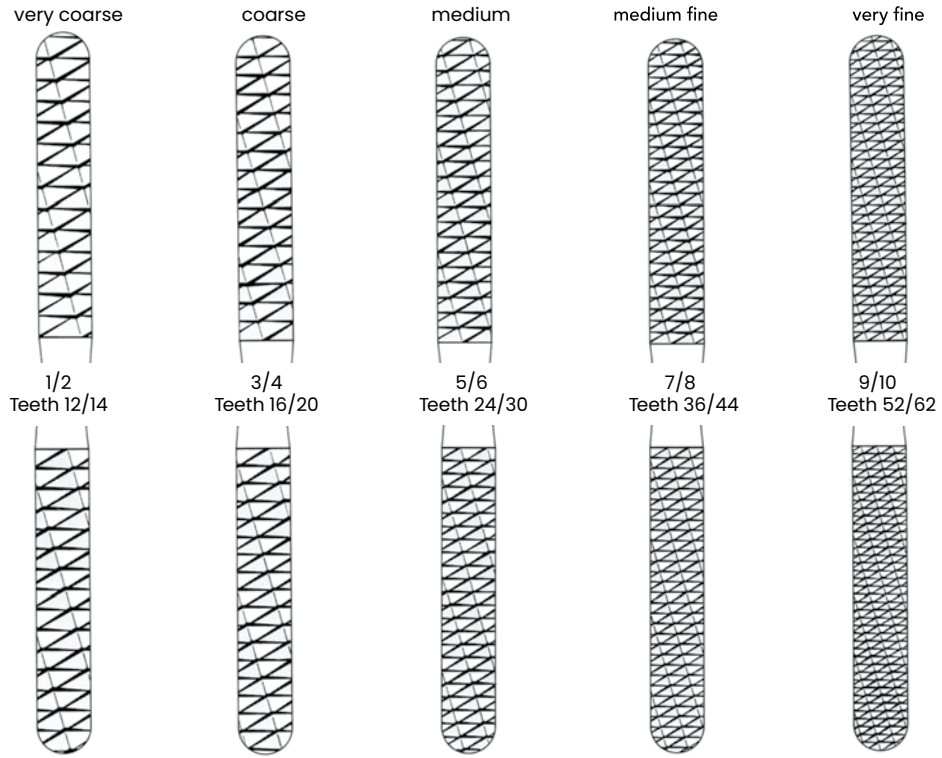

HMI-ENT-786 HMI-ENT-787 HMI-ENT-788 HMI-ENT-789 HMI-ENT-790

TC Jaws



PARKES $\frac{1}{2}$
 21 cm/8 1/4"

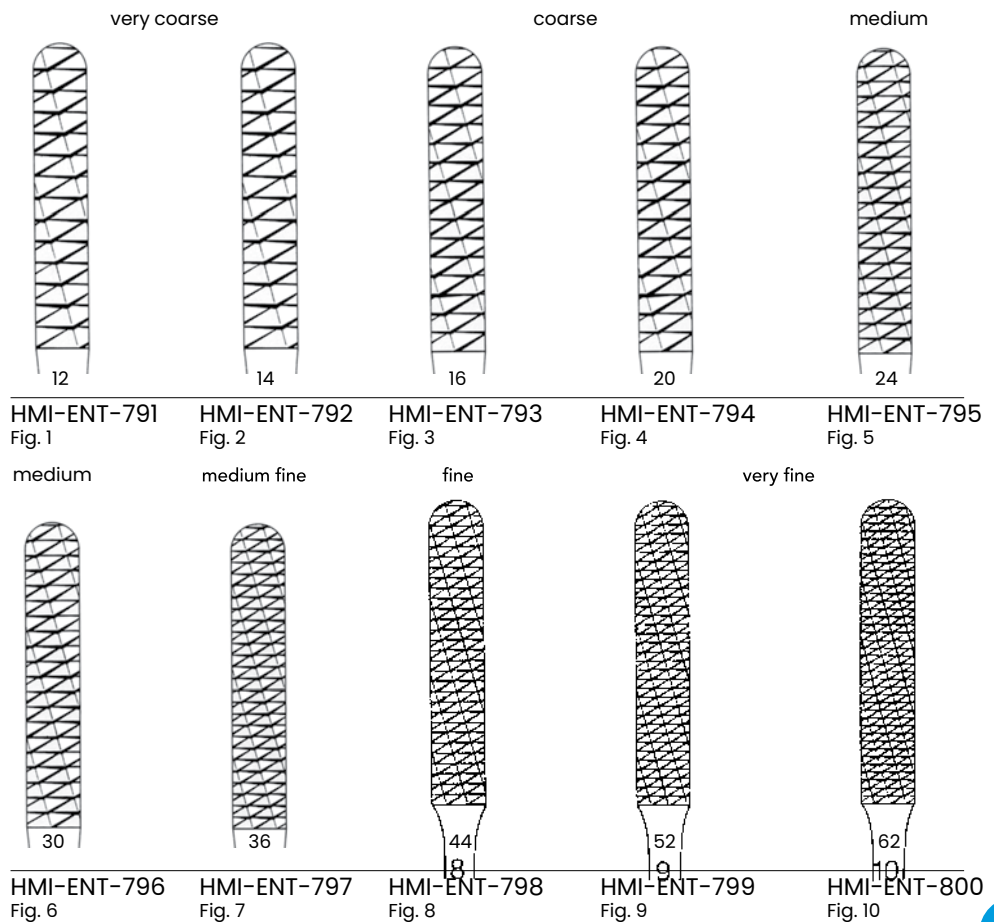

Let Us know if you could not find what you are looking for



COTTLE-NEIVERT
HMI-ENT-821
19.5 cm/7¾"

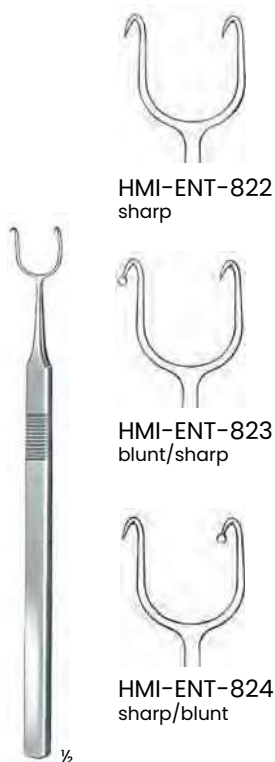

HMI-ENT-822
sharp

HMI-ENT-823
blunt/sharp

HMI-ENT-824
sharp/blunt

COTTLE
19.5 cm/7¾"

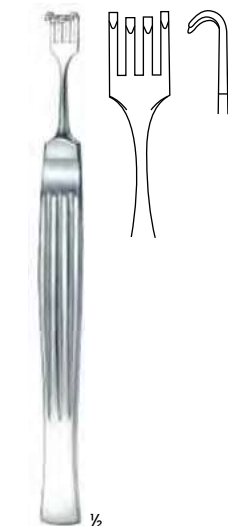

COTTLE
HMI-ENT-825
14 cm/5½"



NEIVERT
HMI-ENT-826
17 cm/6¾"

Saddle Hook



COTTLE
HMI-ENT-827
14 cm/5½"

COTTLE
HMI-ENT-828
16 cm/6¼"



AUFRICHT
HMI-ENT-829
12 cm/4¾"



OGURA
HMI-ENT-830
11 cm/4¼"



COTTLE
HMI-ENT-831
14 cm/5½"

Columella Forceps
12 mm



COTTLE
HMI-ENT-832
11 cm/4¼"



COAKLEY
17 cm/6¾"

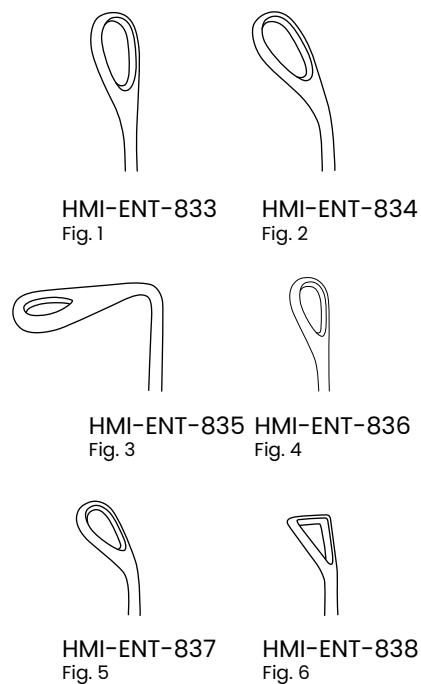

HMI-ENT-833
Fig. 1

HMI-ENT-834
Fig. 2

HMI-ENT-835
Fig. 3

HMI-ENT-836
Fig. 4

HMI-ENT-837
Fig. 5

HMI-ENT-838
Fig. 6



GORNEY
 19 cm/7½"

3 mm HMI-ENT-839
 4 mm HMI-ENT-840



GUILLEN
 HMI-ENT-841
 19 cm/7½"

HMI-ENT-842
 Obturator
 for 41-1840-20



RITTER-HALLE
 19 cm/7½"

○
 HMI-ENT-843
 Ø 3 mm

○
 HMI-ENT-844
 Ø 4 mm



FAULKNER
 HMI-ENT-845
 21 cm/8¼"



BECKMANN
 ½ 22 cm/8¾"

Fig.

1	13 mm	HMI-ENT-846
2	15 mm	HMI-ENT-847
3	17 mm	HMI-ENT-848
4	19 mm	HMI-ENT-849
5	21 mm	HMI-ENT-850
6	23 mm	HMI-ENT-851



BECKMANN
 ½ 21.5 cm/8½"

Fig.

1	13 mm	HMI-ENT-852
2	15 mm	HMI-ENT-853
3	17 mm	HMI-ENT-854
4	19 mm	HMI-ENT-855
5	21 mm	HMI-ENT-856
6	23 mm	HMI-ENT-857



KRESSNER
HMI-ENT-858
22 cm/8¾"



COTTLE-WALSHAM
16 cm/6¼"



HMI-ENT-859
Straight



HMI-ENT-860
Left



HMI-ENT-861
Right



ASCH
HMI-ENT-862
22.5 cm/9"

½



Sinus Surgery

- Antrum Cannula
- Antrum Currettes
- Antrum Punches
- Nasal Cutting Forceps
- Nasal Dressing Forceps
- Nasal Scissors
- Punches
- Sickle Knives
- Sinus Probes
- Sinus Seekers
- Spoon Forceps

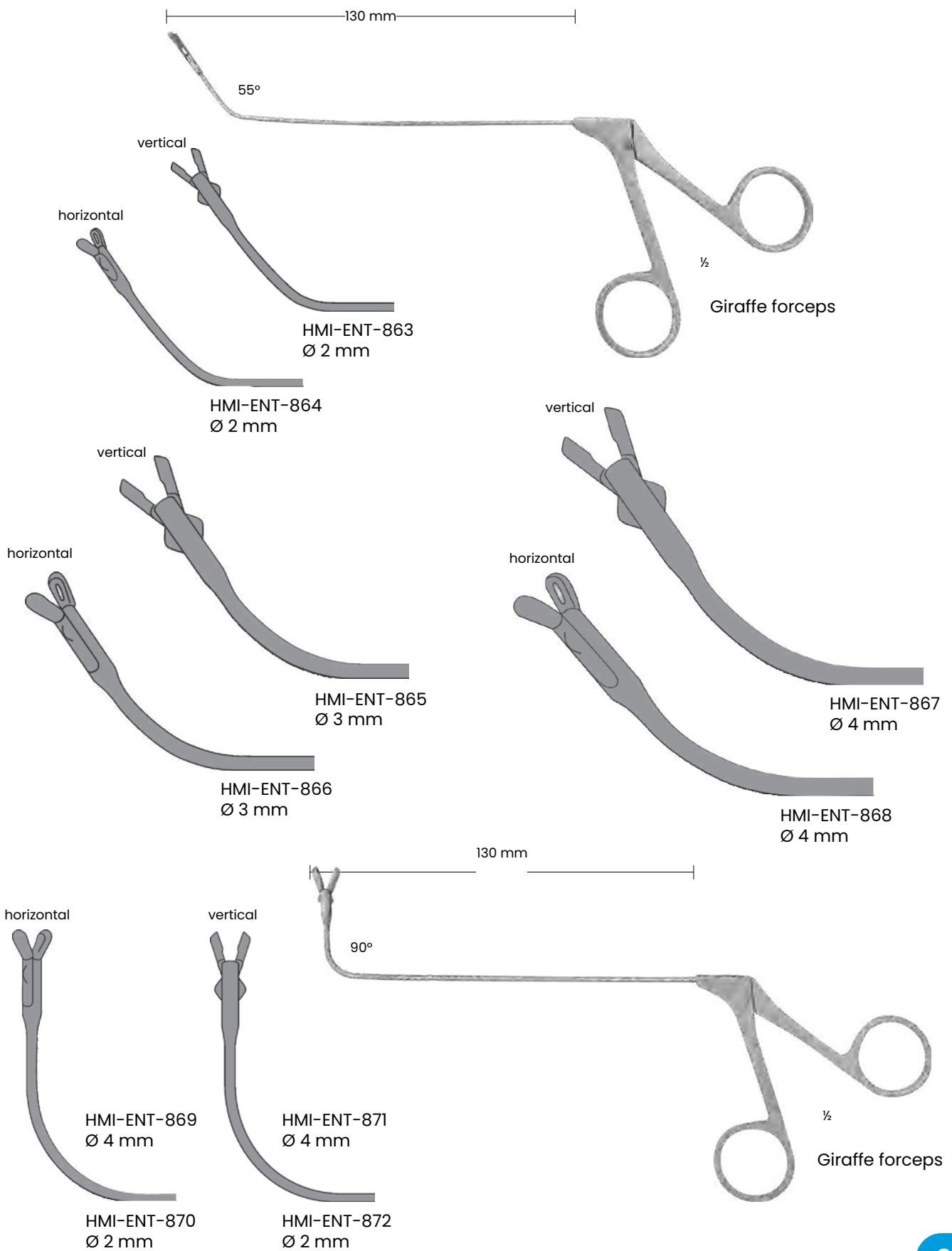

upside backward



HMI-ENT-873 Adult HMI-ENT-874 Pediatric

right side backward

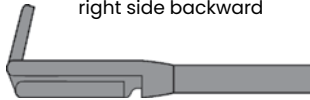

HMI-ENT-877 Adult HMI-ENT-878 Pediatric

downside backward



HMI-ENT-875 Adult HMI-ENT-876 Pediatric

left side backward

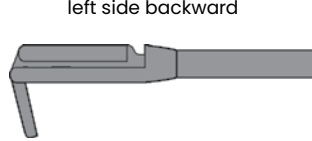

HMI-ENT-879 Adult HMI-ENT-880 Pediatric

Backward cutting



HMI-ENT-881 Adult HMI-ENT-882 Pediatric

downwards curved

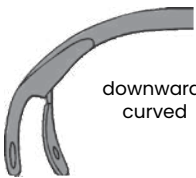

HMI-ENT-883

left curved

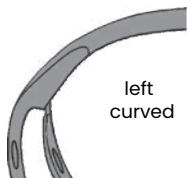

HMI-ENT-884

upwards curved

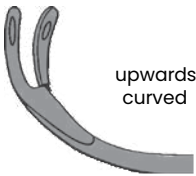

HMI-ENT-885

right curved

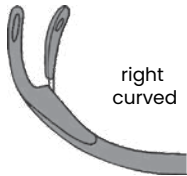

HMI-ENT-886

Fixed jaw curved 90°, movable opening jaw up to 120° backwards

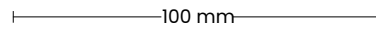

HEUWIESER

360°

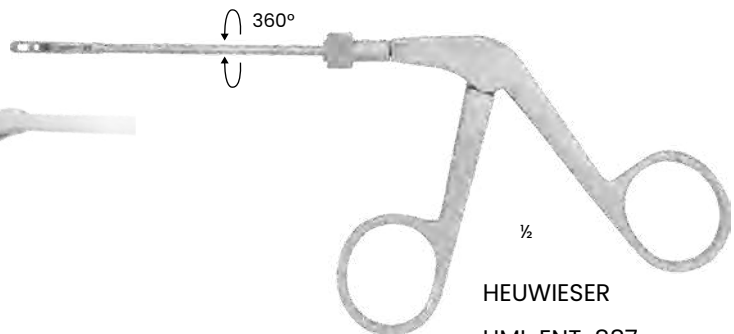



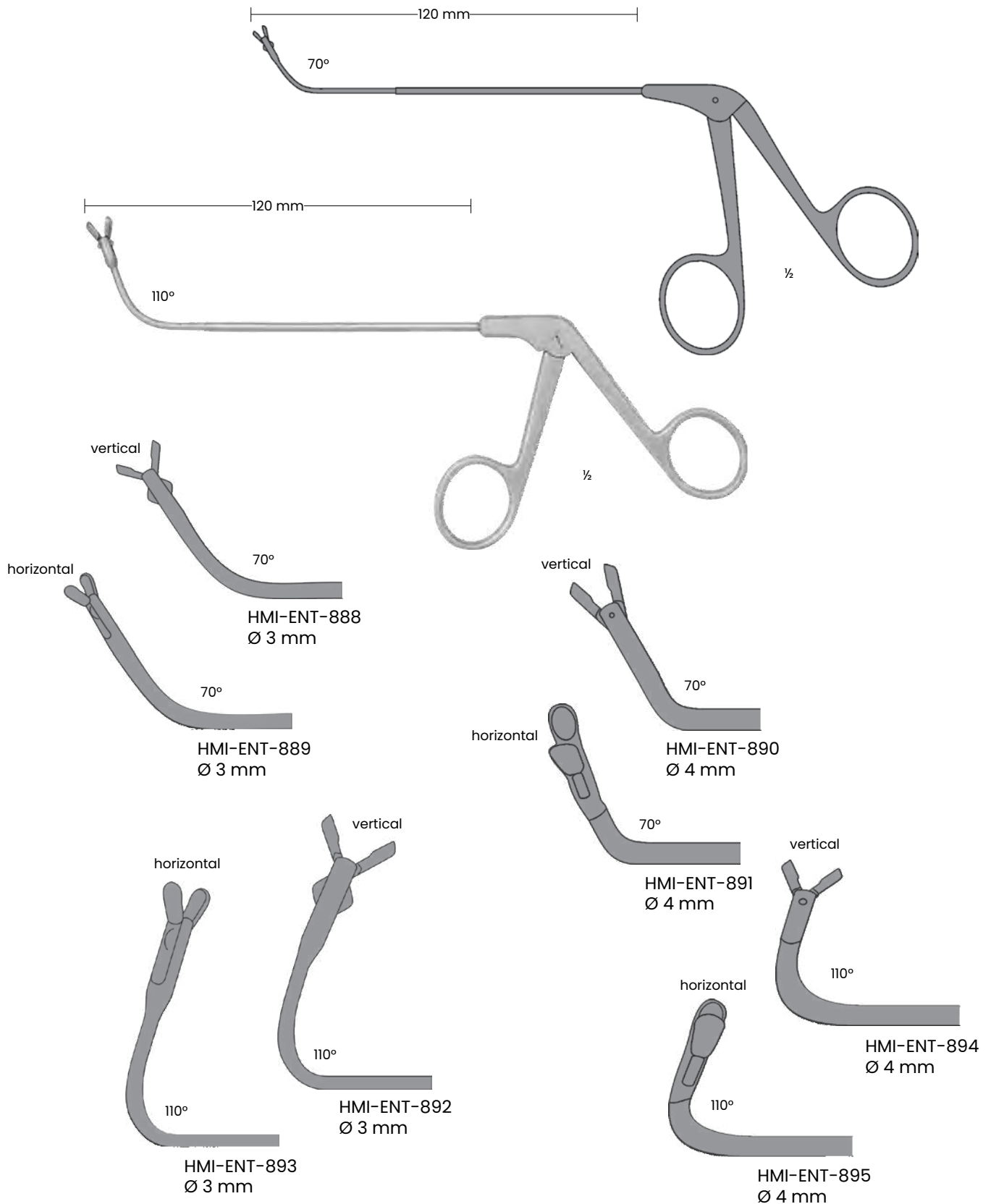



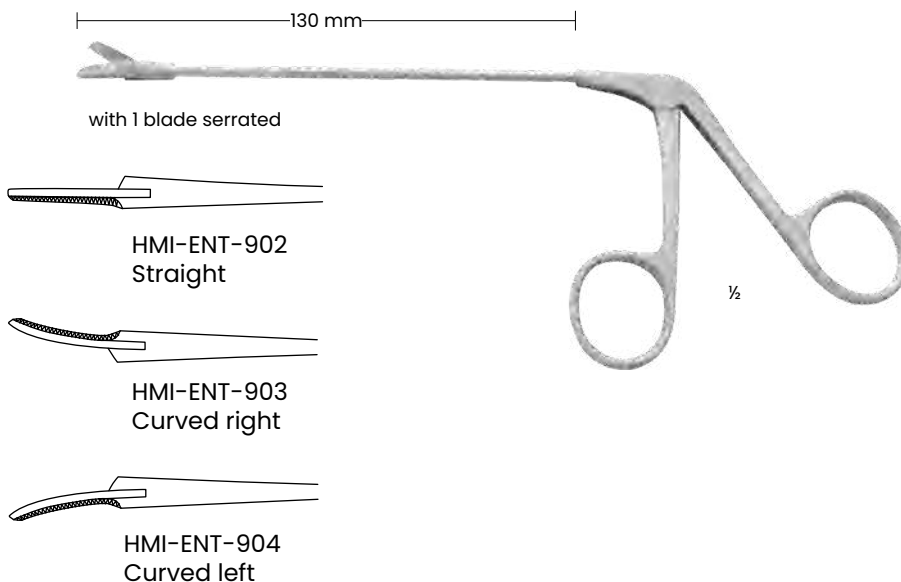
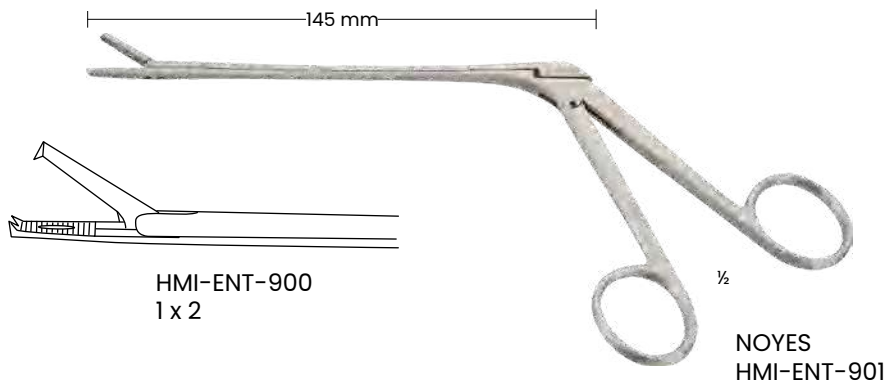
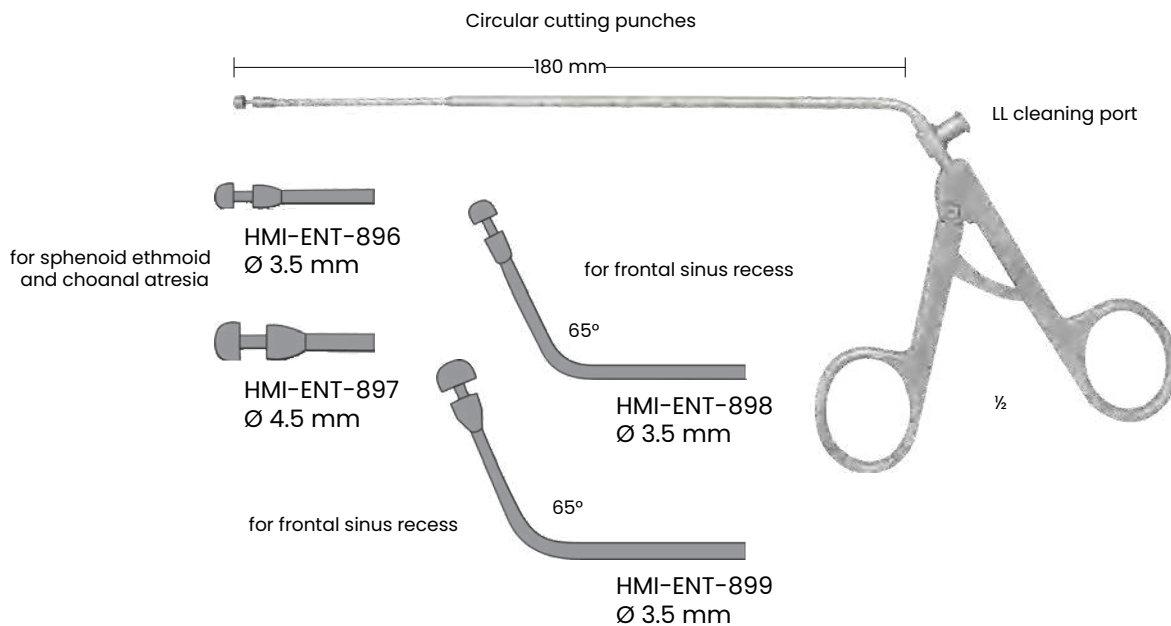







HEUWIESER
HMI-ENT-887

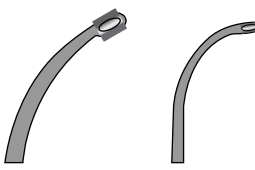

Let Us know if you could not find what you are looking for



<p>Oval</p>  <p>1/2 19 cm/7 1/2"</p>	<p>Antrum Curettes</p>  <p>HMI-ENT-905 Fig. 1 HMI-ENT-906 Fig. 2 HMI-ENT-907 Fig. 3</p>	<p>Round</p>  <p>1/2 19 cm/7 1/2"</p>	<p>Round</p>  <p>HMI-ENT-908 Small</p>	<p>Oblong</p>  <p>HMI-ENT-909 Small</p>	<p>Oblong</p>  <p>HMI-ENT-910 Large</p>	<p>Forward cutting</p>  <p>1/2 19 cm/7 1/2"</p>	<p>Backward cutting</p>  <p>HMI-ENT-911 HMI-ENT-912</p>
<p>Frontal sinus cures</p>  <p>1/2 19 cm/7 1/2"</p>	<p>Oblong small forward cutting</p>  <p>HMI-ENT-913 55° HMI-ENT-914 90°</p>	<p>Sickle knife</p>  <p>1/2 19 cm/7 1/2"</p>	<p>pointed</p>  <p>HMI-ENT-915</p>	<p>round blunt, double-cutting</p>  <p>HMI-ENT-916</p>	<p>Probe, mixllary sinus ostium seeker double ended, ball-shaped ends</p>  <p>1/2 19 cm/7 1/2"</p> <p>Ø 1.2 mm</p>	<p>Frontal sinus probe, angled hook at one tip</p>  <p>1/2 22 cm/8 1/2"</p> <p>Ø 2 mm</p> <p>double ended ball-shaped ends</p> <p>Ø 1.2 mm</p>	

Let Us know if you could not find what you are looking for

Larynx, Tonsil

- Injection Needles
- Laryngeal Forceps
- Laryngeal Mirrors
- Laryngeal Polypus Forceps
- Retractors
- Tampon Forceps
- Tongue Depressor
- Tonsil Hemostatic Forceps
- Tonsil Knives
- Tonsil Punches
- Tonsil Seizing Forceps
- Tracheal Instruments



Let Us know if you could not find what you are looking for

Tonsil grasping forceps



WHITE
 HMI-ENT-936
 18 cm/7"



BLOHMKE
 HMI-ENT-937
 20 cm/8"

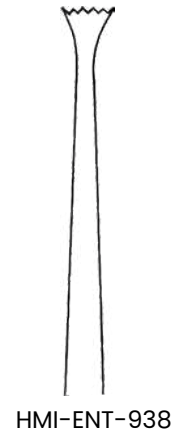

HMI-ENT-938

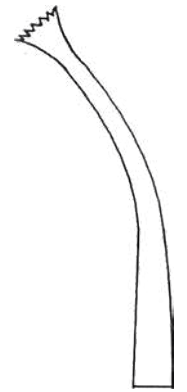

HMI-ENT-939

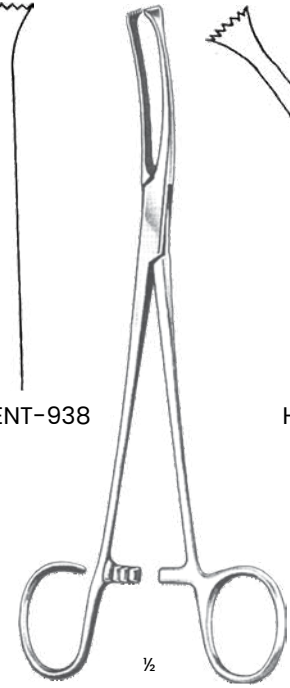

COLVER
 19 cm/7 1/2"

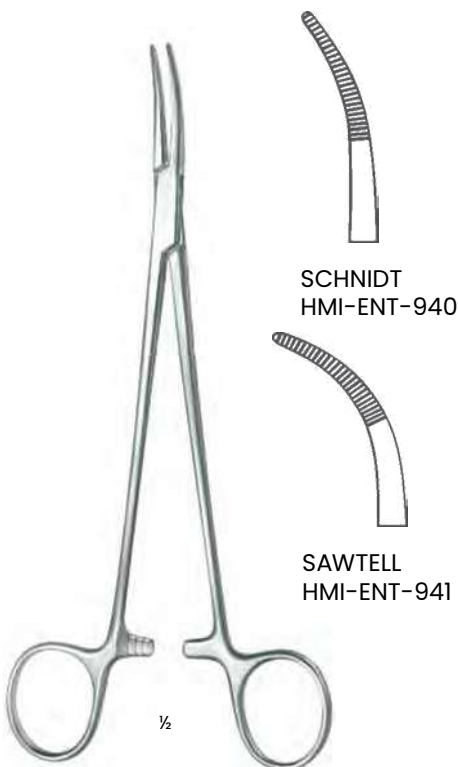

19 cm/7 1/2"

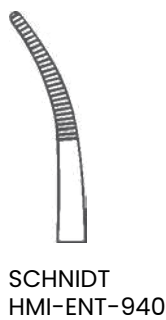

SCHNIDT
 HMI-ENT-940

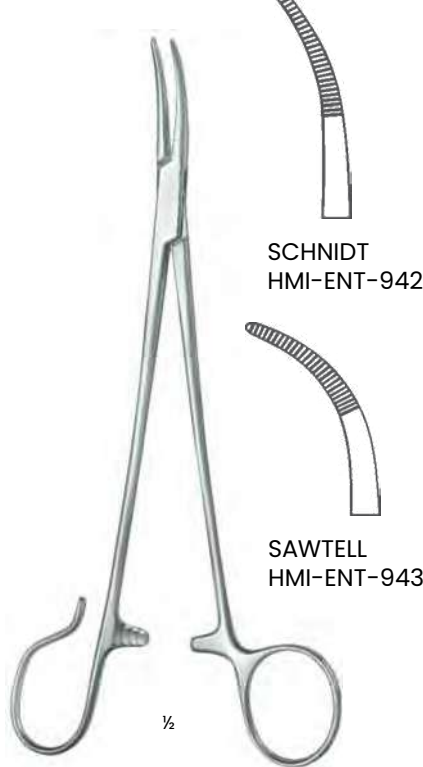

19 cm/7 1/2"

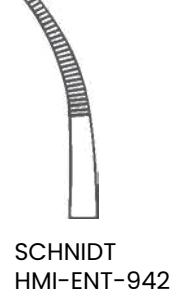

SCHNIDT
 HMI-ENT-942

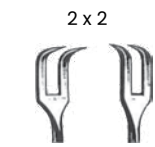

HMI-ENT-944
 Fig. 1

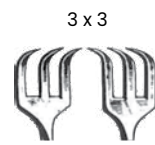

HMI-ENT-945
 Fig. 2

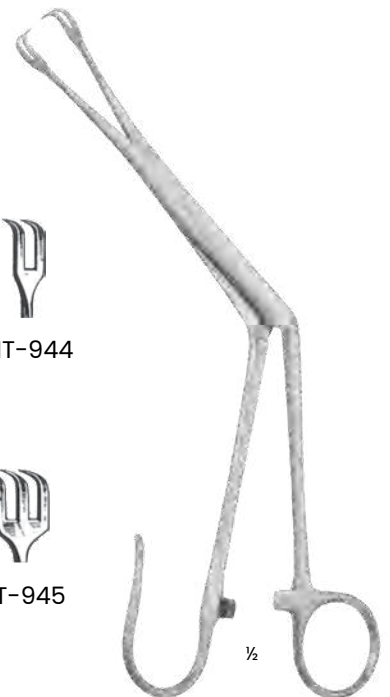

TIVNEN-TYDINGS
 21 cm/8 1/4"

Let Us know if you could not find what you are looking for

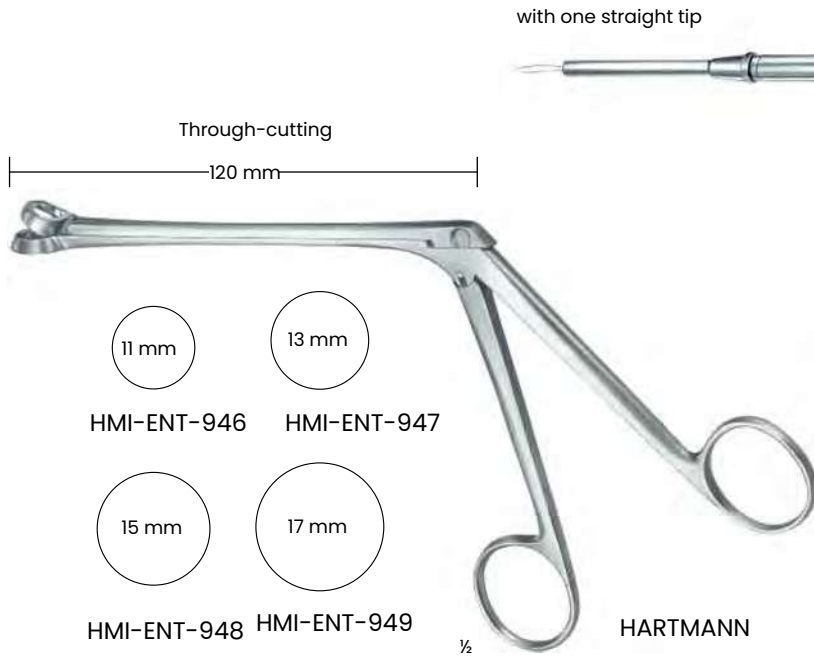

with one straight tip

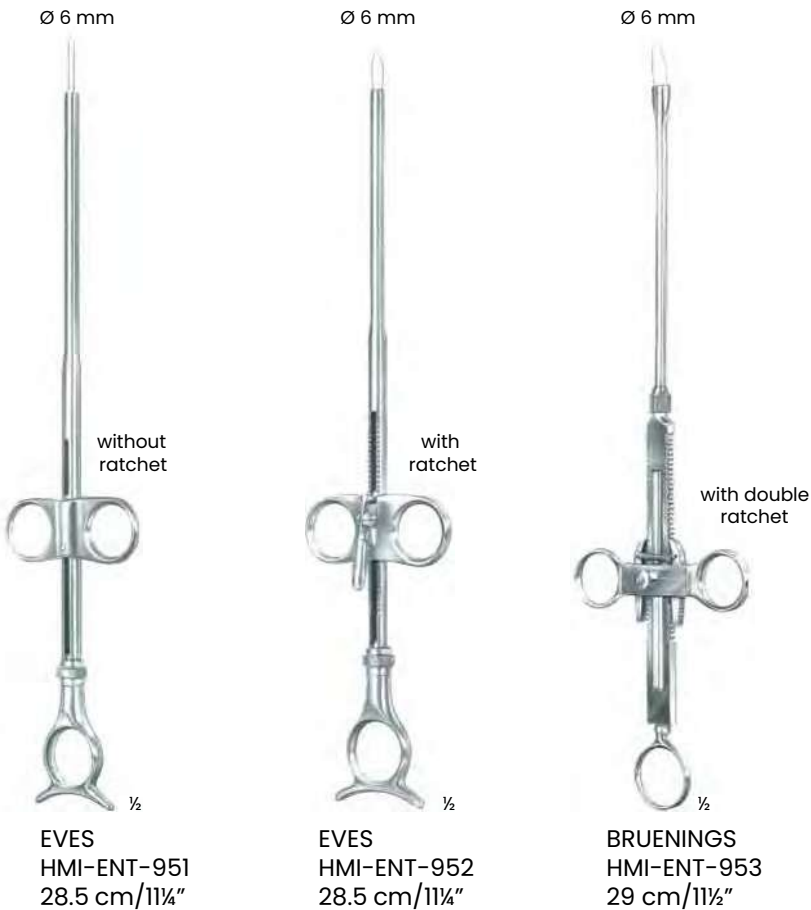
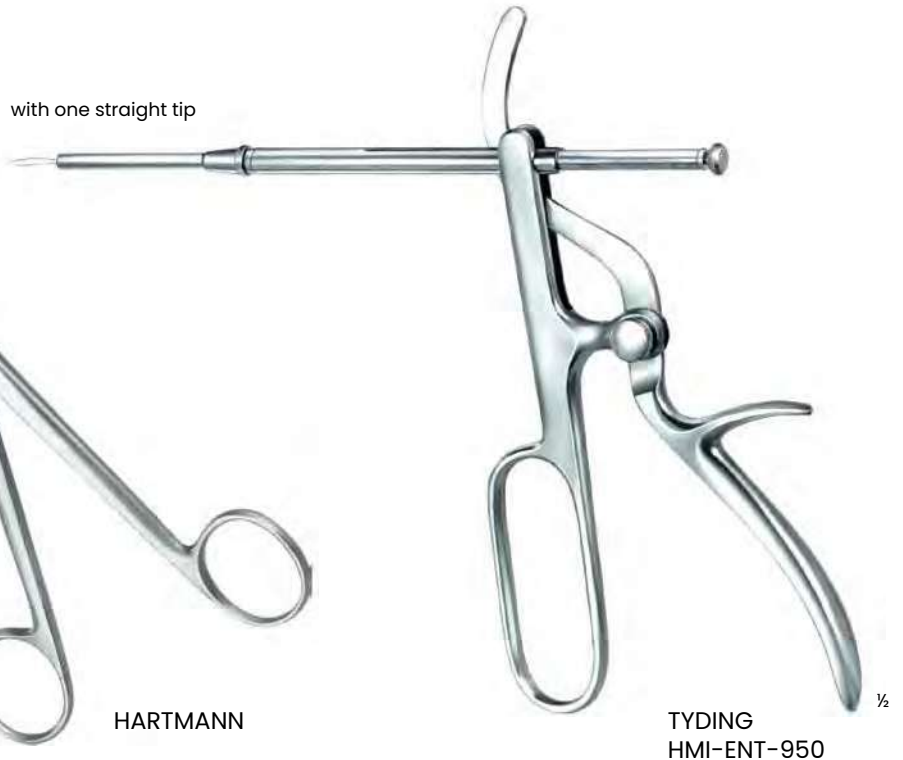

Wire Loop for 42-4506-28
 package of 100 pieces

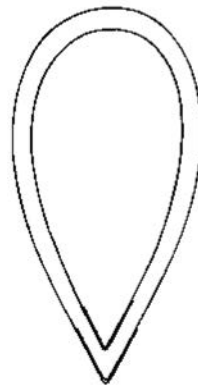

Ø 40 x 0.3 mm HMI-ENT-954
 Ø 50 x 0.3 mm HMI-ENT-955

Snare Wire for 42-4500-28 - 42-4502-28
 42-4525-01

Ø 0.3 mm



HMI-ENT-956

Let Us know if you could not find what you are looking for



BRUENINGS
 22 cm/8 $\frac{3}{4}$ " HMI-ENT-957
 32 cm/12 $\frac{3}{4}$ " HMI-ENT-958
 41 cm/16 $\frac{1}{4}$ " HMI-ENT-959



BRUENINGS
 HMI-ENT-960
 18 cm/7"



HUBER
 HMI-ENT-961 $\frac{1}{2}$



FRAENKEL
 HMI-ENT-962



SEIFFERT
 HMI-ENT-963



FRAENKEL
 HMI-ENT-964



SCHEINMANN
 HMI-ENT-965



SCHEINMANN
 HMI-ENT-966



BRUENINGS
 Fig. 2 HMI-ENT-967
 Fig. 3 HMI-ENT-968



BRUENINGS
 Fig. 2 HMI-ENT-969
 Fig. 3 HMI-ENT-970



LANGE
 HMI-ENT-971



KRAUSE
 Fig. 1 HMI-ENT-972
 Fig. 2 HMI-ENT-973



KRAUSE
 HMI-ENT-974

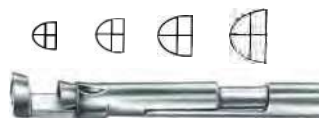

CORDES
 Fig. 1 HMI-ENT-975
 Fig. 2 HMI-ENT-976
 Fig. 3 HMI-ENT-977
 Fig. 4 HMI-ENT-978



SCHUMACHER
 HMI-ENT-979



CORDES
 Fig. 1 HMI-ENT-980
 Fig. 2 HMI-ENT-981



CORDES
 HMI-ENT-982



ROSENBERG
 HMI-ENT-983

Let Us know if you could not find what you are looking for

Plane, with fixed handle



18.5 cm / 7 1/4"

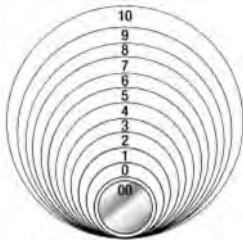
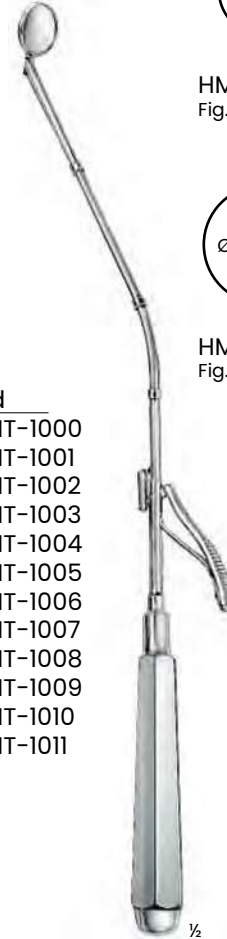

Fig. 00	Ø 8 mm	HMI-ENT-988
Fig. 0	Ø 10 mm	HMI-ENT-989
Fig. 1	Ø 12 mm	HMI-ENT-990
Fig. 2	Ø 14 mm	HMI-ENT-991
Fig. 3	Ø 16 mm	HMI-ENT-992
Fig. 4	Ø 18 mm	HMI-ENT-993
Fig. 5	Ø 20 mm	HMI-ENT-994
Fig. 6	Ø 22 mm	HMI-ENT-995
Fig. 7	Ø 24 mm	HMI-ENT-996
Fig. 8	Ø 26 mm	HMI-ENT-997
Fig. 9	Ø 28 mm	HMI-ENT-998
Fig. 10	Ø 30 mm	HMI-ENT-999

Moveable mirror



MICHEL
27 cm / 7 1/2"



HMI-ENT-984
Fig. 1



HMI-ENT-985
Fig. 2

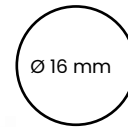

HMI-ENT-986
Fig. 3

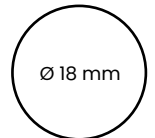

HMI-ENT-987
Fig. 4

Rhodium front coated

Fig. 00	Ø 8 mm	HMI-ENT-1000
Fig. 0	Ø 10 mm	HMI-ENT-1001
Fig. 1	Ø 12 mm	HMI-ENT-1002
Fig. 2	Ø 14 mm	HMI-ENT-1003
Fig. 3	Ø 16 mm	HMI-ENT-1004
Fig. 4	Ø 18 mm	HMI-ENT-1005
Fig. 5	Ø 20 mm	HMI-ENT-1006
Fig. 6	Ø 22 mm	HMI-ENT-1007
Fig. 7	Ø 24 mm	HMI-ENT-1008
Fig. 8	Ø 26 mm	HMI-ENT-1009
Fig. 9	Ø 28 mm	HMI-ENT-1010
Fig. 10	Ø 30 mm	HMI-ENT-1011

Plane, without handle



13.5 cm / 5 1/4"

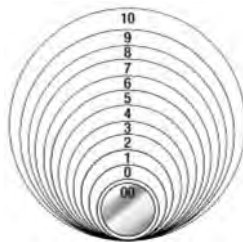

Fig. 00	Ø 8 mm	HMI-ENT-1012
Fig. 0	Ø 10 mm	HMI-ENT-1013
Fig. 1	Ø 12 mm	HMI-ENT-1014
Fig. 2	Ø 14 mm	HMI-ENT-1015
Fig. 3	Ø 16 mm	HMI-ENT-1016
Fig. 4	Ø 18 mm	HMI-ENT-1017
Fig. 5	Ø 20 mm	HMI-ENT-1018
Fig. 6	Ø 22 mm	HMI-ENT-1019
Fig. 7	Ø 24 mm	HMI-ENT-1020
Fig. 8	Ø 26 mm	HMI-ENT-1021
Fig. 9	Ø 28 mm	HMI-ENT-1022
Fig. 10	Ø 30 mm	HMI-ENT-1023

Rhodium front coated

Fig. 00	Ø 8 mm	HMI-ENT-1024
Fig. 0	Ø 10 mm	HMI-ENT-1025
Fig. 1	Ø 12 mm	HMI-ENT-1026
Fig. 2	Ø 14 mm	HMI-ENT-1027
Fig. 3	Ø 16 mm	HMI-ENT-1028
Fig. 4	Ø 18 mm	HMI-ENT-1029
Fig. 5	Ø 20 mm	HMI-ENT-1030
Fig. 6	Ø 22 mm	HMI-ENT-1031
Fig. 7	Ø 24 mm	HMI-ENT-1032
Fig. 8	Ø 26 mm	HMI-ENT-1033
Fig. 9	Ø 28 mm	HMI-ENT-1034
Fig. 10	Ø 30 mm	HMI-ENT-1035



HMI-ENT-1036
11 cm / 4 1/4"



HMI-ENT-1037
12.5 cm / 5"

Let Us know if you could not find what you are looking for



FRAENKEL
HMI-ENT-1038
18 cm/7"

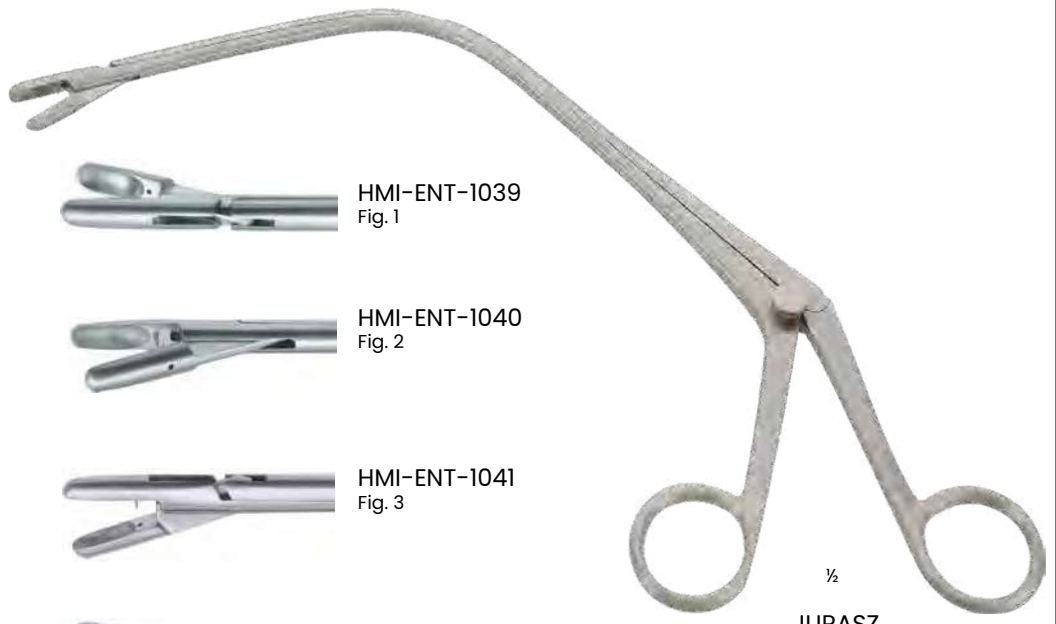

HMI-ENT-1039
Fig. 1

HMI-ENT-1040
Fig. 2

HMI-ENT-1041
Fig. 3

HMI-ENT-1042
Fig. 4

1/2
JURASZ
23 cm/9"

13.5 mm

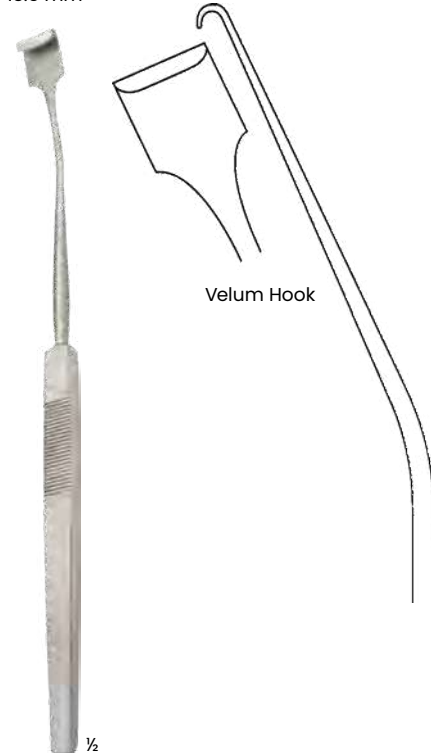

NAGER
HMI-ENT-1043
19 cm/17 1/2"

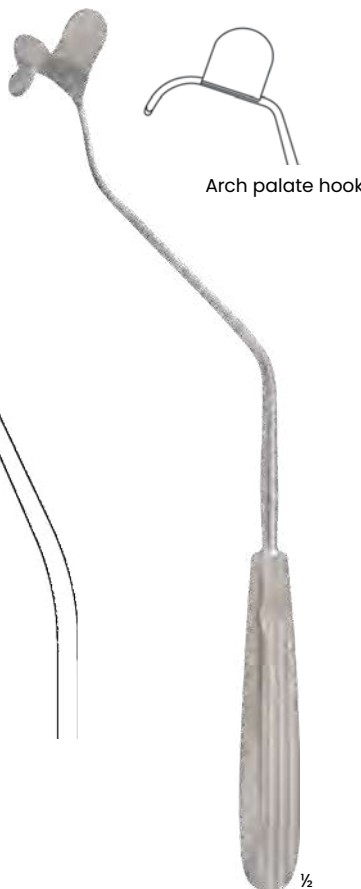

Arch palate hook

Velum Hook

HOFER
HMI-ENT-1044
24 cm/9 1/2"



REICHERT
HMI-ENT-1045
24 cm/9 1/2"

3 mm

3 mm



JACKSON
HMI-ENT-1046
22 cm/8 3/4"

HMI-ENT-1047

Let Us know if you could not find what you are looking for

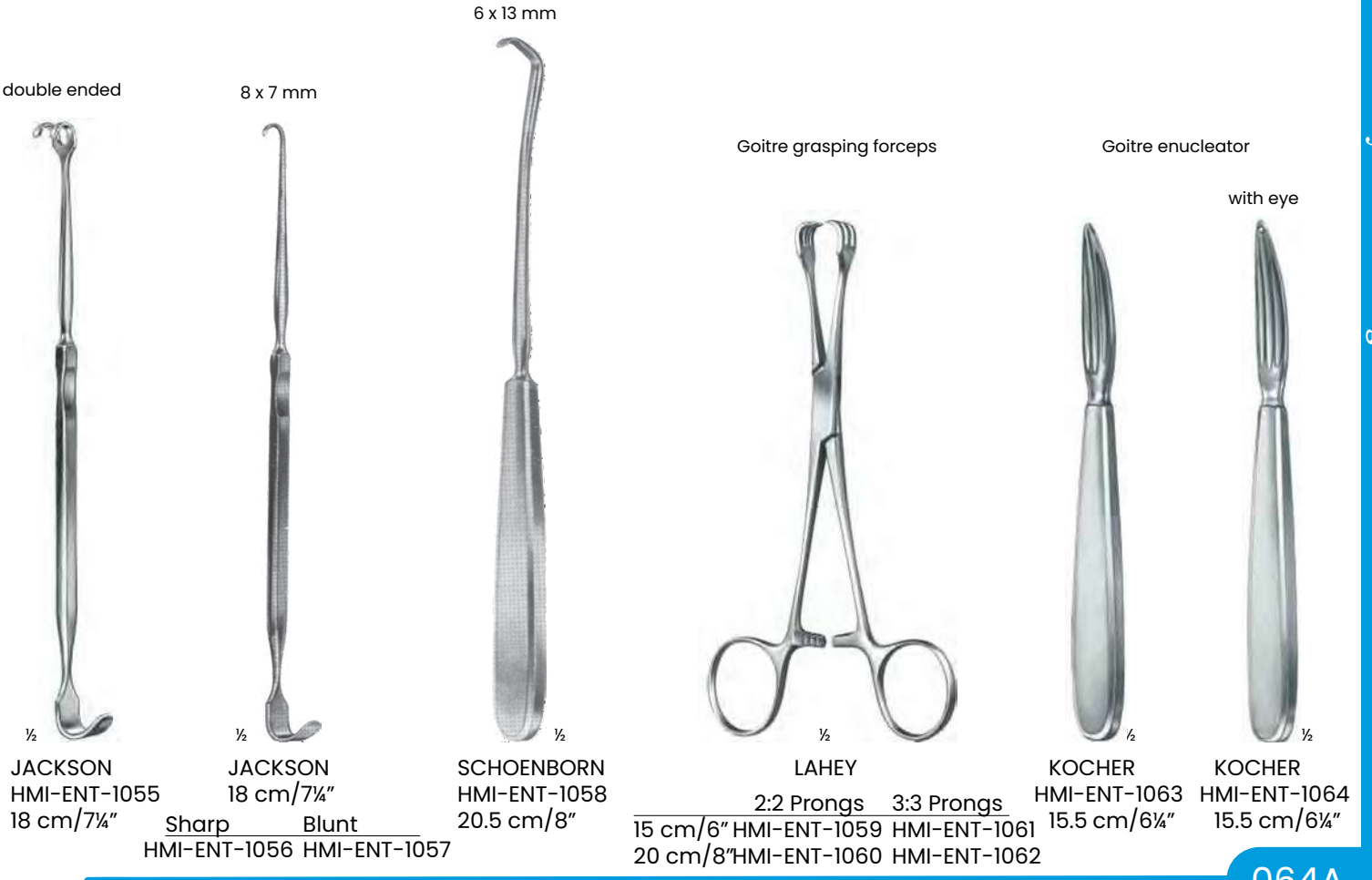
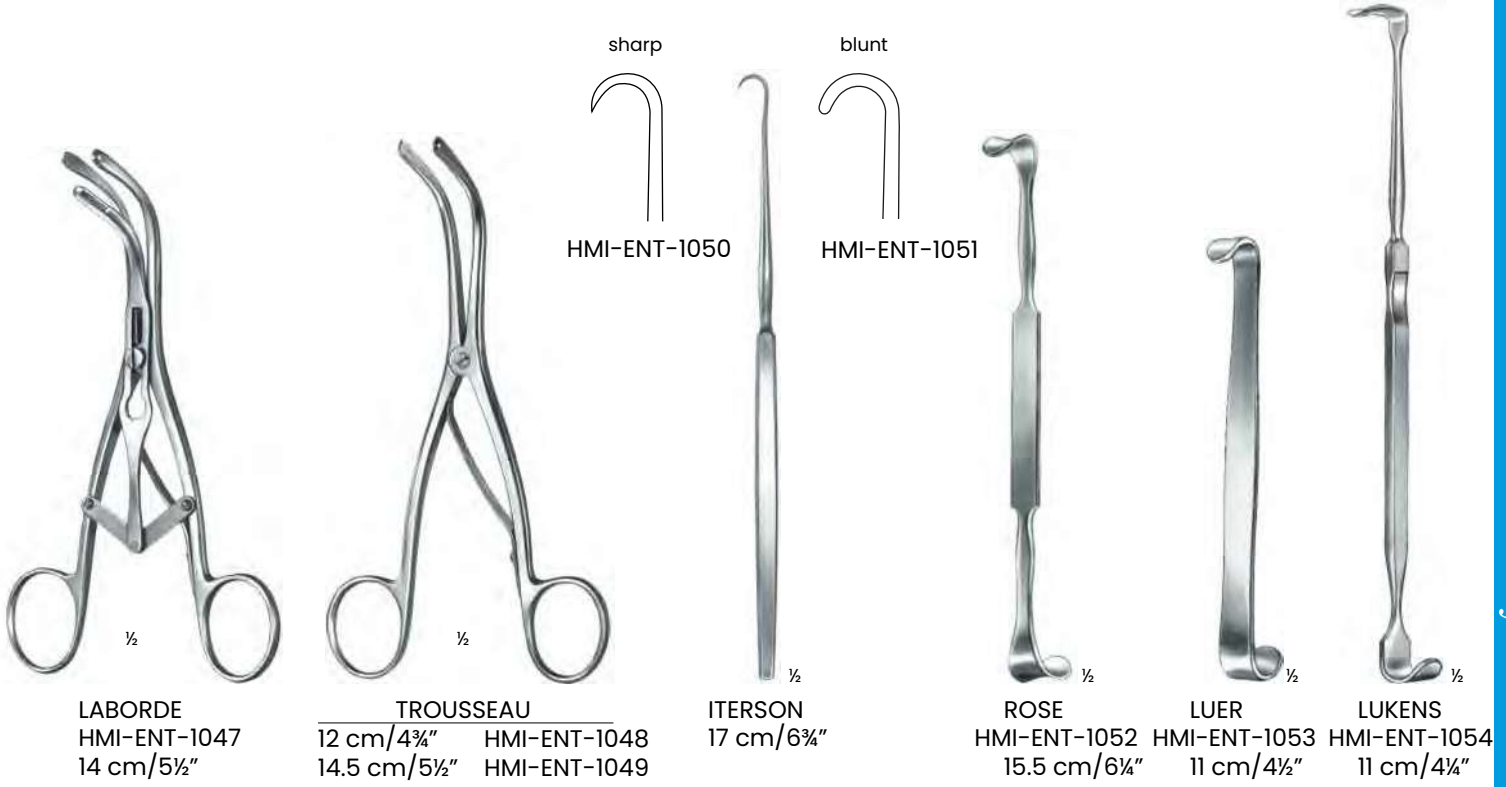

Let Us know if you could not find what you are looking for

Microlaryngology

- Chest Supports
- Cotton Carriers
- Injection Cannulas
- Light Guide Carriers
- Microlaryngology Forceps
- Microlaryngology Instruments
- Microlaryngology Needle Holders
- Microlaryngology Scissors
- Operating Laryngoscopes
- Suction Tubes
- Teeth Protectors

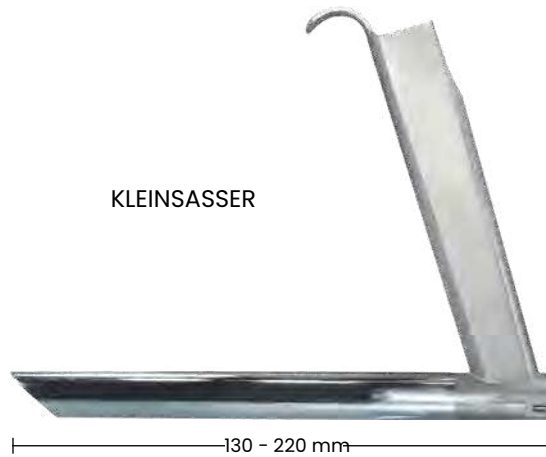

KLEINSASSER

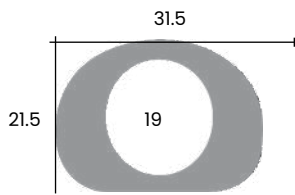

HMI-ENT-1065
 17 cm/6 3/4"
 Adult X - Large

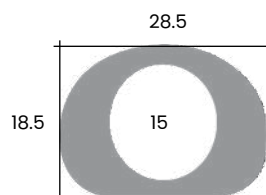

HMI-ENT-1066
 17 cm/6 3/4"
 Adult Large

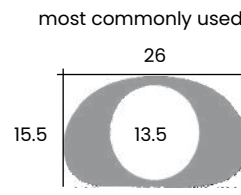

HMI-ENT-1067
 17 cm/6 3/4"
 Adult Medium

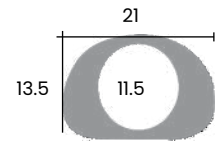

HMI-ENT-1068
 18 cm/7"
 Adult Small

most commonly used model particularly difficult anatomical circumstances

for anterior commissure

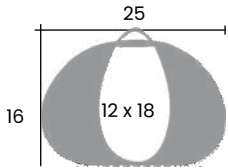

HMI-ENT-1069
 18 cm/7"
 Adult Medium

especially long neck

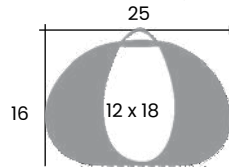

HMI-ENT-1070
 22 cm/8 3/4"
 Adult Medium

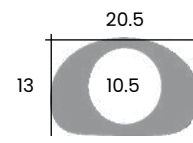

HMI-ENT-1071
 15 cm/6"
 Children Small

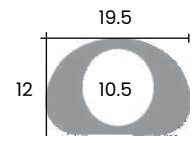

HMI-ENT-1072
 13 cm/5"
 Infant Small

Fiber Optic Light Guide Clip
 For proximal illumination

HMI-ENT-1073



Fiber Optic Light Guide Carriers
 for distal illumination

	Working length	Use with
HMI-ENT-1074	7.5 cm/3"	HMI-ENT-1071 - HMI-ENT-1072
HMI-ENT-1075	14 cm/5 1/2"	HMI-ENT-1065- HMI-ENT-1070

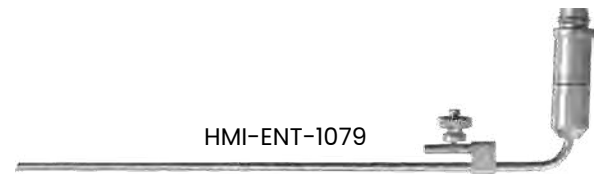

HMI-ENT-1079

Suction Tubes

To remove vapor, for LASER treatment, Dia. Ø 3 mm

	Working length	Use with
HMI-ENT-1076	9 cm/3 1/2"	HMI-ENT-1071 - HMI-ENT-1072
HMI-ENT-1077	12.5 cm/5"	HMI-ENT-1065- HMI-ENT-1070

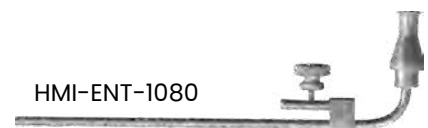

HMI-ENT-1080

Injection Cannula

for positive pressure assisted ventilation

	Working length	Use with
HMI-ENT-1078	12.5 cm/5"	HMI-ENT-1071 - HMI-ENT-1072

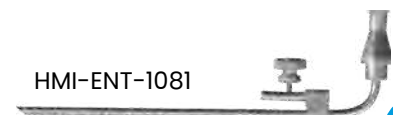

HMI-ENT-1081

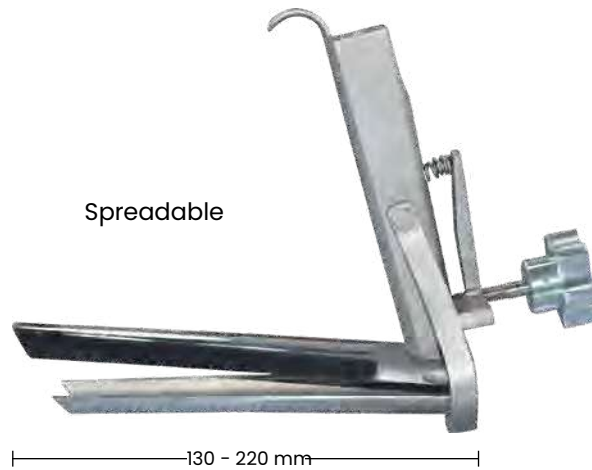

Spreadable

130 - 220 mm

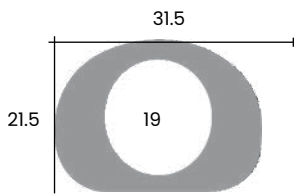

HMI-ENT-1082
 17 cm/6 3/4"
 Adult X - Large

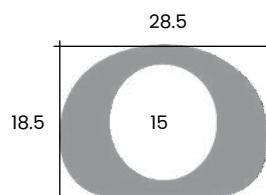

HMI-ENT-1083
 17 cm/6 3/4"
 Adult Large

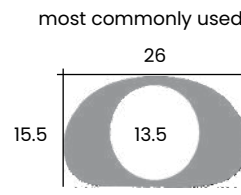

HMI-ENT-1084
 17 cm/6 3/4"
 Adult Medium

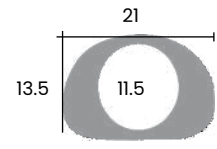

HMI-ENT-1085
 18 cm/7"
 Adult Small

most commonly used model particularly difficult anatomical circumstances

for anterior commissure

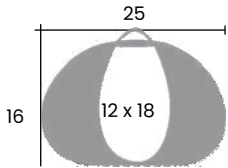

HMI-ENT-1086
 18 cm/7"
 Adult Medium

especially long neck

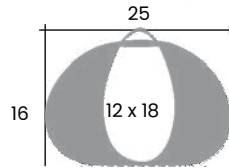

HMI-ENT-1087
 22 cm/8 3/4"
 Adult Medium

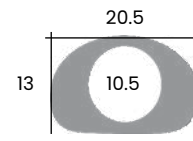

HMI-ENT-1088
 15 cm/6"
 Children Small

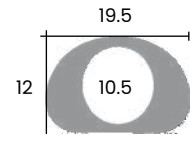

HMI-ENT-1089
 13 cm/5"
 Infant Small

Fiber Optic Light Guide Clip
 For proximal illumination

HMI-ENT-1090

Fiber Optic Light Guide Carriers
 for distal illumination

	Working length	Use with
HMI-ENT-1091	7.5 cm/3"	HMI-ENT-1071 - HMI-ENT-1072
HMI-ENT-1092	14 cm/5 1/2"	HMI-ENT-1065- HMI-ENT-1070

Suction Tubes

To remove vapor, for LASER treatment, Dia. Ø 3 mm

	Working length	Use with
HMI-ENT-1093	9 cm/3 1/2"	HMI-ENT-1071 - HMI-ENT-1072
HMI-ENT-1094	12.5 cm/5"	HMI-ENT-1065- HMI-ENT-1070

Injection Cannula

for positive pressure assisted ventilation

	Working length	Use with
HMI-ENT-1095	12.5 cm/5"	HMI-ENT-1071 - HMI-ENT-1072

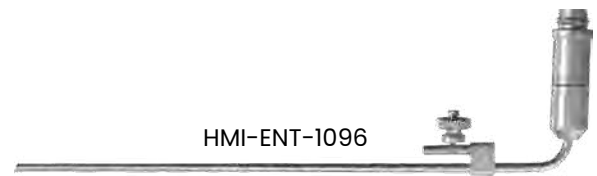

HMI-ENT-1096

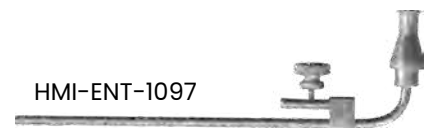

HMI-ENT-1097

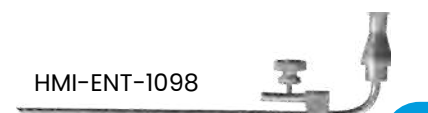

HMI-ENT-1098

Let Us know if you could not find what you are looking for

KLEINSASSER Chest Support

With adjustment wheel, Ring Diameter Ø 9.5 mm

	Working length	for
HMI-ENT-1099	24 cm/9½"	Children
HMI-ENT-1100	34 cm/13½"	Adults

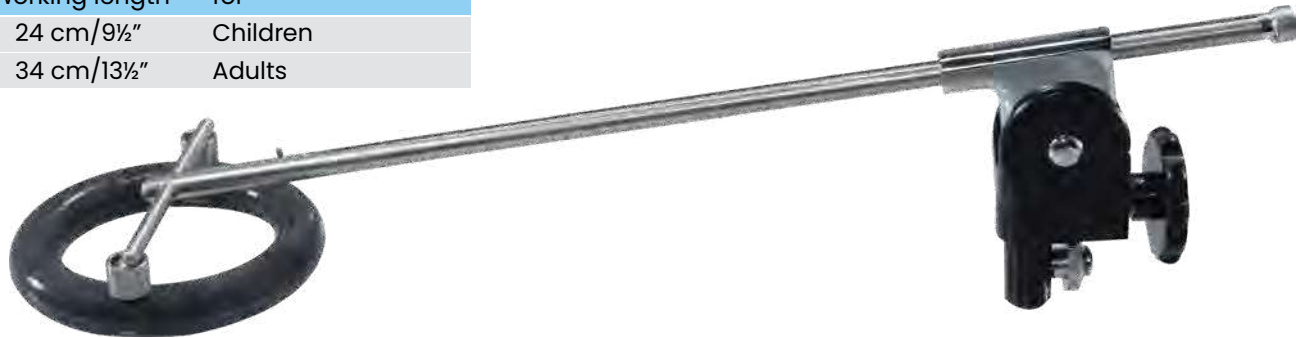

with adjustment wheel

Support Rod Only, With ring

	Working length	for
HMI-ENT-1101	24 cm/9½"	Children
HMI-ENT-1102	34 cm/13½"	Adults



Holder Only

	for
HMI-ENT-1103	Chest Support



Let Us know if you could not find what you are looking for



HOLINGER Operating Laryngoscope
 Complete with light guide

	Use for	Handles	Working Length
HMI-ENT-1104	Babies	Small	12.5 cm/5"
HMI-ENT-1105	Children	Small	17 cm/6¾"
HMI-ENT-1106	Adult	Large	18 cm/7"

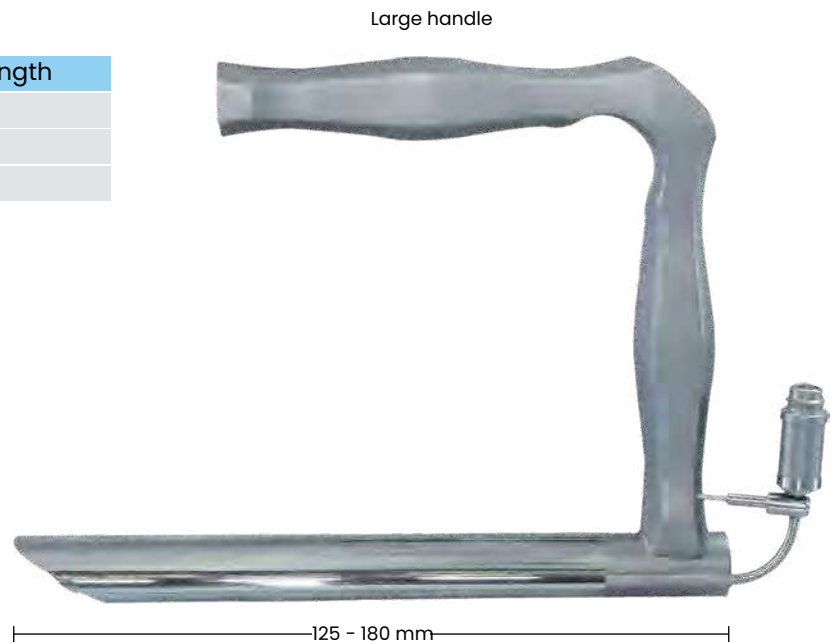

JACKSON Operating Laryngoscope
 Complete with light guide



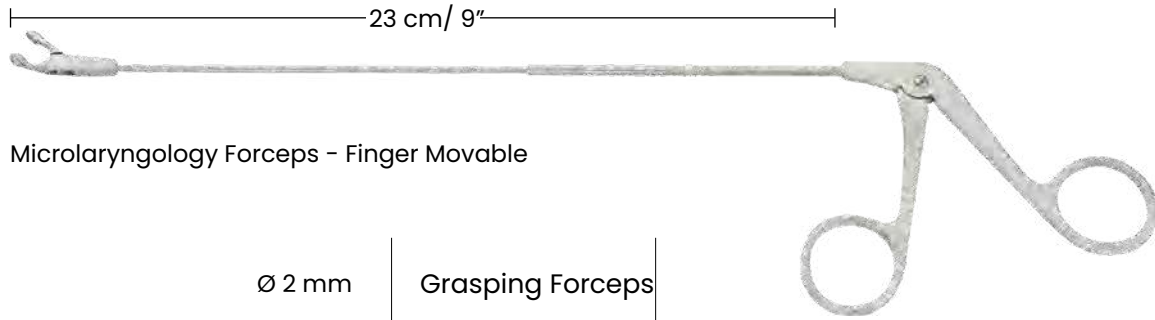









	Use for	Handles	Working Length
HMI-ENT-1107	Babies	Small	12.5 cm/5"
HMI-ENT-1108	Children	Small	17 cm/6¾"
HMI-ENT-1109	Adult	Large	18 cm/7"

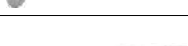

Microsurgery Forceps - Finger Movable

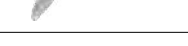
	Ø 2 mm	Grasping Forceps		
	HMI-ENT-1110	Straight		
	HMI-ENT-1111	Upwards		
	HMI-ENT-1112	Curved right		
	HMI-ENT-1113	Curved left		
	Ø 2 mm	Scissors		
	HMI-ENT-1114	Straight		
	HMI-ENT-1115	Upwards 45°		
	HMI-ENT-1116	Curved right		
	HMI-ENT-1117	Curved left		
	HMI-ENT-1118	Curved horizontal		
	Ø 4 mm	Ø 2 mm	Cup Shaped Forceps	
	HMI-ENT-1119	HMI-ENT-1120	Straight	
	HMI-ENT-1121	HMI-ENT-1122	Upwards	
	HMI-ENT-1123	HMI-ENT-1124	Curved right	
	HMI-ENT-1125	HMI-ENT-1126	Curved left	



HMI-ENT-1128	knife, oval, straight	
HMI-ENT-1129	knife, oval, 45°	
HMI-ENT-1130	sickel knife, curved	
HMI-ENT-1131	sickel knife, straight	
HMI-ENT-1132	knife, golf stick shaped	
HMI-ENT-1133	knife, round, vertical cutting	
HMI-ENT-1134	hook, blunt	
HMI-ENT-1135	hook, sharp	
HMI-ENT-1136	hook, with probe end 90°	
HMI-ENT-1137	needle, curved to right	
HMI-ENT-1138	needle, curved to left	
HMI-ENT-1139	elevator, with suction channel	
HMI-ENT-1140	knot pusher / tier	

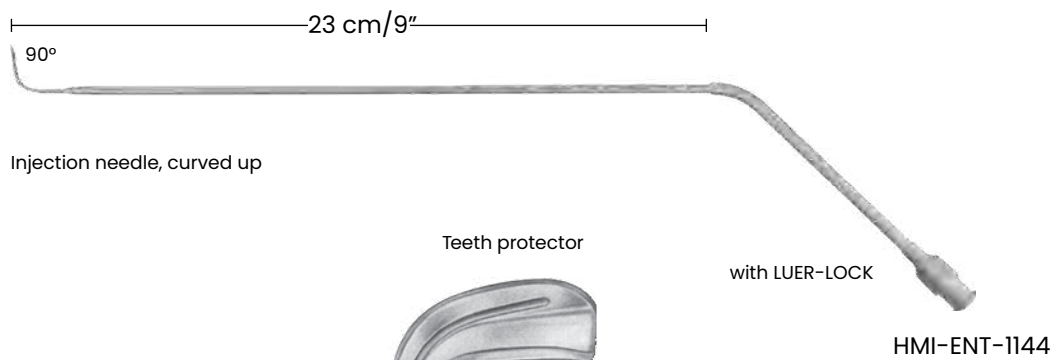
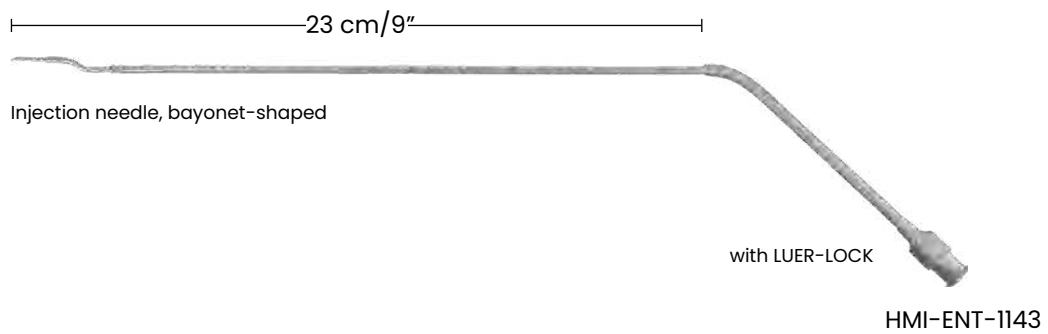
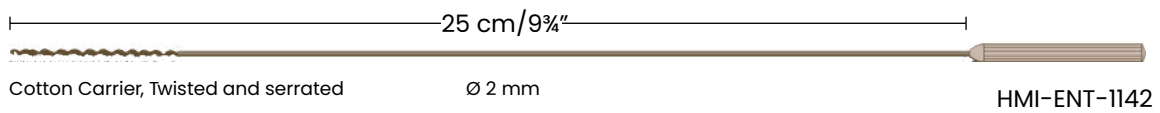
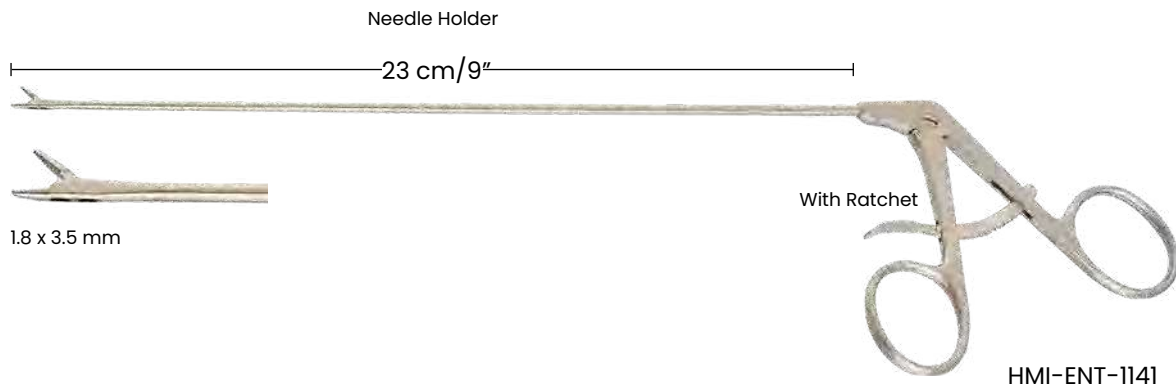

Oral & Maxilo Facial

- Bone Contouring Forceps
- Cheek Retractor
- Chest Support
- Extra Oral Retractors
- Intra Oral Retractors
- Lip & Cheek Vestibulum Retractors
- Mandibular Retractors
- Mouthgags
- Multi Purpose Retractors
- Osteotomes
- Periosteal Elevators
- Ramus Retractors
- Soft Tissue Retractors



43-4224-04
 Fram only



HMI-ENT-1145
 Fig. 3

HMI-ENT-1146
 Fig. 2

HMI-ENT-1147
 Fig. 1

DINGMANN
 HMI-ENT-1148
 Complete Set



HMI-ENT-1149
 Fig. 3

HMI-ENT-1150
 Fig. 2

HMI-ENT-1151
 Fig. 1



McIVOR
 HMI-ENT-1152
 Complete set

Let Us know if you could not find what you are looking for

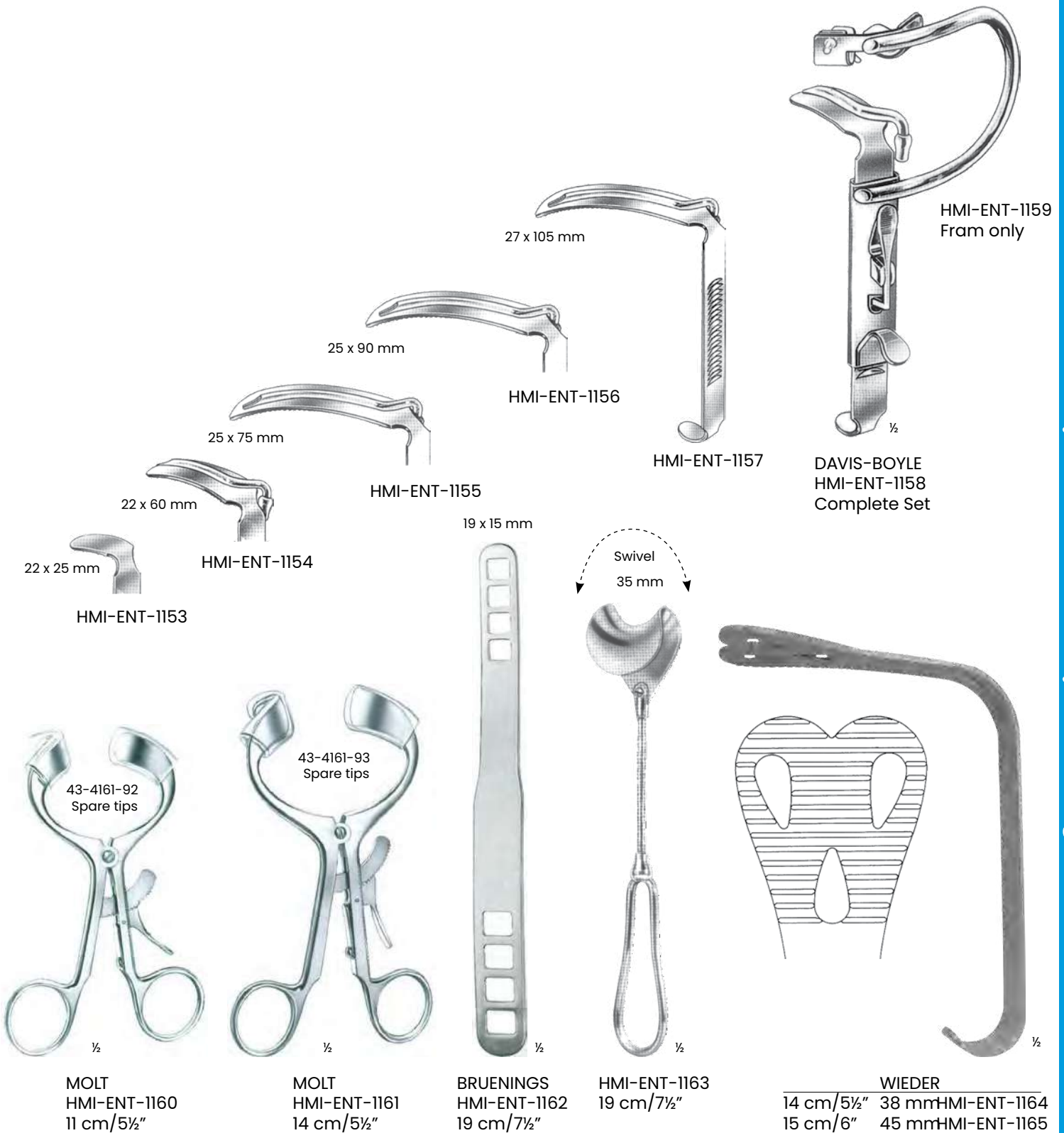

22 x 25 mm

HMI-ENT-1153

22 x 60 mm

HMI-ENT-1154

25 x 75 mm

HMI-ENT-1155

25 x 90 mm

HMI-ENT-1156

27 x 105 mm

HMI-ENT-1157

HMI-ENT-1159
Fram only

DAVIS-BOYLE
HMI-ENT-1158
Complete Set

19 x 15 mm



1/2



1/2

HMI-ENT-1163
19 cm/7 1/2"

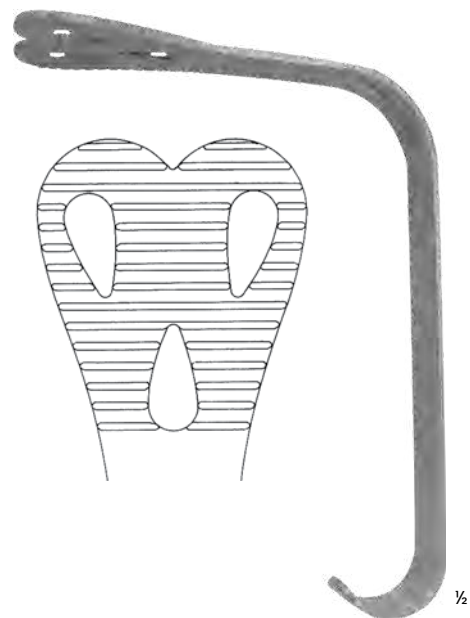

1/2

WIEDER
 14 cm/5 1/2" 38 mm HMI-ENT-1164
 15 cm/6" 45 mm HMI-ENT-1165



1/2

MOLT
HMI-ENT-1160
11 cm/5 1/2"



1/2

MOLT
HMI-ENT-1161
14 cm/5 1/2"

43-4161-93
Spare tips

43-4161-92
Spare tips

BRUENINGS
HMI-ENT-1162
19 cm/7 1/2"

Let Us know if you could not find what you are looking for

Periosteal Elevators

Beveled edge



OBWEGESER
18 cm/7"



HMI-ENT-1166
6 mm



HMI-ENT-1167
7 mm

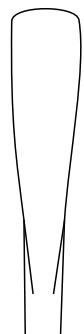

HMI-ENT-1168
9 mm

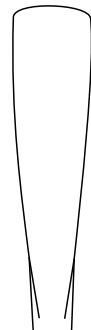

HMI-ENT-1169
11 mm

Flat edge



OBWEGESER
18 cm/7"



HMI-ENT-1170
6 mm



HMI-ENT-1171
7 mm



HMI-ENT-1172
9 mm



HMI-ENT-1173
11 mm



BOIES
HMI-ENT-1174
19.5 cm/8"

Ramus periosteal stripper



OBWEGESER
20.5 cm/8"

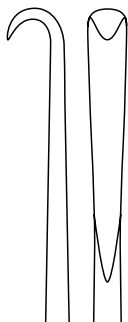

HMI-ENT-1175
5 mm

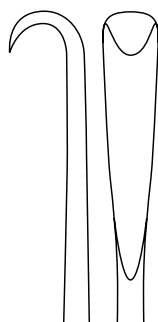

HMI-ENT-1176
7 mm

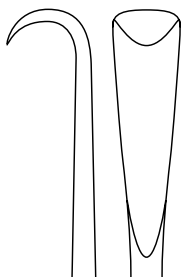

HMI-ENT-1177
9 mm

Ramus periosteal stripper V-notched



OBWEGESER
17.5 cm/7"

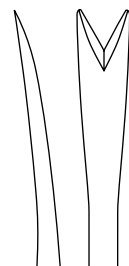

HMI-ENT-1178
7 mm

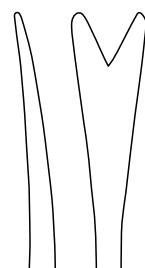

HMI-ENT-1179
9 mm

Mandibular stripper/inferior border raspatory

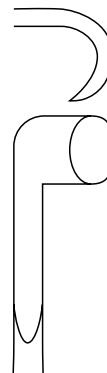

HMI-ENT-1180
left

10 mm



OBWEGESER
18 cm/7"

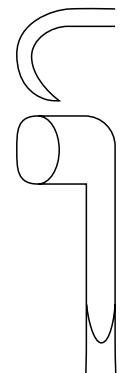

HMI-ENT-1181
right

Let Us know if you could not find what you are looking for

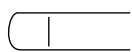
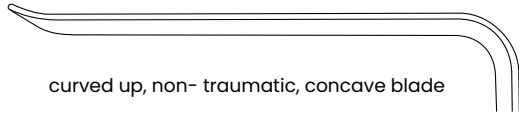

HMI-ENT-1182
5 x 16 mm

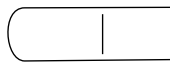

HMI-ENT-1183
7 x 25 mm

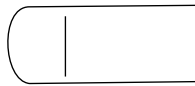

HMI-ENT-1184
10 x 35 mm



HMI-ENT-1185
10 x 42 mm



HMI-ENT-1186
12 x 55 mm

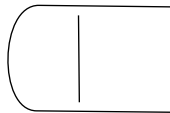

HMI-ENT-1187
14 x 70 mm

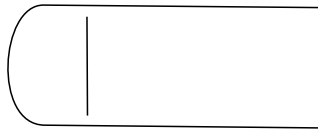

HMI-ENT-1188
16 x 80 mm

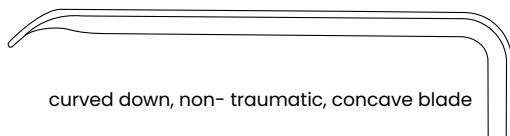

HMI-ENT-1189
5 x 16 mm



HMI-ENT-1190
7 x 25 mm

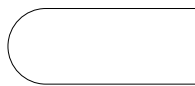

HMI-ENT-1191
10 x 35 mm

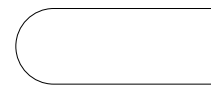

HMI-ENT-1192
10 x 42 mm

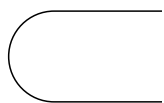

HMI-ENT-1193
12 x 55 mm

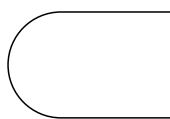

HMI-ENT-1194
14 x 70 mm



HMI-ENT-1195
16 x 80 mm

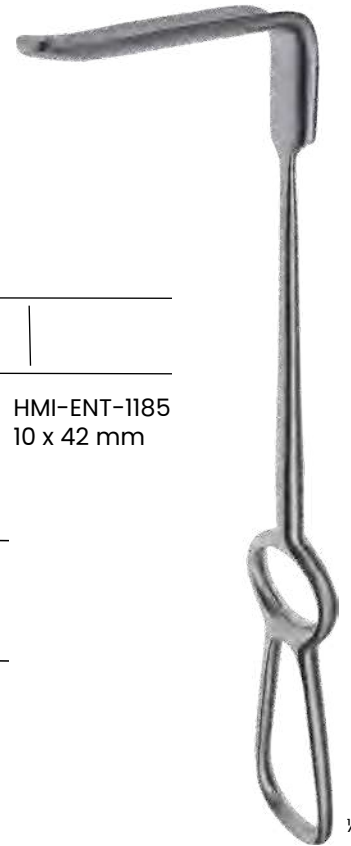

OBWEGESER
22 cm/8¾"



OBWEGESER
22 cm/8¾"

Mandibular channel retractors

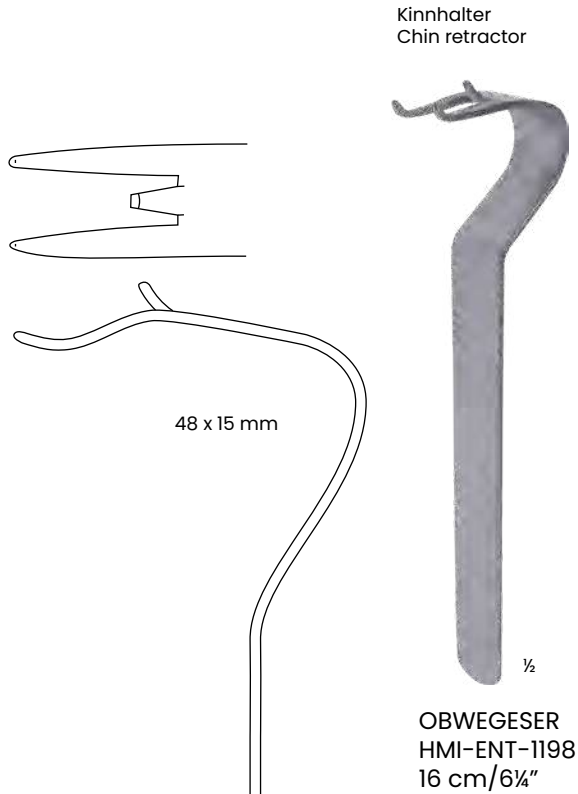
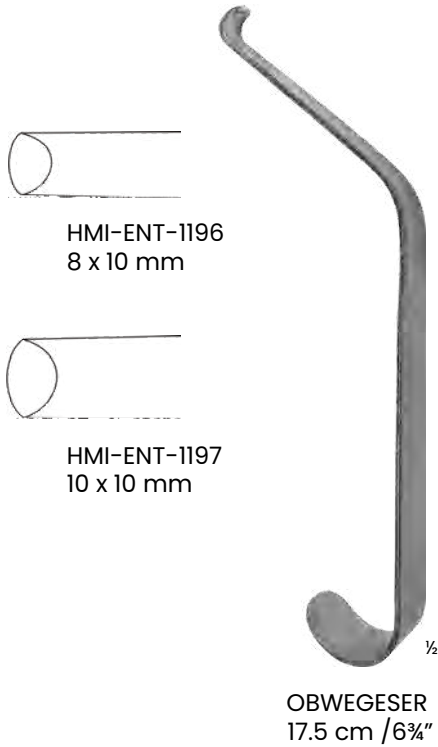

Mandibular retractors

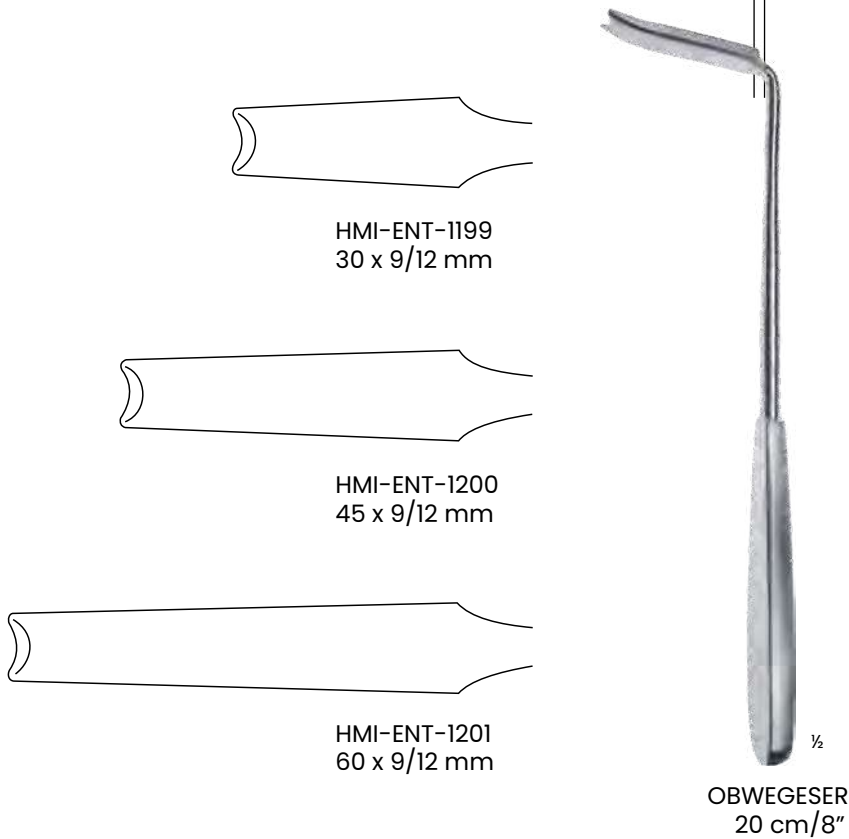

Let Us know if you could not find what you are looking for

Ramus retractor

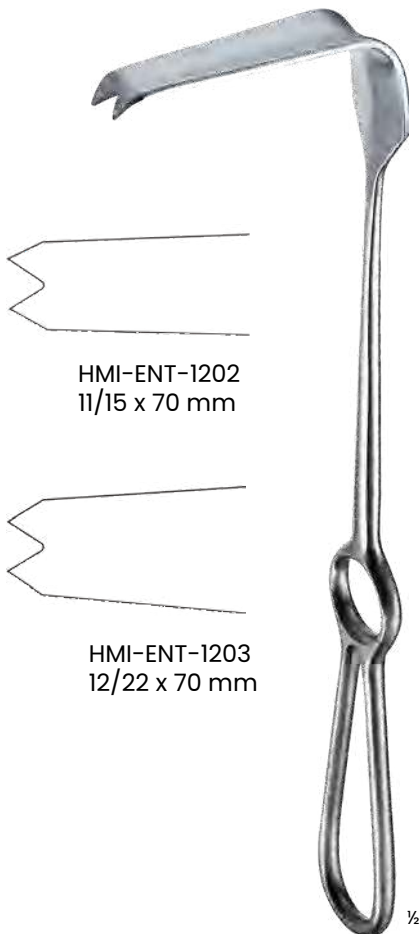

HMI-ENT-1202
 11/15 x 70 mm

HMI-ENT-1203
 12/22 x 70 mm

OBWEGESER
 24.5 cm/9¾"

Notched alveolar retractor

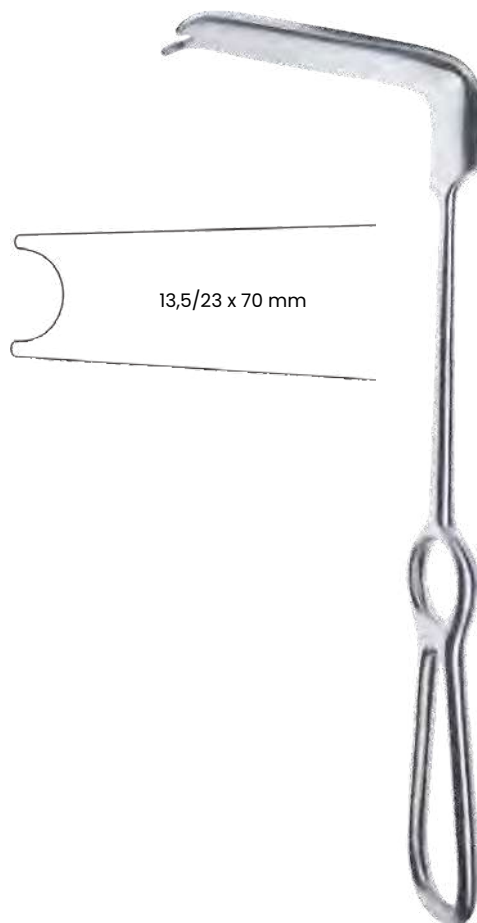

13,5/23 x 70 mm

OBWEGESER
 HMI-ENT-1204
 22 cm/9"

Nasal spine retractor

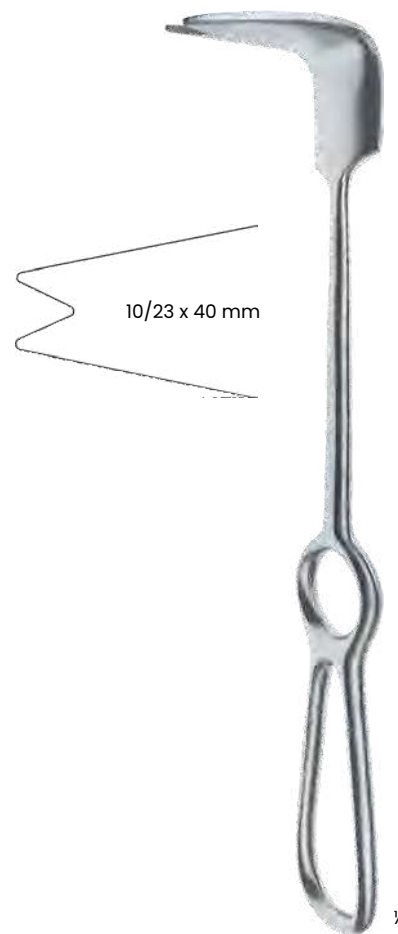

10/23 x 40 mm

OBWEGESER
 HMI-ENT-1205
 24.5 cm/9¾"

Let Us know if you could not find what you are looking for

Osteotomes for alveolar process

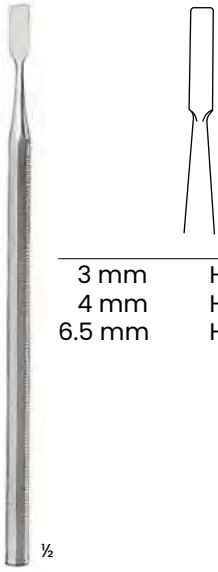

3 mm HMI-ENT-1206
 4 mm HMI-ENT-1207
 6.5 mm HMI-ENT-1208

OBWEGESER
 15.5 cm/6"



OBWEGESER
 17 cm/6 3/4"

convex / concave

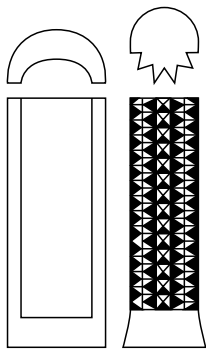

HMI-ENT-1212
 12 x 30 mm

Bone contouring forceps

1/2

Osteotomes

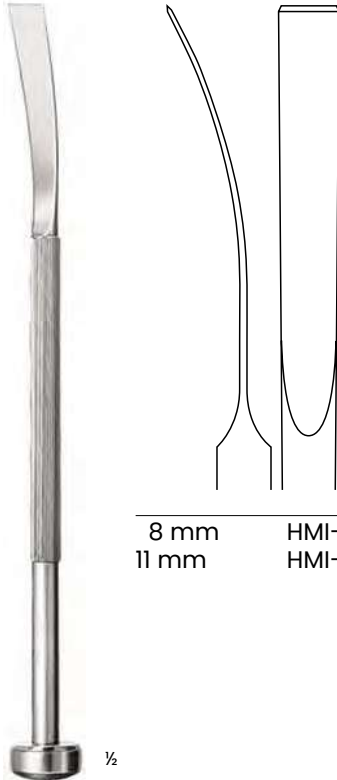

8 mm HMI-ENT-1200
 11 mm HMI-ENT-1210

OBWEGESER
 21 cm/8 1/4"



OBWEGESER
 17.5 cm/7"

concave / convex

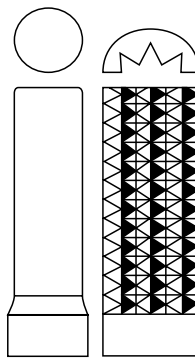

HMI-ENT-1213
 13.5 x 30 mm

Bone contouring forceps

1/2

Maxillary mobilizer

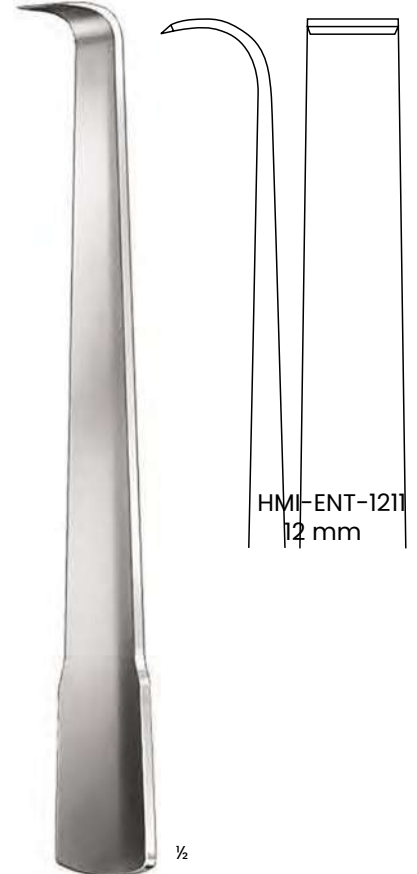

HMI-ENT-1211
 12 mm

OBWEGESER
 23 cm/9"



OBWEGESER
 17.5 cm/7"

flat / flat

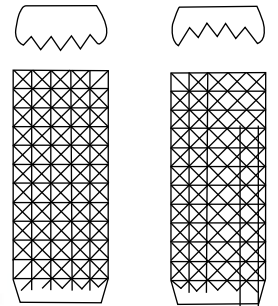

HMI-ENT-1214
 13.5 x 30 mm

Bone contouring forceps

1/2

Let Us know if you could not find what you are looking for

Extra oral Signotch Retractors

9,5 mm x 16 mm



½
 HMI-ENT-1215
 23 cm/10"

½
 HMI-ENT-1216
 23 cm/10"

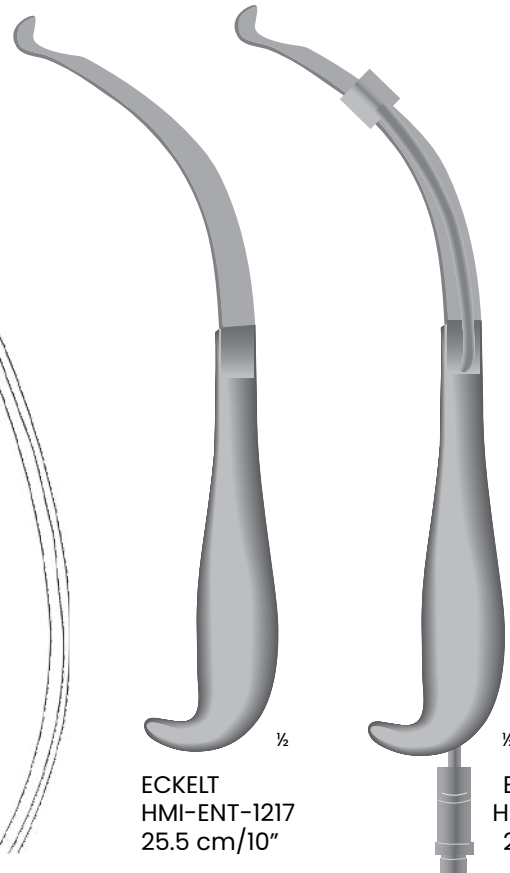

½
 ECKELT
 HMI-ENT-1217
 25.5 cm/10"

½
 ECKELT
 HMI-ENT-1218
 25.5 cm/10"

for right cheek

for left cheek

26,5 mm x 16 mm



½
 BAUER
 HMI-ENT-1219
 21 cm/8¼"

½
 BAUER
 HMI-ENT-1220
 21 cm/8¼"

for right cheek

for left cheek



½
 BAUER
 HMI-ENT-1221
 24.5 cm/9"

½
 BAUER
 HMI-ENT-1222
 24.5 cm/9"

Let Us know if you could not find what you are looking for

25,5 mm

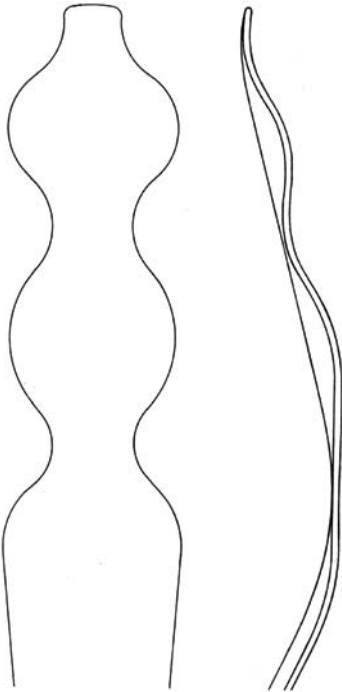

for LeFort osteotomies



½

PETRI-PTERYGOID
HMI-ENT-1223
23 cm/9"



½

PETRI-PTERYGOID
HMI-ENT-1224
23 cm/9"

12,5 mm / 27 mm

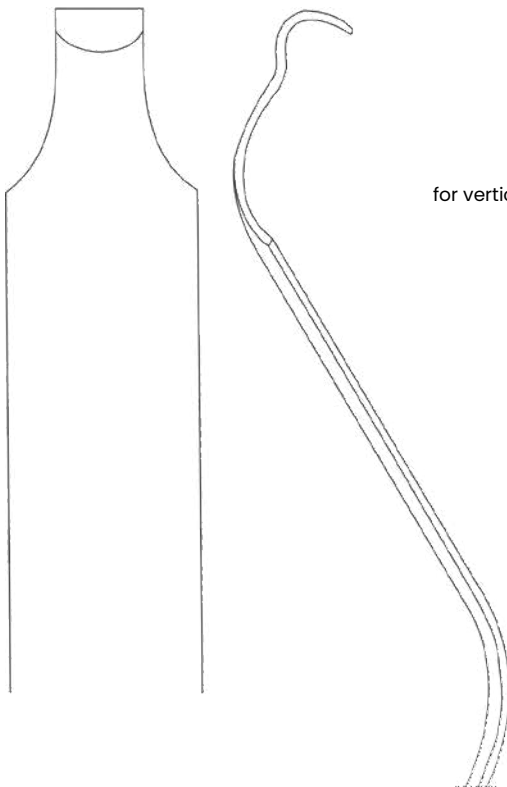

for vertical osteotomies



½

LEVASSEUR-MERRIL
HMI-ENT-1225
25 cm/9¾"



½

LEVASSEUR-MERRIL
HMI-ENT-1226
25 cm/9¾"



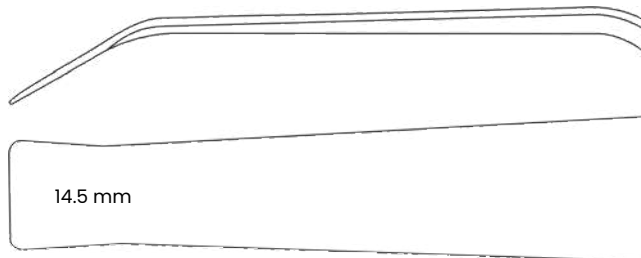

SHEA
 HMI-ENT-1227
 22 cm/8¾"

SHEA
 HMI-ENT-1228
 22 cm/8¾"

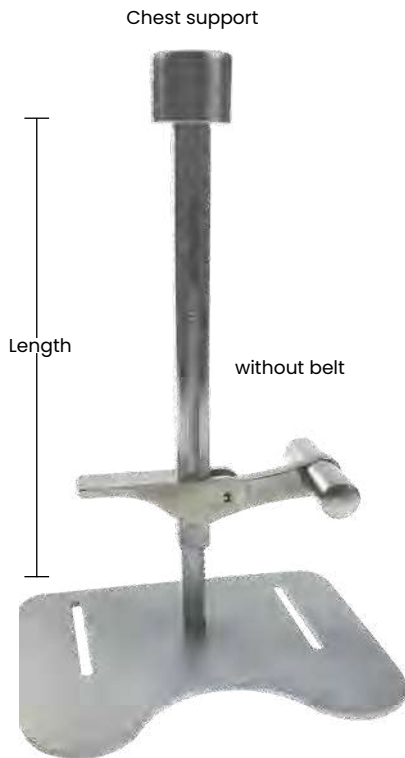

Length	NEGUS
85 mm	HMI-ENT-1229
140 mm	HMI-ENT-1230

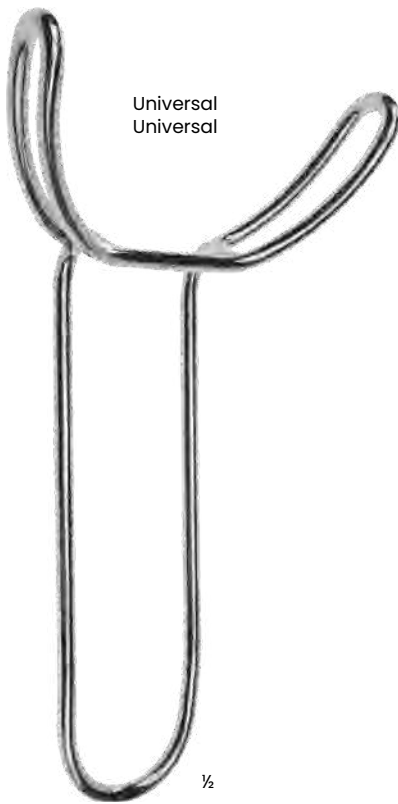

HMI-ENT-1231
 15 cm/6"



HMI-ENT-1232
 21 cm/8¼"

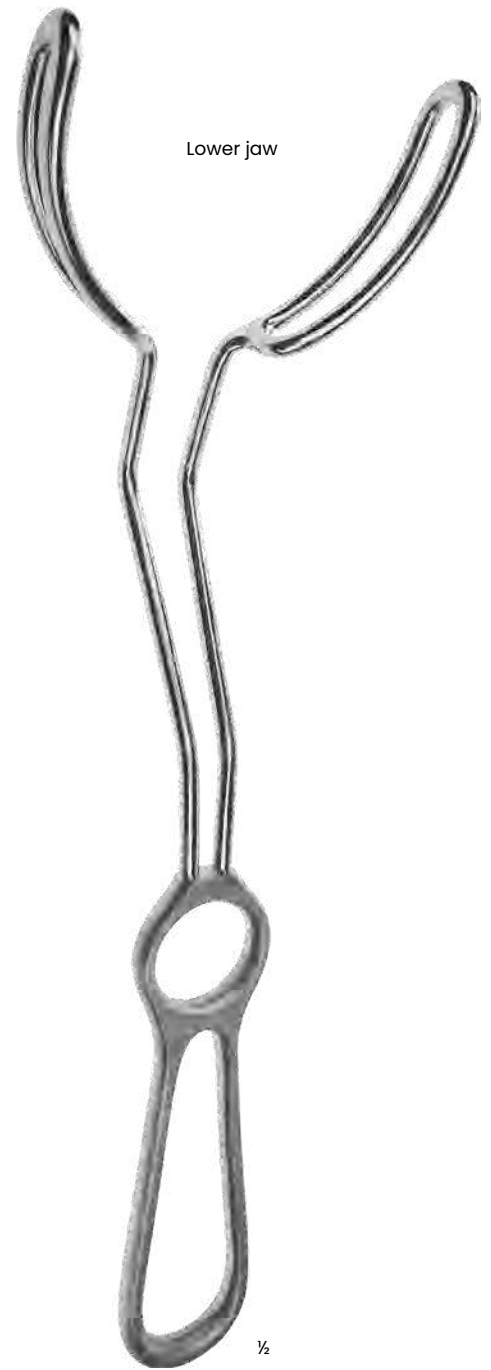

HMI-ENT-1233
 26 cm/10¼"

Let Us know if you could not find what you are looking for



Thank you for going through Catalog



www.healermedinstuments.com

Email: Healermedins@gmail.com

Whatsapp & Call: +92 3034515151