

**SURGICAL
INSTRUMENTS
CATALOG**



Whatsapp & Call: +92 3034515151

Medical staff Order online , While we offer Distributors
and businesses bulk orders with custom branding

sales@healermedinstruments.com
writetohealerm@gmail.com



Fractional Inches	Millimeters
1/16	1.588
1/8	3.175
3/16	4.736
1/4	6.350
5/16	7.938
3/8	9.525
7/16	11.113
1/2	12.700
9/16	14.288
5/8	15.875
11/16	17.463
3/4	19.050
13/16	20.638
7/8	22.225
15/16	23.813
1	25.400

Conversions:

Inches to Centimeters
 $cm = in \times 2.54$

Centimeters to Inches
 $in = cm \times 0.3937$

Millimeters to Inches
 $in = mm \times 0.03937$

Instrument Angles

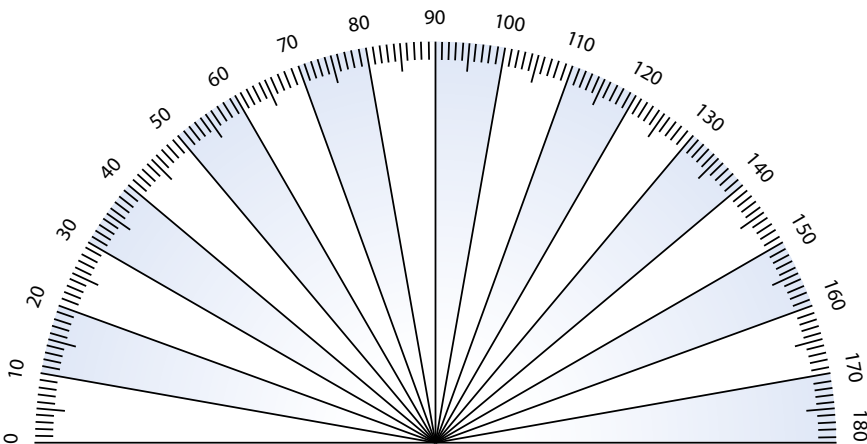

Conversion Scale		
To Convert From	To	Multiply
Ounces (AVDP.)	Grams	28.349523
Ounces (APOTH.)	Grams	31.103486
Grains	Grams	0.06479891
Pounds (AVDP.)	Kilograms	0.45359237
Inches	Centimeters	2.54
Feet	Meters	0.3048
Yards	Meters	0.9144
Ounces (U.S. Fluid)	Cubic Centimeters	29.573730
Ounces (British Fluid)	Cubic Centimeters	28.41305
Quarts (U.S. Fluid)	Liters	0.9463264
Cubic Inches	Cubic Centimeters	16.387064
Grams	Grains	15.432358
Grams	Ounces (AVDP.)	0.35273962
Grams	Ounces (APOTH.)	0.32150737
Kilograms	Pounds (AVDP.)	2.2046226
Millimeters	Inches	0.039370079
Centimeters	Inches	0.39370079
Meters	Feet	3.2808399
Cubic Centimeters	Cubic Inches	0.61023744
Cubic Centimeters (Fluid)	Ounces U.S. Fluid)	0.33814023
Liters	Quarts (U.S. Fluid)	1.056718

Fahrenheit and Centigrade Scales

F.	C.
500°	260°
400	205
392	200
383	195
374	190
356	180
347	175
338	170
329	165
320	160
311	155
302	150
284	140
275	135
266	130
248	120
239	115
230	110
212	100
203	95
194	90
176	80
167	75
140	60
122	50
113	45
105	40.56
104	40
100	37.8
98.5	36.9
95	35
86	30
77	25
68	20
50	10
41	5
32	0
23	-5
14	-10
+5	-15
-4	-20
-13	-25
-22	-30
-40	-40
-76	-60
1° F. = 5/9° C.	
1.8° F. = 1° C.	
3.6° F. = 2° C.	
4.5° F. = 2.5° C.	
5.4° F. = 3° C.	

Standard French:

The standard French or Charrière is used to measure diameters of all Bougies, Sounds, Catheters, Suction Tubes and Uterine Dilators.

Example:

12 Fr indicates a diameter of 4 mm

21 Fr indicates a diameter of 7 mm

French	3	4	5	6	7	8	9	10	11	12	13	14	15
American				4			6			8			10
	◦	◦	◦	○	○	○	○	○	○	○	○	○	○
	1 mm			2 mm			3 mm			4 mm		5 mm	

French	16	17	18	19	20	22	24	26	28	30	32	34
American			12				16			20		
	○	○	○	○	○	○	○	○	○	○	○	○
			6 mm				8 mm			10 mm		

French	36	38	40	42	44	45
American	24					30
	○	○	○	○	○	○
	12 mm					15 mm

* Chart is actual size

Illustration 1:

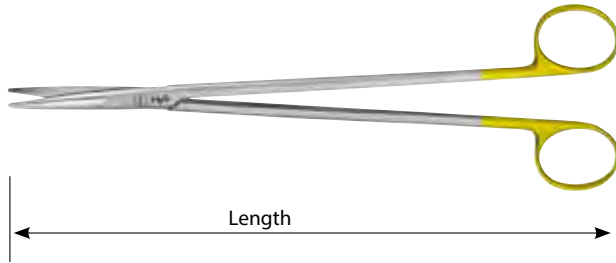

Illustration 2:

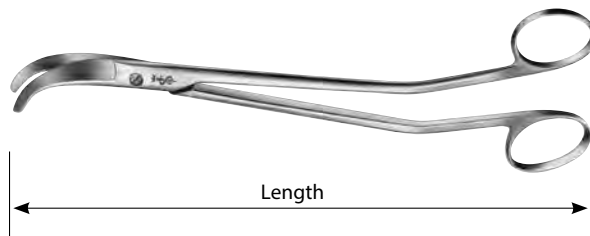

Illustration 3:

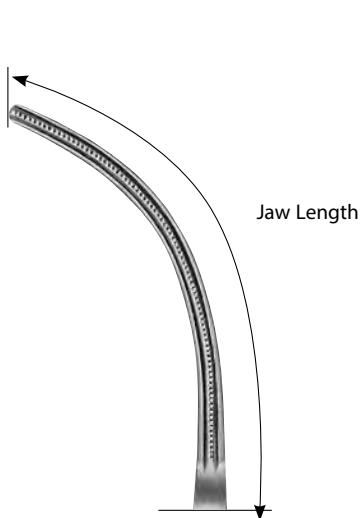

Illustration 4:

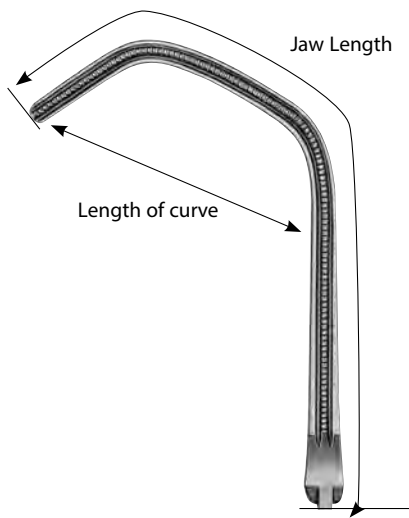

	Table of Contents	Page Number
GENERAL SURGERY	 <p>General Surgery</p>	1 - 326
CARDIO VASCULAR	 <p>Cardiovascular</p>	327 - 534
ENT EAR	 <p>ENT - EAR</p>	535 - 594
ENT NASAL	 <p>ENT - NASAL</p>	595 - 704
ENT ORAL	 <p>ENT - ORAL</p>	705 - 746
PLASTIC SURGERY	 <p>Plastic Surgery</p>	747 - 810
EYE	 <p>EYE</p>	811 -

Table of Contents	Page Number		
Orthopedics/Spine	879 - 1066		ORTHO
Neurosurgery	1067 - 1166		NEURO
Electrosurgery	1167 - 1200		ELECTRO
Obstetrics/Gynecology	1201 - 1296		OB/GYN
Urology	1297 - 1322		UROLOGY
Numerical Index	1323 - 1364		0 - 9
Alphabetical Index	1365 - 1394		A - Z

Let Us know if you could not find what you are looking for



General Surgery

Scissors	2 - 52
Needle Holders and Cases	53 - 76
Ligature Needles	77 - 78
Forceps and Clamps	79 - 189
Skin Hooks	190 - 192
Retractors	193 - 254
Universal Ring Retractor System	255 - 271
Self Retaining Retractors	272 - 283
Rectal Specula Instruments	284 - 291
Probes, Dilators and Scoops	292 - 299
Scalpel Blades and Handles	300 - 307
Amputation and Autopsy Instruments	308 - 310
Suction Instruments	311 - 322
Rulers, Calipers and Accessories	323 - 324
Metal Bowls and Cups	325



BC374R-BC474R

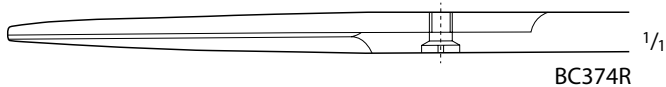

BC374R

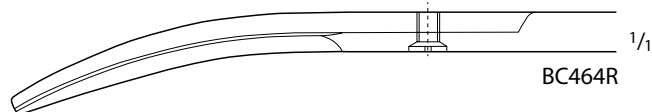

BC464R

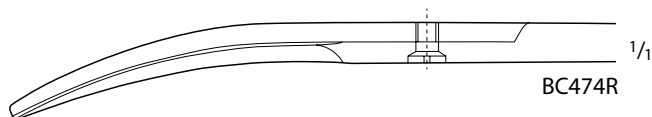

BC474R

DEAVER Suture Scissors

Catalog Number	Tip	Blade	Length (in.)
BC374R	S/B	STR	5 3/4
BC474R	S/B	CVD	5 3/4
BC464R	B/B	CVD	5 3/4

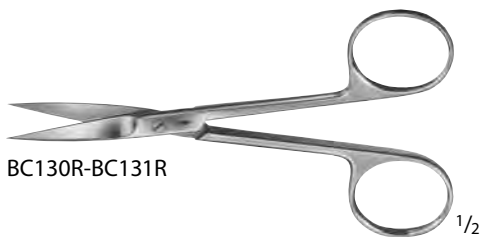

BC130R-BC131R

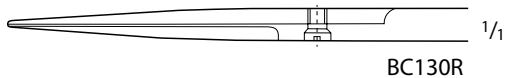

BC130R

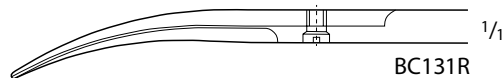

BC131R

Suture Scissors

Catalog Number	Tip	Blade	Length (in.)
BC130R	S/S	STR	4 3/4
BC341R	S/S	STR	4 1/2
BC343R	S/S	STR	5 1/8
BC344R	S/S	STR	5 3/4
BC345R	S/S	STR	6
BC346R	S/S	STR	6 1/2
BC131R	S/S	CVD	4 3/4



BC341R-BC346R

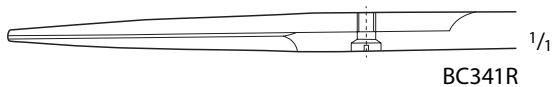

BC341R

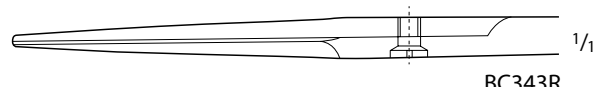

BC343R

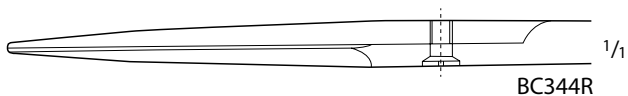

BC344R

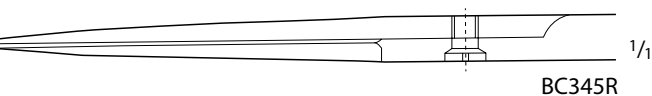

BC345R

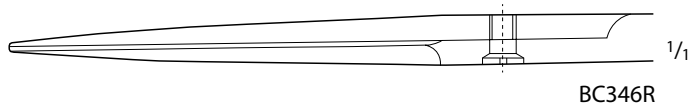

BC346R



BC441R-BC445R

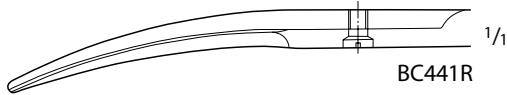

BC441R

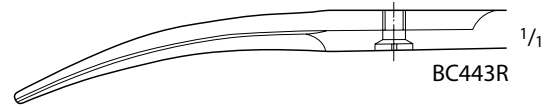

BC443R

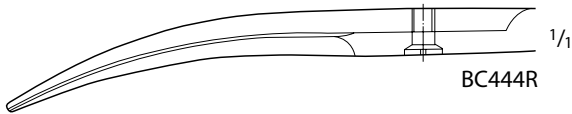

BC444R



BC445R

Suture Scissors

Catalog Number	Tip	Blade	Length (in.)
BC441R	S/S	CVD	4 1/2
BC443R	S/S	CVD	5 1/8
BC444R	S/S	CVD	5 3/4
BC445R	S/S	CVD	6



BC303R-BC304R

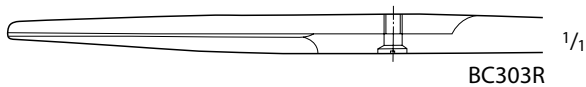

BC303R

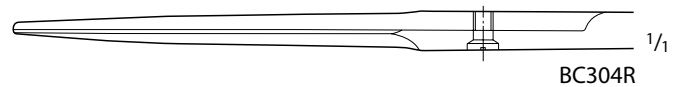

BC304R

Suture Scissors

Catalog Number	Tip	Blade	Length (in.)
BC303R	S/B	DEL, STR	5 1/8
BC304R	S/B	DEL, STR	5 3/4



BC496R

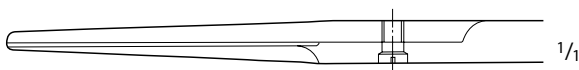

BC496R

Scissors

Catalog Number	Tip	Blade	Length (in.)
BC496R	S/B	STR/1-SERR	5 1/8



BC320R-BC330R



BC320R

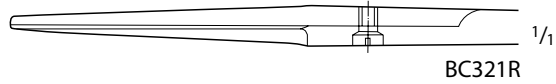

BC321R

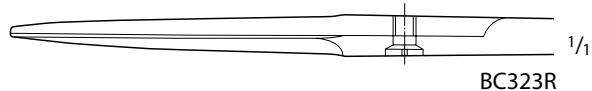

BC323R

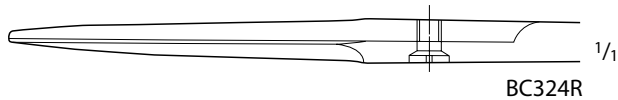

BC324R

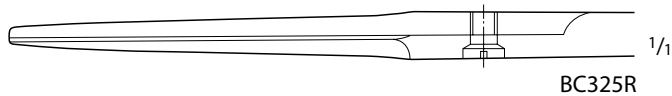

BC325R

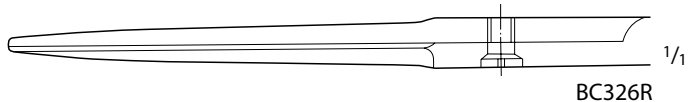

BC326R

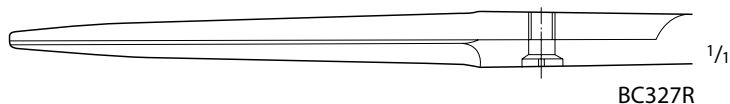

BC327R

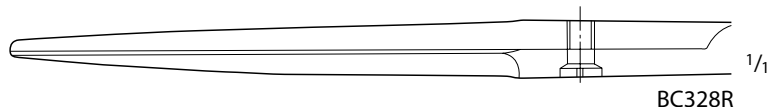

BC328R

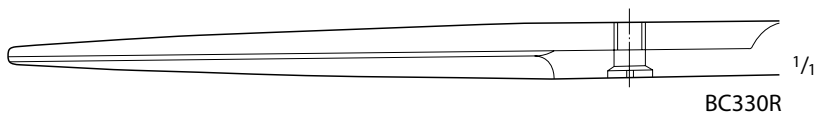

BC330R

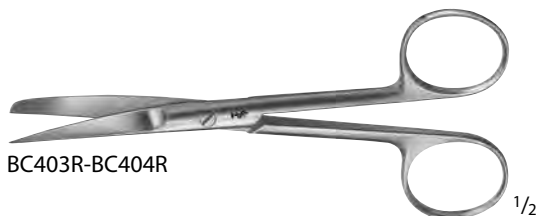

BC403R-BC404R

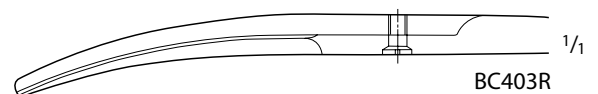

BC403R

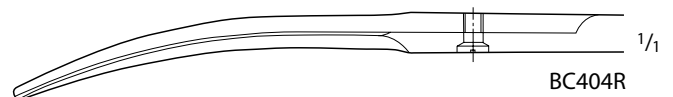

BC404R

Suture Scissors

Catalog Number	Tip	Blade	Length (in.)
BC320R	S/B	STR	4 1/8
BC321R	S/B	STR	4 1/2
BC323R	S/B	STR	5 1/8
BC324R	S/B	STR	5 3/4
BC325R	S/B	STR	6
BC326R	S/B	STR	6 1/2
BC327R	S/B	STR	6 7/8
BC328R	S/B	STR	7 1/4
BC330R	S/B	STR	7 7/8
BC403R	S/B	CVD	5 1/8
BC404R	S/B	CVD	5 3/4

Let Us know if you could not find what you are looking for

Suture Scissors

Catalog Number	Tip	Blade	Length (in.)
BC421R	S/B	CVD	4 1/2
BC423R	S/B	CVD	5 1/8
BC424R	S/B	CVD	5 3/4
BC425R	S/B	CVD	6
BC426R	S/B	CVD	6 1/2
BC428R	S/B	CVD	7 1/4



BC421R-BC428R

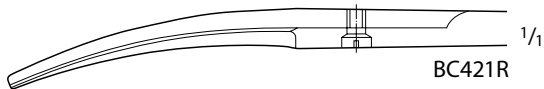

BC421R

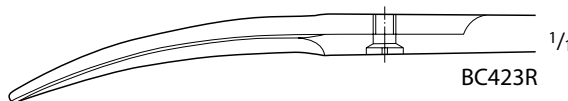

BC423R

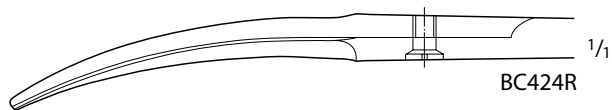

BC424R

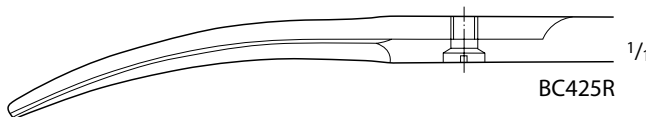

BC425R

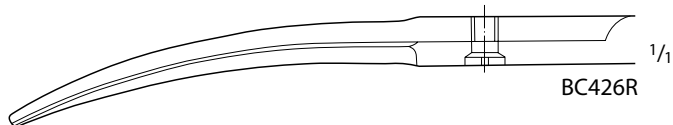

BC426R

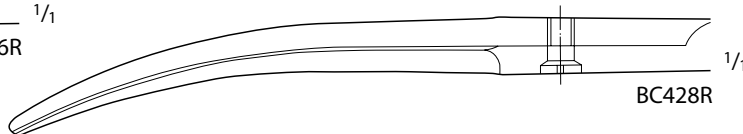

BC428R

Suture Scissors

Catalog Number	Tip	Blade	Length (in.)
BC135R	B/B	CVD, DEL	4 3/4



BC135R

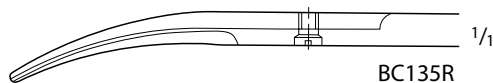

BC135R



BC313R-BC317R

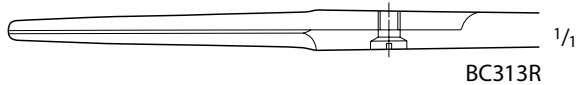

BC313R

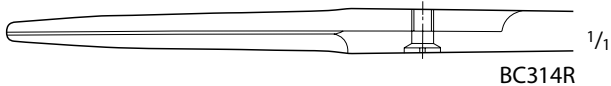

BC314R

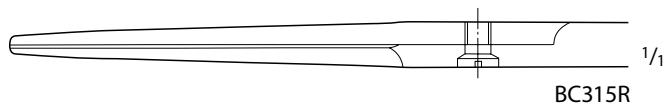

BC315R

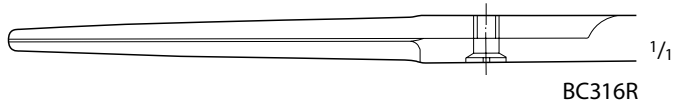

BC316R

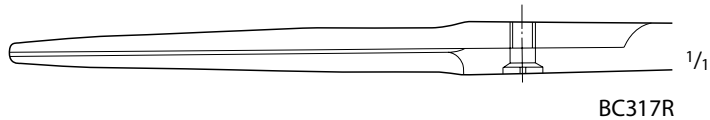

BC317R



BC411R-BC417R

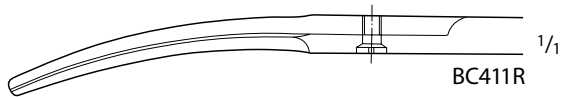

BC411R

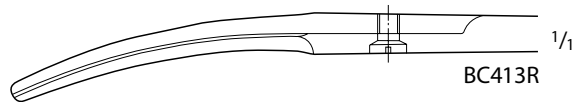

BC413R

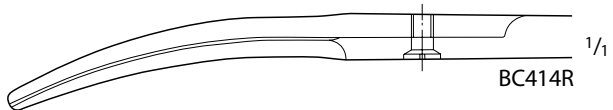

BC414R

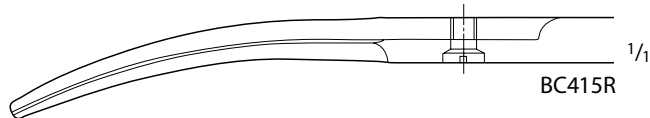

BC415R

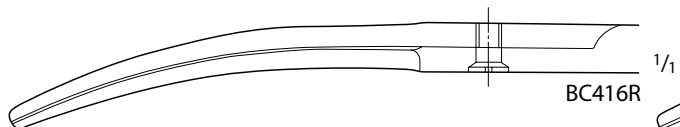

BC416R

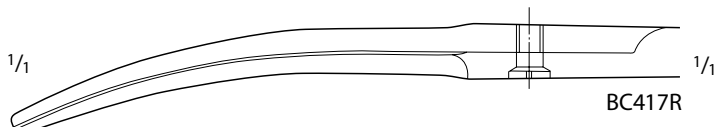

BC417R

COOPER Suture Scissors

Catalog Number	Tip	Blade	Length (in.)
BC313R	B/B	STR	5 1/8
BC314R	B/B	STR	5 3/4
BC315R	B/B	STR	6
BC316R	B/B	STR	6 1/2
BC317R	B/B	STR	6 7/8
BC411R	B/B	CVD	4 1/2
BC413R	B/B	CVD	5 1/8
BC414R	B/B	CVD	5 3/4
BC415R	B/B	CVD	6
BC416R	B/B	CVD	6 1/2
BC417R	B/B	CVD	6 7/8

Let Us know if you could not find what you are looking for

LITTAUER Ligature Scissors

Catalog Number	Tip	Blade	Length (in.)
BC803R	B/1-NOTCH	STR	5 1/4

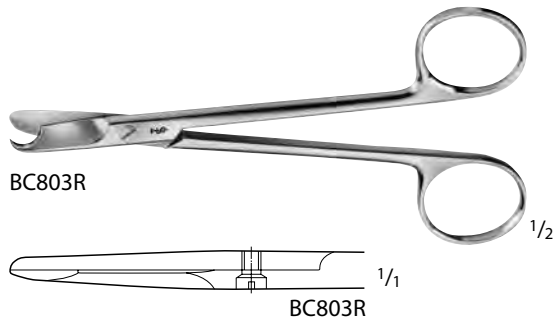

NORTHBENT Ligature Scissors

Catalog Number	Tip	Blade	Length (in.)
BC805R	B/1-NOTCH	LAT-CVD	4 3/4

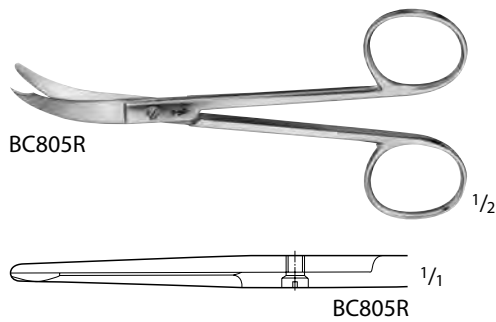

SPENCER Suture Scissors

Catalog Number	Tip	Blade	Length (in.)
BC801R	B/1-NOTCH	STR	3 1/2
BC802R	B/1-NOTCH	STR	4 1/2

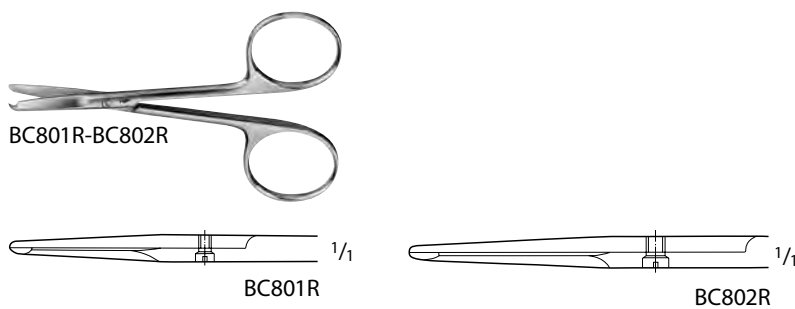

KNOWLES Bandage Scissors

Catalog Number	Tip	Blade	Length (in.)
BC846R	1-PROBE-POINT	STR	5 3/4
BC847R	1-PROBE-POINT	LAT-ANG	5 1/2

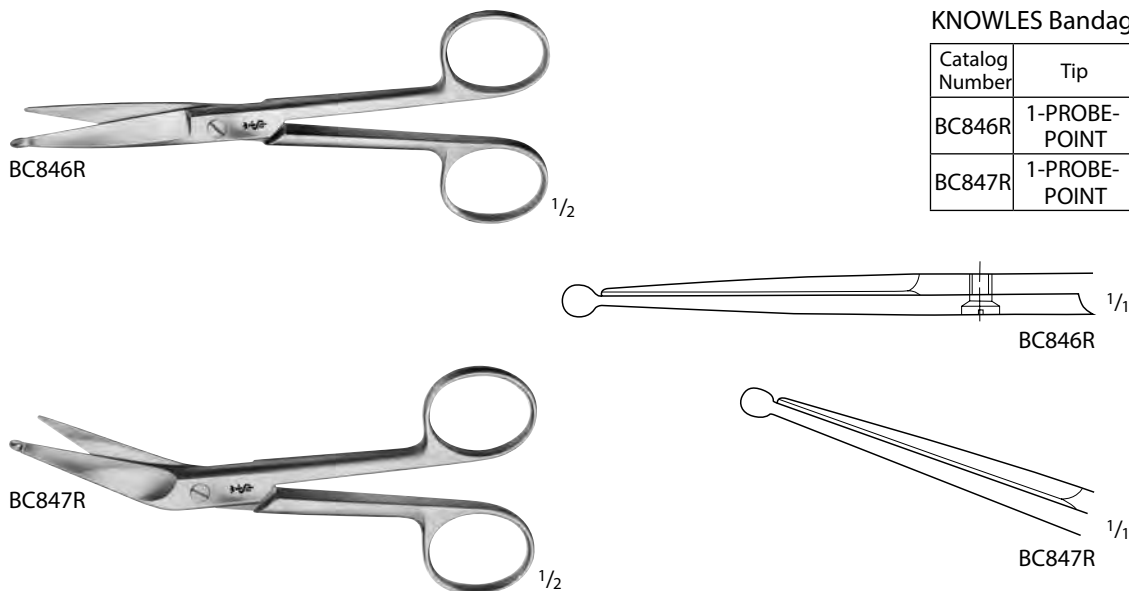



BC848R-BC863R

LISTER Bandage Scissors

Catalog Number	Blade	Length (in.)
BC848R	LONG	6 1/8
BC849R	LONG	7
BC860R	STANDARD	4 1/2
BC861R	STANDARD	5 1/2
BC862R	STANDARD	7
BC863R	STANDARD	7 7/8

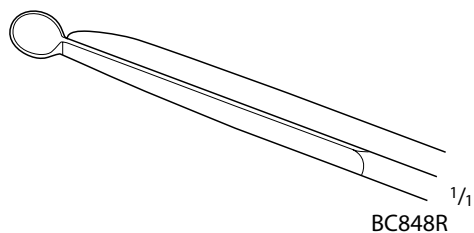

BC848R

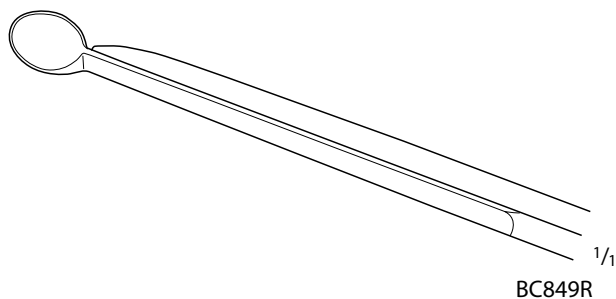

BC849R

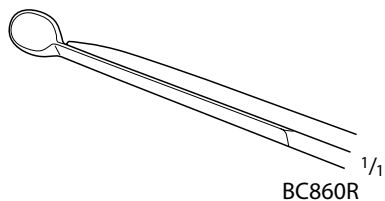

BC860R

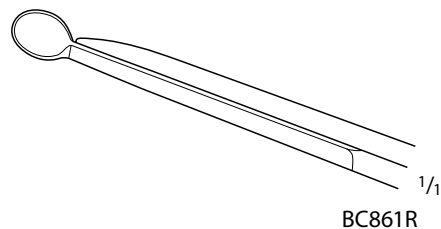

BC861R

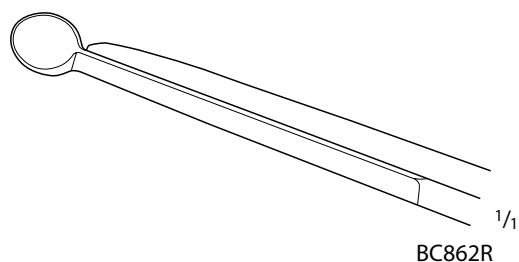

BC862R

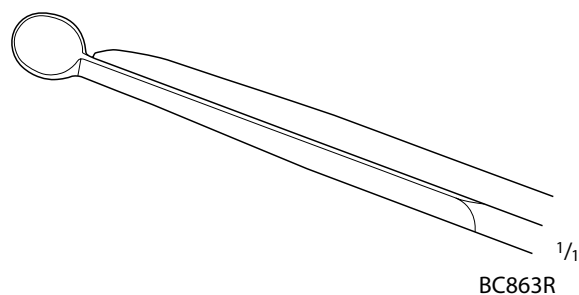

BC863R



MG379R

LISTER Bandage Scissors, Gold Handle

Catalog Number	Length (in.)
MG379R	5 1/2

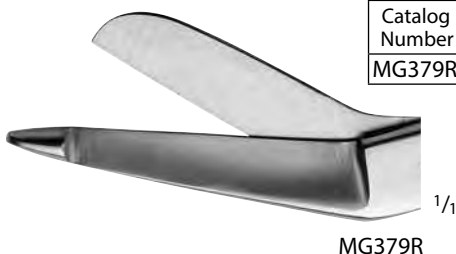

MG379R

LISTER Bandage Scissors, W/ One Large Ring

Catalog Number	Length (in.)
MB223	8



LISTER Bandage Scissors, Serrated

Catalog Number	Length (in.)
MB146R	3 1/2
BC876R	6 1/4

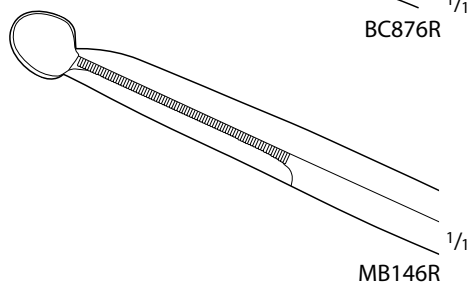
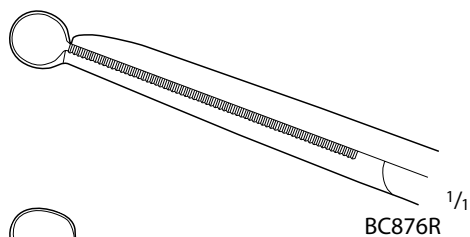



BC890R

1/2



BC890R

1/1



BC885R-BC979R

1/2

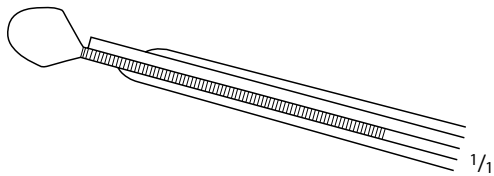

BC885R-BC979R

1/1



BC881R-BC989R

1/2

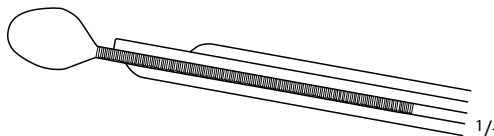

BC881R-BC989R

1/1

Nurse's Bandage Scissors

Catalog Number	Tip	Blade	Handle Color	Length (in.)
BC890R	B/B	STR	RED	5 3/4

LISTER Universal Bandage Scissors, Serrated

Catalog Number	Handle Color	Length (in.)
BC885R	BLACK	5 3/4
BC970R	RED	5 3/4
BC971R	BLUE	5 3/4
BC973R	YELLOW	5 3/4
BC975R	ORANGE	5 3/4
BC977R	PINK	5 3/4
BC978R	LIGHT GREEN	5 3/4
BC979R	VIOLET	5 3/4

Universal Bandage Scissors, W/ One Large Ring, Serrated

Catalog Number	Handle Color	Length (in.)
BC881R	BLACK	7
BC980R	RED	7
BC981R	BLUE	7
BC983R	YELLOW	7
BC985R	ORANGE	7
BC987R	PINK	7
BC988R	LIGHT GREEN	7
BC989R	VIOLET	7

STILLE Dissecting Scissors, Round Blades

Catalog Number	Tip	Blade	Length (in.)
BC580R	B/B	STR	6
BC581R	B/B	CVD	6



BC580R-BC581R

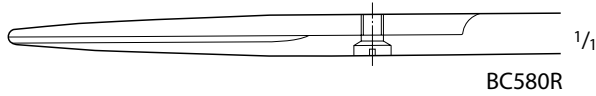

BC580R

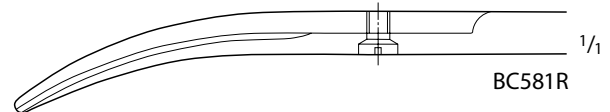

BC581R

MAYO Dissecting Scissors, Round Blade

Catalog Number	Tip	Blade	Length (in.)
BC584R	B/B	STR	6 1/2
BC585R	B/B	STR	7 7/8
BC587R	B/B	CVD	6 1/2
BC588R	B/B	CVD	7 7/8
BC589R	B/B	CVD	8 1/4



BC584R-BC589R

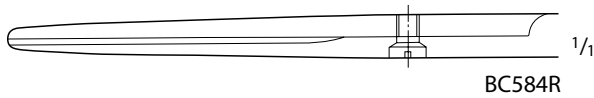

BC584R



BC587R

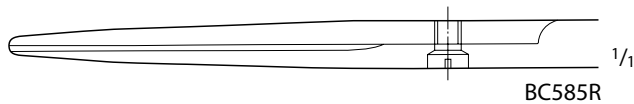

BC585R



BC588R

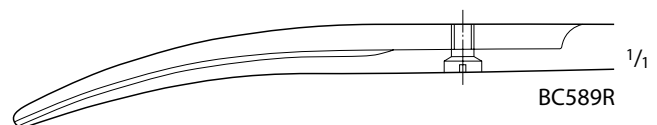

BC589R



BC560R-BC561R



BC560R



BC561R

MAYO-HARRINGTON Dissecting Scissors

Catalog Number	Tip	Blade	Length (in.)
BC560R	B/B	STR	9
BC561R	B/B	CVD	9

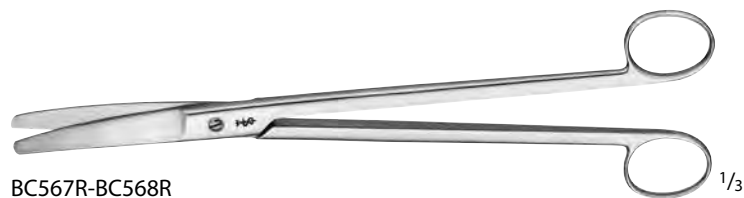

BC567R-BC568R

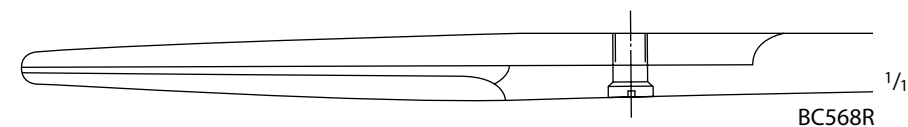

BC568R

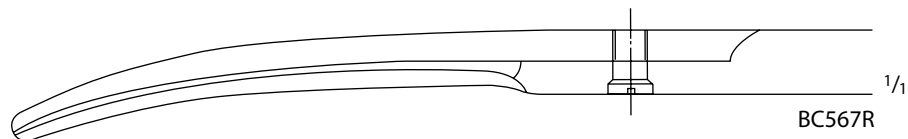

BC567R

MAYO-HARRINGTON Dissecting Scissors

Catalog Number	Tip	Blade	Length (in.)
BC568R	B/B	STR	11
BC567R	B/B	CVD	11

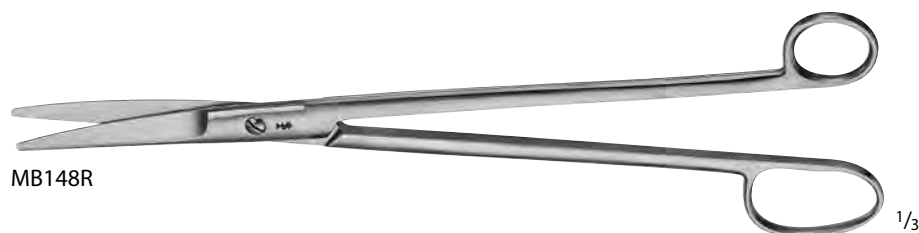

MB148R

MAYO Dissecting Scissors, W/ One Large Ring

Catalog Number	Tip	Blade	Length (in.)
MB148R	B/B	HEAVY	14

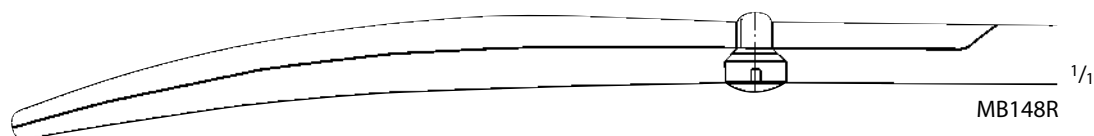

MB148R

MAYO Dissecting Scissors, Beveled Blade

Catalog Number	Tip	Blade	Length (in.)
BC544R	B/B	STR	5 1/2
BC545R	B/B	STR	6 1/8
BC547R	B/B	STR	6 3/4
BC562R	B/B	STR	7 1/2
BC564R	B/B	STR	8 1/2
BC554R	B/B	CVD	5 1/2
BC555R	B/B	CVD	6 1/8
BC557R	B/B	CVD	6 3/4
BC563R	B/B	CVD	7 1/2
BC565R	B/B	CVD	8 1/2

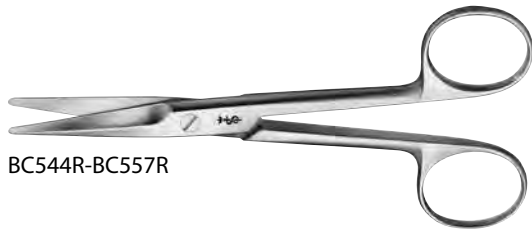

BC544R-BC557R

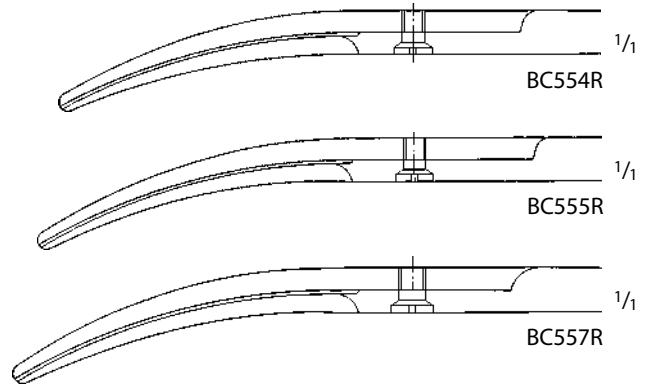
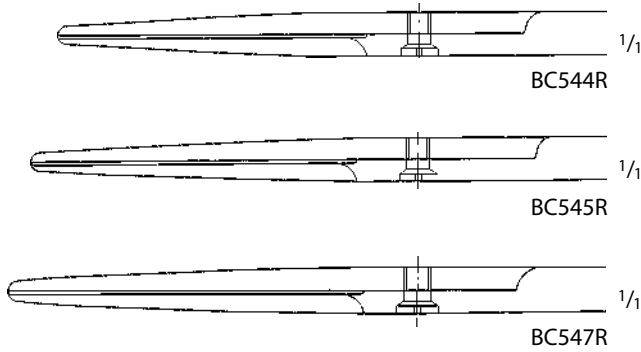

BC562R-BC565R

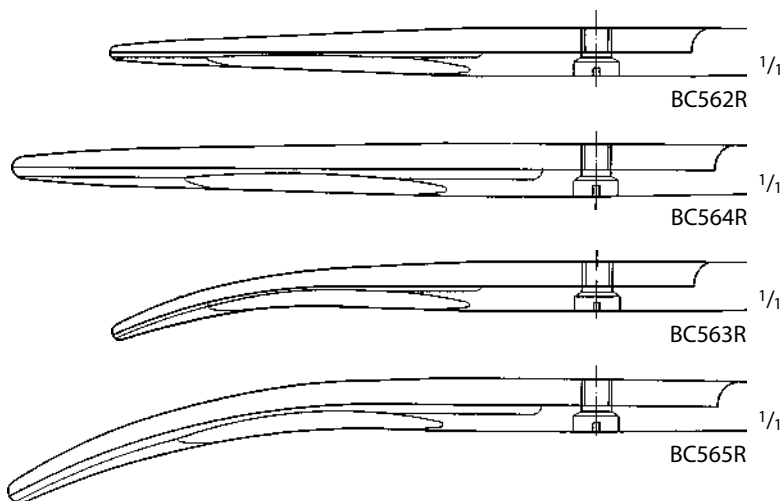



BC466R-BC467R



BC466R

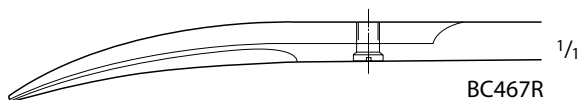

BC467R



BC594R

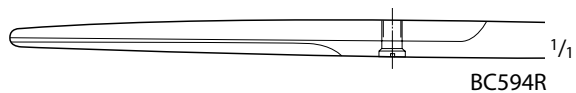

BC594R



BC804R

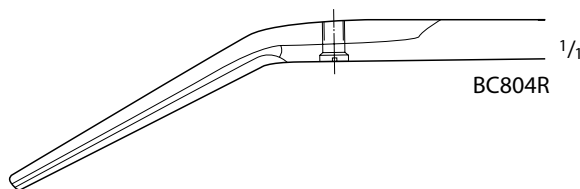

BC804R

MAYO Operating Scissors

Catalog Number	Tip	Blade	Length (in.)
BC466R	S/S	STR	5 1/2
BC467R	S/S	CVD	5 1/2

MAYO Dissecting Scissors, Delicate

Catalog Number	Tip	Blade	Length (in.)
BC594R	B/B	STR	5 1/2

NEW'S Suture Scissors

Catalog Number	Tip	Blade	Length (in.)
BC804R	B/B	ANG	5 1/2

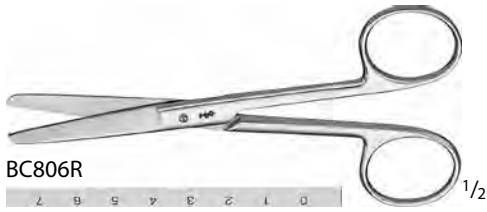

BC806R

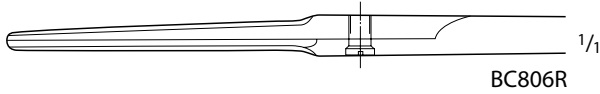

BC806R

Suture Scissors

Catalog Number	Tip	Blade	Length (in.)
BC806R	B/B	STR	4 1/2



BC590R-BC591R

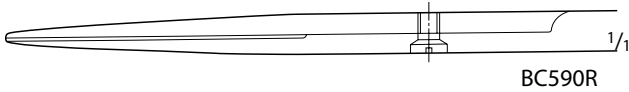

BC590R

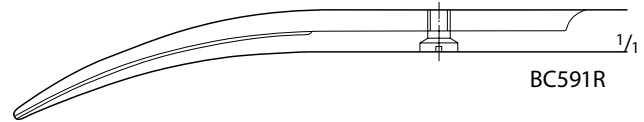

BC591R

LEXER Dissecting Scissors, Delicate

Catalog Number	Tip	Blade	Length (in.)
BC590R	B/B	STR	6 1/2
BC591R	B/B	CVD	6 1/2



BC592R

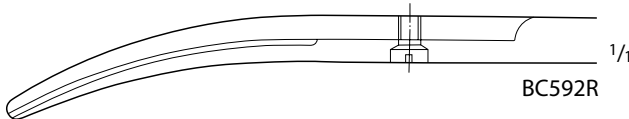

BC592R

MAYO-LEXER Dissecting Scissors

Catalog Number	Tip	Blade	Length (in.)
BC592R	B/B	CVD	6 1/2



MB149R

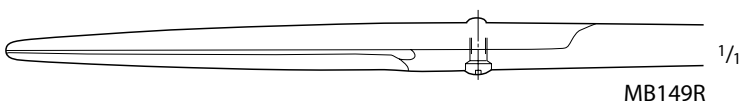

MB149R

MAYO-SIMS Dissecting Scissors

Catalog Number	Tip	Blade	Length (in.)
MB149R	B/B	STR	7 3/4



BC566R-BC569R

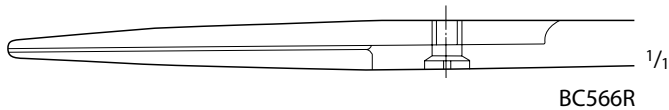

BC566R

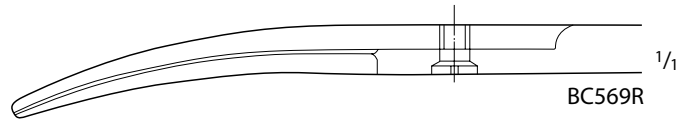

BC569R

MAYO-NOBLE Dissecting Scissors, Broad Blade

Catalog Number	Tip	Blade	Length (in.)
BC566R	B/B	STR	6 3/4
BC569R	B/B	CVD	6 3/4



BC576R-BC579R

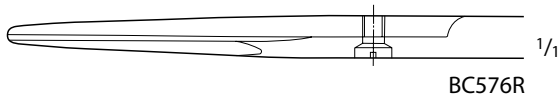

BC576R



BC577R

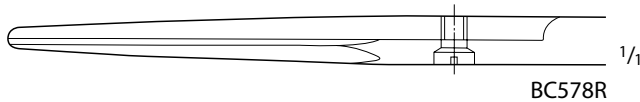

BC578R

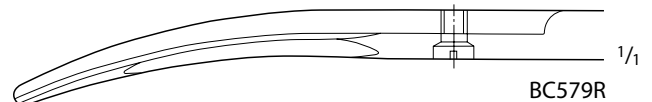

BC579R

MAYO-STILLE Dissecting Scissors, Beveled Blade

Catalog Number	Tip	Blade	Length (in.)
BC576R	B/B	STR	5 1/2
BC578R	B/B	STR	6 1/2
BC577R	B/B	CVD	5 1/2
BC579R	B/B	CVD	6 1/2



BC570R-BC575R

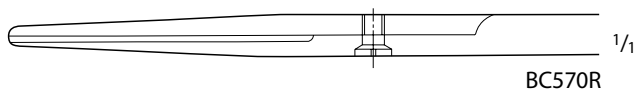

BC570R

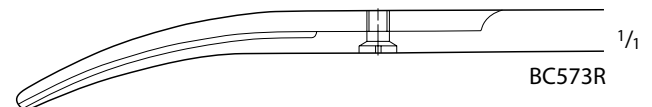

BC573R

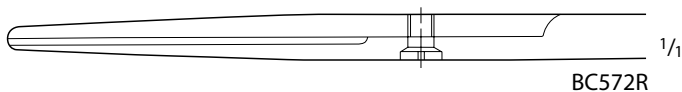

BC572R

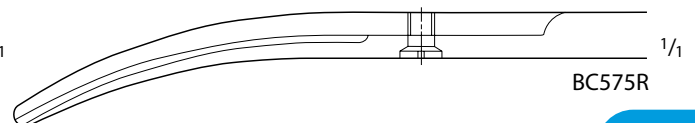

BC575R

MAYO-STILLE Dissecting Scissors, Flat Blade

Catalog Number	Tip	Blade	Length (in.)
BC570R	B/B	STR	5 1/2
BC572R	B/B	STR	6 3/4
BC573R	B/B	CVD	5 1/2
BC575R	B/B	CVD	6 3/4

TOENNIS Dissecting Scissors

Catalog Number	Tip	Blade	Length (in.)
BC633R	B/B	X-DEL, STR	7
BC634R	B/B	DEL, STR	7
BC635R	B/B	DEL, CVD	7

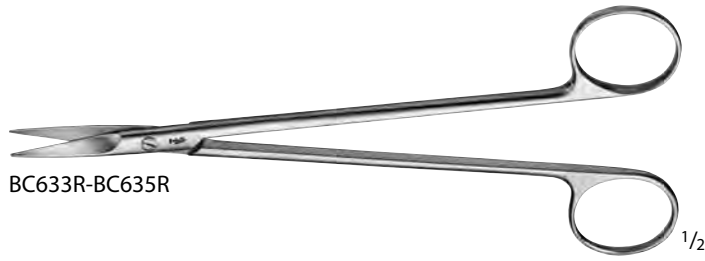

BC633R-BC635R

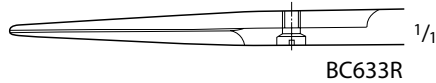

BC633R



BC635R

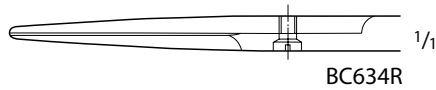

BC634R

Nerve Dissecting Scissors

Catalog Number	Tip	Blade	Length (in.)
BC628R	S/S	CVD	6

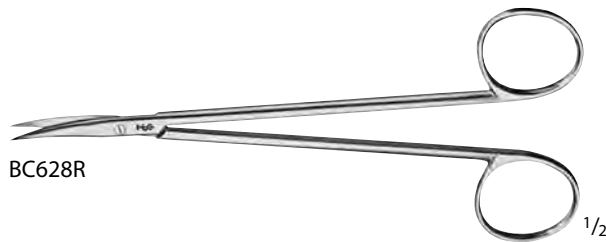

BC628R

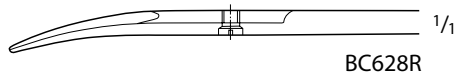

BC628R

TOENNIS-ADSON Dissecting Scissors

Catalog Number	Tip	Blade	Length (in.)
BC630R	X-DEL	CVD	6 7/8
BC631R	DEL	CVD	6 7/8

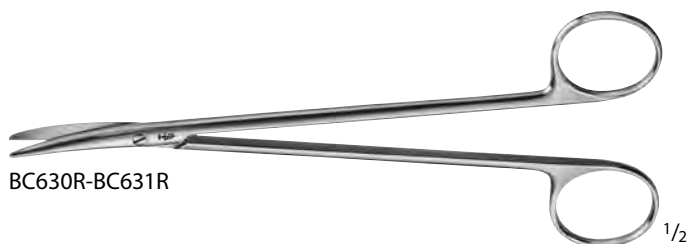

BC630R-BC631R

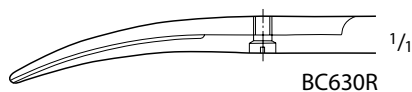

BC630R

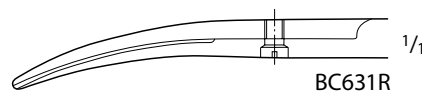

BC631R



BC601R-BC607R

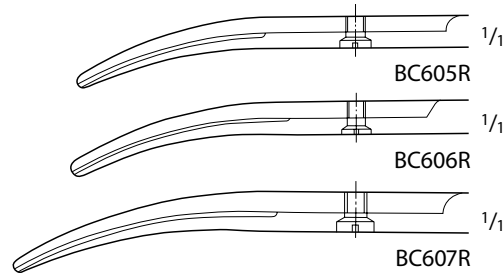
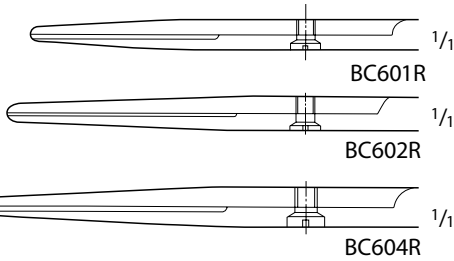

METZENBAUM Dissecting Scissors

Catalog Number	Tip	Blade	Length (in.)
BC601R	B/B	STR	5 3/4
BC602R	B/B	STR	7
BC604R	B/B	STR	7 7/8
BC605R	B/B	CVD	5 3/4
BC606R	B/B	CVD	7
BC607R	B/B	CVD	7 7/8



BC600R-BC603R

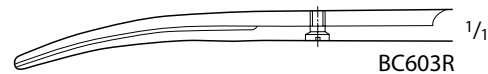
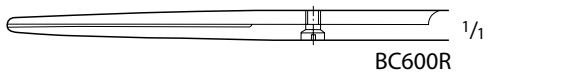

Baby METZENBAUM Dissecting Scissors, Delicate

Catalog Number	Tip	Blade	Length (in.)
BC600R	B/B	STR	5 3/4
BC603R	B/B	CVD	5 3/4



BC022R-BC023R

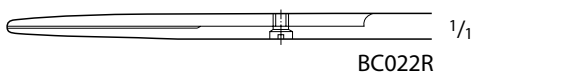

Baby METZENBAUM Dissecting Scissors

Catalog Number	Tip	Blade	Length (in.)
BC022R	B/B	STR	5 3/4
BC023R	B/B	CVD	5 3/4



MA464R-MA465R

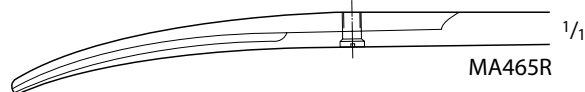

METZENBAUM Scissors, Delicate

Catalog Number	Tip	Blade	Length (in.)
MA464R	B/B	CVD	5 1/2
MA465R	B/B	CVD	8

NELSON-METZENBAUM Dissecting Scissors

Catalog Number	Tip	Blade	Length (in.)
BC611R	B/B	STR	9
BC612R	B/B	STR	9 3/4
BC613R	B/B	STR	11 1/4
BC614R	B/B	STR	12
BC615R	B/B	CVD	9
BC616R	B/B	CVD	9 3/4
BC618R	B/B	CVD	11 1/4
BC619R	B/B	CVD	12
MB926R	B/B	CVD	16

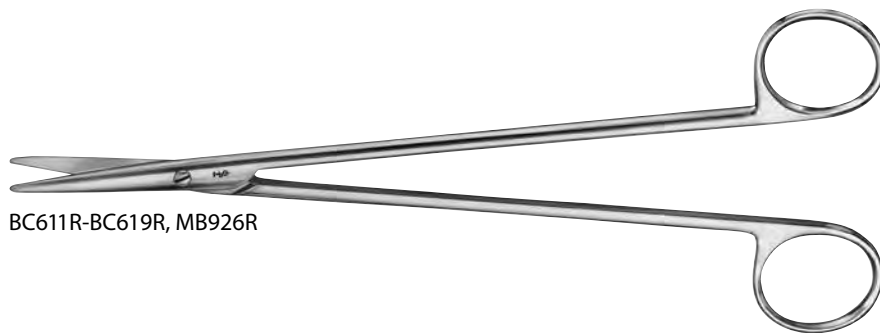

BC611R-BC619R, MB926R

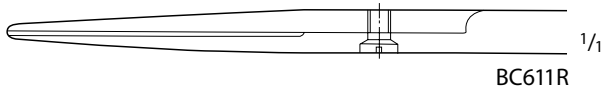

BC611R

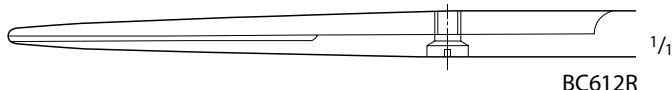

BC612R

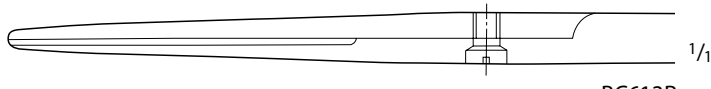

BC613R

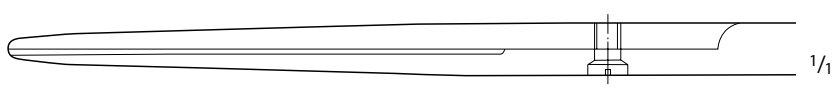

BC614R

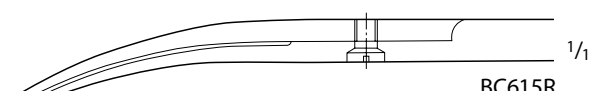

BC615R

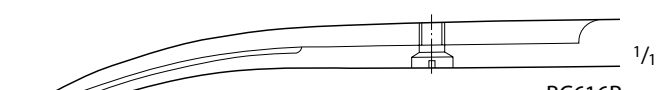

BC616R

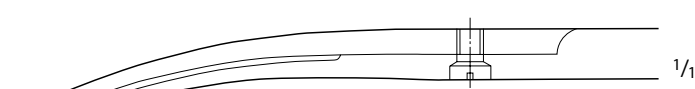

BC618R

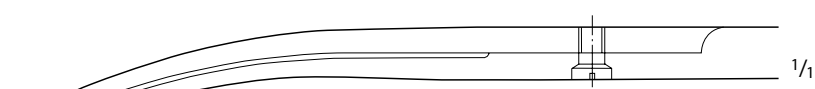

BC619R

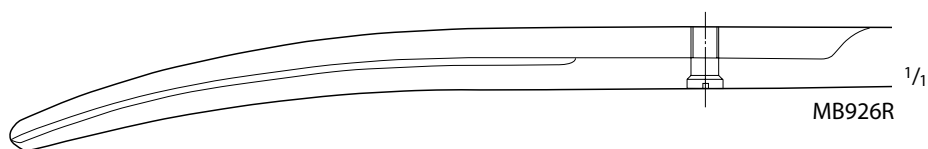

MB926R

NELSON-METZENBAUM Dissecting Scissors, Delicate

Catalog Number	Tip	Blade	Length (in.)
BC625R	B/B	CVD	13 3/4

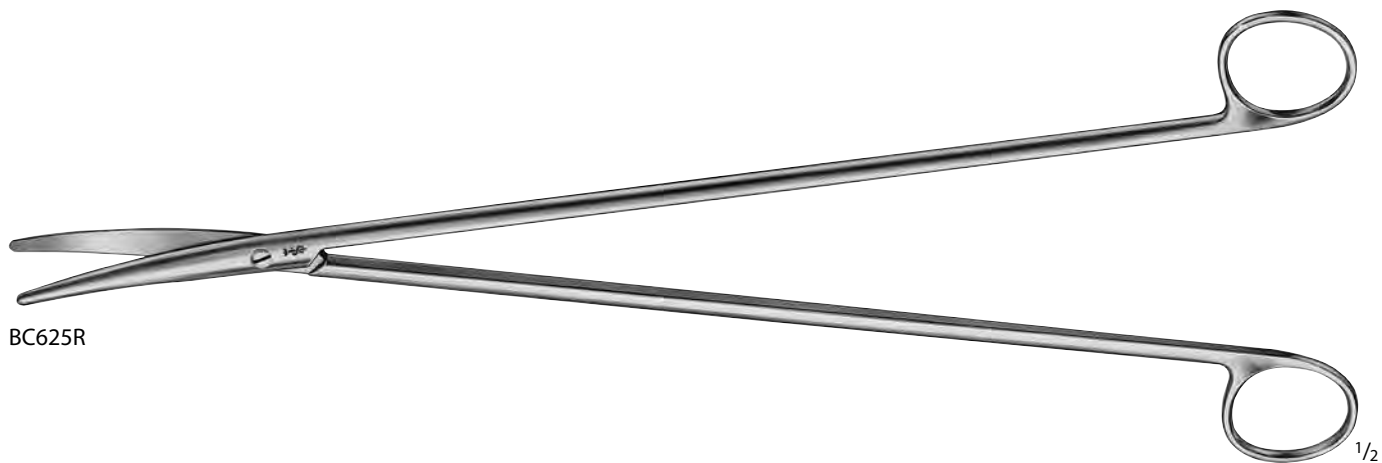

BC625R

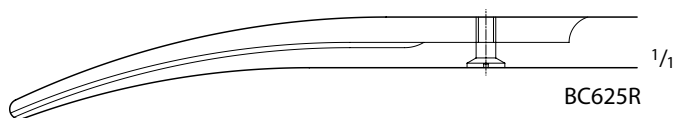

BC625R

WELLER Dissecting Scissors

Catalog Number	Tip	Blade	Length (in.)
BC620R	B/B	HEAVY-CVD	11

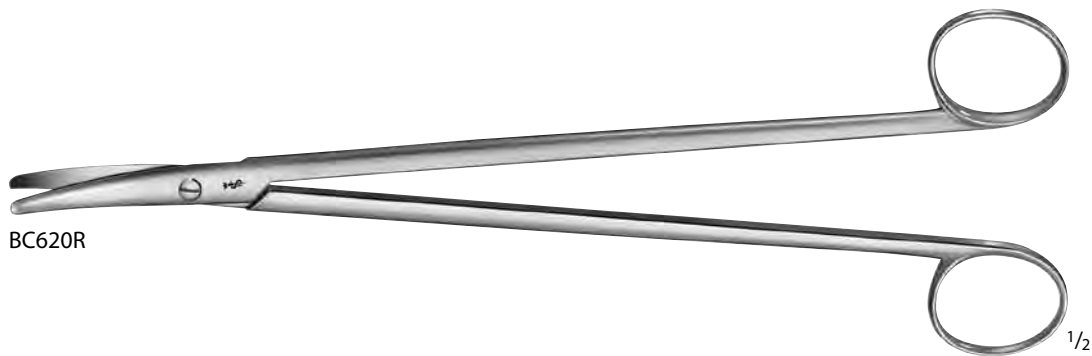

BC620R

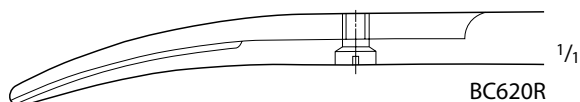

BC620R

Abdominal Scissors

Catalog Number	Tip	Blade	Length (in.)
BC774R	B/B	STR	7

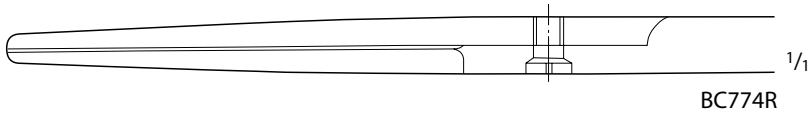

Rectal Scissors

Catalog Number	Tip	Blade	Length (in.)
BC617R	B/B	HEAVY-CVD	12 3/4

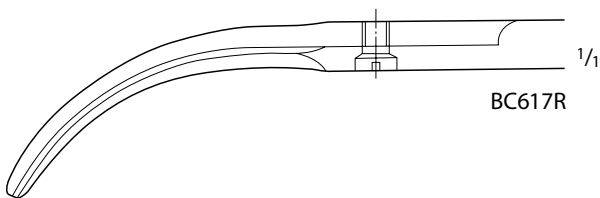
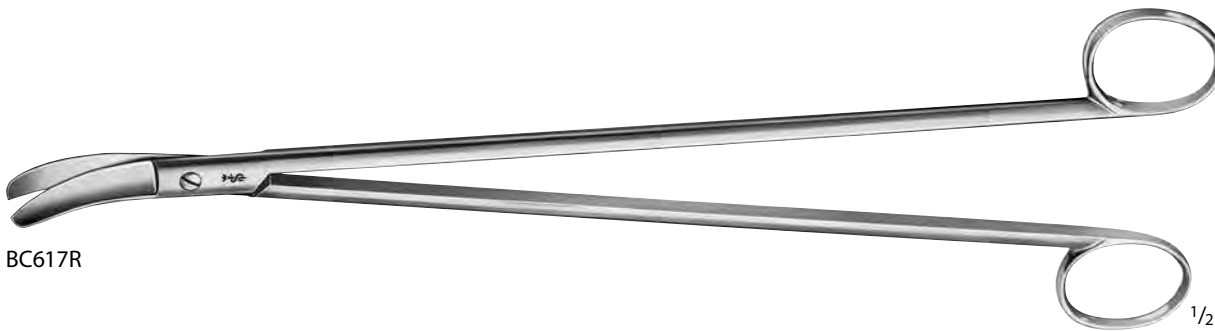

LLOYD-DAVIES Rectal Scissors

Catalog Number	Tip	Blade	Length (in.)
BC621R	B/B	CVD	10 5/8

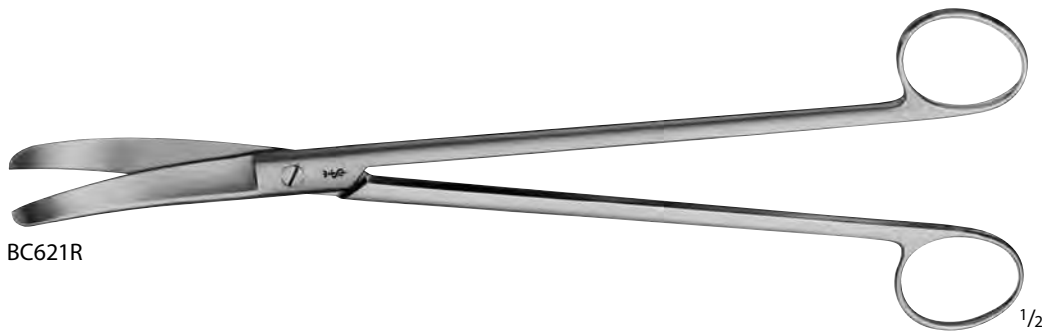

BC621R

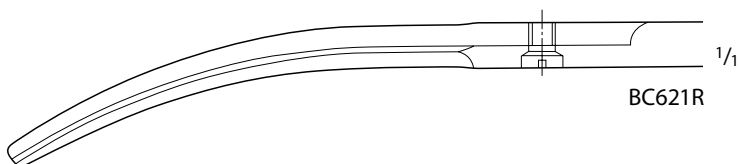

BC621R

STELZNER Rectal Scissors

Catalog Number	Tip	Blade	Length (in.)
BC622R	B/B	STR	12 1/4
BC623R	B/B	CVD	12 1/4

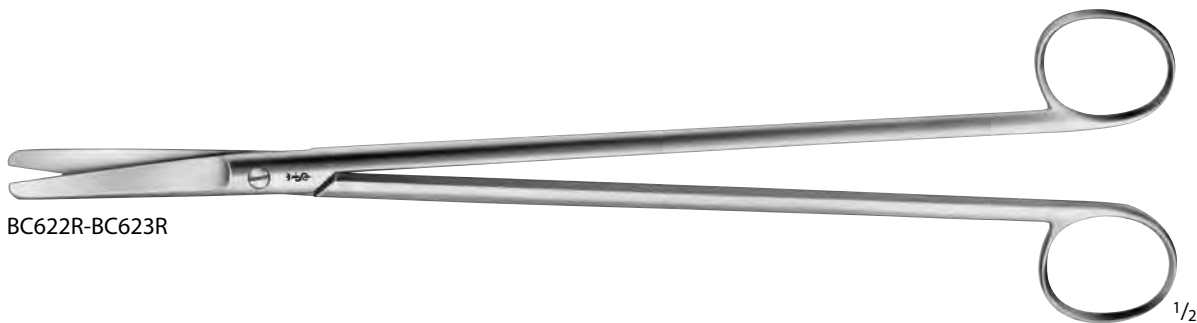

BC622R-BC623R

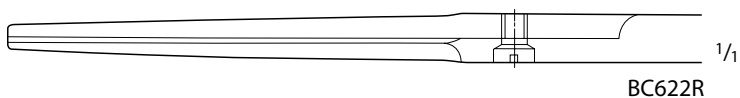

BC622R



BC623R

MUELLER Rectal Scissors

Catalog Number	Tip	Blade	Length (in.)
BC627R	B/B	CVD	12 3/4

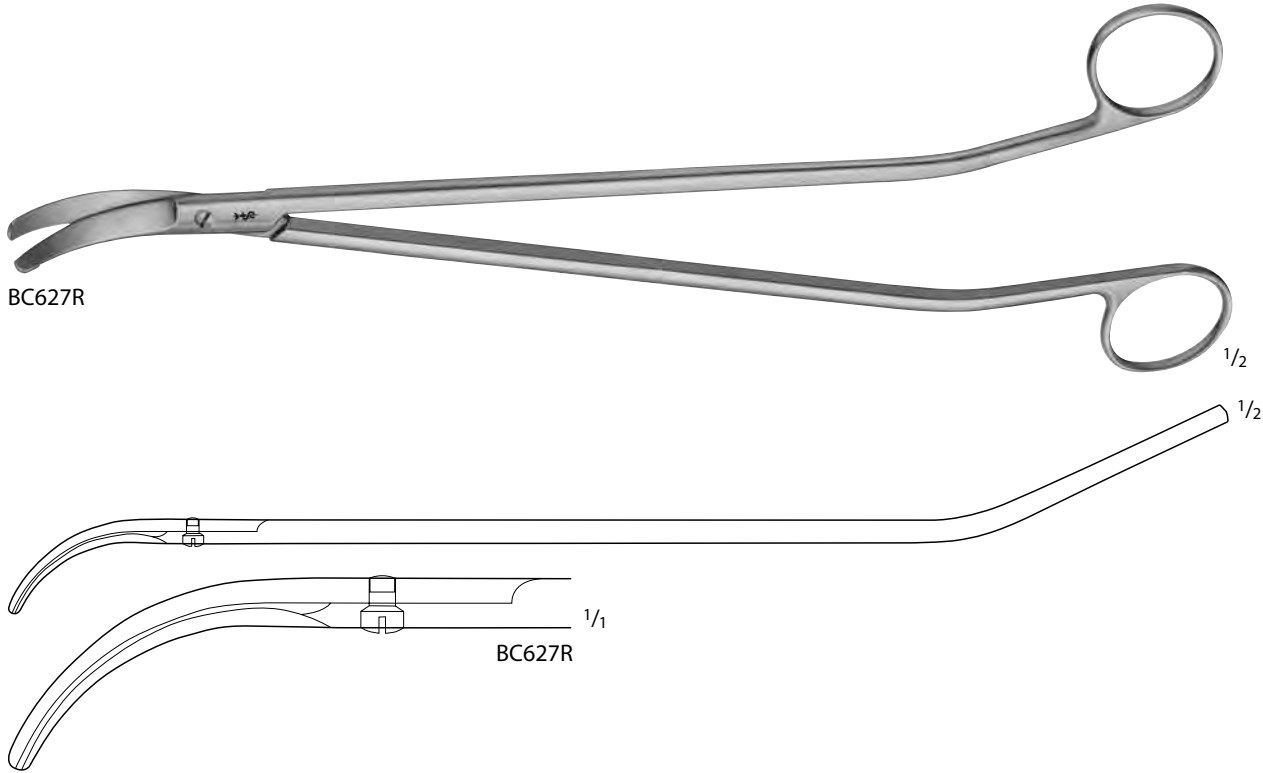

HARVEY Wire Scissors

Catalog Number	Tip	Blade	Length (in.)
BC815R	B/B	SERR	5

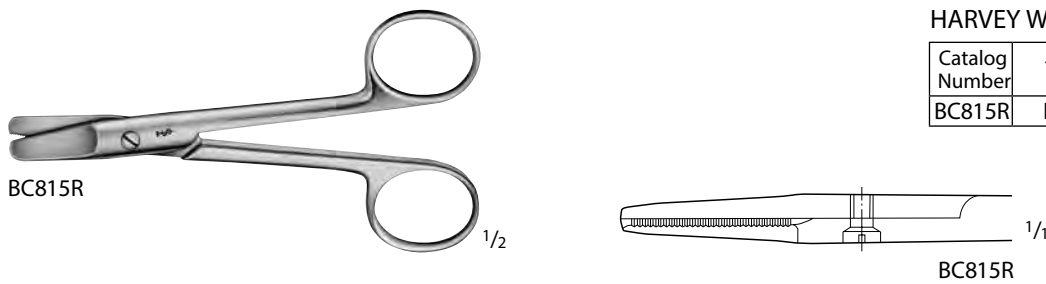

Wire Cutting Scissors

Catalog Number	For Wire Size	Length (in.)
DP551R	SOFT, UP TO 1.2MM AND HARD, UP TO 0.6 MM	4 3/4

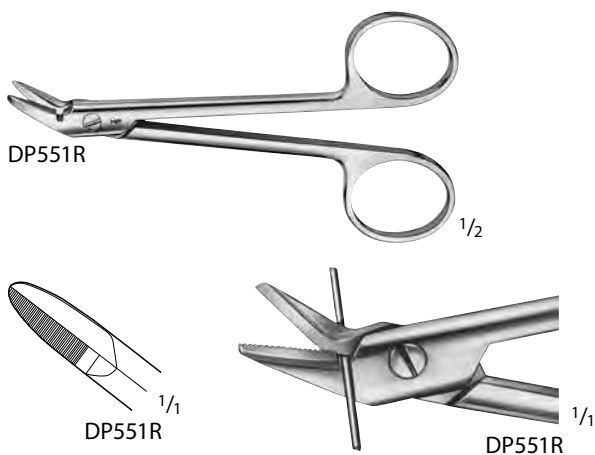

Iris Scissors

Catalog Number	Tip	Blade	Length (in.)
BC100R	S/S	STR	3 1/2
BC110R	S/S	STR	4 1/4
BC106R	S/S	STR	4 1/2
BC064R	S/S	STR	4 3/4
BC101R	S/S	CVD	3 1/2
BC111R	S/S	CVD	4 1/4
BC107R	S/S	CVD	4 1/2
BC065R	S/S	CVD	4 3/4
BC112R	S/B	STR	4 1/4
BC113R	S/B	CVD	4 1/4
BC117R	S/S	LAT-ANG	4 1/4

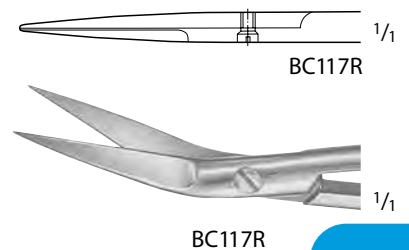
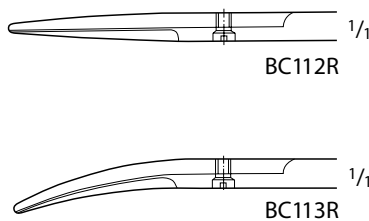
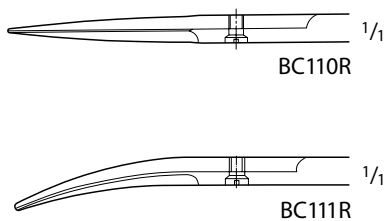
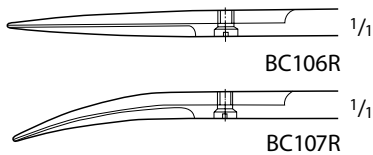
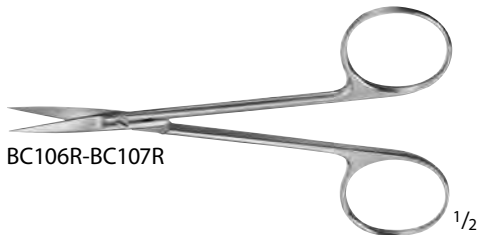
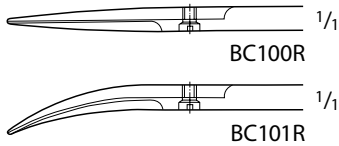
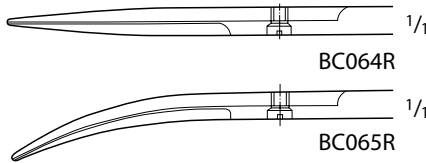

REYNOLDS-JAMESON Tenotomy Scissors

Catalog Number	Tip	Blade	Handle	Length (in.)
BC015R	B/B	CVD	SQUARE	5 1/2

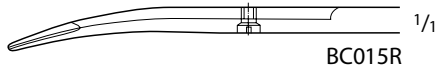
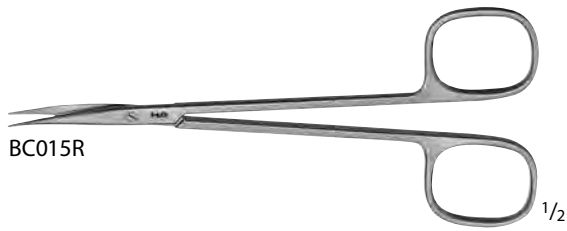

Strabismus Scissors

Catalog Number	Tip	Blade	Length (in.)
BC164R	B/B	STR	4 1/2
BC165R	B/B	CVD	4 1/2

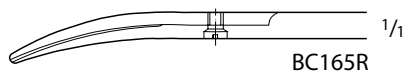
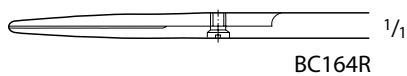

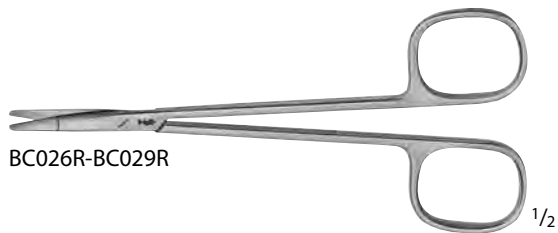

RAGNELL Dissecting Scissors

Catalog Number	Tip	Blade	Length (in.)
BC026R	B/B	STR	5 1/4
BC027R	B/B	CVD	5 1/4
BC029R	B/B	CVD	6

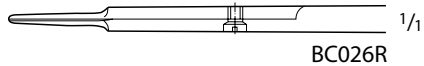

BC026R

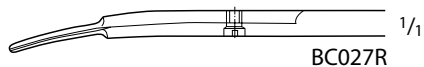

BC027R

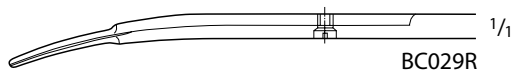

BC029R

CHADWICK Scissors, Delicate

Catalog Number	Tip	Blade	Length (in.)
BC153R	S/S	CVD	4 1/2

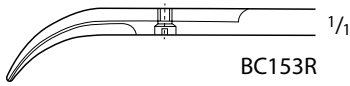

LA GRANGE Scissors

Catalog Number	Tip	Blade	Length (in.)
BC154R	S/S	1-SERR	4 1/4

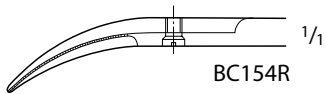

KELLY Scissors

Catalog Number	Tip	Blade	Length (in.)
BC160R	S/S	STR	6 7/8
BC161R	S/S	CVD	6 7/8

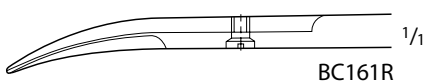
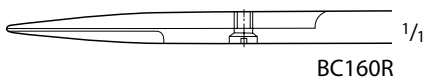
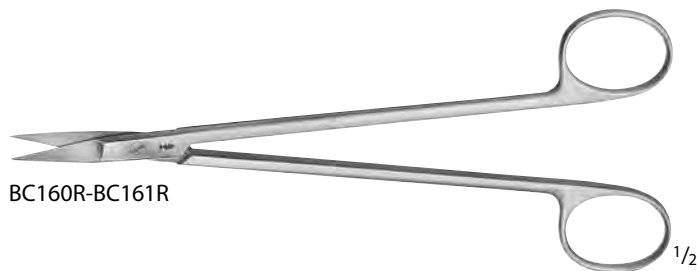

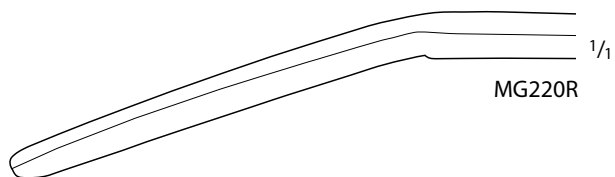

ROCHESTER-FERGUSON Scissors

Catalog Number	Tip	Blade	Length (in.)
MG220R	B/B	ANG FLAT	7

DUROTIP Tungsten Carbide Scissors

- Excellent cutting accuracy
- Long working life
- Gold-plated rings

DUROTIP TC Suture Scissors

Catalog Number	Tip	Blade	Length (in.)
BC228R	S/S	STR	5 3/4
BC224R	S/B	STR	5 3/4
BC234R	S/B	CVD	5 3/4

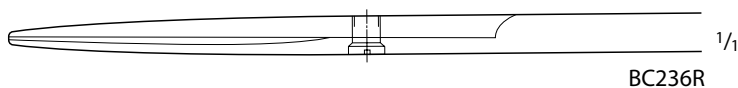
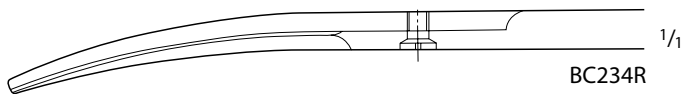
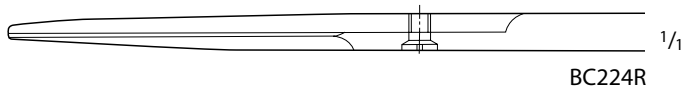
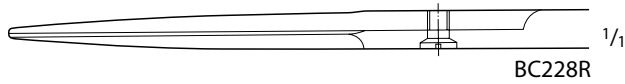

DUROTIP TC Operating Scissors

Catalog Number	Tip	Blade	Length (in.)
BC236R	S/S	STR	5 3/4
MB171R	S/S	CVD	5 3/4

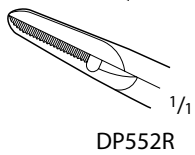
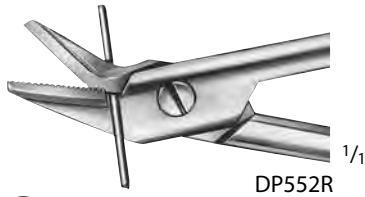
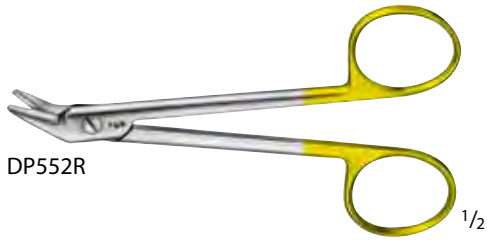

DUROTIP TC Wire Cutting Scissors

Catalog Number	Blade	For Wire Size	Length (in.)
DP552R	1-SERR	SOFT, UP TO 1.2 MM AND HARD, UP TO 0.8 MM	4 3/4

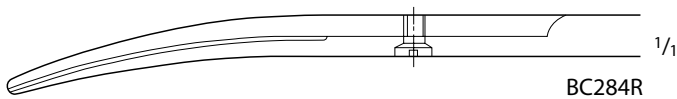

DUROTIP TC MAYO-LEXER Dissecting Scissors, Round Blades

Catalog Number	Tip	Blade	Length (in.)
BC284R	B/B	CVD	6 1/2



BC240R-BC243R

DURO TIP TC MAYO Dissecting Scissors, Round Blades

Catalog Number	Tip	Blade	Length (in.)
BC240R	B/B	STR	5 1/2
BC242R	B/B	STR	6 3/4
BC241R	B/B	CVD	5 1/2
BC243R	B/B	CVD	6 3/4

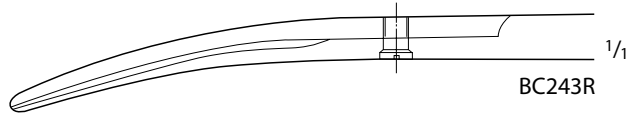
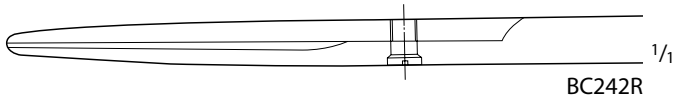
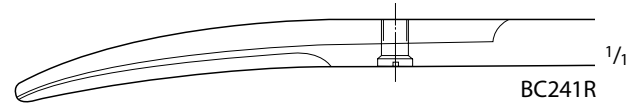
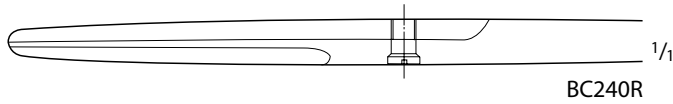

BC250R-BC253R

DURO TIP TC MAYO Dissecting Scissors, Beveled Blades

Catalog Number	Tip	Blade	Length (in.)
BC250R	B/B	STR	5 1/2
BC252R	B/B	STR	6 3/4
BC251R	B/B	CVD	5 1/2
BC253R	B/B	CVD	6 3/4

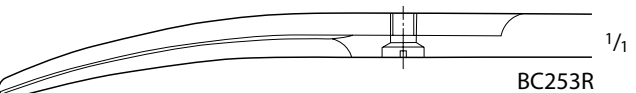
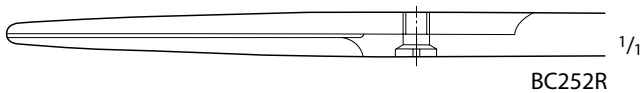
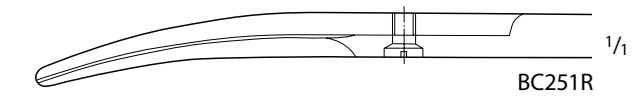
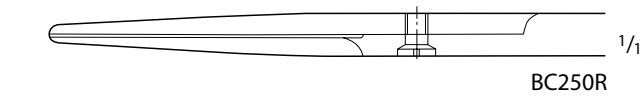



BC558R-BC559R, MB726R

DUROTIP TC MAYO Dissecting Scissors

Catalog Number	Tip	Blade	Length (in.)
BC558R	B/B	STR	9
MG215R	B/B	STR	14
BC559R	B/B	CVD	9
MB726R	B/B	CVD	14

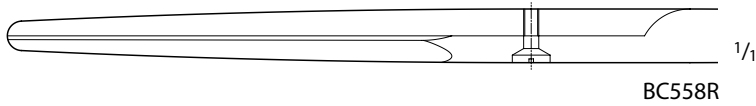

BC558R

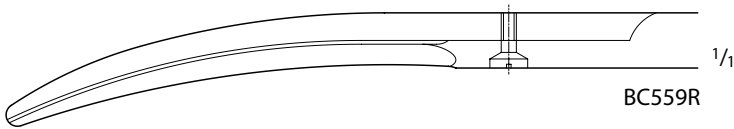

BC559R

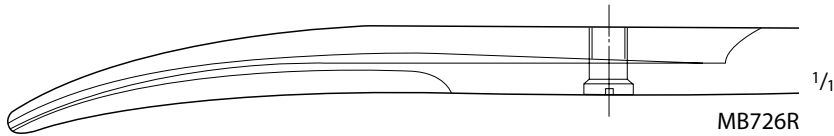

MB726R



MG215R

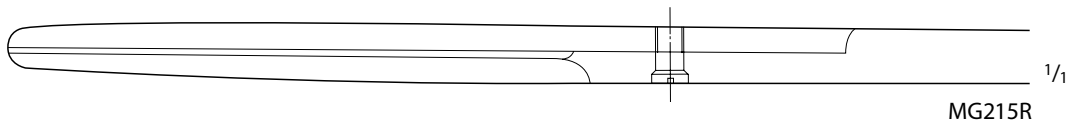

MG215R

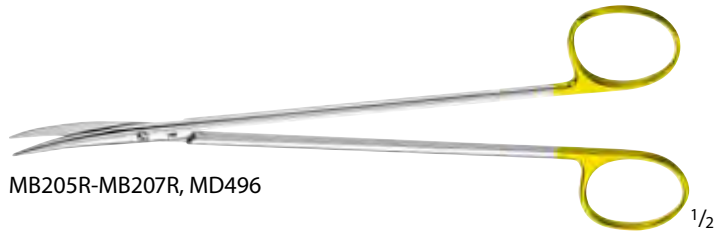

MB205R-MB207R, MD496



MB205R

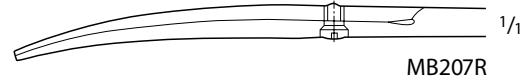

MB207R



MD496

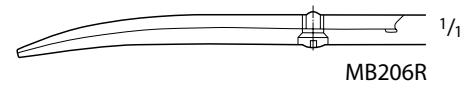

MB206R

DUROTIP TC METZENBAUM Dissecting Scissors, Delicate

Catalog Number	Tip	Blade	Length (in.)
MB205R	S/S	STR	9 1/4
MB207R	S/S	CVD	5 3/4
MD496	S/S	CVD	7
MB206R	S/S	CVD	9 1/4



BC260R-BC265R

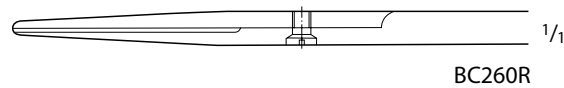

BC260R

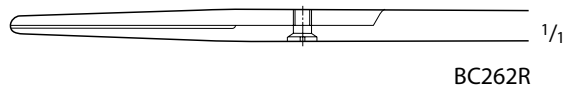

BC262R

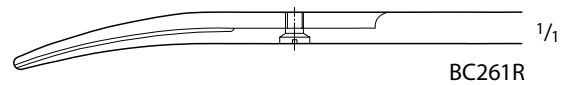

BC261R

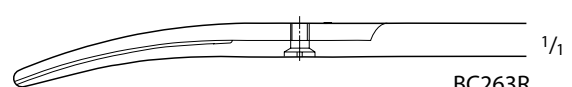

BC263R

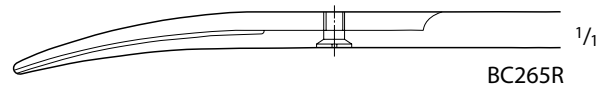

BC265R

DUROTIP TC METZENBAUM Dissecting Scissors

Catalog Number	Tip	Blade	Length (in.)
BC260R	B/B	STR	5 3/4
BC262R	B/B	STR	7
BC261R	B/B	CVD	5 3/4
BC263R	B/B	CVD	7
BC265R	B/B	CVD	7 7/8

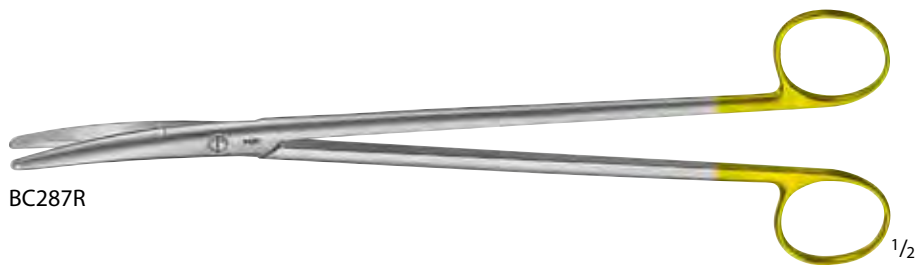

BC287R

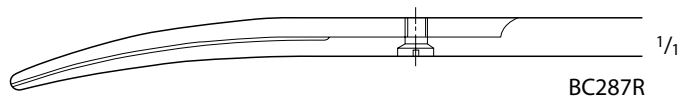

BC287R

DUROTIP TC METZENBAUM Dissecting Scissors

Catalog Number	Tip	Blade	Length (in.)
BC287R	B/B	CVD	9

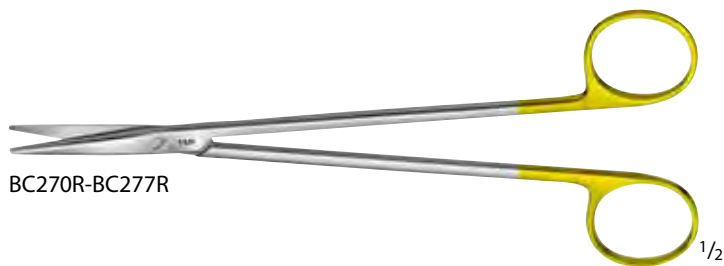

BC270R-BC277R

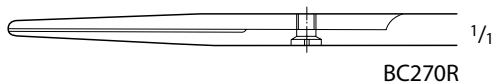

BC270R

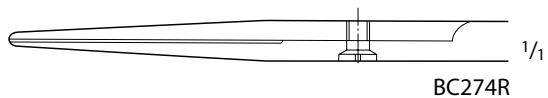

BC274R

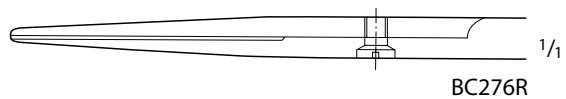

BC276R

DUROTIP TC METZENBAUM Dissecting Scissors, Delicate

Catalog Number	Tip	Blade	Length (in.)
BC270R	B/B	STR	7
BC274R	B/B	STR	7 7/8
BC276R	B/B	STR	9
BC271R	B/B	CVD	7
BC275R	B/B	CVD	7 7/8
BC277R	B/B	CVD	9

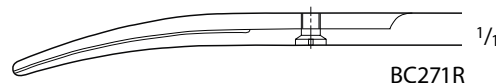

BC271R

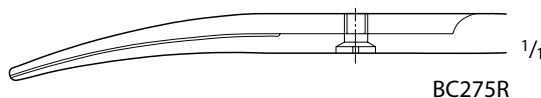

BC275R



BC277R



BC258R-BC259R

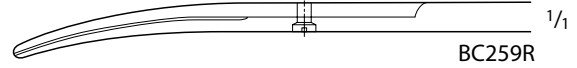
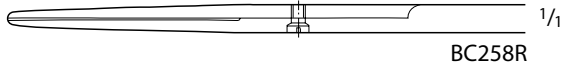

DUROTIP TC Baby METZENBAUM
 Dissecting Scissors, Delicate

Catalog Number	Tip	Blade	Length (in.)
BC258R	B/B	STR	5 3/4
BC259R	B/B	CVD	5 3/4

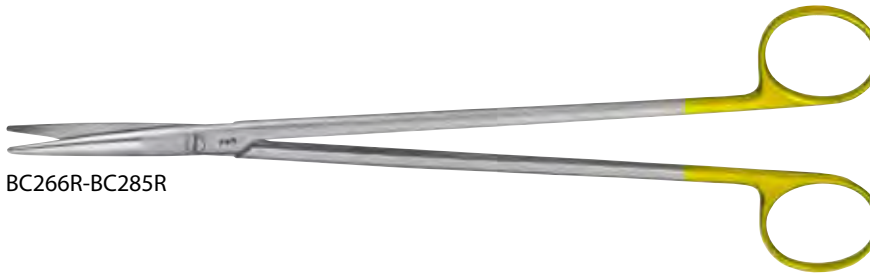

BC266R-BC285R

DUROTIP TC NELSON-METZENBAUM
 Dissecting Scissors

Catalog Number	Tip	Blade	Length (in.)
BC266R	B/B	STR	9
BC267R	B/B	CVD	9
BC279R	B/B	CVD	10 1/4
BC281R	B/B	CVD	11
BC282R	B/B	CVD	11 1/4
BC289R	B/B	CVD	11 3/4
BC285R	B/B	CVD	13 3/4

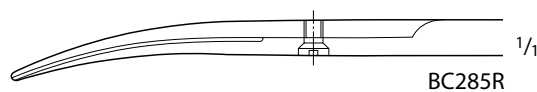
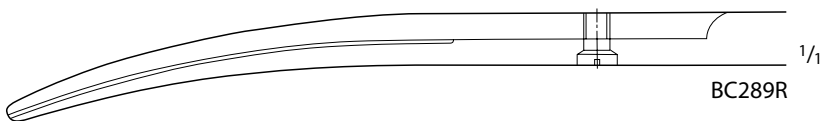
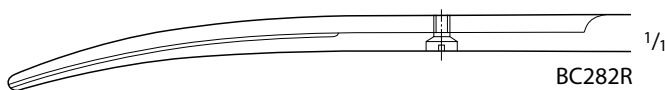
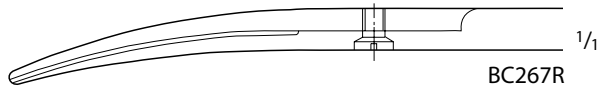
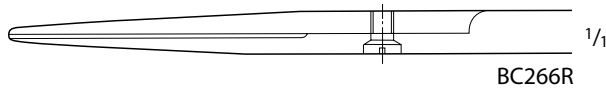

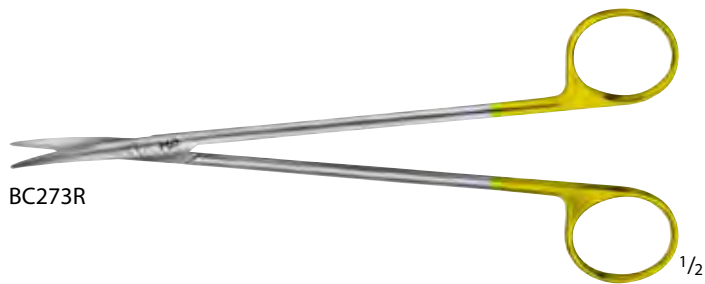

BC273R

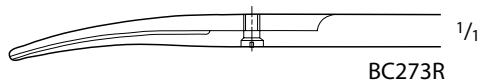

BC273R

DUROTIP TC TOENNIS-ADSON
 Dissecting Scissors, Delicate

Catalog Number	Tip	Blade	Length (in.)
BC273R	B/B	CVD	6 7/8



BC283R

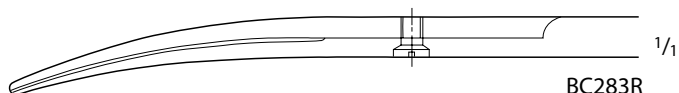

BC283R

DUROTIP TC LEXER Dissecting Scissors,
 Delicate

Catalog Number	Tip	Blade	Length (in.)
BC283R	B/B	CVD	6 1/2



Wavecut

- Wavecut scissors have one serrated cutting edge to prevent tissue from slipping. The W after the item number indicates the scissors are the wavecut style, e.g. BC211W.



BC253W

¹/₂

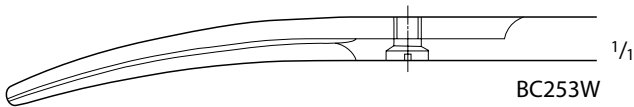

BC253W

¹/₁

DURO TIP TC MAYO Wavecut Dissecting Scissors, Beveled Blades

Catalog Number	Tip	Blade	Length (in.)
BC253W	B/B	CVD	6 3/4



BC259W

¹/₂

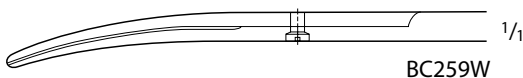

BC259W

¹/₁

DURO TIP TC Baby METZENBAUM Wavecut Dissecting Scissors, Delicate

Catalog Number	Tip	Blade	Length (in.)
BC259W	B/B	CVD	5 3/4

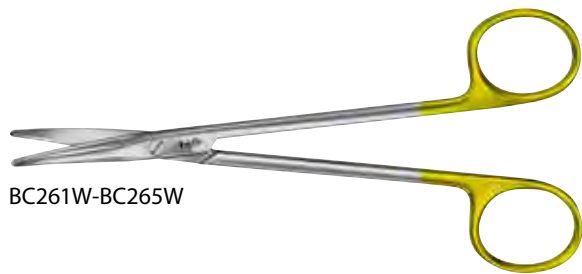

BC261W-BC265W

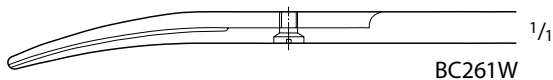

BC261W

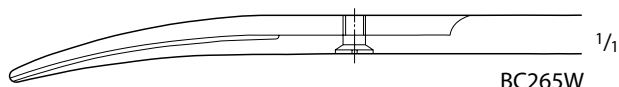

BC265W

DUROTIP TC METZENBAUM Wavecut Dissecting Scissors

Catalog Number	Tip	Blade	Length (in.)
BC261W	B/B	CVD	5 3/4
BC263W	B/B	CVD	7
BC265W	B/B	CVD	7 7/8

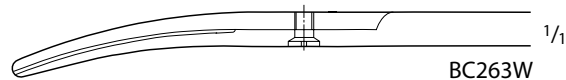

BC263W

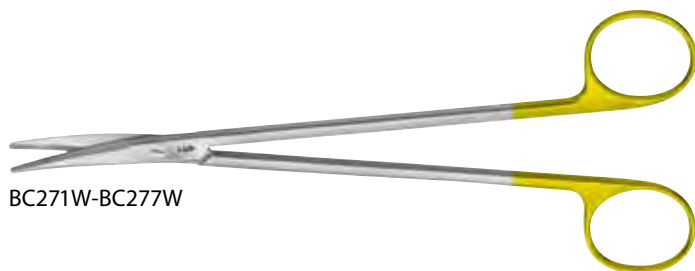

BC271W-BC277W

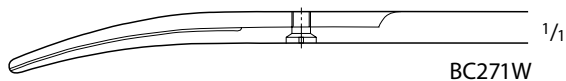

BC271W

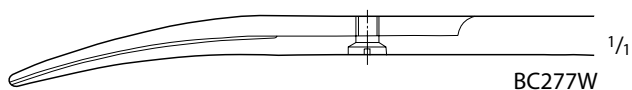

BC277W

DUROTIP TC METZENBAUM Wavecut Dissecting Scissors, Delicate

Catalog Number	Tip	Blade	Length (in.)
BC271W	B/B	CVD	7
BC275W	B/B	CVD	7 7/8
BC277W	B/B	CVD	9

BC275W



BC287W

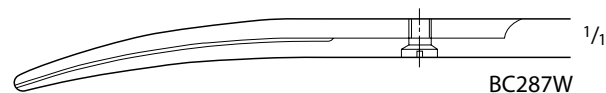

BC287W

DUROTIP TC METZENBAUM Wavecut Dissecting Scissors, Heavy

Catalog Number	Tip	Blade	Length (in.)
BC287W	B/B	CVD	9

DURO TIP TC TOENNIS-ADSON Wavecut Dissecting Scissors

Catalog Number	Tip	Blade	Length (in.)
BC273W	B/B	CVD	6 7/8

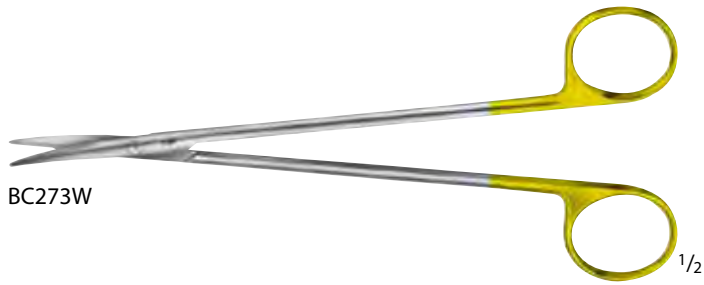

BC273W

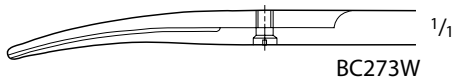

BC273W

DURO TIP TC NELSON-METZENBAUM Wavecut Dissecting Scissors

Catalog Number	Tip	Blade	Length (in.)
BC267W	B/B	CVD	9
BC279W	B/B	CVD	10 1/4
BC281W	B/B	CVD	11

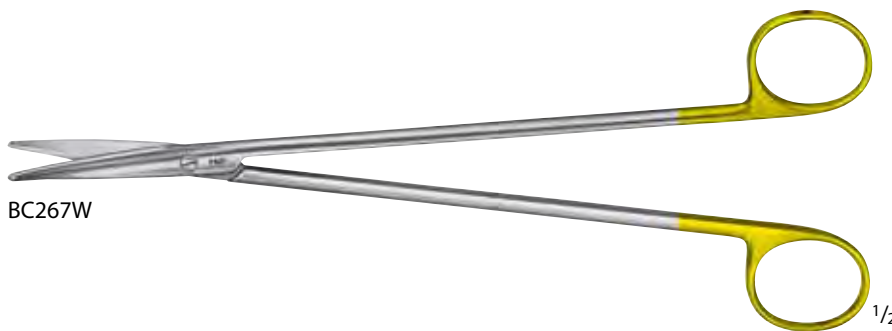

BC267W

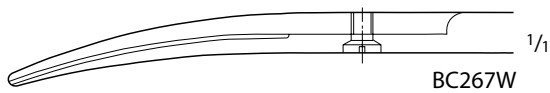

BC267W

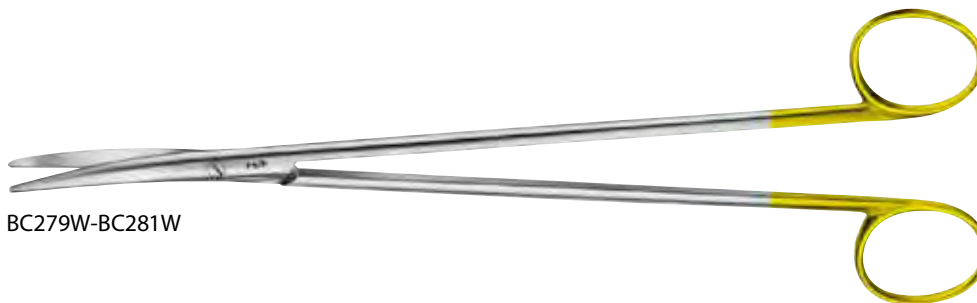

BC279W-BC281W

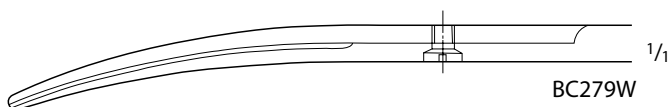

BC279W



BC281W



BC284W

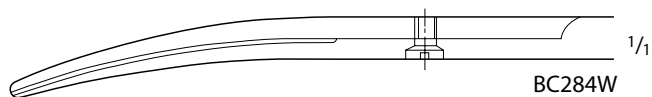

BC284W

DUROTIP TC MAYO-LEXER Wavecut Scissors

Catalog Number	Tip	Blade	Length (in.)
BC284W	B/B	CVD	6 1/2

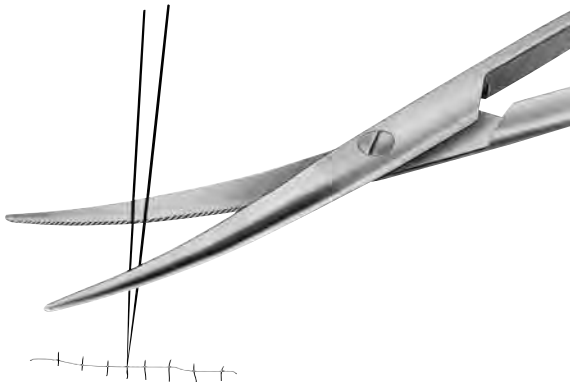

DUROTIP TC Ligature Scissors

- Carbide inserts guarantee permanent sharp cutting edge (also in the distal area of the blades).
- Wavecut prevents suture materials from slipping.
- Identified by 1 gold-plated ring.

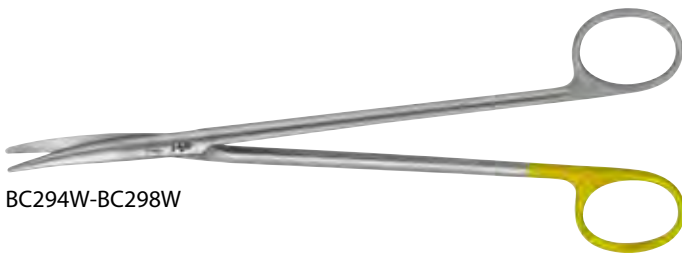

BC294W-BC298W

DUROTIP TC Ligature Wavecut Scissors

Catalog Number	Tip	Blade	Length (in.)
BC294W	B/B	CVD	5 3/4
BC295W	B/B	CVD	7
BC296W	B/B	CVD	9
BC297W	B/B	CVD	10 1/4
BC298W	B/B	CVD	13 3/4

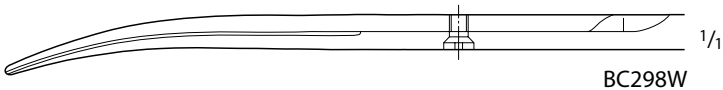
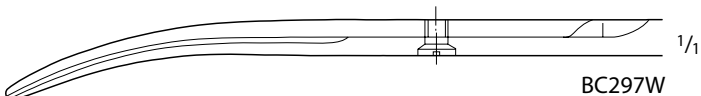
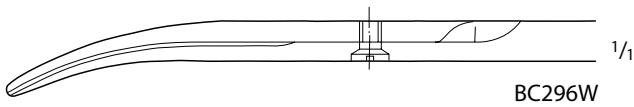
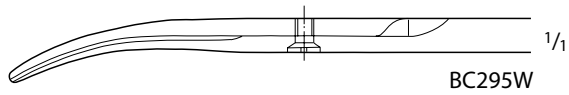
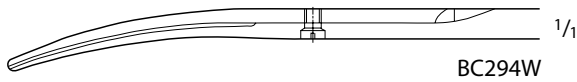

SuperCut Scissors

Your everyday black handle scissors

- Microtome Edge
 - Razor sharp cutting edge facilitates gentle cutting with minimal force
- Wavecut Blade
 - Prevents tissue from slipping out during the cutting process



BC900R-BC901R

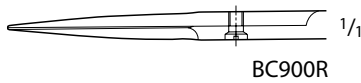

BC900R

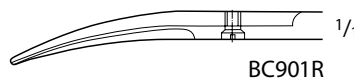

BC901R



BC903R

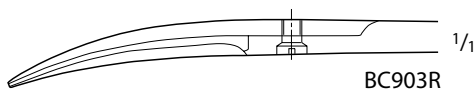

BC903R



BC904R-BC905R

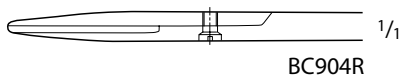

BC904R

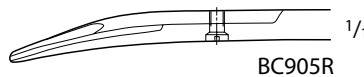

BC905R

Iris SuperCut Scissors, Delicate

Catalog Number	Tip	Blade	Length (in.)
BC900R	S/S	STR	4 1/4
BC901R	S/S	CVD	4 1/4

SuperCut Plastic Standard Scissors

Catalog Number	Tip	Blade	Length (in.)
BC903R	S/S	CVD	5

STEVENS SuperCut Scissors

Catalog Number	Tip	Tip Size (mm)	Blade	Length (in.)
BC904R	B/B	12	STR	4 1/8
BC905R	B/B	12	CVD	4 1/8

STEVENS SuperCut Scissors (continued)

Catalog Number	Tip	Tip Size (mm)	Blade	Length (in.)
BC906R	B/B	13	STR	4 1/4
BC907R	B/B	13	CVD	4 1/4

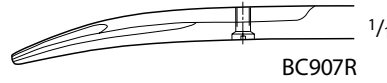
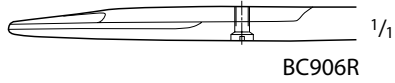

GOLDMANN-FOX SuperCut Scissors

Catalog Number	Tip	Blade	Length (in.)
BC909R	S/S	CVD	5 1/8



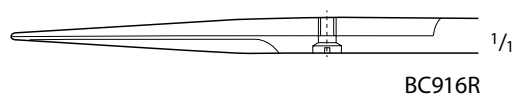
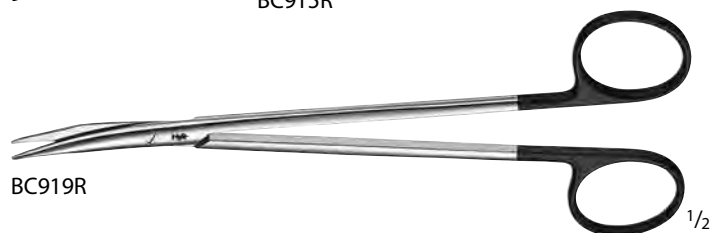

JAMESON SuperCut Scissors, Delicate

Catalog Number	Tip	Blade	Length (in.)
BC911R	B/B	CVD	5 1/8
BC915R	B/B	CVD	6
BC919R	B/B	CVD	7

JOSEPH SuperCut Scissors, Delicate

Catalog Number	Tip	Blade	Length (in.)
BC916R	S/S	STR	6
BC917R	S/S	CVD	6

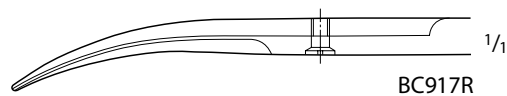

GORNEY SuperCut Scissors, Delicate

Catalog Number	Tip	Blade	Length (in.)
BC920R	B/B	STR	7 3/4
BC921R	B/B	CVD	7 3/4



BC920R-BC921R

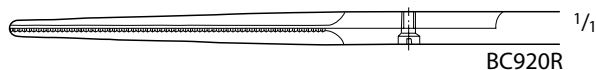

BC920R

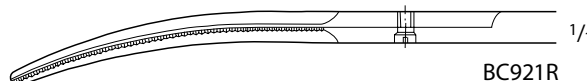

BC921R

KAYE SuperCut Facelift Scissors, Delicate

Catalog Number	Tip	Blade	Length (in.)
BC933R	B/B	CVD	7 3/4



BC933R

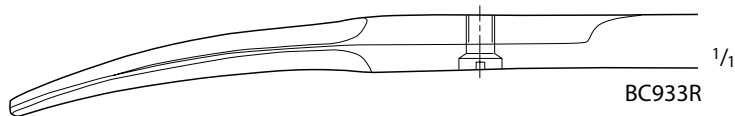

BC933R

MAYO SuperCut Scissors, Delicate

Catalog Number	Tip	Blade	Length (in.)
BC926R	B/B	STR, BEVELED	5 3/4
BC927R	B/B	CVD, BEVELED	5 3/4
BC924R	B/B	STR, ROUND	6 1/2
BC925R	B/B	CVD, ROUND	6 1/2



BC926R-BC927R

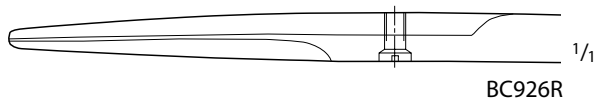

BC926R

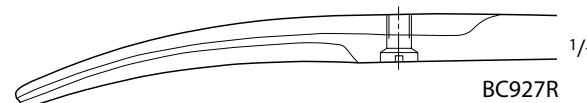

BC927R



BC924R-BC925R

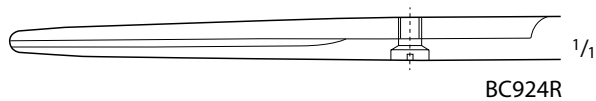

BC924R

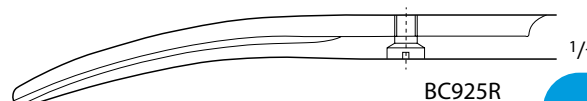

BC925R

MAYO SuperCut Scissors, Beveled

Catalog Number	Tip	Blade	Length (in.)
MG216R	B/B	STR	9
BC922R	B/B	STR	10
BC938R	B/B	STR	12
MG087R	B/B	CVD	9
BC929R	B/B	CVD	11



BC922R-MG216R

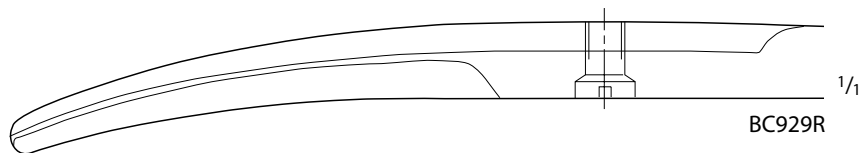
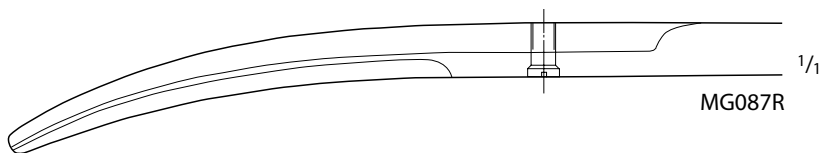
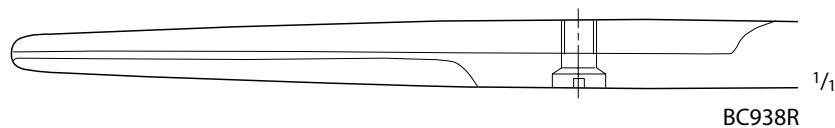
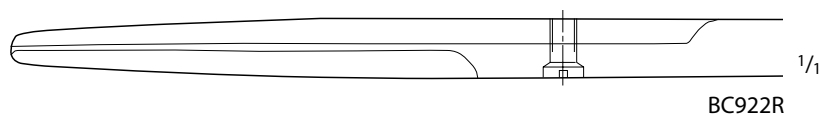
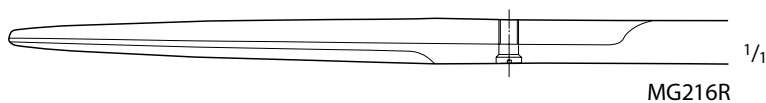

Baby METZENBAUM SuperCut
 Scissors, Delicate

Catalog Number	Tip	Blade	Length (in.)
BC930R	B/B	STR	4 1/2
BC931R	B/B	CVD	4 1/2



BC930R-BC931R

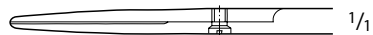

BC930R

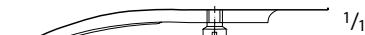

BC931R



BC934R-BC937R

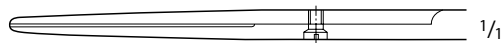

BC934R



BC935R

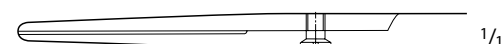

BC936R

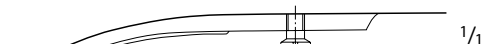

BC937R

METZENBAUM SuperCut Scissors,
 Delicate

Catalog Number	Tip	Blade	Length (in.)
BC934R	B/B	STR	5 3/4
BC936R	B/B	STR	7
BC935R	B/B	CVD	5 3/4
BC937R	B/B	CVD	7

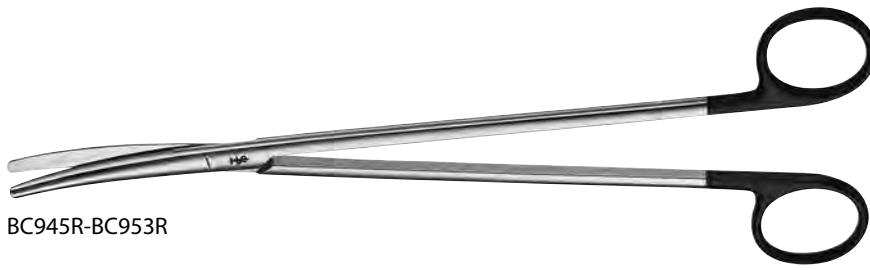

BC945R-BC953R

METZENBAUM SuperCut Scissors, Delicate

Catalog Number	Tip	Blade	Length (in.)
BC945R	B/B	CVD	9
BC947R	B/B	CVD	10 1/4
BC949R	B/B	CVD	11 1/4
BC951R	B/B	CVD	11 3/4
BC953R	B/B	CVD	14



BC945R

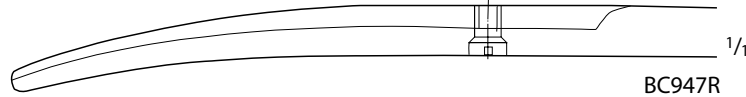

BC947R

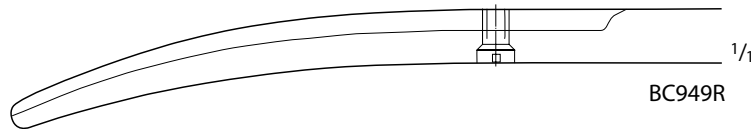

BC949R

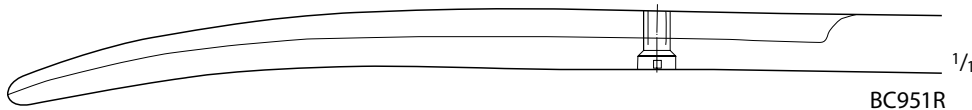

BC951R



BC953R

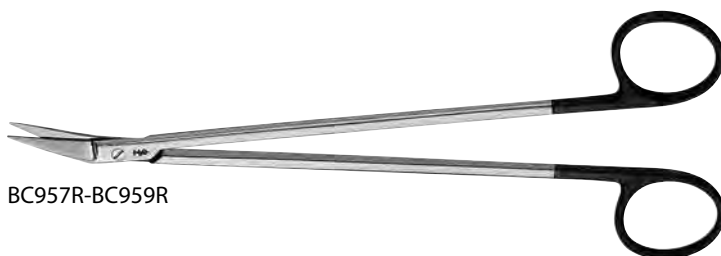

BC957R-BC959R

POTTS-SMITH SuperCut Scissors

Catalog Number	Tip	Blade Angle	Blade Size (mm)	Length (in.)
BC957R	B/B	25°	22	7 1/2
BC958R	B/B	45°	20	7 1/4
BC959R	B/B	60°	19	7



BC957R



BC958R



BC959R

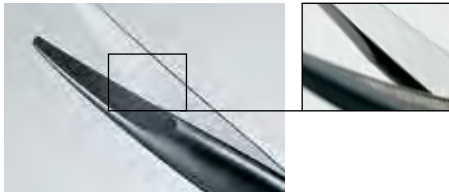

Microtome Edge

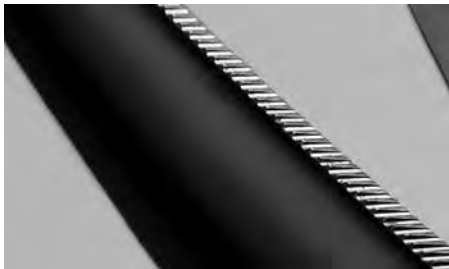

Wavecut

Noir Supreme Cut Scissors

■ Noir

Noir coating results in an extremely high surface hardness and therefore high wear resistance in daily hospital use.

■ Microtome edge

The extremely sharp cutting edge of the scissors blade facilitates gentle cutting of tissue with minimal use of force.

■ Wavecut prevents tissue from slipping out during the cutting process.

■ The WB after the item number indicates the Noir scissors are the wavecut style, e.g. BC211WB.



BC252B-BC253WB



BC252B



BC253B, BC253WB

Noir MAYO Dissecting Scissors

Catalog Number	Tip	Blade	Length (in.)
BC252B	B/B	STR	6 3/4
BC253B	B/B	CVD	6 3/4
BC253WB	B/B	CVD	6 3/4



BC284B-BC284WB



BC284B-BC284WB

Noir MAYO-LEXER Dissecting Scissors

Catalog Number	Tip	Blade	Length (in.)
BC284B	B/B	CVD	6 1/2
BC284WB	B/B	CVD	6 1/2



BC283B-BC283WB

1/2



1/1

BC283B-BC283WB

Noir LEXER Dissecting Scissors

Catalog Number	Tip	Blade	Length (in.)
BC283B	B/B	DEL, CVD	6 1/2
BC283WB	B/B	DEL, CVD	6 1/2



BC210B-BC211WB

1/2



1/1

BC210B



1/1

BC211B, BC211WB

Noir Iris Dissecting Scissors

Catalog Number	Tip	Blade	Length (in.)
BC210B	S/S	STR	4 1/4
BC211B	S/S	CVD	4 1/4
BC211WB	S/S	CVD	4 1/4



BC273B-BC273WB

1/2



1/1

BC273B-BC273WB

Noir TOENNIS-ADSON Dissecting Scissors

Catalog Number	Tip	Blade	Length (in.)
BC273B	B/B	DEL, CVD	6 7/8
BC273WB	B/B	DEL, CVD	6 7/8

Noir METZENBAUM Dissecting Scissors

Catalog Number	Tip	Blade	Length (in.)
BC261B	B/B	CVD	5 3/4
BC261WB	B/B	CVD	5 3/4
BC263B	B/B	CVD	7
BC263WB	B/B	CVD	7
BC271B	B/B	DEL, CVD	7
BC271WB	B/B	DEL, CVD	7
BC265B	B/B	CVD	7 7/8
BC265WB	B/B	CVD	7 7/8
BC275B	B/B	DEL, CVD	7 7/8
BC275WB	B/B	DEL, CVD	7 7/8
BC267B	B/B	CVD	9
BC267WB	B/B	CVD	9
BC277B	B/B	DEL, CVD	9
BC277WB	B/B	DEL, CVD	9

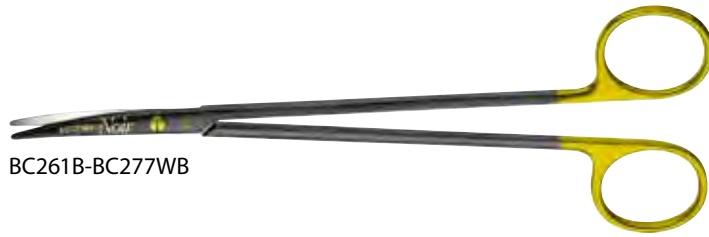

BC261B-BC277WB



BC261B, BC261WB



BC263B, BC263WB



BC271B, BC271WB



BC265B, BC265WB



BC275B, BC275WB



BC267B, BC267WB



BC277B, BC277WB

Noir NELSON-METZENBAUM
 Dissecting Scissors

Catalog Number	Tip	Blade	Length (in.)
BC279B	B/B	DEL, CVD	10 1/4
BC279WB	B/B	DEL, CVD	10 1/4
BC281B	B/B	DEL, CVD	11
BC281WB	B/B	DEL, CVD	11



BC279B-BC281WB



BC279B, BC279WB



BC281B, BC281WB

CONVERSE Needle Holder

Catalog Number	Jaw	Length (in.)
BM200R	LONG SERR	5 1/8



BM200R

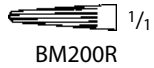

BM200R

HALSEY Needle Holder

Catalog Number	Tip	Jaw	Length (in.)
BM201R	DEL	SMOOTH	5 1/8
BM205R	DEL	X-SERR	5 1/8

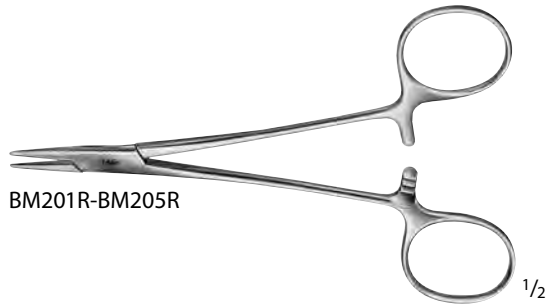

BM201R-BM205R



BM201R



BM205R

WEBSTER Needle Holder

Catalog Number	Jaw	Length (in.)
BM202R	SMOOTH	5



BM202R

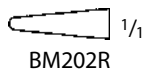

BM202R

DERF Needle Holder

Catalog Number	Jaw	Length (in.)
BM204R	SERR	5



BM204R



BM204R



BM210R



BM210R

DOYEN Needle Holder

Catalog Number	Jaw	Length (in.)
BM210R	X-SERR	5

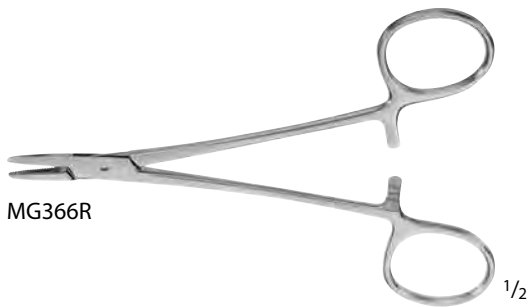

MG366R



MG366R

COLLIER Needle Holder, Fenestrated

Catalog Number	Jaw	Length (in.)
MG366R	SERR	5



BM215R, MG072R



MG072R



BM215R

BAUMGARTNER Needle Holder

Catalog Number	Jaw	Length (in.)
MG072R	SERR, GROOVED	5 1/4
BM215R	X-SERR	5 3/4

CRILE-WOOD Needle Holder

Catalog Number	Jaw	Length (in.)
BM218R	X-SERR	6
BM220R	X-SERR	6 1/4



BM218R-BM220R



BM218R



BM220R

CRILE-MURRAY Needle Holder

Catalog Number	Jaw	Length (in.)
BM219R	SERR	6



BM219R



BM219R

ADSON Needle Holder, Fenestrated

Catalog Number	Jaw	Length (in.)
BM224R	SERR	7

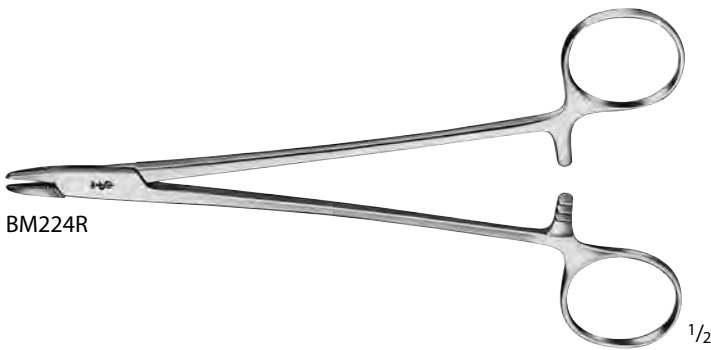

BM224R



BM224R



1/16

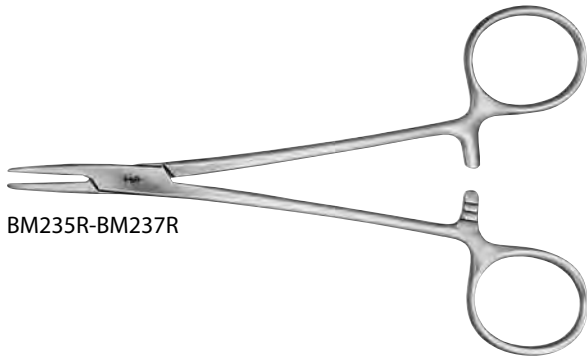

BM235R-BM237R



MAYO-HEGAR Needle Holder

Catalog Number	Jaw	Length (in.)
BM235R	X-SERR	6
BM236R	X-SERR	7 1/4
BM237R	X-SERR	7 7/8



BM245R-BM255R

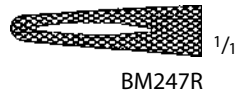

HEGAR Needle Holder

Catalog Number	Tip	Jaw	Length (in.)
BM245R	HEAVY	X-SERR	6
BM247R	HEAVY	X-SERR	6 7/8
BM249R	HEAVY	X-SERR	8
BM255R	HEAVY	X-SERR	8

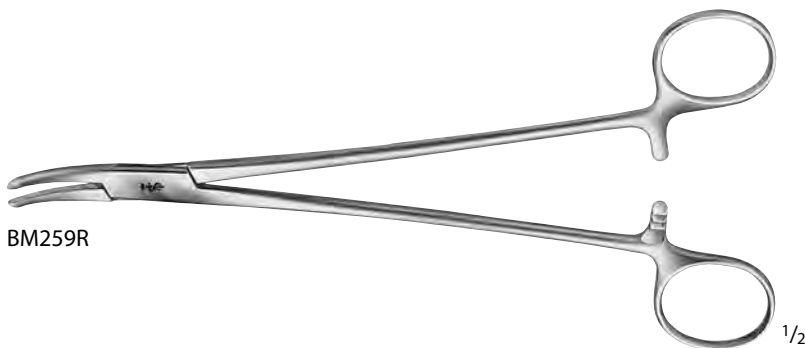

BM259R

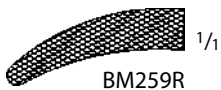

HEANEY Needle Holder

Catalog Number	Tip	Jaw	Length (in.)
BM259R	CVD	SERR	7 7/8

JAMESON Needle Holder

Catalog Number	Tip	Jaw	Length (in.)
BM270R	DEL	X-SERR	9

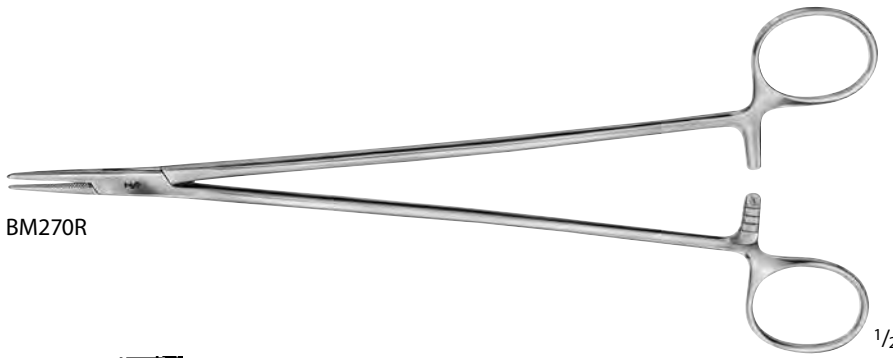

BM270R



BM270R

WANGENSTEEN Needle Holder

Catalog Number	Jaw	Length (in.)
BM272R	X-SERR	10 3/4

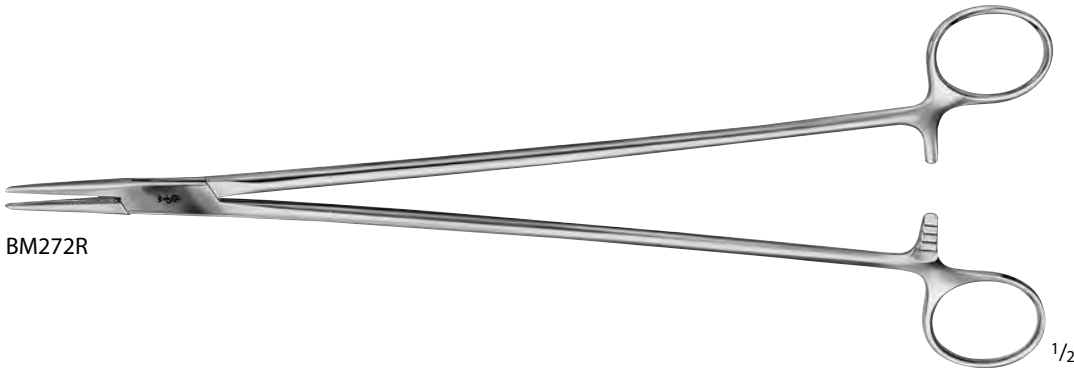

BM272R



BM272R

MASSON Needle Holder

Catalog Number	Jaw	Length (in.)
BM275R	X-SERR	10 1/2

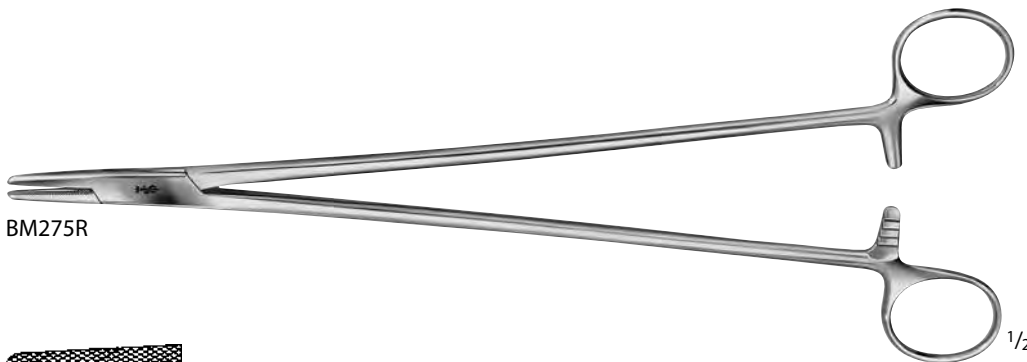

BM275R



BM275R

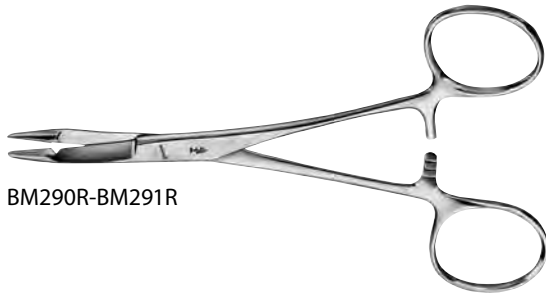

BM290R-BM291R

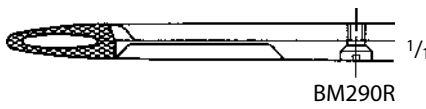
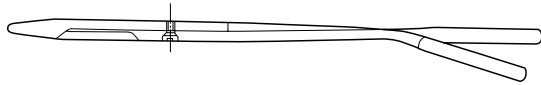

BM290R



HEGAR-OLSEN Needle Holder/Scissors

Catalog Number	Jaw	Length (in.)
BM290R	SERR	5 1/2
BM291R	SERR	7 1/4



BM299R

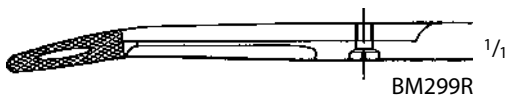
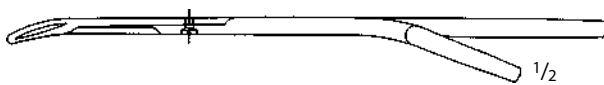

BM299R

GILLIES Needle Holder/Scissors

Catalog Number	Jaw	Length (in.)
BM299R	SERR	6 1/4

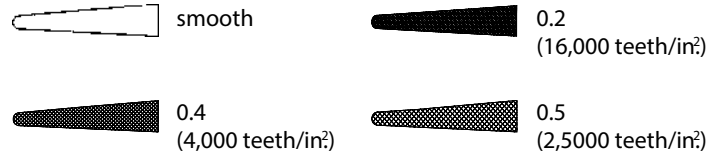

We recommend carbide inserts as follows:

<u>Jaw Surface</u>	<u>Suture Material</u>
Smooth	9/0 - 11/0
0.2 mm pitch of serration	6/0 - 10/0
0.4 mm pitch of serration	4/0 - 6/0
0.5 mm pitch of serration	up to 3/0

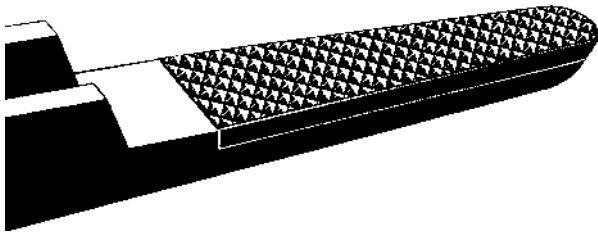

**DUROGRIP TC HELLBERG-KUPKA
 Needle Holder W/ Ergonomic Handle**

Catalog Number	Jaw	Length (in.)
BM320R	SERR	8 1/4



BM320R

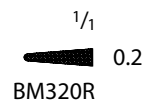

BM320R

DUROGRIP TC DERF Needle Holder

Catalog Number	Jaw	Length (in.)
BM008R	SERR	4 3/4



BM008R

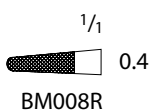

BM008R



BM009R

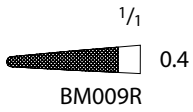
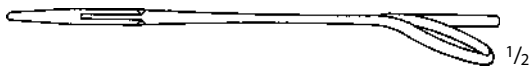

DUROGRIP TC MASING Needle Holder

Catalog Number	Jaw	Length (in.)
BM009R	SERR	5 1/8

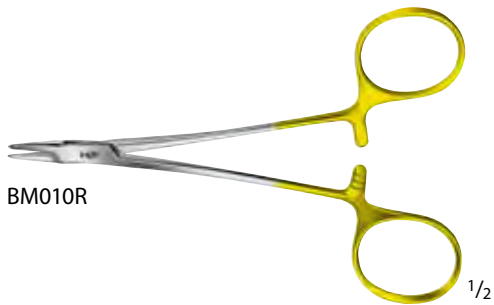

BM010R



BM010R

DUROGRIP TC HALSEY Needle Holder

Catalog Number	Jaw	Length (in.)
BM010R	SMOOTH	4 3/4
BM012R	SERR	5 1/8



BM012R



BM012R



BM011R

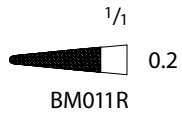

DUROGRIP TC CONVERSE Needle Holder

Catalog Number	Jaw	Length (in.)
BM011R	SERR	5 1/8

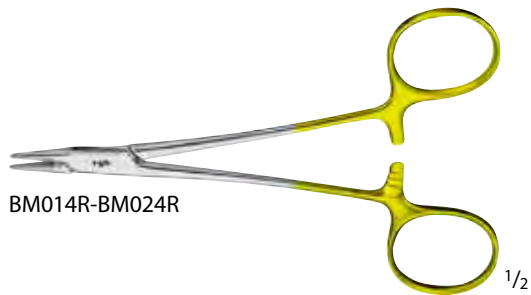

BM014R-BM024R

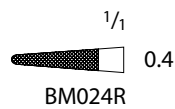
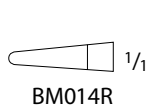

DUROGRIP TC WEBSTER Needle Holder

Catalog Number	Jaw	Length (in.)
BM014R	SMOOTH	5 1/8
BM024R	SERR	5 1/8



BM015R

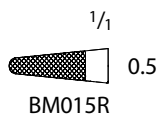

DUROGRIP TC BAUMGARTNER Needle Holder

Catalog Number	Jaw	Length (in.)
BM015R	SERR	5 3/4

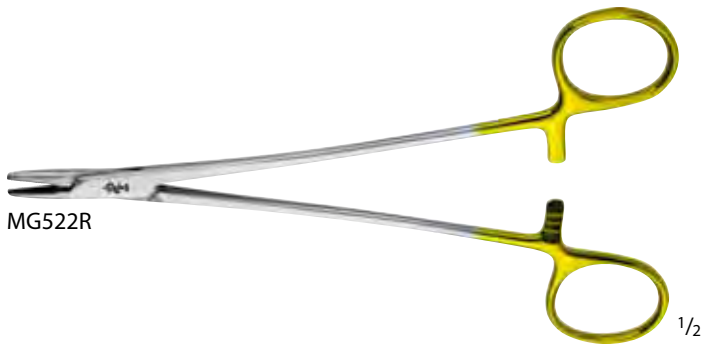

MG522R



MG522R

DUROGRIP TC NEW ORLEANS Needle Holder

Catalog Number	Jaw	Length (in.)
MG522R	SERR	7

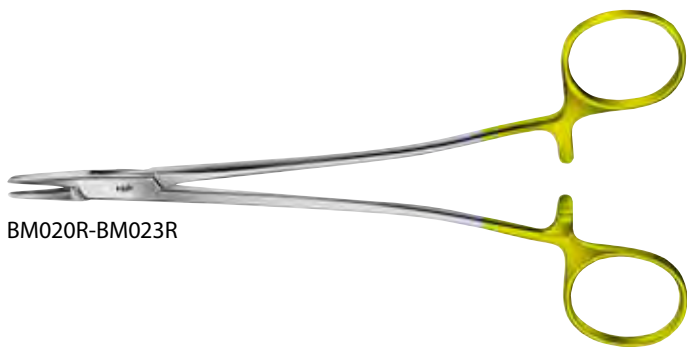

BM020R-BM023R

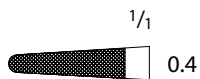

BM020R



BM023R

DUROGRIP TC SAROT Needle Holder

Catalog Number	Jaw	Length (in.)
BM020R	SERR	7
BM023R	SERR	10 1/4

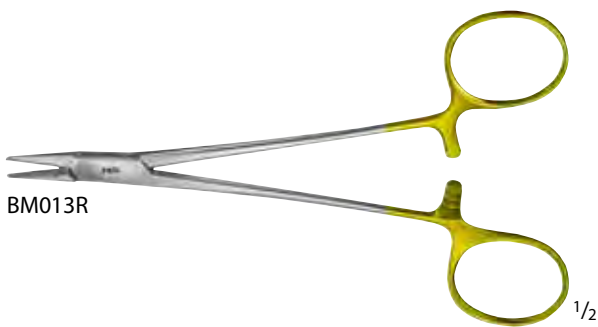

BM013R

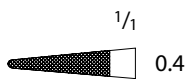

BM013R

DUROGRIP TC Baby CRILE-WOOD Needle Holder

Catalog Number	Jaw	Length (in.)
BM013R	SERR	6

DUROGRIP TC CRILE-WOOD Needle Holder

Catalog Number	Jaw	Length (in.)
BM016R	SERR	5 3/4
BM017R	SERR	7 1/4
BM019R	SERR	7 7/8
BM030R	SERR	10 5/8
BM021R	SERR	12
MB604R	SERR	14
BM029R	SMOOTH	6



BM016R, BM021R, MB604R

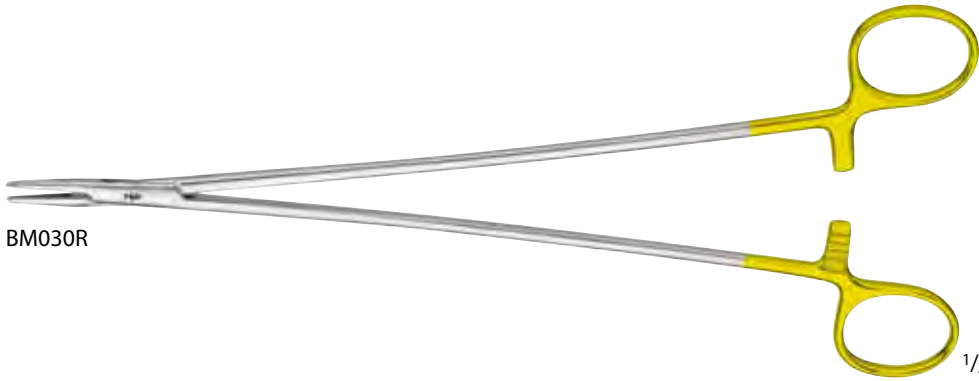
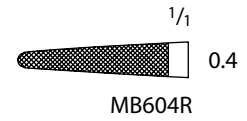
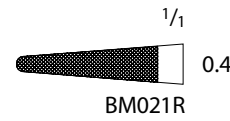
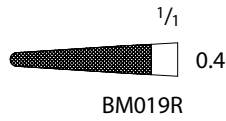
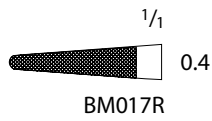
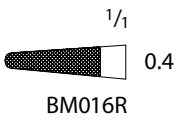

BM030R

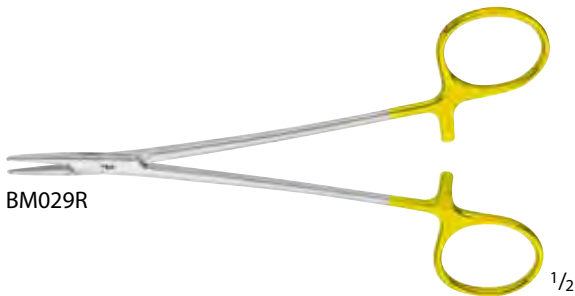
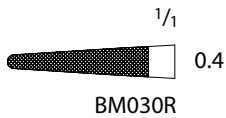

BM029R

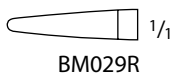

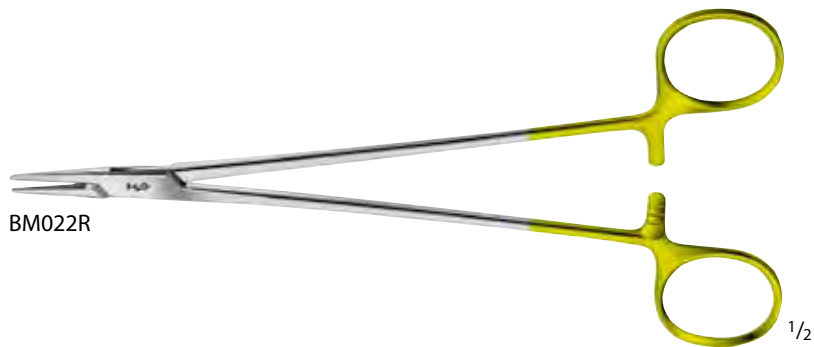

BM022R

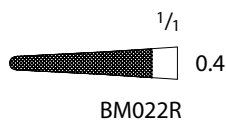

DUROGRIP TC MAYO-HEGAR-SEELEY
 Needle Holder

Catalog Number	Jaw	Length (in.)
BM022R	SERR	8

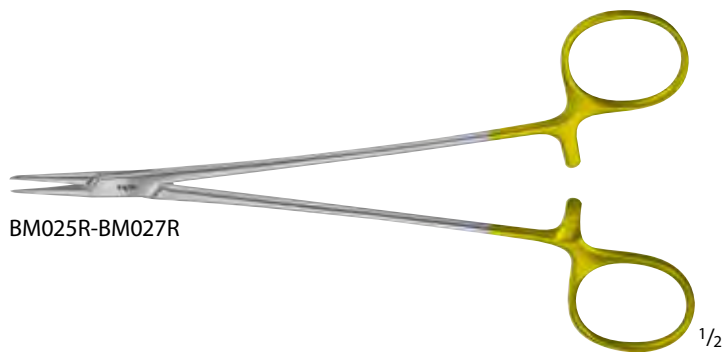

BM025R-BM027R

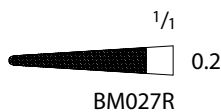
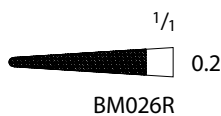
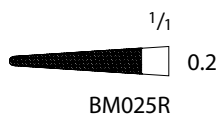

DUROGRIP TC Fine Needle Holder

Catalog Number	Tip	Jaw	Length (in.)
BM025R	X-DEL	SERR	7
BM026R	X-DEL	SERR	7 7/8
BM027R	X-DEL	SERR	9

DUROGRIP TC DEBAKEY Needle Holder

Catalog Number	Tip	Jaw	Length (in.)
BM032R	DEL	SERR	6
BM033R	DEL	SERR	6 1/2
BM035R	DEL	SERR	7
BM034R	DEL	SERR	8 1/4
BM036R	DEL	SERR	9
BM037R	DEL	SERR	10 1/4
BM038R	DEL	SERR	12
BM063R	X-DEL	SERR	6 1/2
BM064R	X-DEL	SERR	8 1/4
BM040R	X-DEL	SERR	12



BM032R

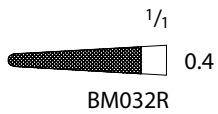

BM033R-BM034R, BM063R-BM064R

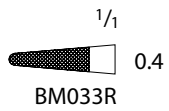

BM033R

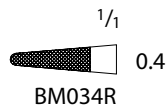

BM034R

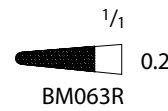

BM063R

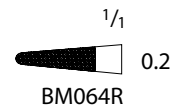

BM064R

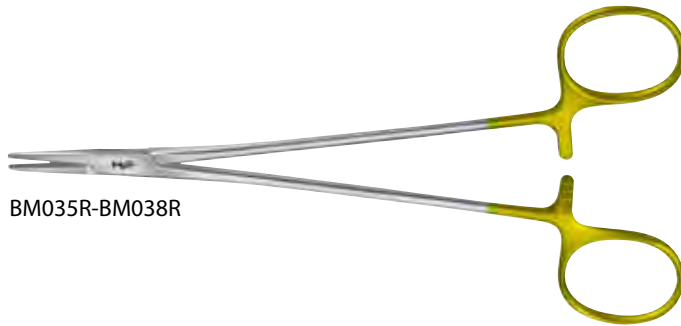

BM035R-BM038R

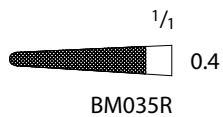

BM035R

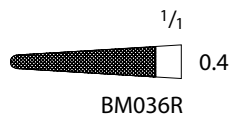

BM036R

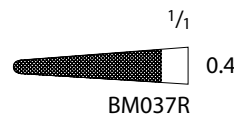

BM037R

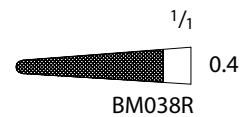

BM038R

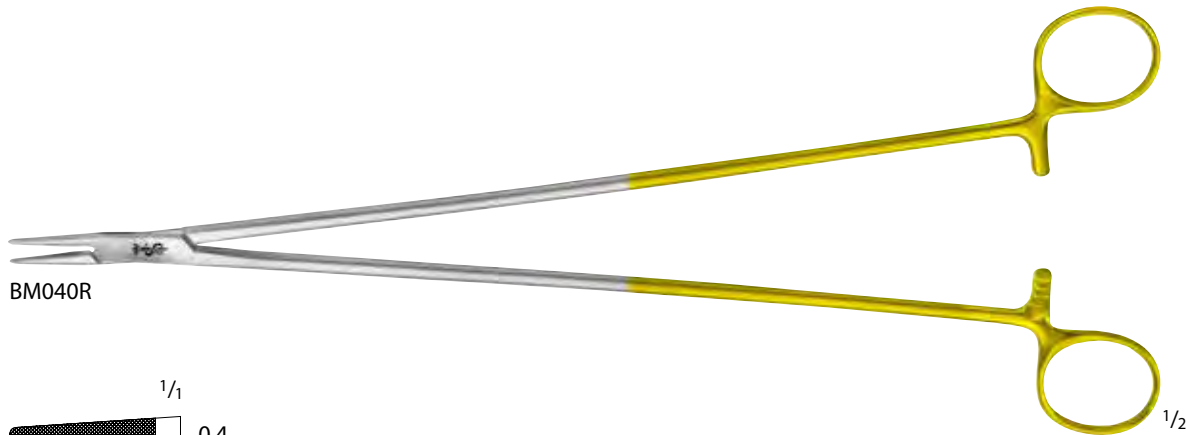

BM040R

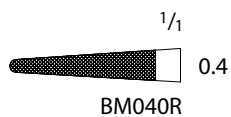

BM040R

Let Us know if you could not find what you are looking for

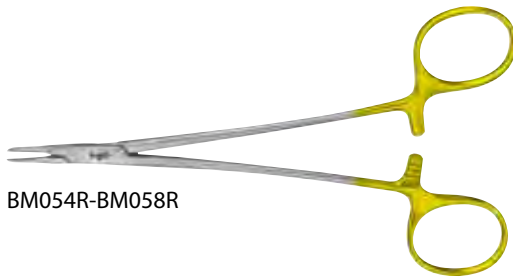

BM054R-BM058R

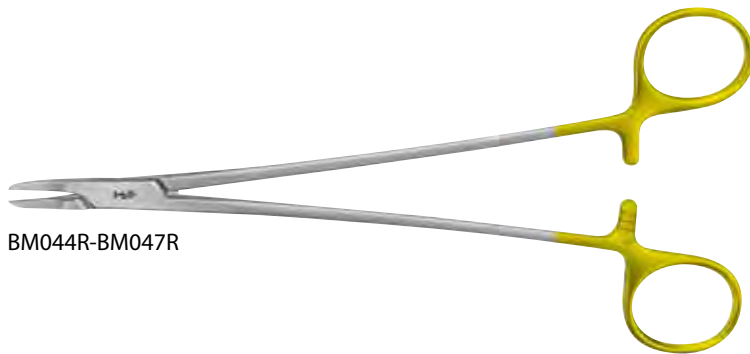
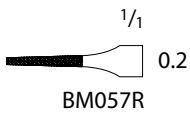
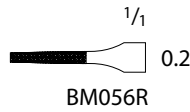
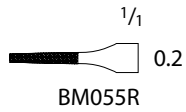
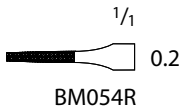

BM044R-BM047R

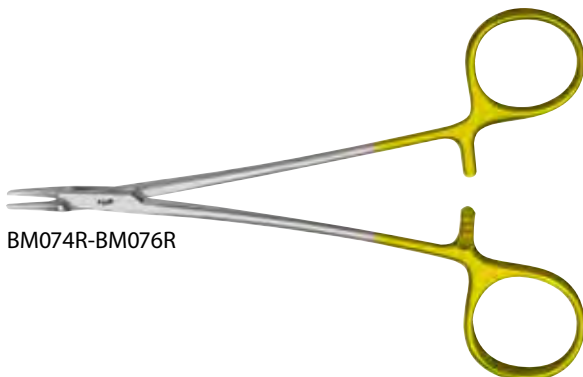
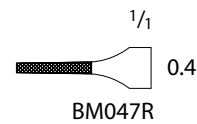
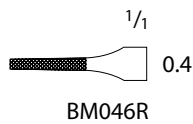
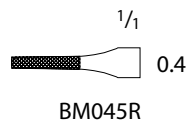
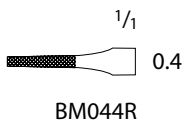

BM074R-BM076R

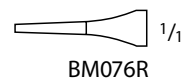
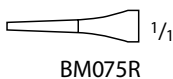

DUROGRIP TC RYDER Needle Holder

Catalog Number	Tip	Jaw	Length (in.)
BM054R	X-DEL	SERR	5 1/4
BM055R	X-DEL	SERR	6 1/8
BM056R	X-DEL	SERR	6 7/8
BM057R	X-DEL	SERR	8 1/4
BM058R	X-DEL	SERR	9
BM044R	DEL	SERR	5 1/4
BM045R	DEL	SERR	6 7/8
BM046R	DEL	SERR	7 3/4
BM047R	DEL	SERR	10 1/2
BM074R	DEL	SMOOTH	6
BM075R	DEL	SMOOTH	7
BM076R	DEL	SMOOTH	8 7/8

Let Us know if you could not find what you are looking for

DUROGRIP TC FRENCH Eye Needle Holder

Catalog Number	Jaw	Length (in.)
MB606R	SERR	6 1/4
MB607R	SERR	7 1/4
MB611R	SERR	8
MB612R	SERR	9 1/4

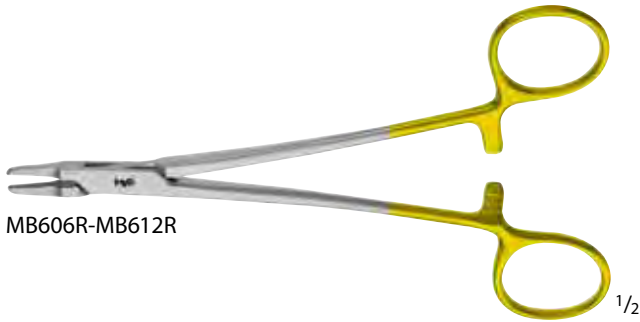

MB606R-MB612R

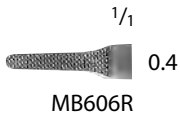

MB606R

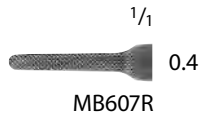

MB607R



MB611R

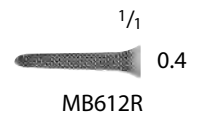

MB612R



BM065R-BM070R

DUROGRIP TC MAYO-HEGAR Needle Holder

Catalog Number	Jaw	Length (in.)
BM065R	SERR	6
BM066R	SERR	7 1/4
BM067R	SERR	8
BM068R	SERR	9 1/4
BM070R	SERR	10 1/2
BM069R	SERR	12
MB617R	SERR	14

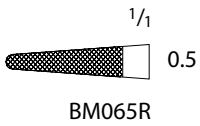

BM065R

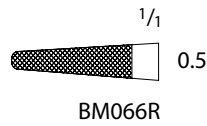

BM066R

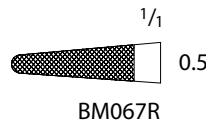

BM067R

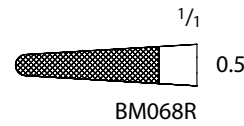

BM068R

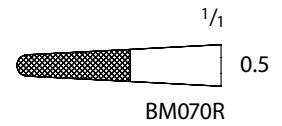

BM070R

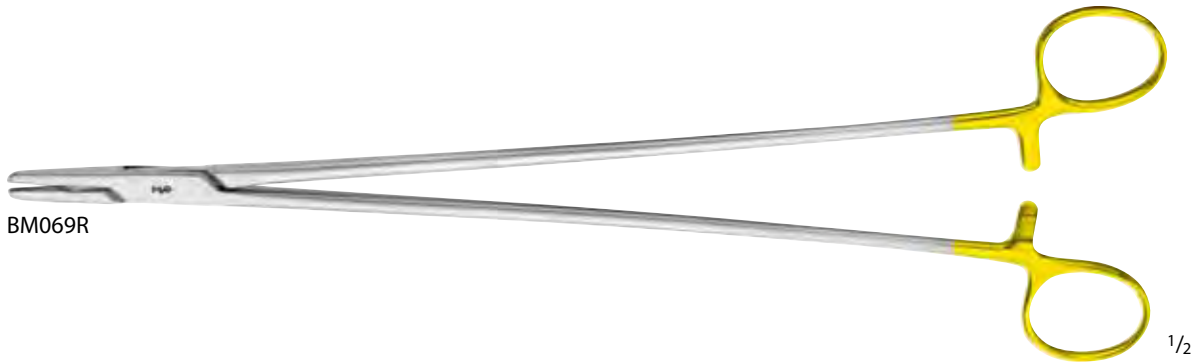

BM069R

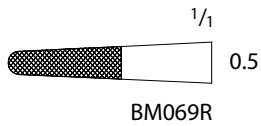

BM069R

1/2

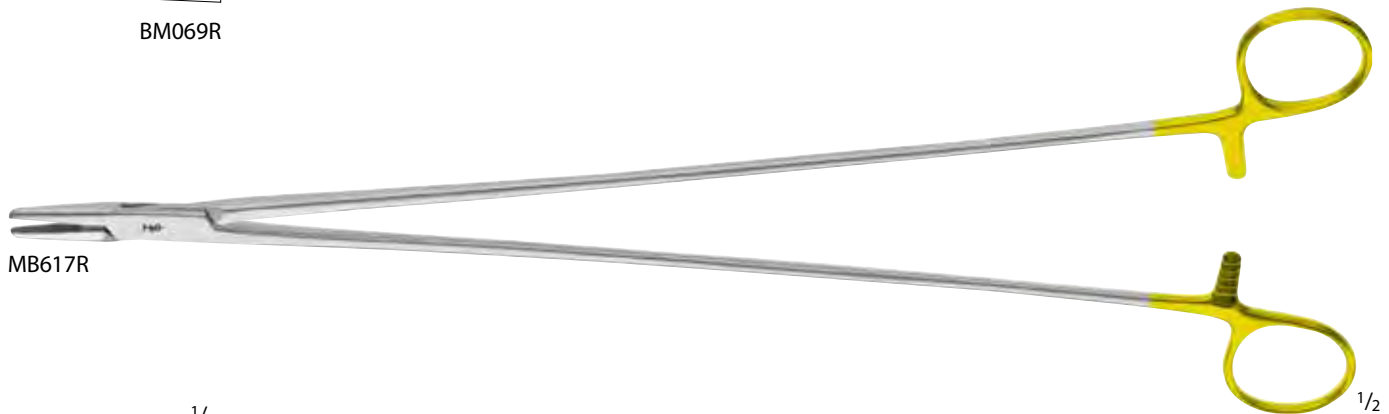

MB617R

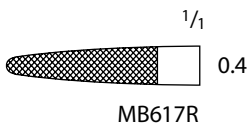

MB617R

1/2

DUROGRIP TC HEGAR Needle Holder

Catalog Number	Tip	Jaw	Length (in.)
BM077R	HEAVY	SERR	8
BM078R	HEAVY	SERR	9 1/2

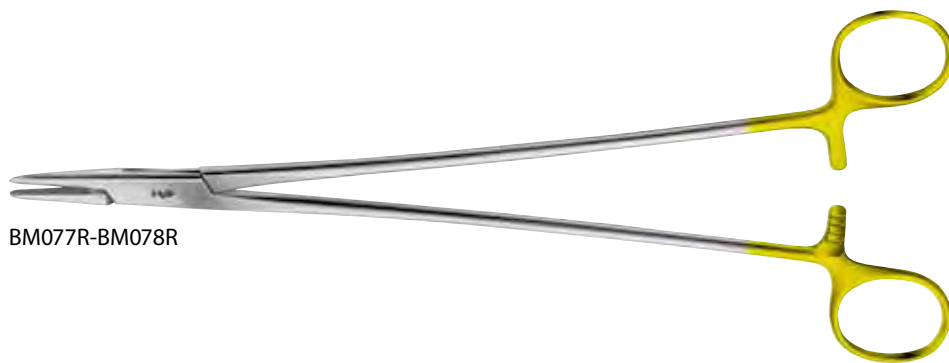

BM077R-BM078R

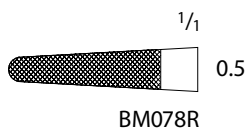
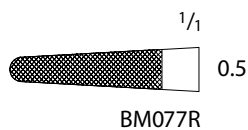

DUROGRIP TC WANGENSTEEN Needle Holder

Catalog Number	Jaw	Length (in.)
BM042R	SERR	10 3/4

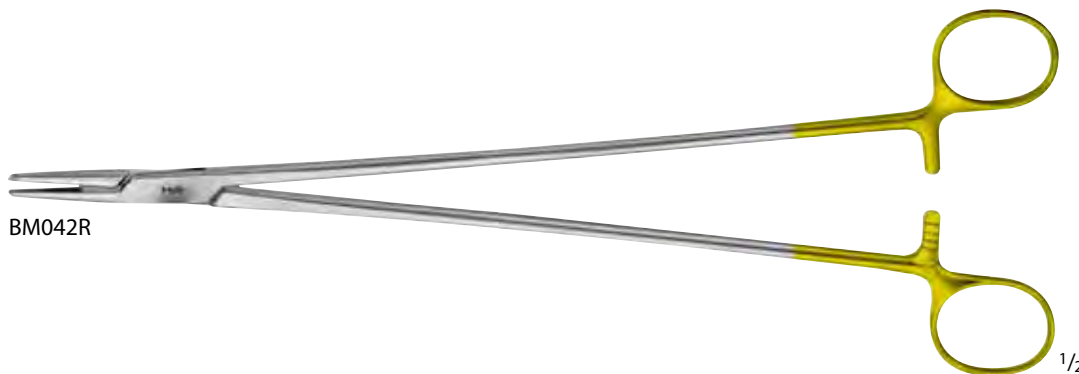

BM042R

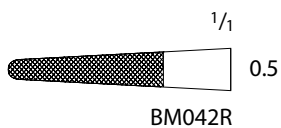

DUROGRIP TC MASSON Needle Holder

Catalog Number	Jaw	Length (in.)
BM090R	SERR	10 1/2

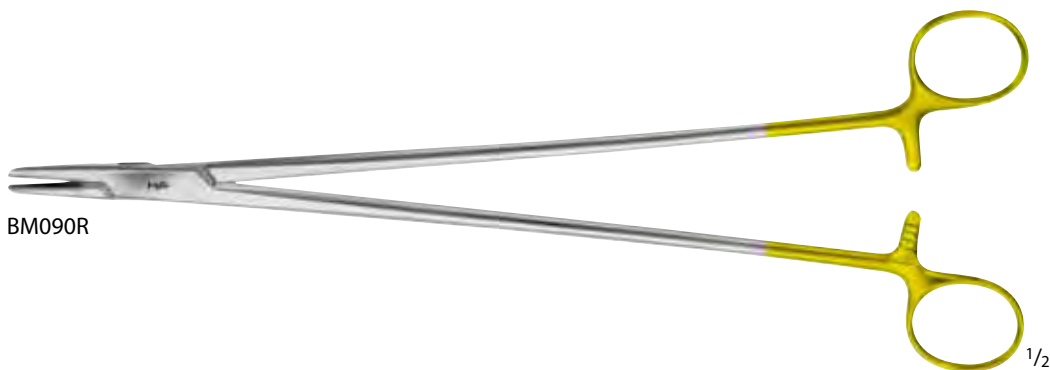

BM090R

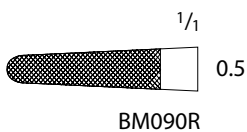

BM090R

DUROGRIP TC MAYO-MASSON Needle Holder

Catalog Number	Jaw	Length (in.)
MB918R	SERR	16

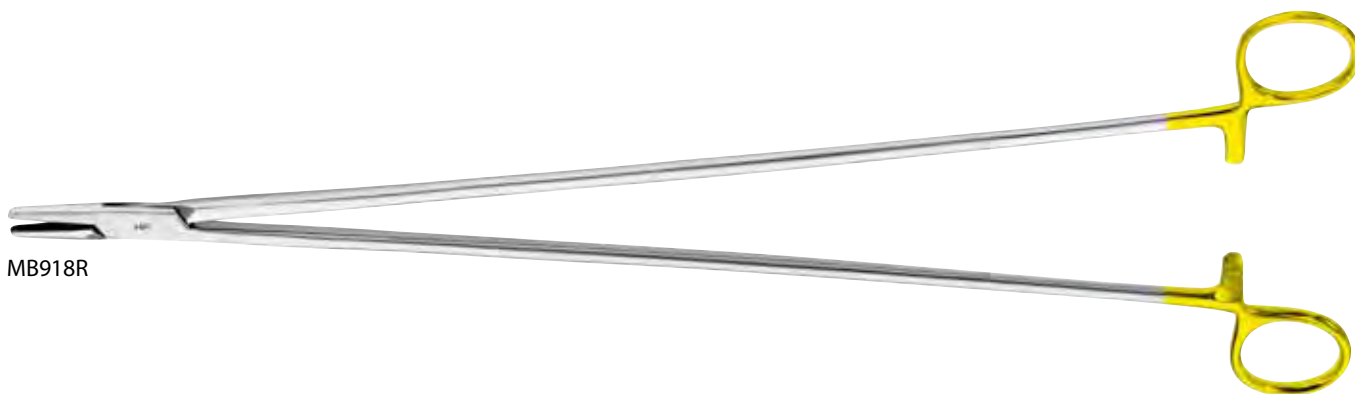

MB918R



MB918R

DUROGRIP TC HEANEY Needle Holder

Catalog Number	Tip	Jaw	Length (in.)
BM081R	CVD	SERR	7 7/8
BM084R	CVD	SERR	10 1/4

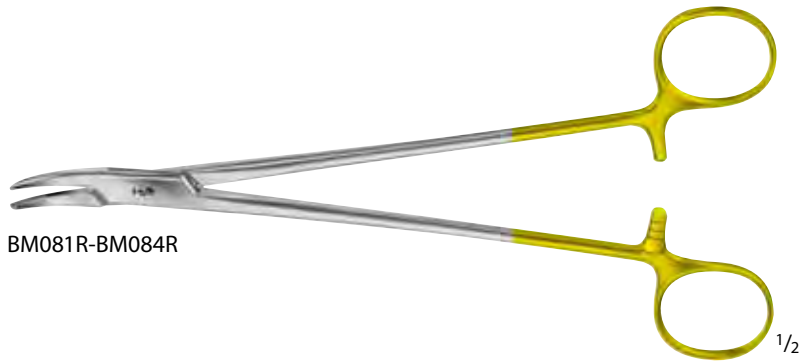

BM081R-BM084R

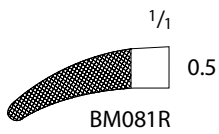

BM081R

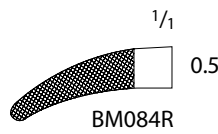

BM084R

DUROGRIP TC MUELLER Needle Holder

Catalog Number	Tip	Jaw	Length (in.)
BM089R	CVD	SERR	14 1/4

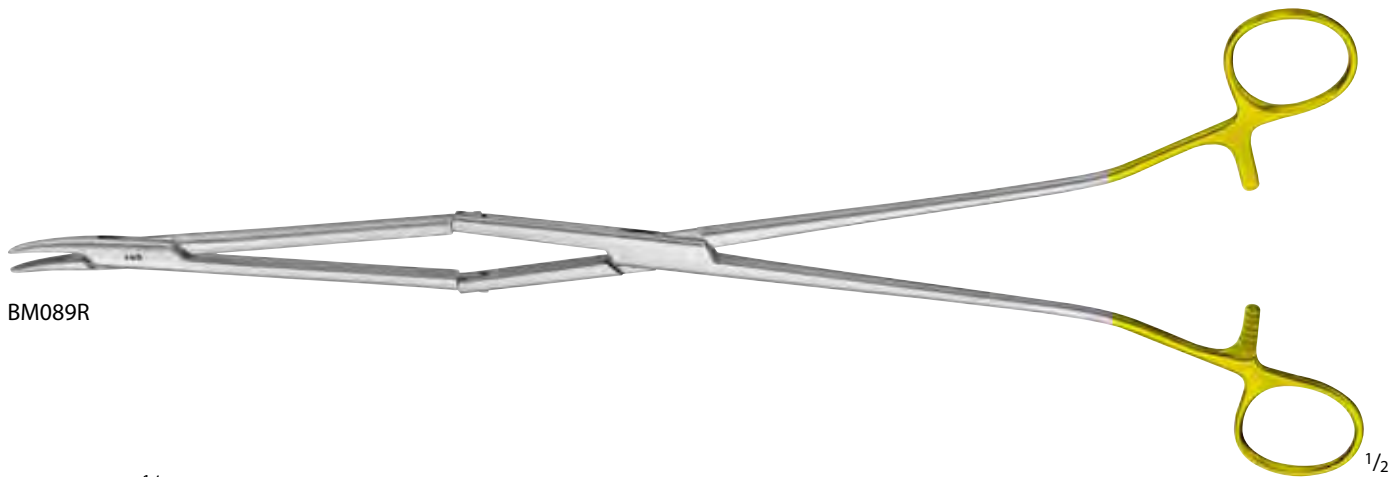

BM089R

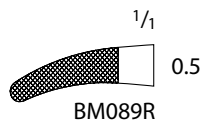

BM089R

DUROGRIP TC FINOCHIETTO Needle Holder

Catalog Number	Tip	Jaw	Length (in.)
BM092R	ANG	SERR	10 1/2

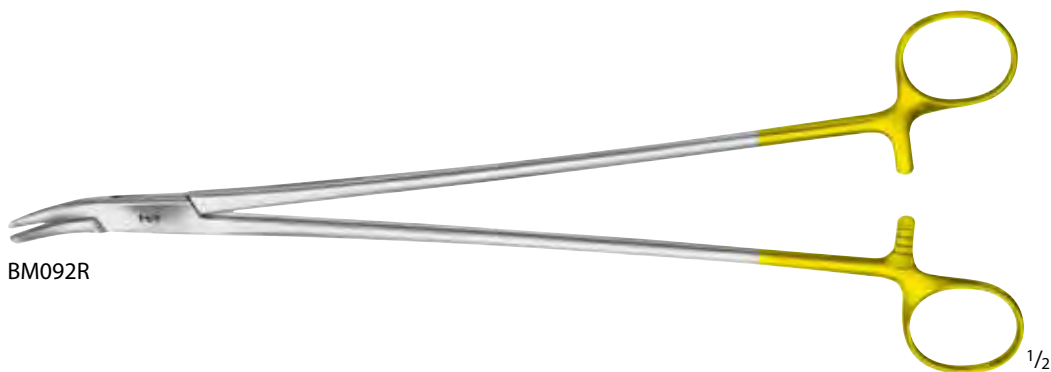

BM092R

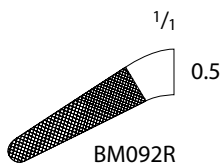

BM092R

DUROGRIP TC STRATTE Needle Holder

Catalog Number	Tip	Jaw	Length (in.)
BM095R	CVD	SERR	8 1/4
BM096R	CVD	SERR	9

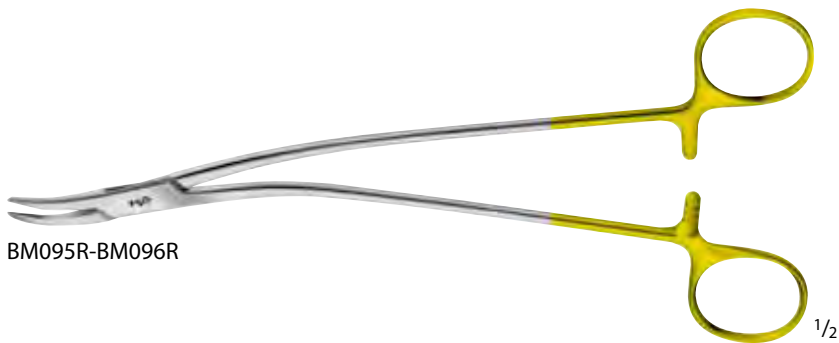

BM095R-BM096R

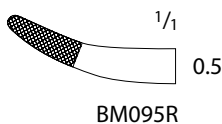

BM095R

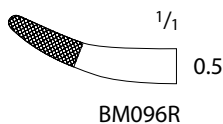

BM096R

DUROGRIP TC Wire Twister

Catalog Number	Tip	Jaw	Length (in.)
BM110R	ROUND	SERR	6 1/8
BM111R	SQUARE	SERR	6

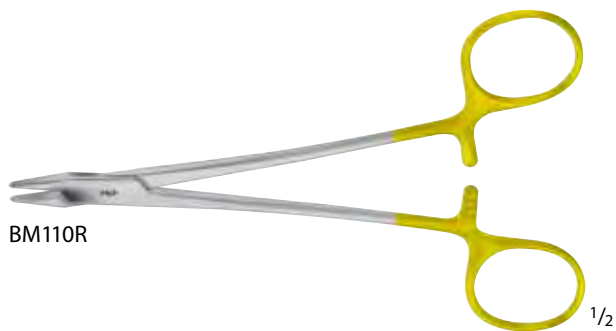

BM110R

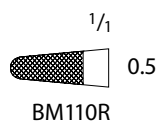

BM110R

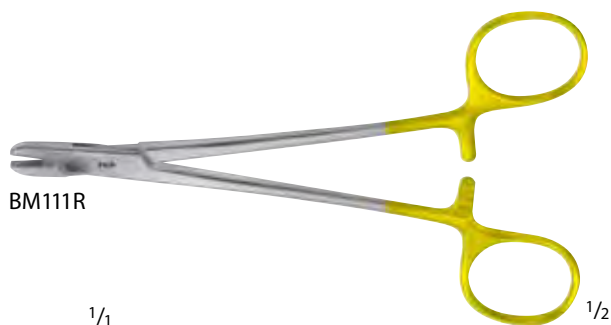

BM111R

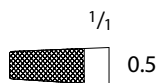

BM111R

DUROGRIP TC BAUMGARTNER Wire Twister

Catalog Number	Tip	Jaw	Length (in.)
BM112R	SQUARE	SERR	7 7/8

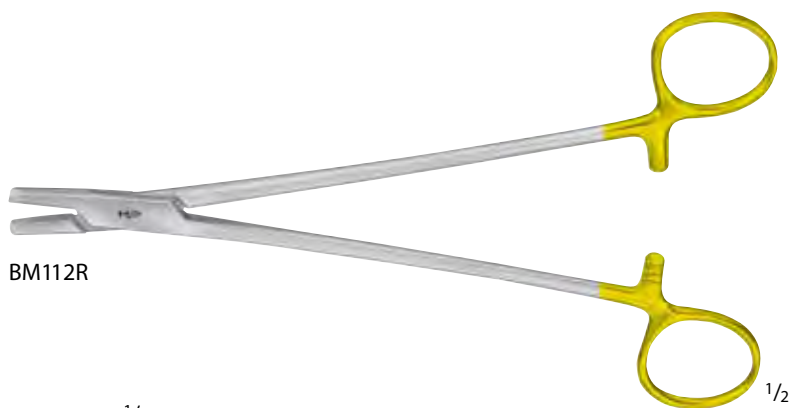

BM112R

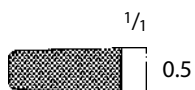

BM112R



1/16

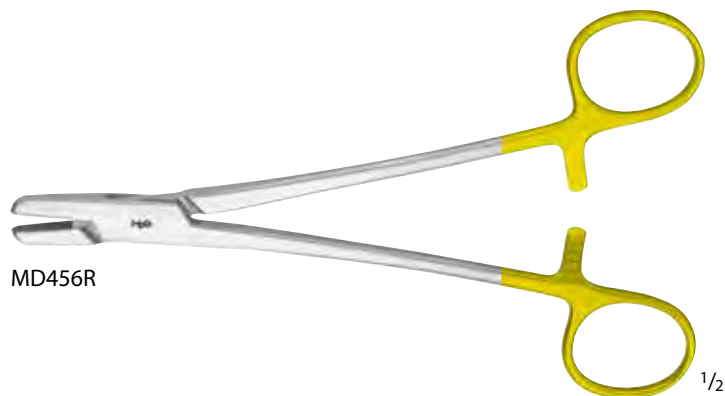

MD456R

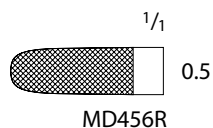

DUROGRIP TC BERRY Sternal Wire
 Twister

Catalog Number	Tip	Jaw	Length (in.)
MD456R	ROUND	SERR	7 1/4



MB550R

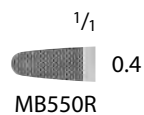

DUROGRIP TC RUBIO Wire Twister

Catalog Number	Tip	Jaw	Length (in.)
MB550R	ROUND	SERR	5



BM149R-BM154R

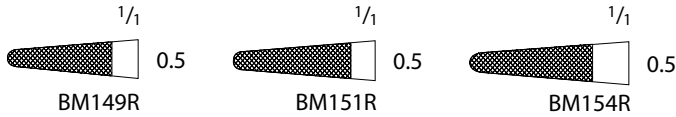

DUROGRIP TC MATHIEU Needle Holder

Catalog Number	Jaw	Length (in.)
BM149R	SERR	5 1/2
BM151R	SERR	6 1/2
BM154R	SERR	7 7/8

General Surgery
 DUROGRIP™ TC Needle Holders



BM156R-BM158R



DUROGRIP TC MATHIEU Needle Holder,
 Heavy

Catalog Number	Jaw	Length (in.)
BM156R	SERR	7 7/8
BM158R	SERR	9 5/8



BL907R

Needle Case, Rectangle

Catalog Number	Dimensions (mm)
BL907R	70 x 53 x 9



BL930R-BL933R

Needle Case, Round

Catalog Number	Item	Dimensions (mm)
BL930R	COMPLETE NEEDLE CASE W/ INTERIOR BOX	65 x 16
BL931R	INTERIOR BOX ONLY	62 x 12
BL933R	INTERIOR BOX ONLY	90 x 12



BL931R-BL933R



BL941R

Needle Case, With 7 Sections

Catalog Number	Dimensions (mm)
BL941R	150 x 90 x 10



BM822R-BM824R

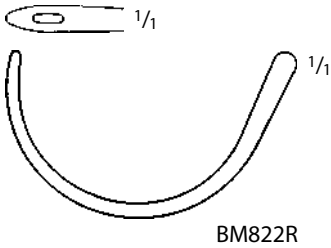

BM822R

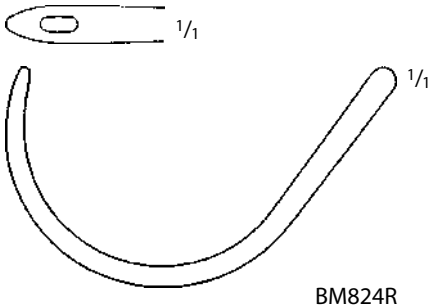

BM824R



BM749R, BM781R, BM807R, BM809R,
 BM811R, BM813R

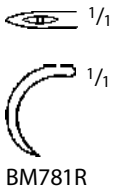

BM781R

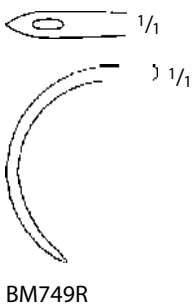

BM749R

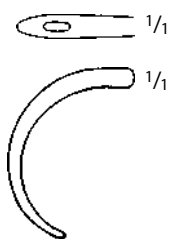

BM809R

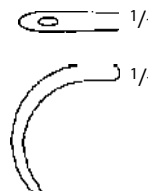

BM807R

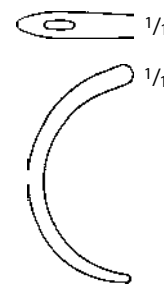

BM811R



BM813R

DESCHAMPS Needle

Catalog Number	Hand Orientation	Tip	Length (in.)
BM822R	RIGHT	BLUNT, 3.5 MM	9 1/2
BM824R	RIGHT	BLUNT, 5 MM	11
BM781R	LEFT	SHARP, 2 MM	8 1/4
BM749R	LEFT	SHARP, 3.5 MM	8 1/2
BM809R	LEFT	BLUNT, 2.5 MM	8 1/4
BM807R	LEFT	BLUNT, 2.5 MM	8 1/2
BM811R	LEFT	BLUNT, 3.5 MM	8 1/2
BM813R	LEFT	STEEP, BLUNT, 2 MM	8 7/8



BM770R

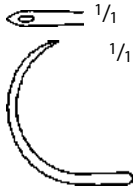

BM770R



BM771R

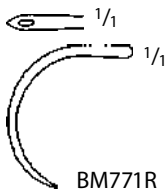

BM771R



BM801R

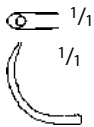

BM801R



BM802R

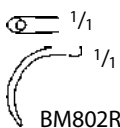

BM802R



BM855R

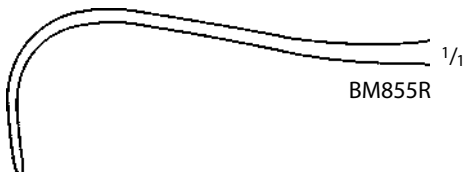

BM855R

HURD Needle

Catalog Number	Hand Orientation	Tip	Length (in.)
BM770R	RIGHT	SHARP	8 1/4
BM771R	LEFT	SHARP	8 1/4

KRONECKER Needle

Catalog Number	Hand Orientation	Tip	Length (in.)
BM801R	RIGHT	BLUNT	6 1/8
BM802R	LEFT	BLUNT	6 1/8

SYME Suture Needle

Catalog Number	Tip	Length (in.)
BM855R	BLUNT	6 3/4



BM770R

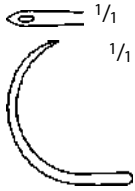

BM770R



BM771R

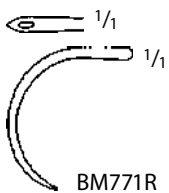

BM771R



BM801R

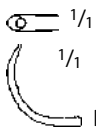

BM801R



BM802R

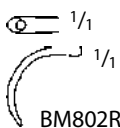

BM802R



BM855R

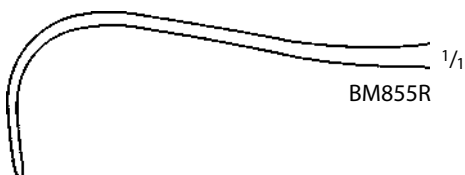

BM855R

HURD Needle

Catalog Number	Hand Orientation	Tip	Length (in.)
BM770R	RIGHT	SHARP	8 1/4
BM771R	LEFT	SHARP	8 1/4

KRONECKER Needle

Catalog Number	Hand Orientation	Tip	Length (in.)
BM801R	RIGHT	BLUNT	6 1/8
BM802R	LEFT	BLUNT	6 1/8

SYME Suture Needle

Catalog Number	Tip	Length (in.)
BM855R	BLUNT	6 3/4

Monopolar Diathermi Forceps,
 Insulated

Catalog Number	Length (in.)
GK033R	13 3/4

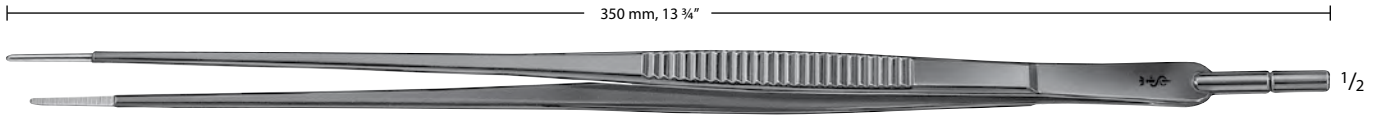

GK033R



BD043R-BD053R

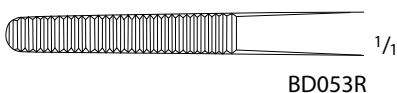
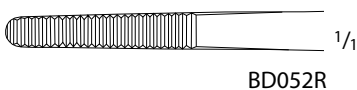
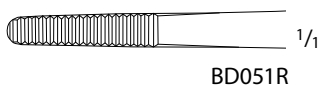
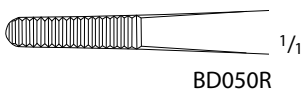
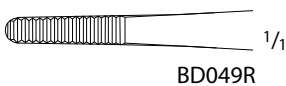
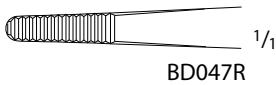
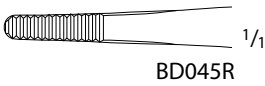
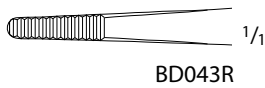

BD077R

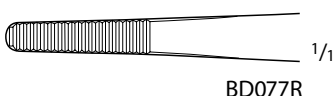

Dressing Forceps, Standard Patterns

Catalog Number	Tip	Length (in.)
BD043R	SERR	4 1/2
BD045R	SERR	5 1/8
BD047R	SERR	5 3/4
BD049R	SERR	6 1/4
BD050R	SERR	7
BD051R	SERR	7 7/8
BD052R	SERR	9 3/4
BD053R	SERR	11 3/4

Dressing Forceps, Extra Wide

Catalog Number	Tip	Length (in.)
BD077R	SERR	5 3/4



BD023R-BD033R

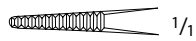

BD023R



BD025R



BD027R



BD029R

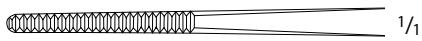

BD033R



BD035R-BD037R

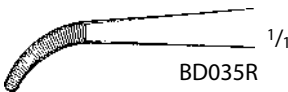

BD035R



BD037R



BD210R



BD210R

Dressing Forceps, Delicate

Catalog Number	Tip	Length (in.)
BD023R	STR, SERR	4 1/2
BD025R	STR, SERR	5 1/8
BD027R	STR, SERR	5 3/4
BD029R	STR, SERR	6 1/4
BD033R	STR, SERR	12
BD035R	CVD, SERR	5 1/8
BD037R	CVD, SERR	5 1/2

Dressing Forceps, Extra Delicate

Catalog Number	Tip	Length (in.)
BD210R	SERR	4 1/2

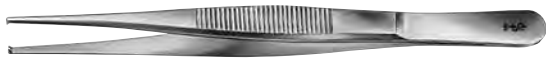

BD533R-BD543R

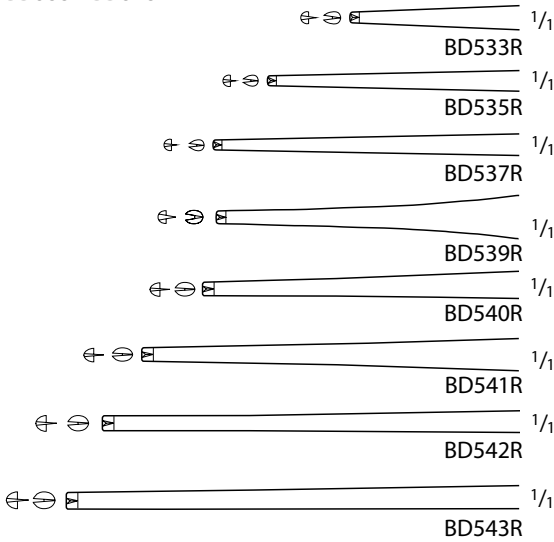

MB803R

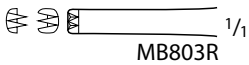

BD575R-BD581R

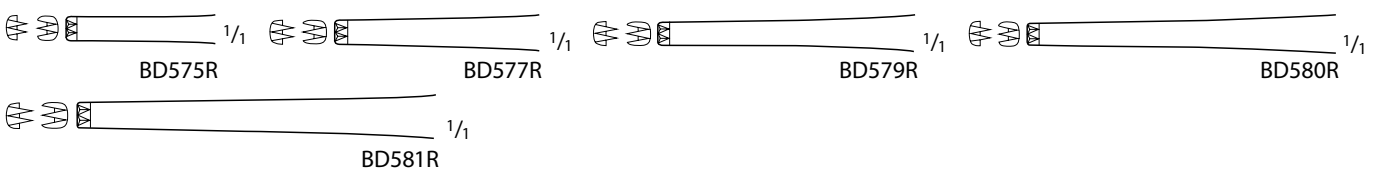

BD587R-BD591R

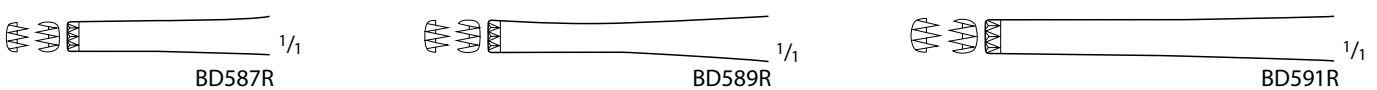

BD527R



BD547R-BD549R

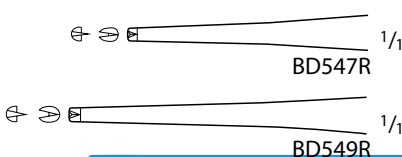

Tissue Forceps, Delicate

Catalog Number	Tip	Teeth	Length (in.)
BD533R	STR	1 x 2	4 1/2
BD535R	STR	1 x 2	5 1/8
BD537R	STR	1 x 2	5 3/4
BD539R	STR	1 x 2	6 1/4
BD540R	STR	1 x 2	7
BD541R	STR	1 x 2	7 7/8
BD542R	STR	1 x 2	9 3/4
BD543R	STR	1 x 2	11 3/4
MB803R	STR	2 x 3	4 1/2
BD575R	STR	2 x 3	5 1/8
BD577R	STR	2 x 3	5 3/4
BD579R	STR	2 x 3	6 1/4
BD580R	STR	2 x 3	7
BD581R	STR	2 x 3	7 7/8
BD587R	STR	3 x 4	5 3/4
BD589R	STR	3 x 4	6 1/4
BD591R	STR	3 x 4	7 7/8
BD527R	CVD	1 x 2	5 3/4

Tissue Forceps, Medium

Catalog Number	Teeth	Length (in.)
BD547R	1 x 2	5 3/4
BD549R	1 x 2	6 1/4



BD553R-BD563R

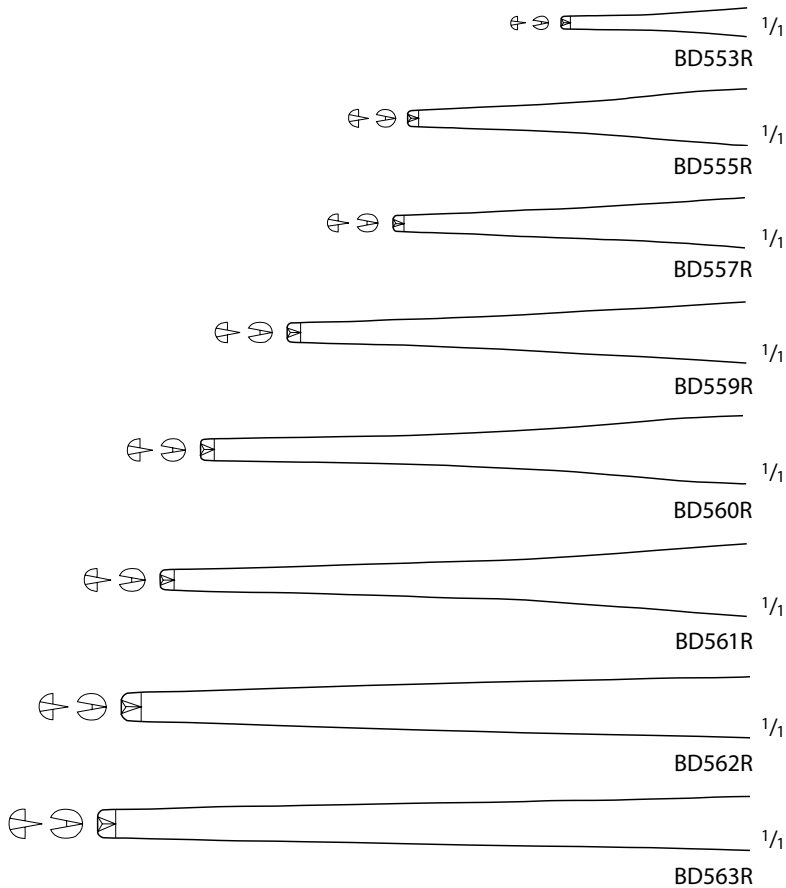

Tissue Forceps, Standard Patterns

Catalog Number	Teeth	Length (in.)
BD553R	1 x 2	4 1/2
BD555R	1 x 2	5 1/8
BD557R	1 x 2	5 3/4
BD559R	1 x 2	6 1/4
BD560R	1 x 2	7
BD561R	1 x 2	7 7/8
BD562R	1 x 2	9 3/4
BD563R	1 x 2	11 3/4



BD690R-BD692R



BD690R

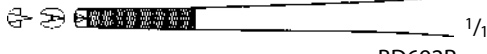

BD692R

STRASSBURGER Tissue Forceps

Catalog Number	Tip	Teeth	Length (in.)
BD690R	X-SERR	1 x 2	6
BD692R	X-SERR	1 x 2	7 7/8



MG077R



MG077R

CURTIS Tissue Forceps

Catalog Number	Tip	Length (in.)
MG077R	SERR	8 3/4



BD693R



BD693R



MG357R



MG357R

BONNEY Tissue Forceps

Catalog Number	Tip	Teeth	Length (in.)
BD693R	SERR	1 x 2	6 7/8
MG357R	SERR	2 x 3	6 3/4



BD733R

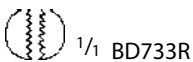

1/1 BD733R

MARTIN Tissue Forceps

Catalog Number	Teeth	Length (in.)
BD733R	7 x 8	6 1/8



MB224



MB224



MG464R-MG465R



MG464R



MG465R



BD725R-BD727R

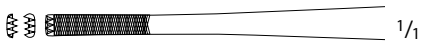

BD725R

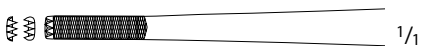

BD726R

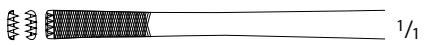

BD727R



BD755R

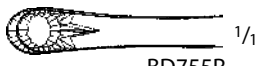

BD755R



BD760R-BD761R, MB921R-MB922R, XG006R

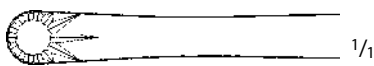

BD760R



BD761R, MB921R, MB922R

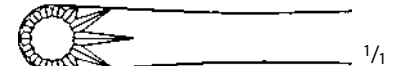

XG006R

HEANEY Tissue Forceps

Catalog Number	Tip	Teeth	Length (in.)
MG464R	X-SERR	1 x 2	7 1/4
MB224	X-SERR	2 x 3	5 1/2
MG465R	X-SERR	3 x 4	7 1/2

STILLE-BARRAYA CV Forceps

Catalog Number	Tip	Teeth	Length (in.)
BD725R	X-SERR	3 x 4	7
BD726R	X-SERR	3 x 4	7 7/8
BD727R	X-SERR	3 x 4	9 3/4

RUSSIAN Tissue Forceps

Catalog Number	Length (in.)
BD755R	6
BD760R	7 7/8
XG006R	9 3/4
BD761R	10 1/4
MB921R	12
MB922R	14



MB208R-MB923R



MAYO-RUSSIAN Tissue Forceps

Catalog Number	Tip	Length (in.)
MB208R	FENESTRATED	9
MB923R	FENESTRATED	14



BD750R

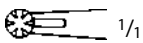

BD750R



MB795R



MB795R

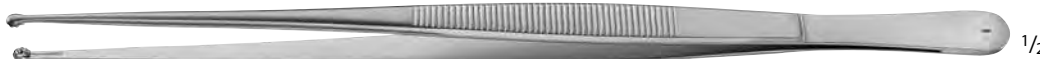

MG078R



MG078R

SELMAN Tissue Forceps

Catalog Number	Length (in.)
BD750R	6 1/8
MB795R	7 7/8
MG078R	9 3/4

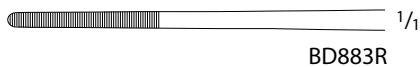
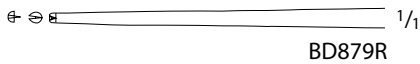
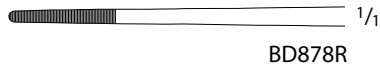

LUCAE Bayonet Forceps

Catalog Number	Tip	Teeth	Length (in.)
BD878R	SERR	-	5 1/2
BD879R	SMOOTH	1 x 2	5 1/2

GRUENWALD Bayonet Forceps

Catalog Number	Tip	Length (in.)
BD883R	SERR	7 7/8

CUSHING Bayonet Forceps

Catalog Number	Tip	Teeth	Length (in.)
US147	SERR	-	7 3/4
MB231	SMOOTH	1 x 2	7 1/4

BROWN-CUSHING Bayonet Forceps

Catalog Number	Teeth	Length (in.)
MB227	7 x 7	7 1/4



BD876R, MB804R



BD876R, MB804R

BROWN-BAHNSON Bayonet Forceps

Catalog Number	Tip	Length (in.)
BD876R	SERR	6 1/8
MB804R	SERR	8



BD880R, MB236



BD880R



MB236

JANSEN Bayonet Forceps

Catalog Number	Tip	Length (in.)
BD880R	SERR	6 1/4
MB236	SERR	6 1/2



BD885R



BD885R



BD886R



BD886R

Bayonet Forceps

Catalog Number	Tip	Teeth	Length (in.)
BD885R	SMOOTH	-	7 1/4
BD886R	SMOOTH	1 x 2	7 7/8



US104-US105

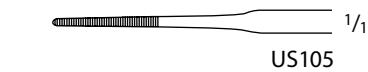

US105



US104

GERALD Bayonet Forceps

Catalog Number	Tip	Teeth	Length (in.)
US105	SERR	-	7 1/2
US104	SMOOTH	1 x 2	7 1/2

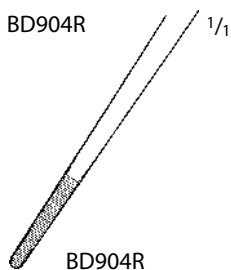
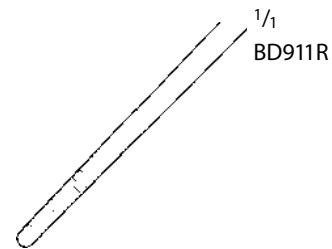
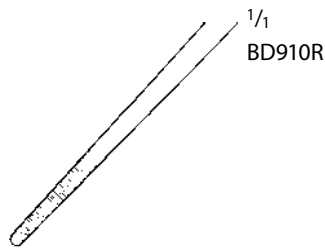
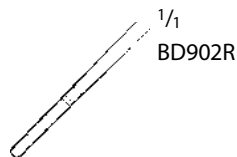
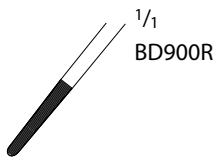

Bayonet Forceps

Catalog Number	Tip	Length (in.)
BD887R		6 1/4
FD110R	FINE	7 1/4
FD111R	BROAD	7 1/4

TROELTSCH Bayonet Forceps

Catalog Number	Tip	Length (in.)
BD900R	ANG/SERR	4
BD902R	ANG/SERR	4 1/2
BD910R	ANG/SERR	5 1/2
BD911R	ANG/SERR	6 3/4

WILDE Bayonet Forceps

Catalog Number	Tip	Length (in.)
BD904R	ANG/SERR	4 1/2



BD225R, MB291R



BD225R

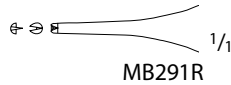

MB291R



BD610R-BD611R



BD610R



BD611R



BD215R-BD216R

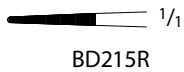

BD215R

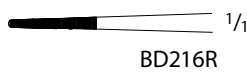

BD216R



BD665R-BD667R

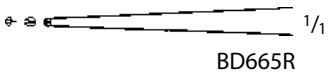

BD665R

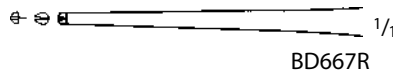

BD667R

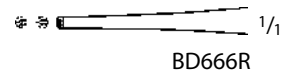

BD666R



BD220R

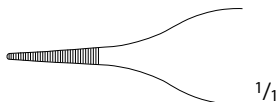

BD220R



BD223R

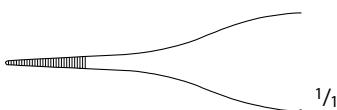

BD223R

HUDSON Forceps

Catalog Number	Tip	Teeth	Length (in.)
BD225R	SERR	-	5
MB291R	SMOOTH	1 x 2	5

FERRIS-SMITH Tissue Forceps

Catalog Number	Tip	Teeth	Length (in.)
BD610R	X-SERR	1 x 2	6 7/8
BD611R	X-SERR	2 x 3	6 7/8

SEMKEN Forceps, Delicate

Catalog Number	Tip	Teeth	Length (in.)
BD215R	SERR	-	5
BD216R	SERR	-	6
BD665R	SMOOTH	1 x 2	5
BD667R	SMOOTH	1 x 2	6
BD666R	SMOOTH	2 x 3	5

Micro ADSON Forceps, Delicate

Catalog Number	Tip	Length (in.)
BD220R	SERR, W/ PLATFORM	4 3/4
BD223R	SERR	6



BD222R, MA156R

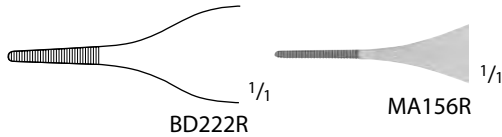

BD511R



MG275R



BD512R



MA536R



MB454R



BD506R



BD507R



BD508R



BD513R



BD521R

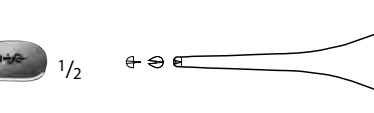
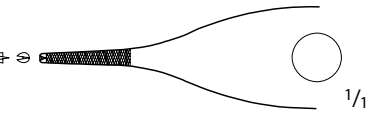
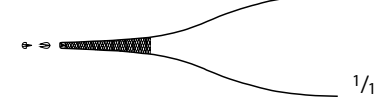
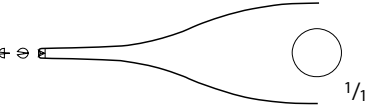
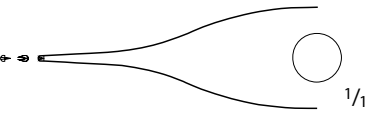
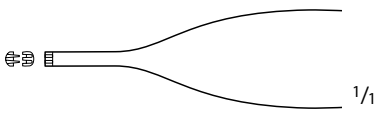
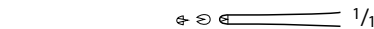
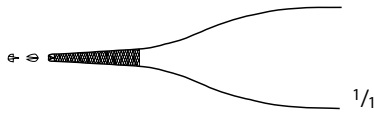
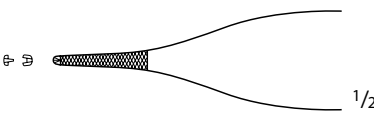
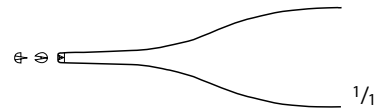

ADSON Forceps, Delicate

Catalog Number	Tip	Teeth	Handle	Length (in.)
BD222R	SERR	-	-	4 3/4
MA156R	SERR, X-LONG	-	-	4 3/4
BD511R	SMOOTH	1 x 2	-	4 3/4
MG275R	SERR	1 x 2	-	4 3/4
BD512R	X-SERR W/ PLATFORM	1 x 2	-	4 3/4
MA536R	X-LONG	1 x 2	-	4 3/4
MB454R	SMOOTH	2 x 3	-	4 3/4
BD506R	SMOOTH	1 x 2	FENE-STRATED	4 3/4
BD507R	SMOOTH	1 x 2	FENE-STRATED	4 3/4
BD508R	SERR	1 x 2	FENE-STRATED	4 3/4
BD513R	X-SERR W/ PLATFORM	1 x 2	FENE-STRATED	4 3/4
BD521R	SMOOTH	1 x 2	FENE-STRATED	6

Let Us know if you could not find what you are looking for

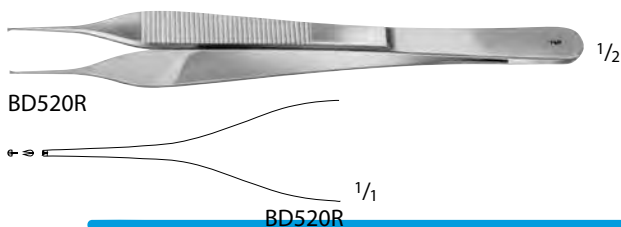
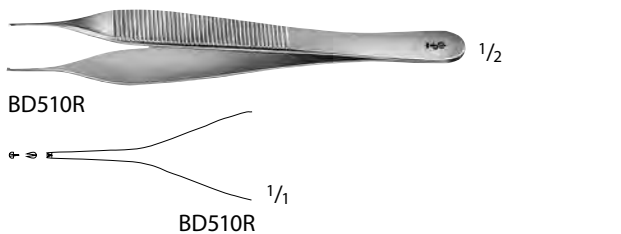
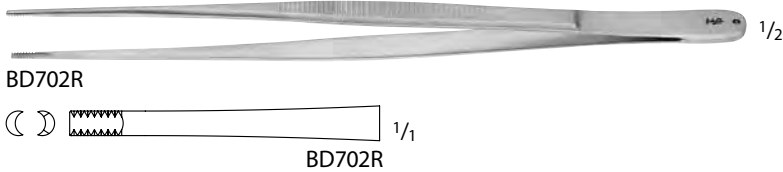
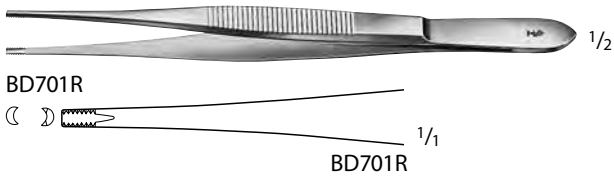
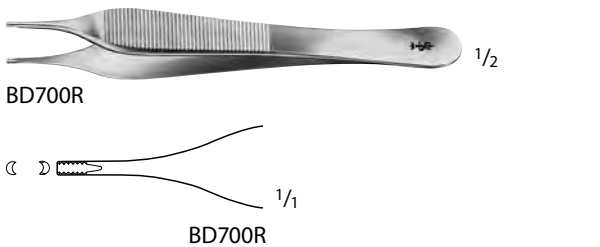
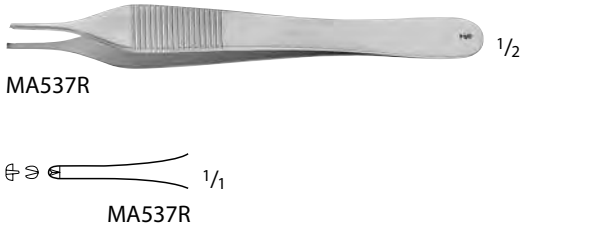
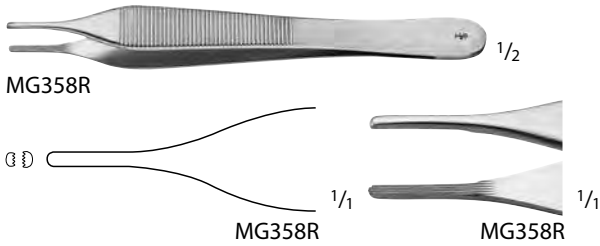

MUSTARDE Suture Removal Forceps

Catalog Number	Tip	Length (in.)
MG358R	LONGITUDINAL, SERR	5

CALLISON-ADSON Tissue Forceps, W/ Platform

Catalog Number	Teeth	Length (in.)
MA537R	1 x 2	5

ADSON-BROWN Tissue Forceps

Catalog Number	Teeth	Length (in.)
BD700R	7 x 8	4 3/4

BROWN Tissue Forceps

Catalog Number	Teeth	Length (in.)
BD701R	7 x 8	6
BD702R	7 x 8	7 7/8

MICRO ADSON Tissue Forceps, Delicate

Catalog Number	Teeth	Length (in.)
BD510R	1 x 2	4 3/4
BD520R	1 x 2	6



BD662R-BD664R

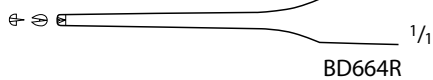
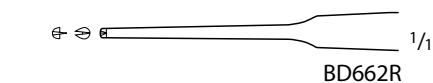

GERALD Tissue Forceps, Delicate

Catalog Number	Tip	Teeth	Length (in.)
BD662R	STR	1 x 2	6 7/8
BD664R	STR	1 x 2	9
BD663R	CVD	1 x 2	6 7/8



MG422R

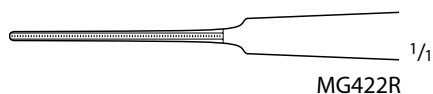

GERALD-DEBAKEY Forceps, Narrow

Catalog Number	Tip	Length (in.)
MG422R	SERR	9



BD522R

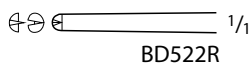

ADSON Tissue Forceps, Delicate

Catalog Number	Teeth	Length (in.)
BD522R	1 x 2	7



BD523R

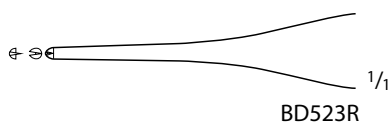

JEFFERSON Tissue Forceps, Delicate

Catalog Number	Teeth	Length (in.)
BD523R	1 x 2	7



BD228R-BD230R

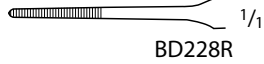

BD228R



BD230R

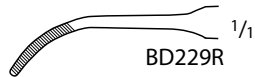

BD229R



BD236R

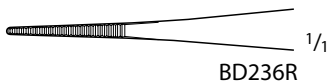

BD236R



BD661R

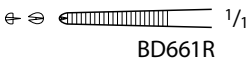

BD661R



BD257R

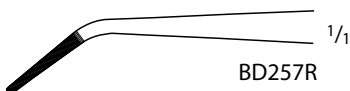

BD257R

GERALD Dressing Forceps, Delicate

Catalog Number	Tip	Length (in.)
BD228R	STR, SERR	6 7/8
BD230R	STR, SERR	9
BD229R	CVD, SERR	6 7/8

MCINDOE Thumb Forceps, Delicate

Catalog Number	Tip	Length (in.)
BD236R	SERR	6

MCINDOE Tissue Forceps, Delicate

Catalog Number	Tip	Teeth	Length (in.)
BD661R	SERR	1 x 2	6

Delicate Forceps, Angled

Catalog Number	Tip	Length (in.)
BD257R	SERR	7 7/8



BD238R-BD243R

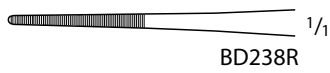

BD238R



BD239R

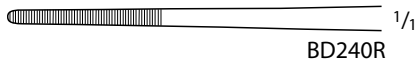

BD240R



BD243R



MD463

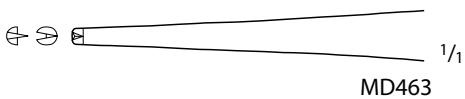

MD463



BD246R

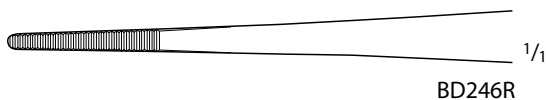

BD246R

CUSHING Forceps, Delicate

Catalog Number	Tip	Length (in.)
BD238R	STR, SERR	7
BD239R	STR, SERR	7 7/8
BD240R	STR, SERR	9 3/4
BD243R	CVD, SERR	7 7/8

CUSHING Tissue Forceps

Catalog Number	Teeth	Length (in.)
MD463	1 x 2	7

BROPHY Forceps, Delicate

Catalog Number	Tip	Length (in.)
BD246R	SERR	7 7/8



BD231R-BD232R

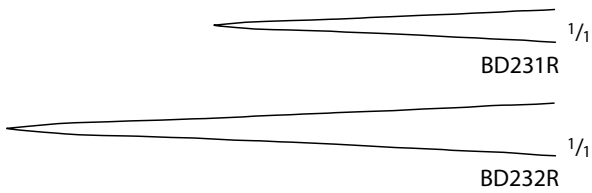

Forceps, Delicate

Catalog Number	Tip	Length (in.)
BD231R	SMOOTH	7
BD232R	SMOOTH	7 7/8



BD301R-BD305R

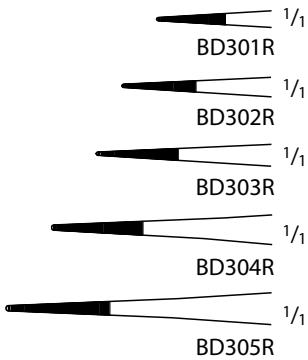

Micro Dressing Forceps

Catalog Number	Tip	Length (in.)
BD301R	STR, SERR	3 1/2
BD302R	STR, SERR	4 1/8
BD303R	STR, SERR	4 1/2
BD304R	STR, SERR	5 1/8
BD305R	STR, SERR	5 3/4
BD311R	CVD, SERR	3 1/2
BD312R	CVD, SERR	4 1/8
BD313R	CVD, SERR	4 1/2
BD314R	CVD, SERR	5 1/8
BD315R	CVD, SERR	5 3/4



BD311R-BD315R

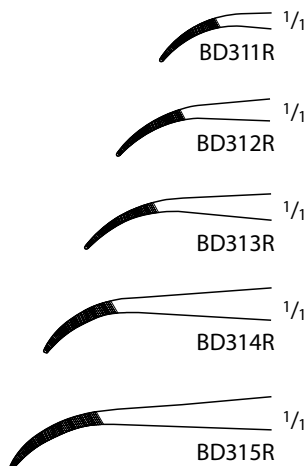

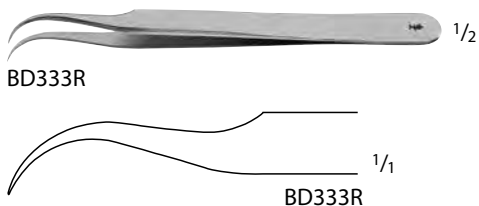
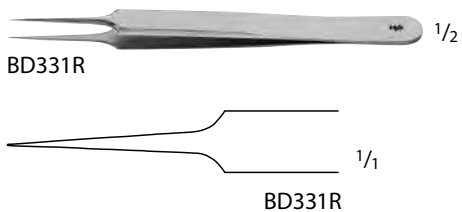
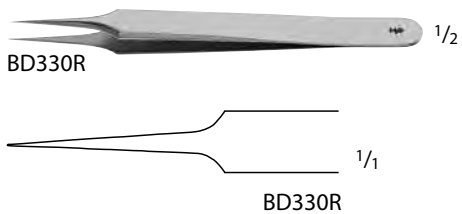
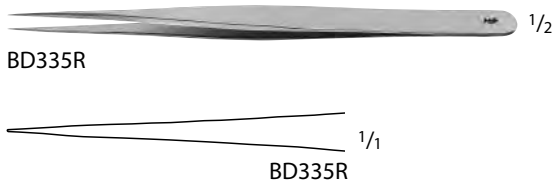
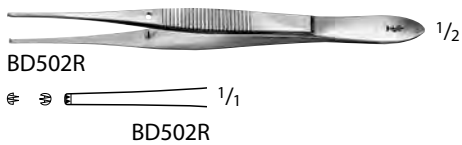
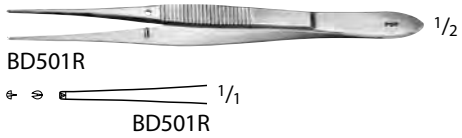
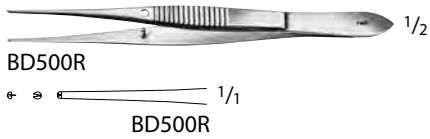

Micro Tissue Forceps

Catalog Number	Teeth	Length (in.)
BD500R	1 x 2	4
BD501R	1 x 2	4 1/4
BD502R	2 x 3	4 1/4

Micro Forceps #3 Jewelers

Catalog Number	Tip Size (mm)	Length (in.)
BD335R	0.3	5 1/4

Micro Forceps #4 Jewelers

Catalog Number	Tip Size (mm)	Length (in.)
BD330R	0.2	4 1/4

Micro Forceps #5 Jewelers

Catalog Number	Tip Size (mm)	Length (in.)
BD331R	0.15	4 1/4

Micro Forceps #7 Jewelers

Catalog Number	Tip Size (mm)	Length (in.)
BD333R	0.2	4 1/2



BD660R



BD660R



BD669R



BD669R



BD670R-BD679R

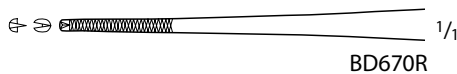

BD670R



BD671R

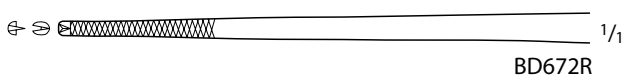

BD672R

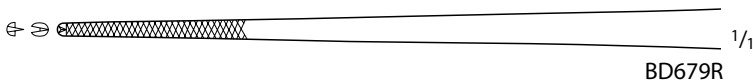

BD679R



MB211R



MB211R

GILLIES Tissue Forceps, Delicate

Catalog Number	Tip	Teeth	Length (in.)
BD660R	X-SERR	1 x 2	6 1/8

SEMKEN Tissue Forceps, Delicate

Catalog Number	Teeth	Length (in.)
BD669R	1 x 2	5 3/4

WAUGH Tissue Forceps, Delicate

Catalog Number	Tip	Teeth	Length (in.)
BD670R	X-SERR	1 x 2	7
BD671R	X-SERR	1 x 2	7 7/8
BD672R	X-SERR	1 x 2	9 3/4
BD679R	X-SERR	1 x 2	12

DOCKTOR Forceps

Catalog Number	Tip	Teeth	Length (in.)
MB211R	X-SERR	1 x 2	4 3/4

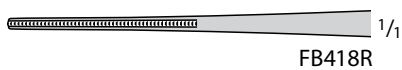
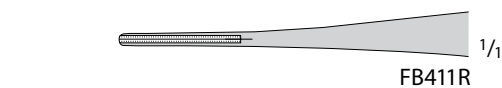
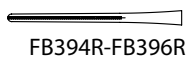
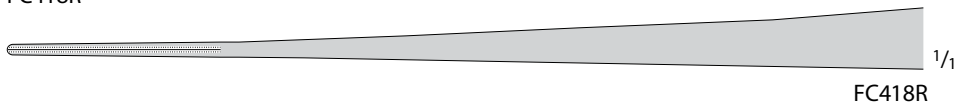
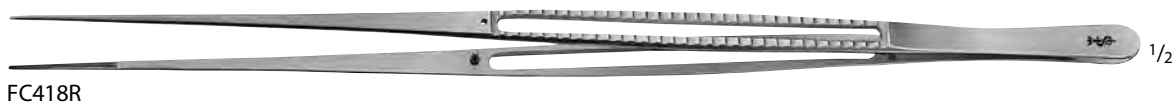
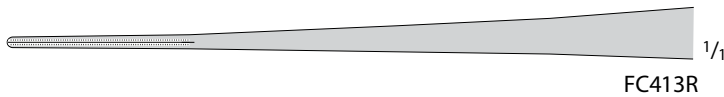

DEBAKEY Atraumatic Ultra Light Forceps

Catalog Number	Tip Size (mm)	Length (in.)
FC411R	1.2	6
FC412R	1.5	7 7/8
FC413R	1.5	9 1/2
FC418R	1.5	11 3/4

DEBAKEY Atraumatic Vascular Tissue Forceps

Catalog Number	Tip Size (mm)	Length (in.)
FB394R	1	6
FB395R	1	7 3/4
FB396R	1	9 1/2

DEBAKEY Atraumatic Forceps

Catalog Number	Tip Size (mm)	Length (in.)
FB411R	1.5	6
FB412R	1.5	7 7/8
FB418R	1.5	9 1/2
FB419R	1.5	11 3/4



FB400R-FB409R



FB400R



FB402R



FB404R



FB405R



FB414R



FB415R



FB416R



FB417R

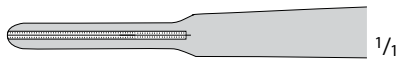

FB406R



FB407R



FB408R



FB409R

DEBAKEY Atraumatic Forceps

Catalog Number	Tip Size (mm)	Length (in.)
FB400R	2	6
FB402R	2	7 7/8
FB404R	2	9 1/2
FB405R	2	11 3/4
FB414R	2.8	6
FB415R	2.8	7 7/8
FB416R	2.8	9 1/2
FB417R	2.8	11 3/4
FB406R	3.5	7 7/8
FB407R	3.5	9 1/2
FB408R	3.5	11 3/4
FB409R	3.5	13 3/4



FB401R-FB410R

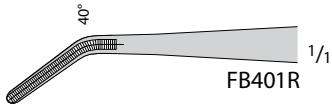

FB401R

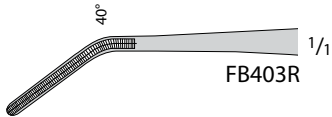

FB403R

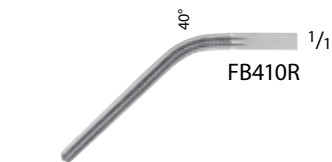

FB410R

DEBAKEY Atraumatic Forceps, Angled

Catalog Number	Tip Size (mm)	Length (in.)
FB401R	2	6
FB403R	2	7 7/8
FB410R	2	9 1/2



FB784R



FB784R



FB785R



FB785R



FB786R



FB786R

COOLEY Atraumatic Vascular Tissue Forceps

Catalog Number	Tip Size (mm)	Length (in.)
FB784R	1.5	6
FB785R	2.0	7 3/4
FB786R	2.3	9 1/2



BD250R



BD250R

COOLEY Vascular Tissue Forceps

Catalog Number	Length (in.)
BD250R	7 7/8



BD770R

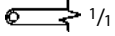

BD770R

MILLS Mammary/Coronary Tissue Forceps

Catalog Number	Length (in.)
BD770R	7



FB130R



Dilator Forceps

Catalog Number	Tip Size (mm)	Length (in.)
FB130R	0.2	4 1/2



BD980R



HUNTER Splinter Forceps

Catalog Number	Length (in.)
BD980R	4 1/8

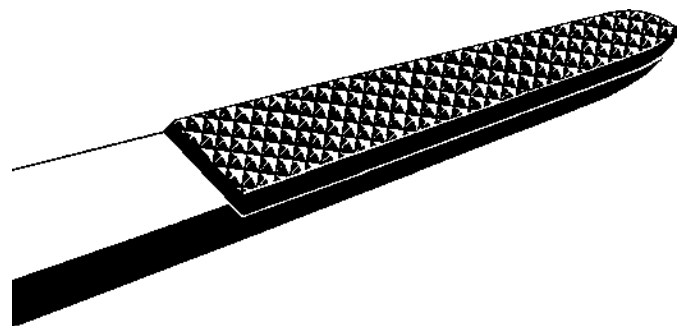

DUROGRIP Tungsten Carbide Tissue Forceps

- Cross-Serrated Platform tips for firm and non-traumatic grip
- Long working life
- Gold-plated end



BD151R

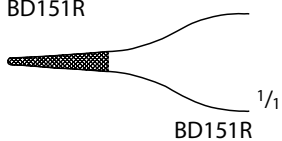

BD151R



US109-US110

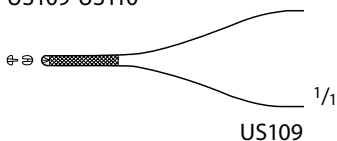

US109

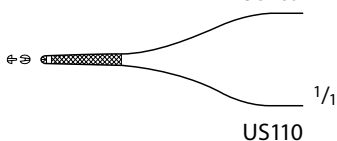

US110



MB484R-MB485R



MB484R



MB485R



US112

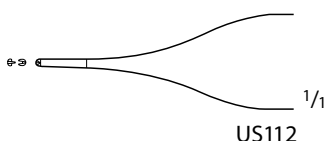

US112

DUROGRIP TC ADSON Forceps

Catalog Number	Tip	Teeth	Length (in.)
BD151R	X-SERR	-	4 3/4
US109	X-SERR	1 x 2	4 3/4
US110	DEL, X-SERR	1 x 2	4 3/4
MB484R	X-SERR	1 x 2	6
MB485R	DEL, X-SERR	1 x 2	6

DUROGRIP TC GORNEY-ADSON Forceps

Catalog Number	Tip	Teeth	Length (in.)
US112	DEL, SMOOTH	1 x 2	4 3/4



MB782R



MB782R



MB783R



MB783R



MB779R-MB781R, US117-US120



MB779R



MB780R



MB781R



US117



US118

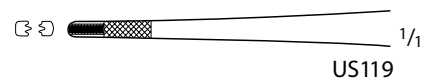

US119

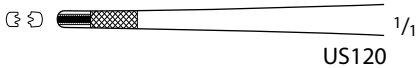

US120



MG356R

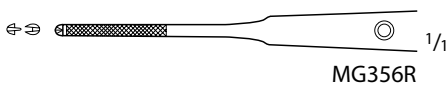

MG356R



BD154R-BD156R

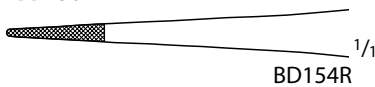

BD154R

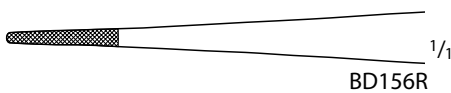

BD156R



BD157R-BD159R

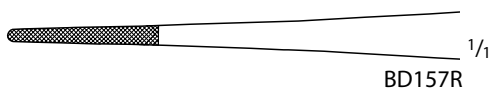

BD157R

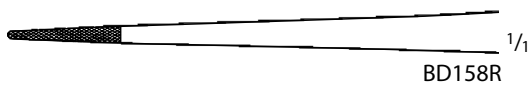

BD158R



BD159R

DUROGRIP TC DEBAKEY Needle Forceps

Catalog Number	Tip	Tip Size (mm)	Length (in.)
MB782R	-	1.5	6
MB783R	-	1.5	7 3/4
US119	NARROW	1.5	7 3/4
MB779R	-	2	6
MB780R	-	2	8
MB781R	-	2	10 1/2
US117	-	2	6
US118	-	2	8
US120	NARROW	2	9

GERALD Needle Forceps

Catalog Number	Tip	Teeth	Length (in.)
MG356R	X-SERR	1 x 2	6 7/8

DUROGRIP TC (POTTS-SMITH) Thumb Forceps

Catalog Number	Tip	Length (in.)
BD154R	X-SERR	5 3/4
BD156R	X-SERR	7
BD157R	X-SERR	7 7/8
BD158R	X-SERR	9
BD159R	X-SERR	9 3/4



BD160R-BD198R

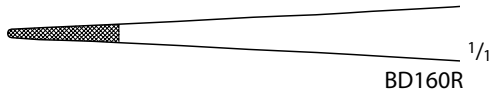

BD160R



BD198R

**DUROGRIP TC CUSHING Forceps,
 W/ Scraper End**

Catalog Number	Tip	Length (in.)
BD160R	X-SERR	7
BD198R	X-SERR	9 3/4



MB308R

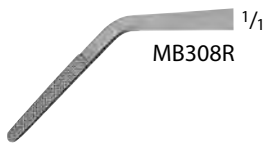

MB308R

DUROGRIP TC CUSHING Forceps

Catalog Number	Tip	Length (in.)
MB308R	ANG, X-SERR	6 1/4



US111



US111

DUROGRIP TC SEMKEN Forceps

Catalog Number	Tip	Tip Size (mm)	Teeth	Length (in.)
US111	X-SERR	1	1 x 2	6 1/4



BD164R-BD166R

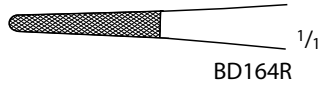

BD164R



BD165R

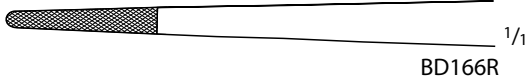

BD166R

DUROGRIP TC STANDARD Forceps

Catalog Number	Tip	Length (in.)
BD164R	X-SERR	5 3/4
BD165R	X-SERR	7 7/8
BD166R	X-SERR	9 3/4



BD168R

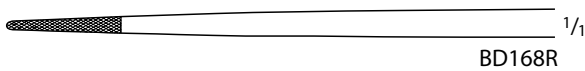

BD168R

DUROGRIP TC GRUENWALD Forceps

Catalog Number	Tip	Length (in.)
BD168R	X-SERR	7 1/4



BD171R-BD173R

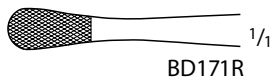

BD171R



BD173R

DUROGRIP TC WANGENSTEEN Forceps

Catalog Number	Tip	Length (in.)
BD171R	X-SERR	6
BD173R	X-SERR	9

LAHEY Forceps

Catalog Number	Teeth	Length (in.)
BF309R	2 x 2	6 1/8
BF310R	3 x 3	6 1/8
MG360R	3 x 3	8
BF311R	4 x 4	6 1/8

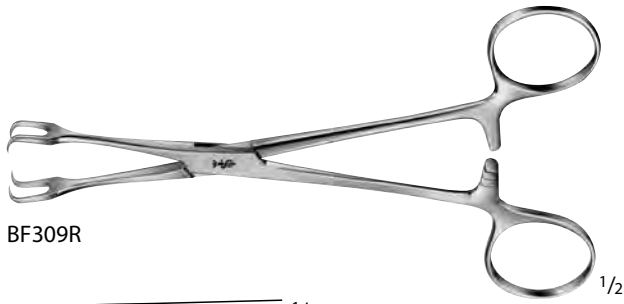

BF309R

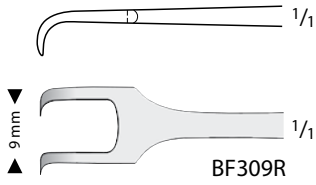

BF309R

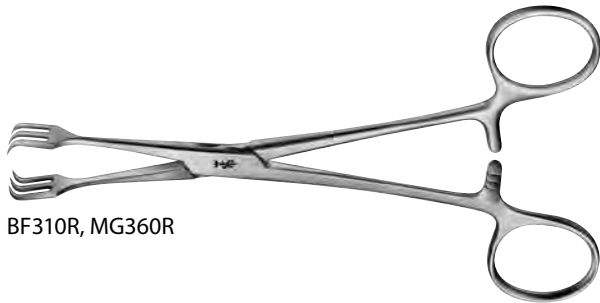

BF310R, MG360R

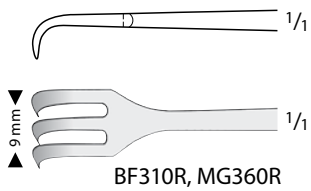

BF310R, MG360R



BF311R

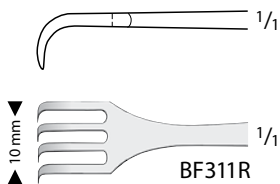

BF311R

BOYS-ALLIS Forceps

Catalog Number	Teeth	Length (in.)
EA010R	5 x 6	6 1/8



Baby ALLIS Forceps

Catalog Number	Teeth	Length (in.)
EA012R	4 x 5	5 1/8

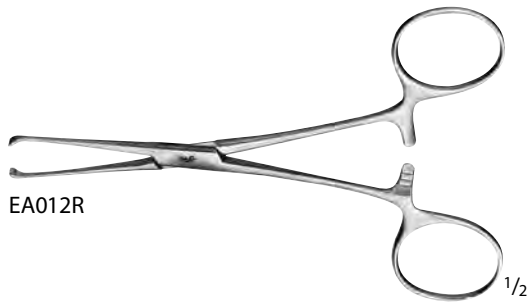

ALLIS Forceps

Catalog Number	Teeth	Length (in.)
EA015R	4 x 5	6 1/8
EA016R	5 x 6	6 1/8
EA017R	5 x 6	7 1/2
FB938R	5 x 6	8 3/4
EA018R	5 x 6	10
MB910R	5 x 6	16



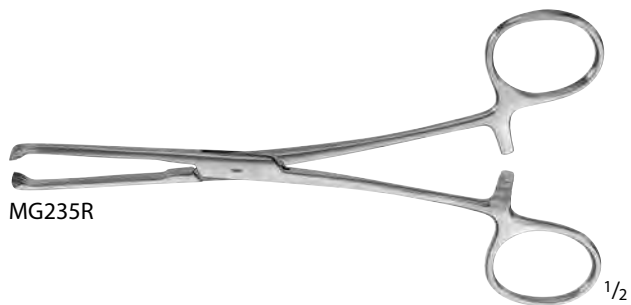

MG235R

1/2



MG235R

1/1

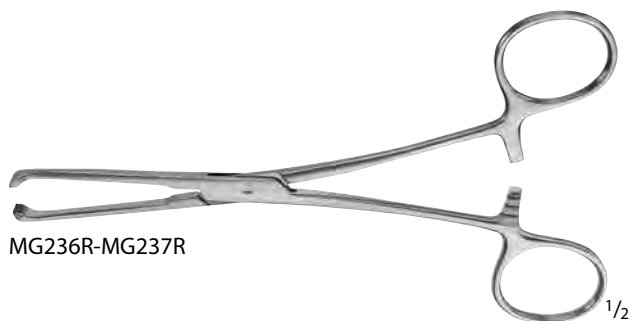

MG236R-MG237R

1/2



MG236R-MG237R

1/1



EA020R

1/2



EA020R

1/1

ALLIS Forceps, Heavy Version

Catalog Number	Teeth	Length (in.)
MG235R	4 x 5	6 1/8
MG236R	5 x 6	6 1/8
MG237R	5 x 6	7 7/8

ALLIS-THOMS Forceps

Catalog Number	Teeth	Length (in.)
EA020R	6 x 7	7 7/8

JUDD-ALLIS Forceps

Catalog Number	Teeth	Length (in.)
EA025R	3 x 4	6 1/8
EA026R	3 x 4	7 7/8

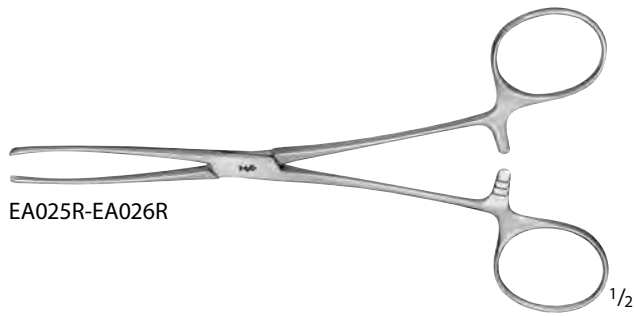

EA025R-EA026R



EA025R



EA026R

ALLIS-ADAIR Clamp

Catalog Number	Teeth	Length (in.)
MD568	9 x 10	6 1/4



MD568

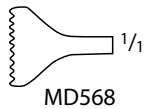

MD568

LOCKWOOD-ALLIS Intestinal Clamp

Catalog Number	Teeth	Length (in.)
MG455R	4 x 5	6 1/2

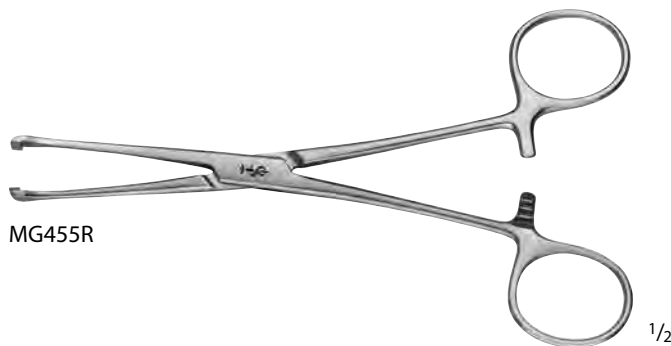

MG455R



MG455R



EA092R-EA099R

ALLIS Atraumatic Forceps

Catalog Number	Length (in.)
EA092R	6 1/4
EA095R	7 7/8
EA096R	8 3/4
EA097R	10
EA100R	11 5/8
EA099R	11 3/4
EA101R	14



EA092R



EA095R



EA096R



EA097R



EA099R



EA100R-EA101R

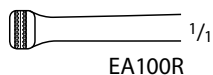

EA100R



EA101R

GLASSMAN-ALLIS Common Duct
 Forceps Non-Crushing

Catalog Number	Length (in.)
MG435R	8 1/2

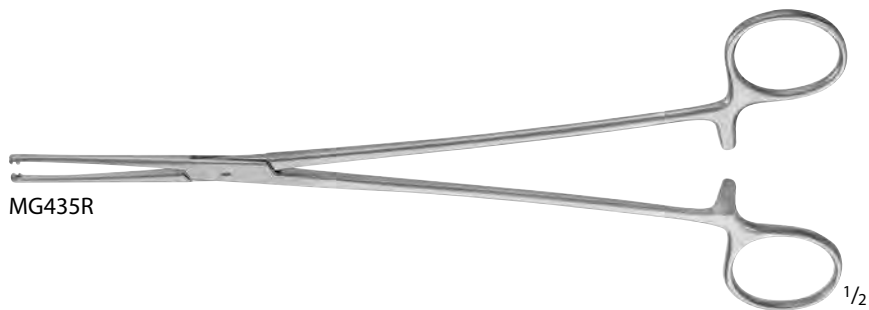

MG435R

1/2



MG435R

BABCOCK Tissue Holding Forceps

Catalog Number	Length (in.)
MB136R	12
MB137R	14



MB136R-MB137R

1/2



MB136R

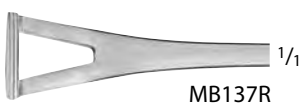

MB137R



EA030R-MG359R



MG359R



EA030R



EA031R



EA032R



FB934R, MB911R, MG300R



FB934R, MB911R, MG300R

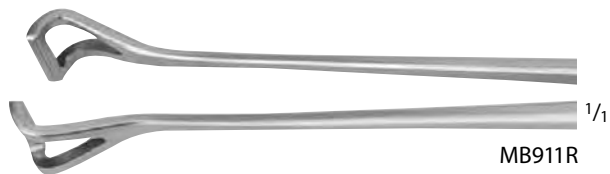

MB911R

BABCOCK Forceps

Catalog Number	Tip	Length (in.)
MG359R	-	5 1/2
EA030R	-	6 1/8
EA031R	-	6 7/8
EA032R	-	8 1/2
FB934R	-	8 3/4
MB300R	-	14
MB911R	DEL, PETITE	16

BABCOCK Atraumatic Forceps

Catalog Number	Length (in.)
EA050R	6 1/4
EA052R	8 1/2
FB936R	8 3/4
MD470	9 1/2

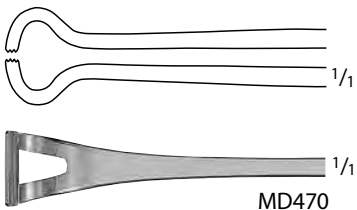
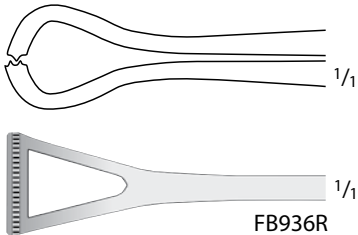
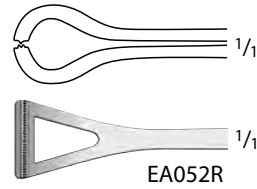
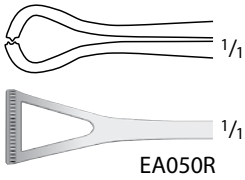
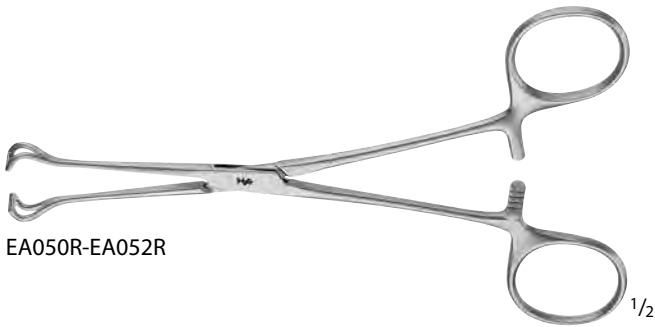



MG364R

1/2



MG364R

1/1



MB338R

1/2



MB338R

1/1



EA022R-EA023R



EA022R

1/1



EA023R

1/1

DUROGRIP™ TC BABCOCK Forceps

Catalog Number	Length (in.)
MG364R	6 1/4
MB338R	8 1/4

ALLIS Intestinal Grasping Forceps

Catalog Number	Length (in.)
EA022R	7 1/2
EA023R	11 1/2

COLLIN Intestinal Forceps

Catalog Number	Length (in.)
EA039R	5 1/2
EA040R	7



EA039R

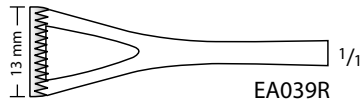

EA039R



EA040R

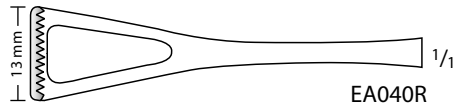

EA040R

COLLIN Atraumatic Forceps

Catalog Number	Length (in.)
EA061R	7 3/4
EA062R	9

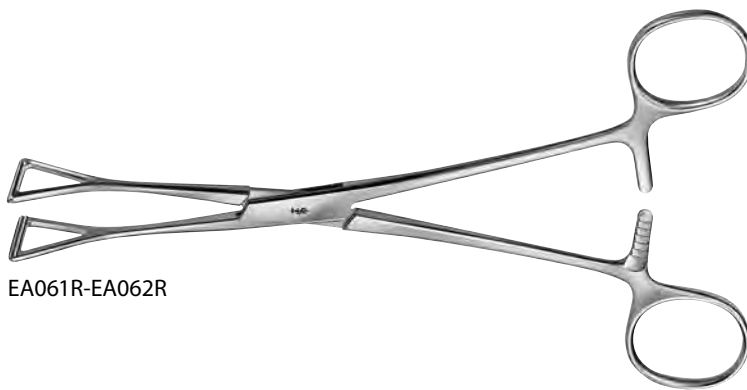

EA061R-EA062R

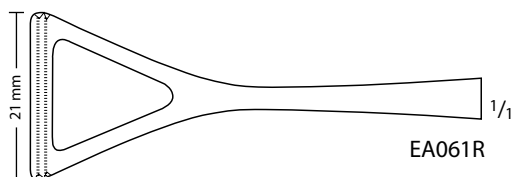

EA061R

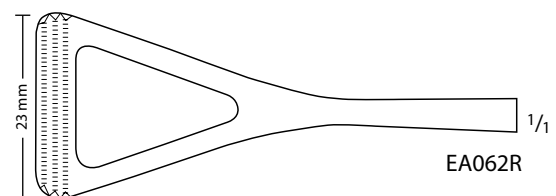

EA062R



EA041R-EA042R

DUVAL-COLLIN Intestinal Forceps

Catalog Number	Length (in.)
EA041R	7 3/4
EA042R	7 7/8

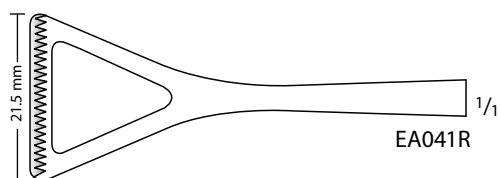

EA041R

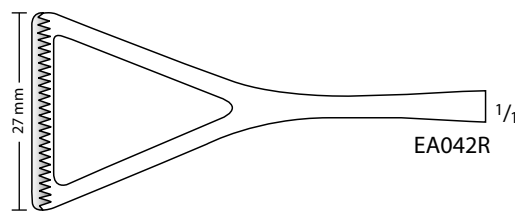

EA042R



BH902R

PENNINGTON Forceps

Catalog Number	Length (in.)
BH902R	6 1/8
EA037R	7 7/8

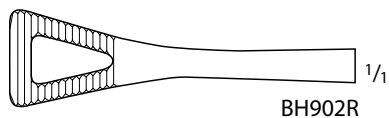

BH902R



EA037R

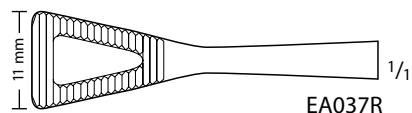

EA037R

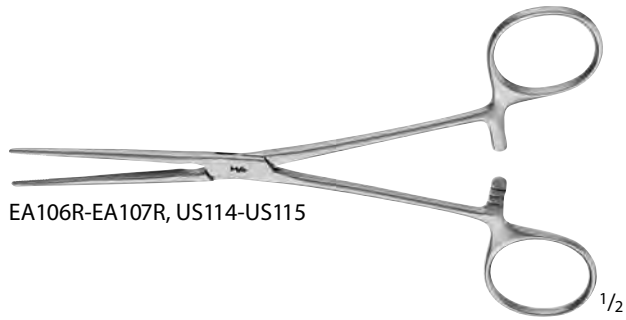

EA106R-EA107R, US114-US115

1/2



EA106R

1/1



US114

1/1

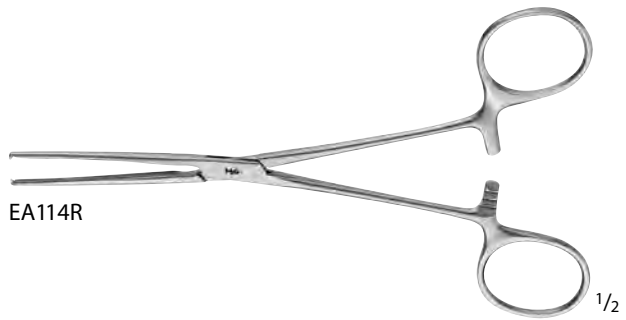

EA114R

1/2



EA114R

1/1



MB609R

1/2



MB609R

1/1

BAINBRIDGE Intestinal Forceps,
 Longitudinal Serrations

Catalog Number	Jaw	Length (in.)
EA106R	STR	6 1/8
US114	STR	7 1/4
EA107R	CVD	6 1/8
US115	CVD	7 1/4



EA107R

1/1



US115

1/1

ALLEN Intestinal Forceps, Longitudinal
 Serrated

Catalog Number	Teeth	Length (in.)
EA114R	1 x 2	6 1/8
MB609R	1 x 2	7 7/8

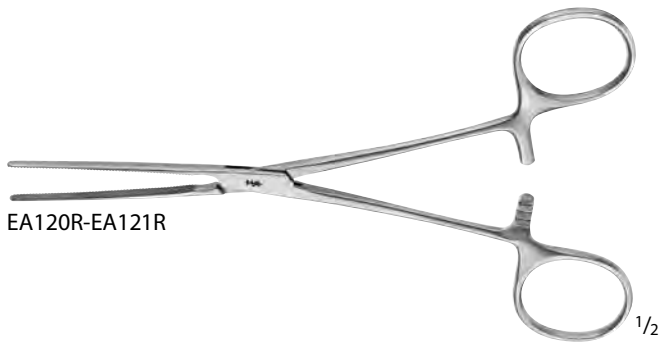

EA120R-EA121R



EA120R



EA121R

DOYEN Intestinal Forceps, Elastic
 Blades

Catalog Number	Jaw	Length (in.)
EA120R	STR	6 1/2
EA126R	STR	9 1/4
EA121R	CVD	6 1/2
EA127R	CVD	9 1/4



EA126R-EA127R



EA126R

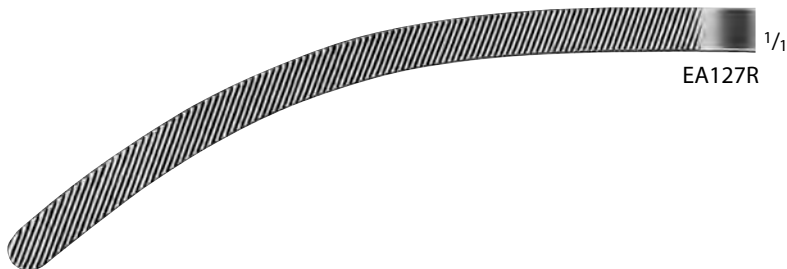

EA127R

DOYEN Intestinal Forceps, Elastic
 Blades, Longitudinal Seriations

Catalog Number	Jaw	Length (in.)
EA130R	STR	9 1/2
EA131R	CVD	9 1/2



EA130R-EA131R



EA130R



EA131R



EA124R-EA125R



EA124R



EA125R

HARTMANN Intestinal Clamp, Elastic
 Blades

Catalog Number	Jaw	Length (in.)
EA124R	STR	7 7/8
EA125R	CVD	7 7/8

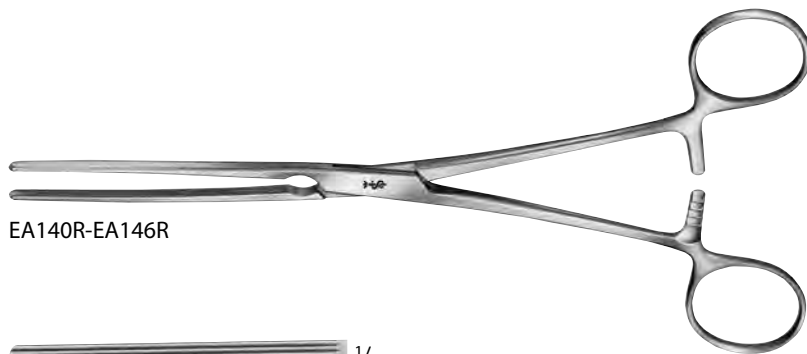

EA140R-EA146R



EA116R



EA140R



EA145R



EA117R



EA141R



EA146R

KOCHER Intestinal Forceps,
 Elastic Blades

Catalog Number	Jaw	Length (in.)
EA116R	STR	6 1/8
EA140R	STR	8 1/4
EA145R	STR	9
EA117R	CVD	5 1/4
EA141R	CVD	8 1/4
EA146R	CVD	9



EA150R-EA156R

KOCHER Intestinal Forceps, Elastic
 Blades

Catalog Number	Jaw	Length (in.)
EA150R	STR	8 3/4
EA151R	STR	9 3/4
EA152R	STR	11
EA155R	CVD	8 3/4
EA156R	CVD	9 3/4



EA150R



EA151R



EA152R



EA155R



EA156R

MAYO-ROBSON Intestinal Forceps,
 Hard Elastic Blades

Catalog Number	Jaw	Length (in.)
EA170R	STR	9 3/4
EA171R	CVD	9 3/4

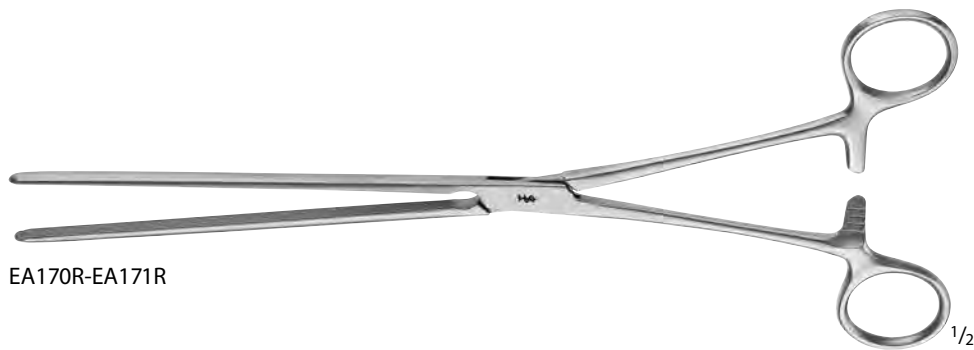

EA170R-EA171R



EA170R



EA171R

PAYR Intestinal Clamp

Catalog Number	Length (in.)
EA305R	7
EA306R	7 7/8
EA309R	10 3/4
EA450R	12 1/2



EA305R-EA450R

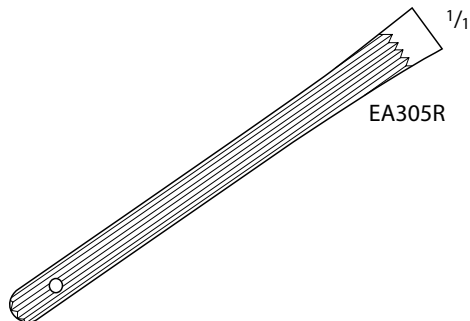

EA305R

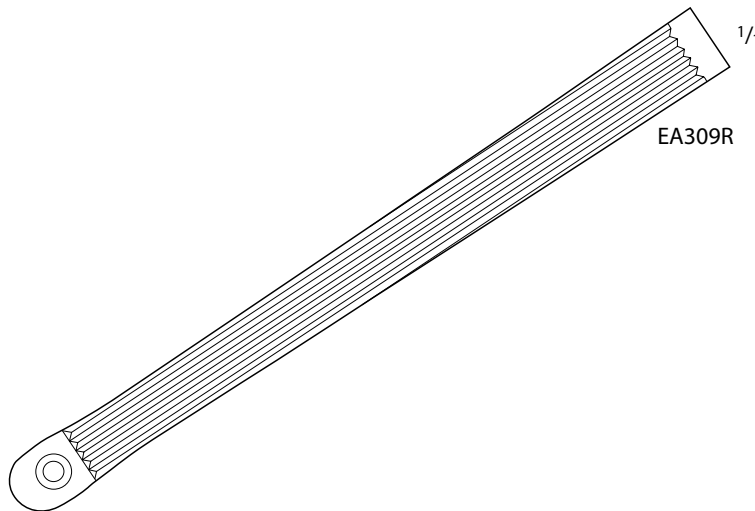

EA309R

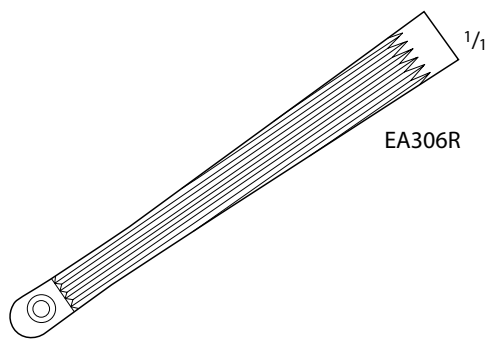

EA306R

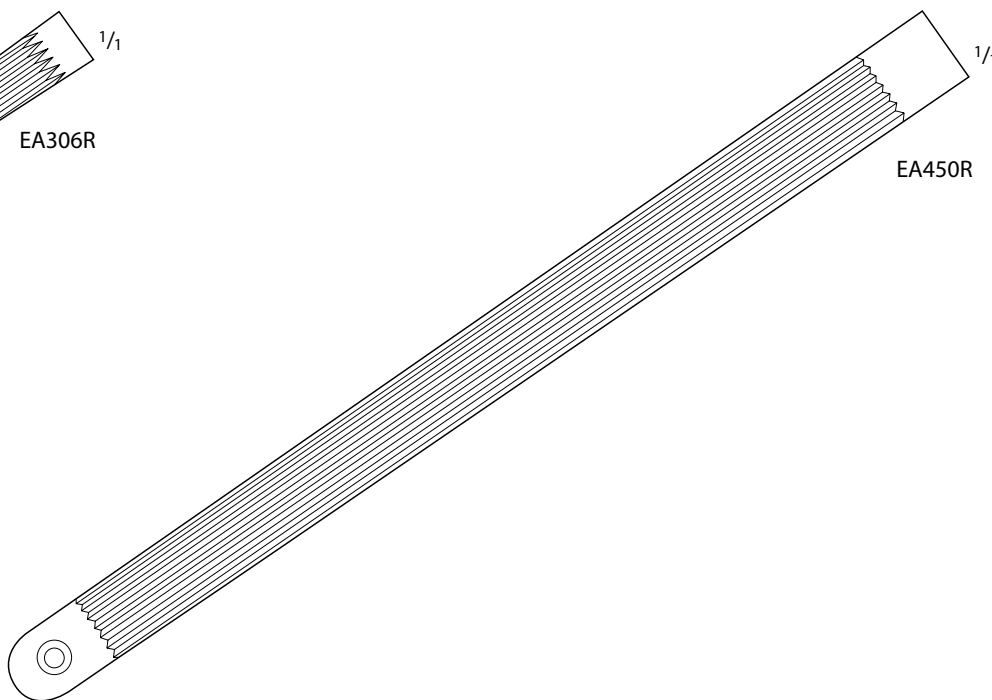

EA450R



EA331R-EA332R

DEMARTEL-WOLFSON Anastomosis
 Clamp

Catalog Number	Description	Length (in.)
EA331R	SET OF 3	4
EA332R	SET OF 3	4 3/4



EA334R

Clamp Holder for Anastomosis Clamp

Catalog Number	Description	Length (in.)
EA334R	3" FOR USE WITH EA331R-EA332R	3 1/8



EA334R

KLEINSCHMIDT Appendectomy Forceps

Catalog Number	Jaw	Length (in.)
EA397R	CVD	5 1/8



BENSON Pylorus Spreader

Catalog Number	Length (in.)
EA466R	6 1/8



TAUFIC Cholangiography Clamp

Catalog Number	Length (in.)
MG454R	8 1/2

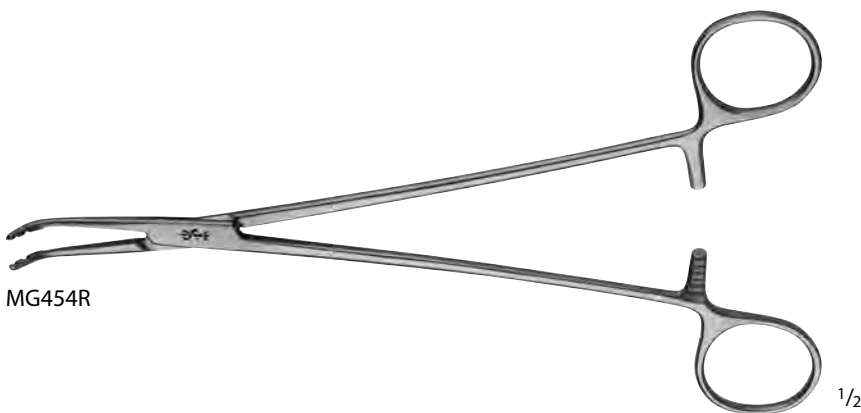

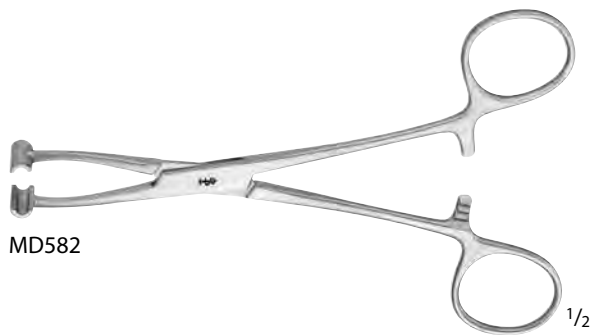

MD582



MD582

PRATT-SMITH Hemostatic "T" Forceps

Catalog Number	Length (in.)
MD582	6 1/8



EA323R

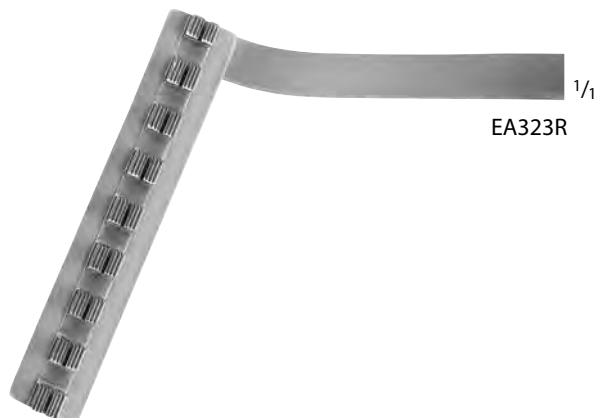

EA323R

Purse String Clamp

Catalog Number	Jaw Length (mm)	Length (in.)
EA323R	50	11

LOWER Gall Duct Forceps

Catalog Number	Jaw	Length (in.)
EB001R	HEAVY-CVD	7

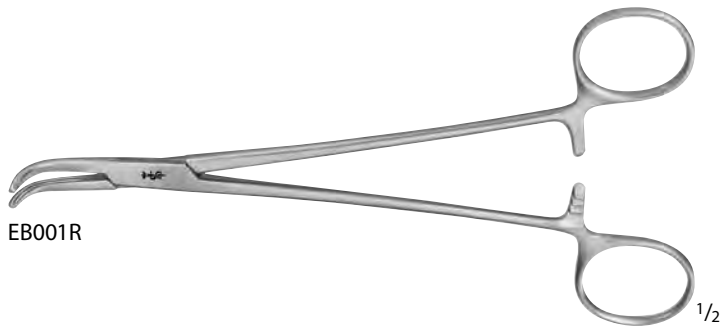

LAHEY (SWEET) Gall Duct Forceps

Catalog Number	Jaw	Length (in.)
EB003R	CVD	7 7/8

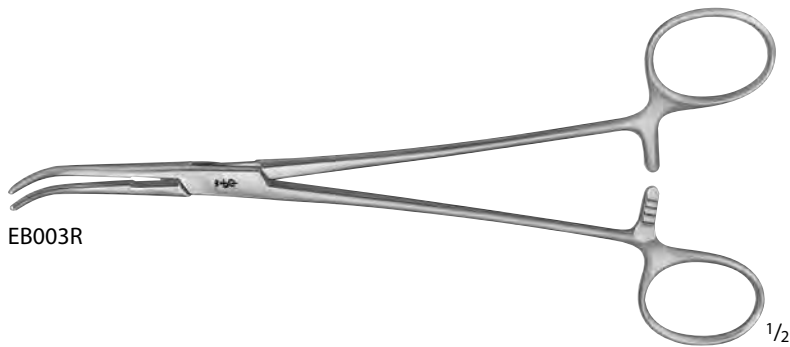

DESJARDINS Gall Duct Forceps

Catalog Number	Jaw	Length (in.)
EB008R	HEAVY-CVD	8 3/4

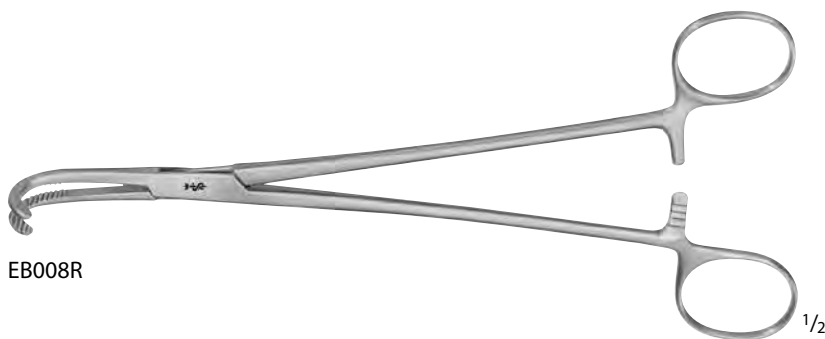

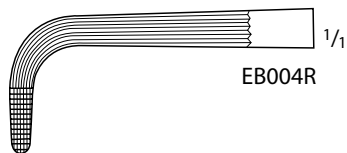

LAHEY Gall Duct Forceps

Catalog Number	Jaw	Length (in.)
EB004R	HEAVY-CVD	7 1/2

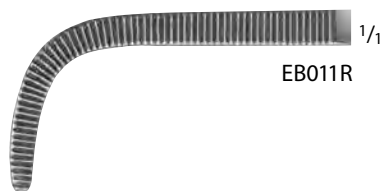
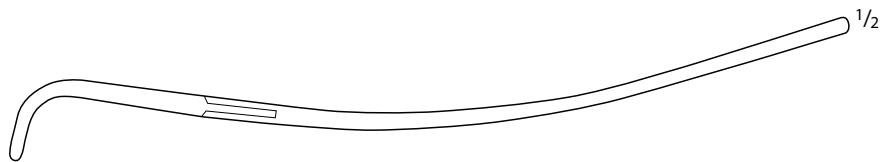
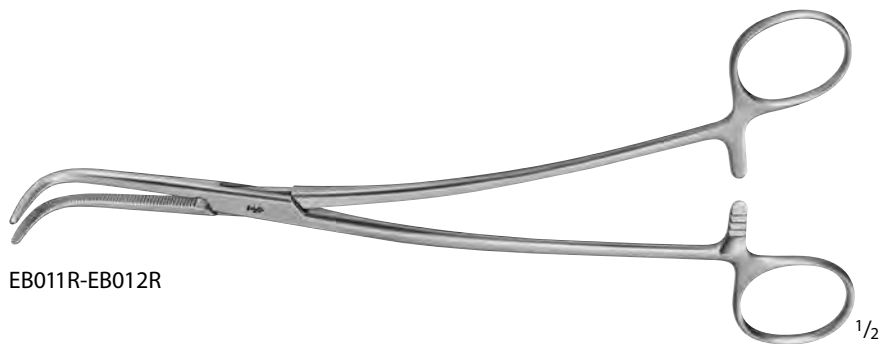

GRAY Cystic Gall Duct Forceps

Catalog Number	Jaw	Length (in.)
EB011R	SHORT, CVD	8 3/4
EB012R	LONG, CVD	8 3/4

MIXTER Gall Duct Forceps

Catalog Number	Jaw	Length (in.)
MB120R	HEAVY-CVD	6 1/4

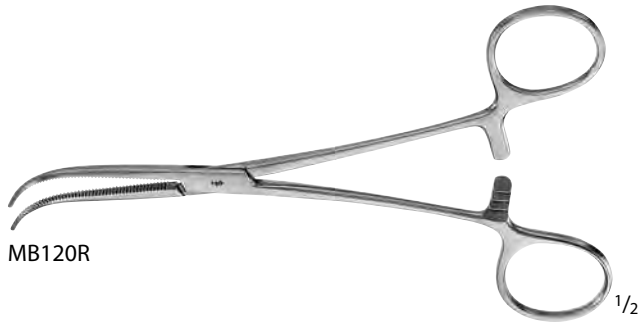

MB120R

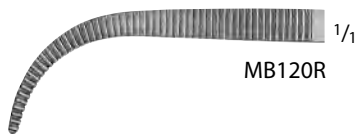

MB120R

SHALLCROSS Cystic Duct Forceps

Catalog Number	Jaw	Length (in.)
MB126R	CVD	6 7/8
US152	FULL-CVD	8



MB126R, US152



MB126R

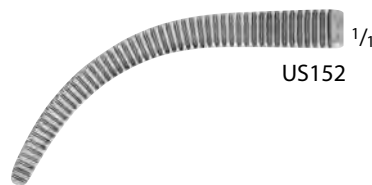

US152

BLAKE Gall Stone Forceps

Catalog Number	Jaw	Length (in.)
EB220R	STR	8
EB221R	CVD	8



EB220R-EB221R

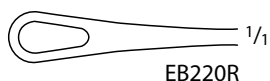

EB220R

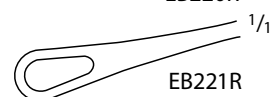

EB221R



EB231R-EB234R

DESJARDINS Gall Stone Forceps

Catalog Number	Tip	Length (in.)
EB231R	OVAL	8 7/8
EB232R	OVAL	8 7/8
EB233R	TAPERED	8 7/8
EB234R	TAPERED	8 7/8

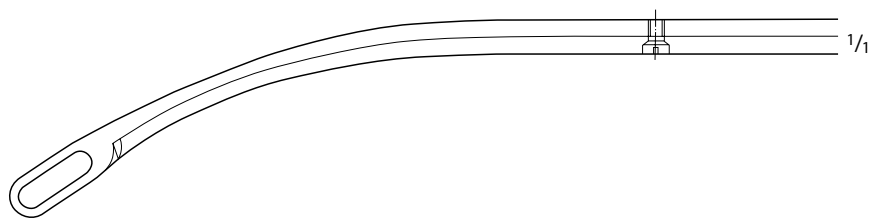

EB231R



EB232R



EB233R



EB234R

PARKER-KERR Forceps

Catalog Number	Jaw	Length (in.)
EA365R	SLIGHT-CVD	9 3/4



HEIMING Kidney Stone Forceps

Catalog Number	Jaw	Length (in.)
EF047R	SLIGHT-CVD	6 3/4
EF048R	HEAVY-CVD	6 1/4



EF051R-EF054R

RANDALL Kidney Stone Forceps

Catalog Number	Jaw	Length (in.)
EF051R	SLIGHT-CVD	8 7/8
EF052R	CVD	8 7/8
EF053R	HEAVY-CVD	8 7/8
EF054R	U-CVD	8 7/8

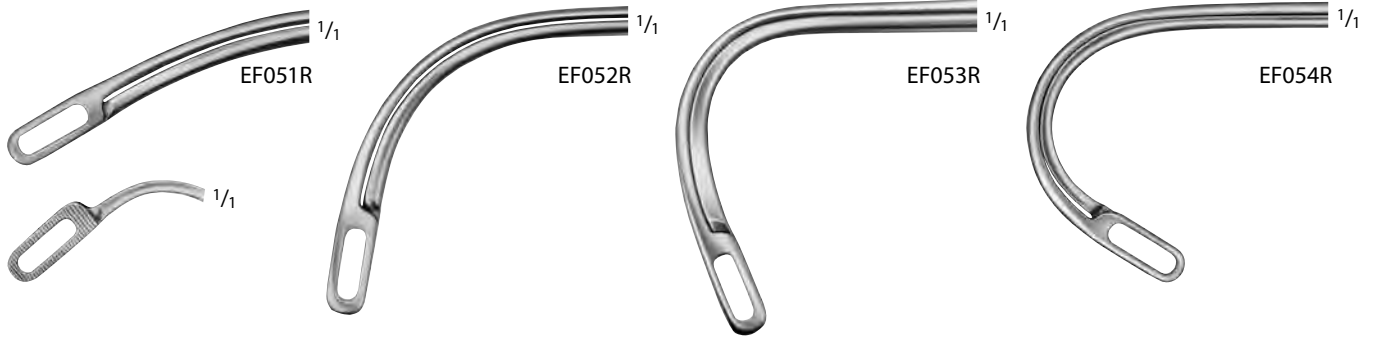

RANDALL Kidney Stone Forceps
 (continued)

Catalog Number	Jaw	Length (in.)
EF055R	CVD	7 1/2
EF056R	HEAVY-CVD	7 1/2
EB244R	90° ANG	9 5/8
EB246R	HEAVY-CVD, DEL	9

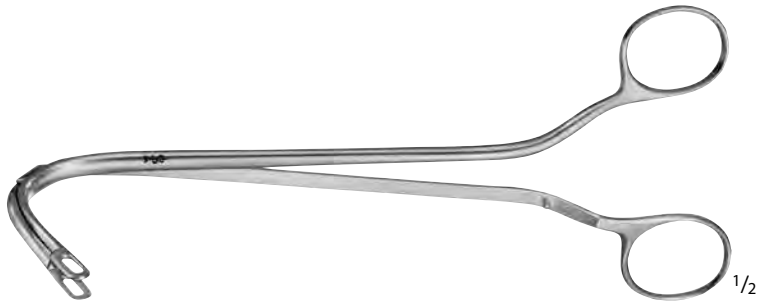

EF055R-EF056R

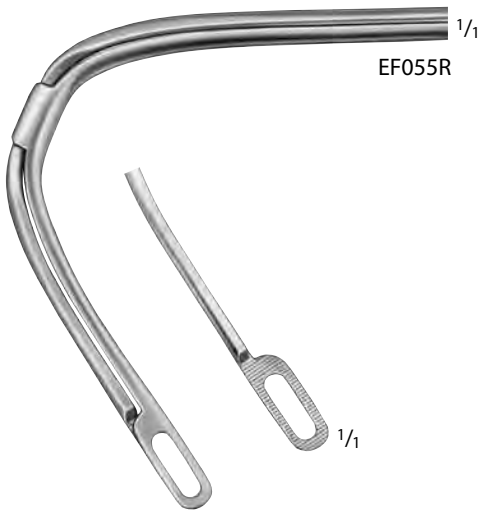

EF055R



EF056R

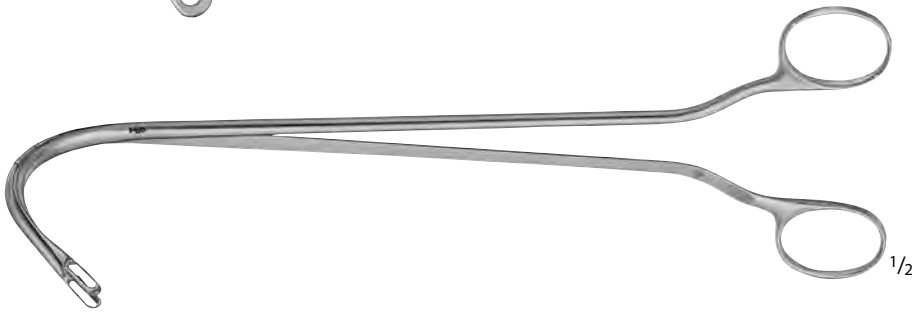

EB244R



EB244R

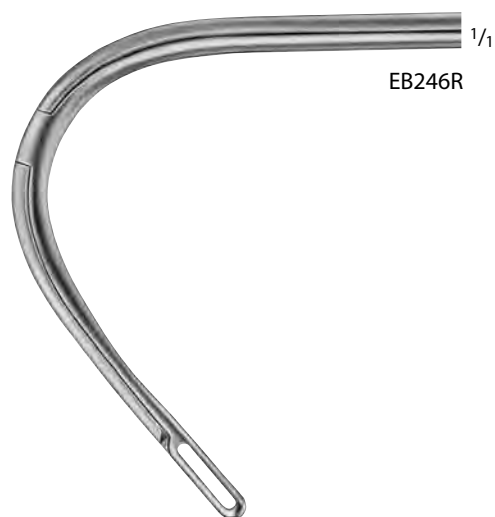

EB246R



EA202R-EA207R

KOCHER Atraumatic Forceps,
 Elastic Blades

Catalog Number	Jaw	Length (in.)
EA202R	STR	8 3/4
EA204R	STR	9 3/4
EA206R	STR	11
EA203R	CVD	8 3/4
EA205R	CVD	9 3/4
EA207R	CVD	11

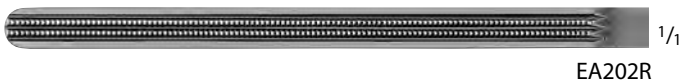

EA202R



EA204R



EA206R



EA203R



EA205R



EA207R

**HARTMANN Atraumatic Forceps,
 Elastic Blades**

Catalog Number	Jaw	Length (in.)
EA210R	STR	7 7/8
EA211R	CVD	7 7/8



EA210R-EA211R

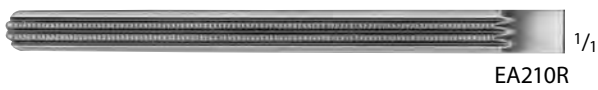

EA210R



EA211R

MAYO-ROBSON Atraumatic Forceps

Catalog Number	Jaw	Length (in.)
EA216R	STR	9 3/4
EA217R	CVD	9 3/4



EA216R-EA217R

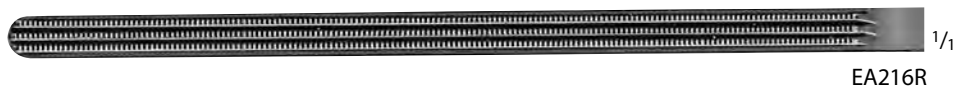

EA216R

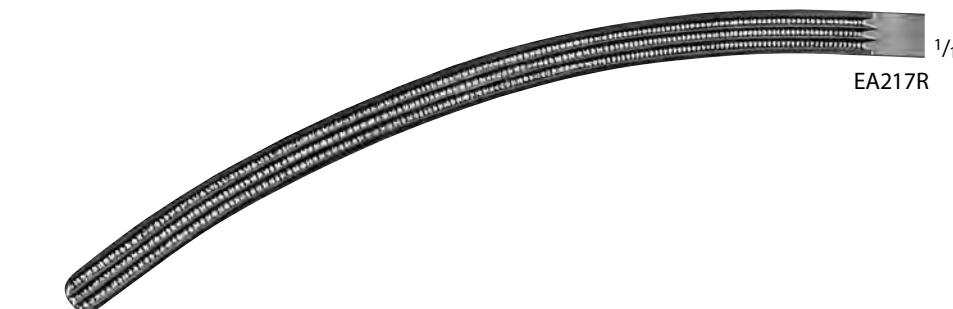

EA217R



EA212R-EA223R

DOYEN Atraumatic Forceps,
 Elastic Blades

Catalog Number	Jaw	Length (in.)
EA222R	STR	6 3/4
EA212R	STR	9
EA223R	CVD	6 3/4
EA213R	CVD	9



EA222R



EA212R



EA223R

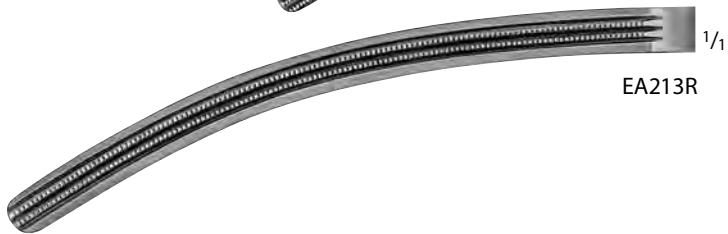

EA213R

SCUDDER Atraumatic Forceps

Catalog Number	Jaw	Length (in.)
EA240R	STR	13



EA240R



EA240R

GLASSMAN Anterior Resection Clamp

Catalog Number	Jaw	Jaw Length (mm)	Length (in.)
MB931R	90°, SERR	25	9 3/4
MB130R	90°, SERR	50	9 3/4
MB932R	90°, SERR	75	10



MB130R-MB932R

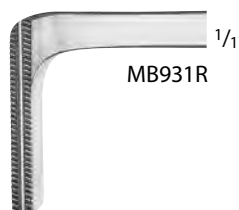

MB931R

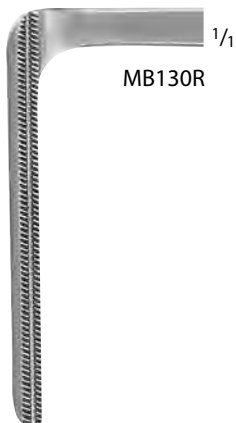

MB130R

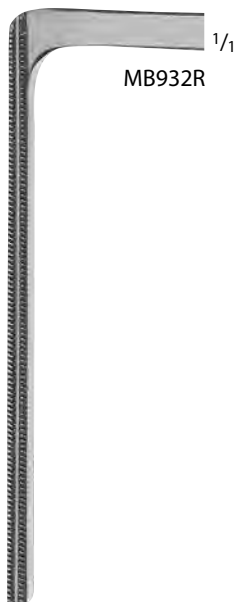

MB932R

CARTER-GLASSMAN Resection Clamp

Catalog Number	Jaw	Jaw Length (mm)	Length (in.)
MG460R	STR	110	11
MG439R	45° ANG	103	10 1/4



MG460R

1/2



1/1

MG460R



MG439R

1/2

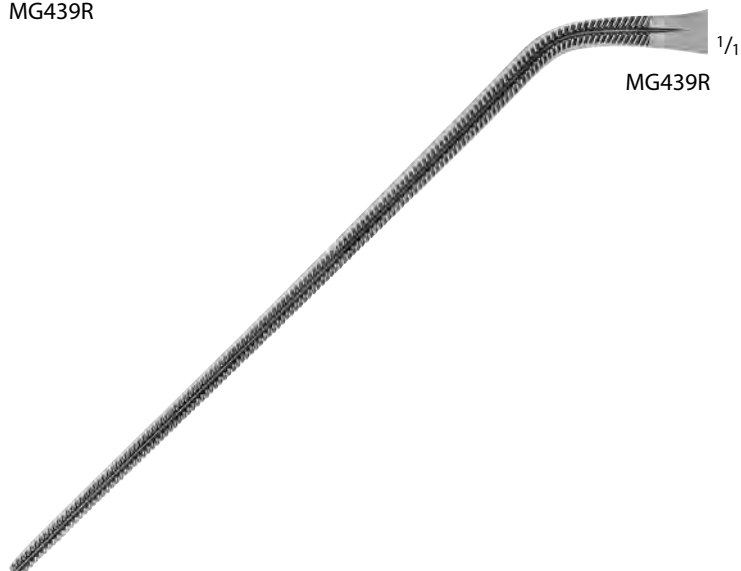

1/1

MG439R

Let Us know if you could not find what you are looking for

GLASSMAN Intestinal and Liver
 Holding Clamp, Non-Crushing

Catalog Number	Jaw	Length (in.)
MG436R	STR	9 3/4
MG437R	CVD	9 5/8
MG438R	FULL CVD	9



MG436R-MG438R



1/1
 MG436R



1/1
 MG437R



1/1
 MG438R

GLASSMAN Gastroenterostomy Clamp

Catalog Number	Jaw	Jaw Length (mm)	Length (in.)
MG433R	STR	116	11 1/2
MG434R	ANG	115	11 1/2



MG433R-MG434R



MG433R



MG434R



MB138R-MB139R

GLASSMAN Gastrointestinal Clamp,
 Non-Crushing

Catalog Number	Jaw	Length (in.)
MB138R	STR	9 1/4
MB139R	ANG	9



MB138R



MB139R

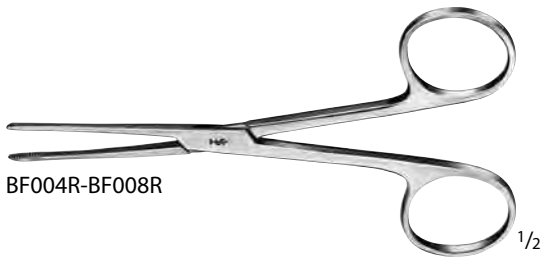

BF004R-BF008R

LISTER Sponge Forceps

Catalog Number	Jaw	Length (in.)
BF004R	STR	5 1/4
BF006R	STR	6 1/4
BF008R	STR	7 1/4



BF004R

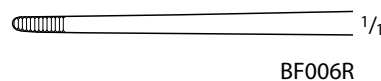

BF006R

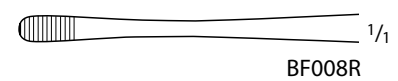

BF008R



BF046R-BF047R

GROSS Forceps, W/ Ratchet

Catalog Number	Jaw	Length (in.)
BF046R	STR	7 7/8
BF047R	CVD	7 7/8



BF046R

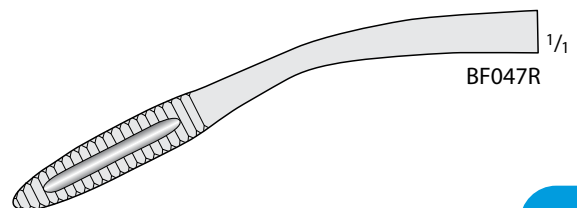

BF047R



BF078R

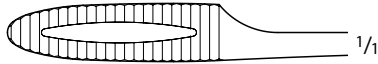

BF078R

SIMS-MAIER Sponge Forceps

Catalog Number	Jaw	Length (in.)
BF078R	STR	13 3/4

Sponge Forceps

Catalog Number	Jaw	Length (in.)
BF062R	STR	10 1/2
BF063R	CVD	10 1/2
BF065R	CVD	13 3/4



BF062R-BF063R



BF062R



BF063R



BF065R

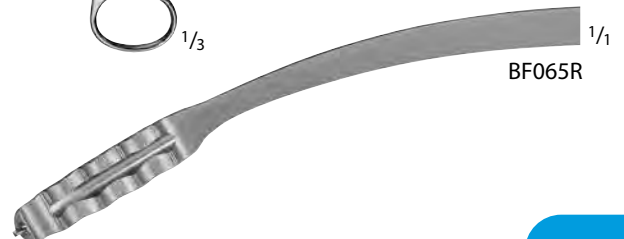

BF065R

RAMPLEY Sponge Forceps

Catalog Number	Tip	Jaw	Length (in.)
BF116R	SERR	STR	7
BF118R	SERR	STR	9 3/4



BF116R-BF118R

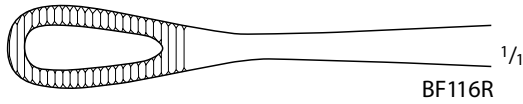

BF116R

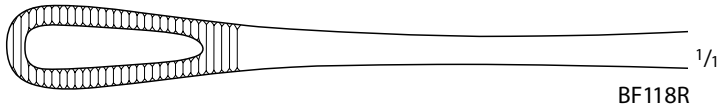

BF118R

FOERSTER Sponge Forceps

Catalog Number	Tip	Jaw	Length (in.)
MB098R	SERR	STR	12
MB099R	SERR	STR	14
MB904R	SERR	STR	16



MB098R-MB904R



MB098R



MB099R



MB904R



BF112R-BF113R



BF120R-BF123R

FOERSTER-BALLENGER Sponge Forceps

Catalog Number	Tip	Jaw	Length (in.)
BF112R	SERR	STR	7
BF120R	SMOOTH	STR	9 5/8
BF122R	SERR	STR	9 5/8
BF113R	SERR	CVD	7
BF121R	SMOOTH	CVD	9 5/8
BF123R	SERR	CVD	9 5/8

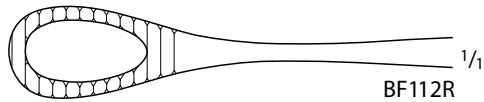

BF112R

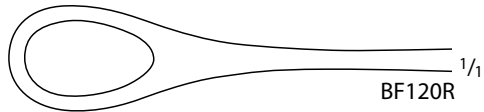

BF120R

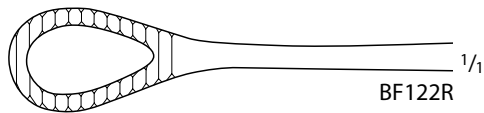

BF122R

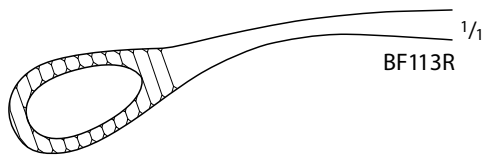

BF113R



BF121R

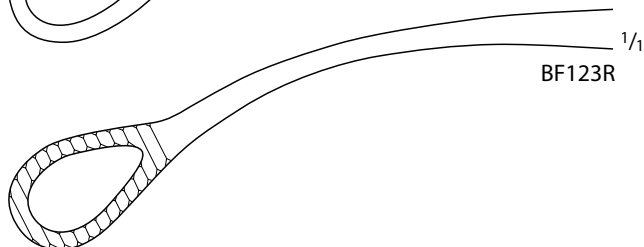

BF123R

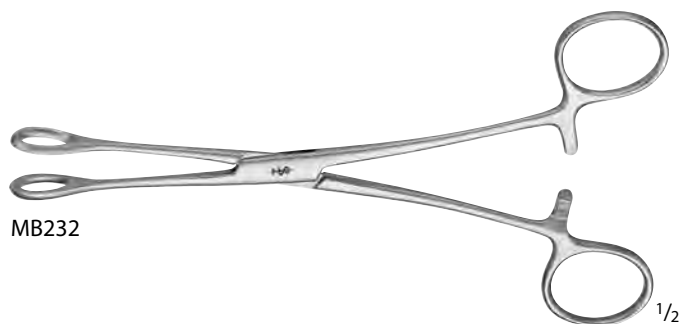

MB232

BALLENGER Sponge Forceps

Catalog Number	Tip	Jaw	Length (in.)
MB232	SMOOTH	STR	7



MB232

KELLY Sponge Forceps

Catalog Number	Tip	Jaw	Handle	Length (in.)
BF135R	SERR	CVD	W/ OUT RATCHET	12 1/2
BF136R	SERR	CVD	W/ RATCHET	12 1/2



BF135R



BF136R

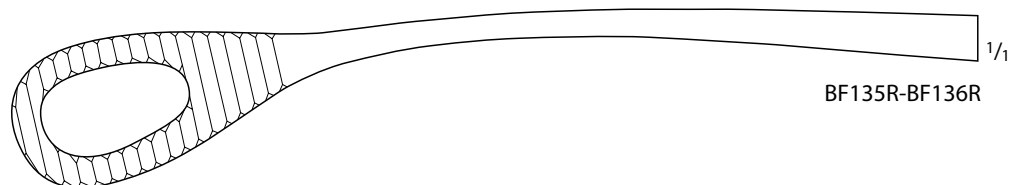

BF135R-BF136R

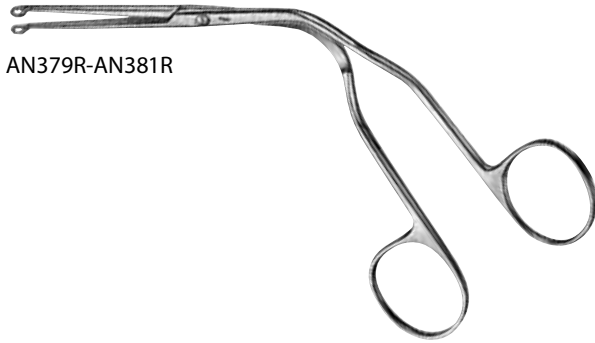

AN379R-AN381R

MAGILL Forceps

Catalog Number	Size	Length (in.)
AN379R	INFANT	6
AN380R	PEDIATRIC	7 7/8
AN381R	ADULT	9 3/4



AN379R



AN380R



AN381R



BH906R-BH908R

COLLIN Forceps W/ Ratchet

Catalog Number	Jaw	Length (in.)
BH906R	OVAL	6 1/4
BH908R	TEARDROP	6 1/4

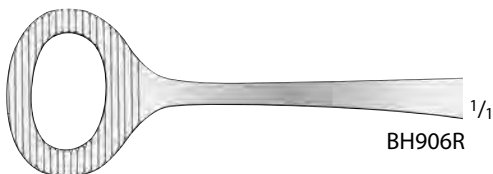

BH906R

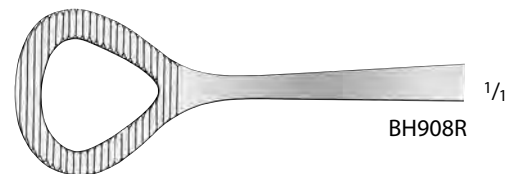

BH908R

HEYWOOD-SMITH Forceps

Catalog Number	Tip	Length (in.)
AN710R	SERR	7 7/8
AN711R	SERR	8 1/4



AN710R

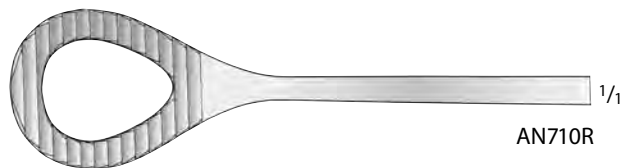

AN710R

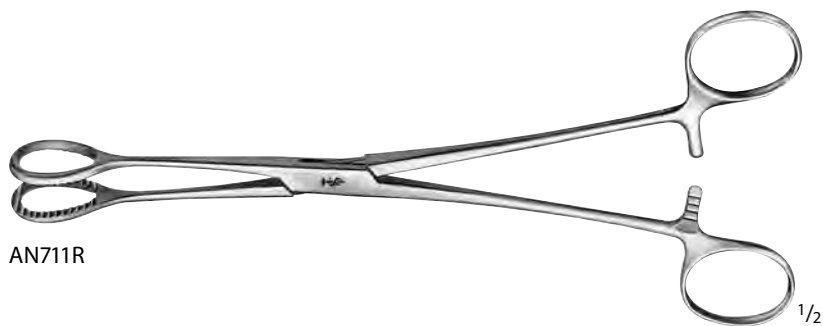

AN711R

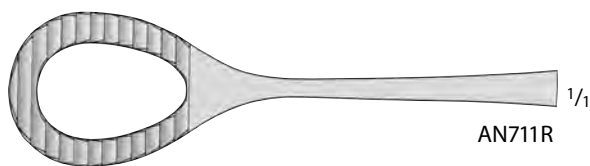

AN711R

YEOMAN Rectal Biopsy Forceps

Catalog Number	Tip Size (mm)	Shaft Length (in.)
EA903R	4	16 1/2

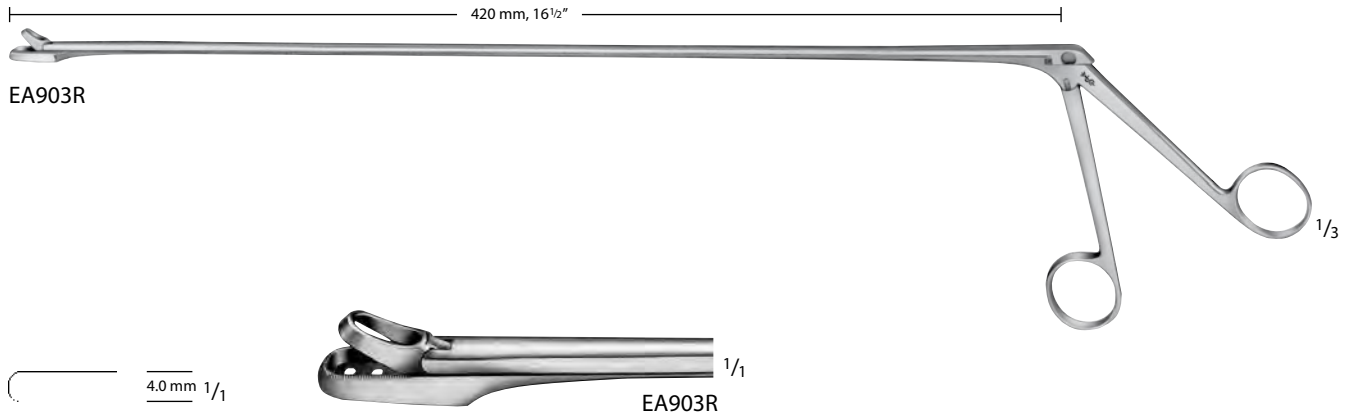

Rectal Swab Holder

Catalog Number	Shaft Length (in.)
EA943R	15 3/4

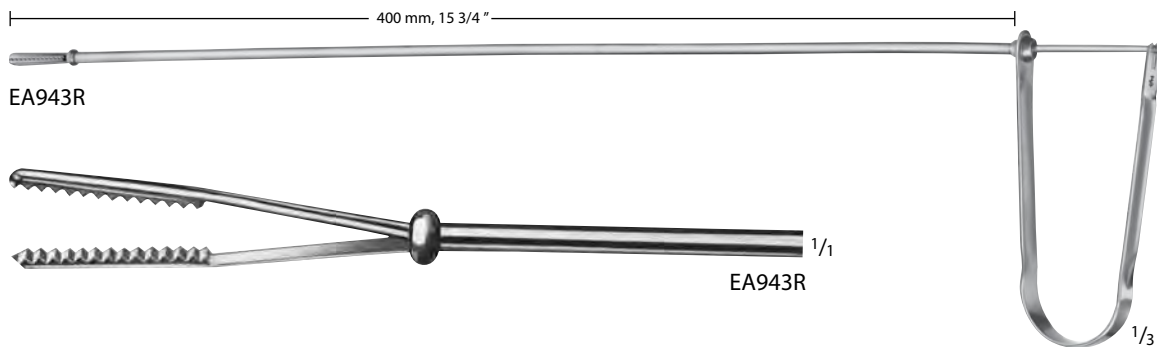

PRICE Muscle Biopsy Clamp

Catalog Number	Jaw	Jaw Size (mm)	Length (in.)
MB200R	DOUBLE-PRONG	8	4
MG098R	DOUBLE-PRONG	15	4 3/8





BH332R-BH339R



BH332R

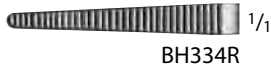

BH334R



BH336R



BH338R

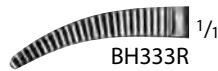

BH333R

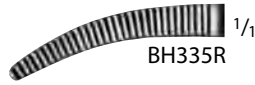

BH335R



BH337R



BH339R

SPENCER-WELLS Forceps

Catalog Number	Jaw	Length (in.)
BH332R	STR	5 1/8
BH334R	STR	6
BH336R	STR	6 7/8
BH338R	STR	7 7/8
BH333R	CVD	5 1/8
BH335R	CVD	6
BH337R	CVD	6 7/8
BH339R	CVD	7 7/8



BH412R-BH415R



BH412R



BH414R



BH413R



BH415R

PEAN Forceps, Delicate

Catalog Number	Jaw	Length (in.)
BH412R	STR	5 1/8
BH414R	STR	5 1/2
BH413R	CVD	5 1/8
BH415R	CVD	5 1/2

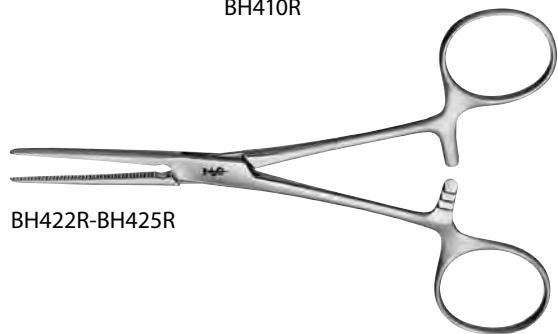

PEAN Forceps

Catalog Number	Jaw	Length (in.)
BH410R	STR	5
BH422R	STR	5 1/8
BH424R	STR	5 1/2
BH425R	CVD	5 1/2

PEAN Artery Forceps

Catalog Number	Jaw	Length (in.)
MB180R	CVD	12
MB181R	CVD	14

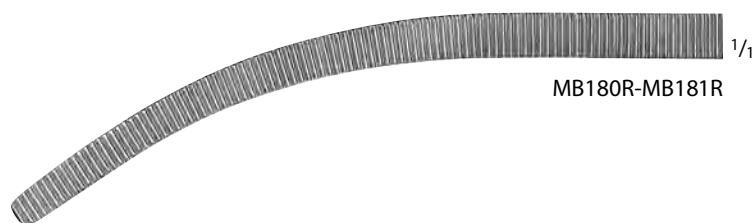

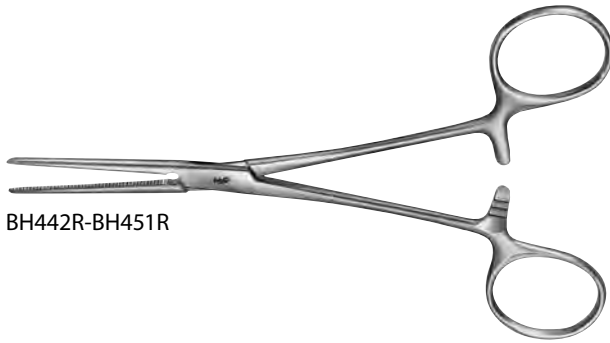

BH442R-BH451R

ROCHESTER-PEAN Forceps

Catalog Number	Jaw	Length (in.)
BH442R	STR	6 1/4
BH444R	STR	7 1/4
BH446R	STR	7 7/8
BH448R	STR	8 7/8
BH450R	STR	9 1/2
BH443R	CVD	6 1/4
BH445R	CVD	7 1/4
BH447R	CVD	7 7/8
BH449R	CVD	8 7/8
BH451R	CVD	9 1/2



BH442R



BH444R



BH446R



BH448R



BH450R



BH443R



BH445R



BH447R



BH449R

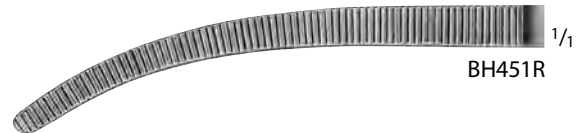

BH451R

Let Us know if you could not find what you are looking for



BH470R-BH475R, MB128R

PEAN Forceps, Long

Catalog Number	Jaw	Length (in.)
BH470R	STR	9 1/2
BH472R	STR	10 1/4
BH474R	STR	11
MB128R	STR	12
BH471R	CVD	9 1/2
BH473R	CVD	10 1/4
BH475R	CVD	11



BH470R



BH472R



BH474R



MB128R

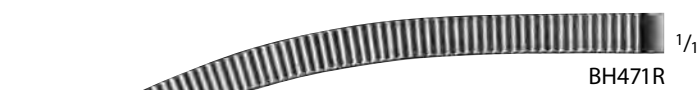

BH471R

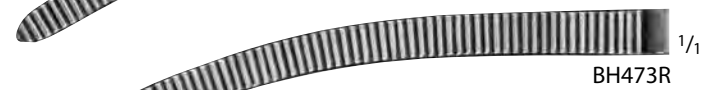

BH473R

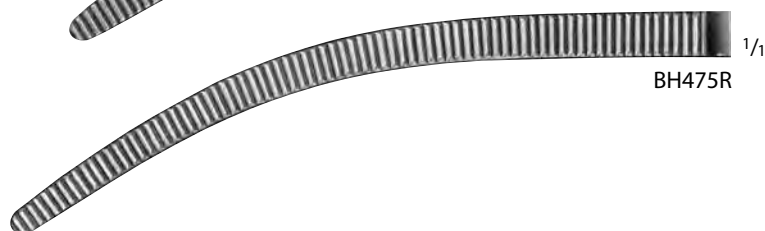

BH475R

KOCHER Forceps, Delicate

Catalog Number	Jaw	Teeth	Length (in.)
BH614R	STR	1 x 2	5 1/2
BH615R	CVD	1 x 2	5 1/2



BH614R-BH615R



BH614R



BH615R

KOCHER Forceps

Catalog Number	Jaw	Teeth	Length (in.)
BH630R	STR	1 x 2	6
BH631R	CVD	1 x 2	6



BH630R-BH631R



BH630R



BH631R

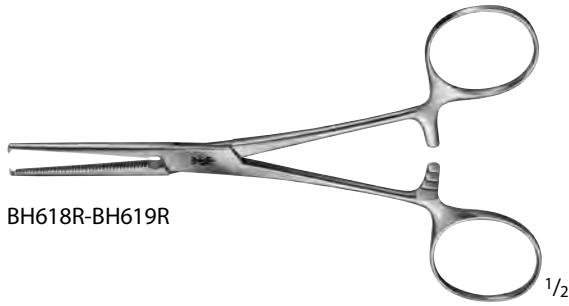

BH618R-BH619R



BH618R



BH619R

ROCHESTER-OCHSNER Forceps

Catalog Number	Jaw	Teeth	Length (in.)
BH618R	STR	1 x 2	5 1/2
BH619R	CVD	1 x 2	5 1/2

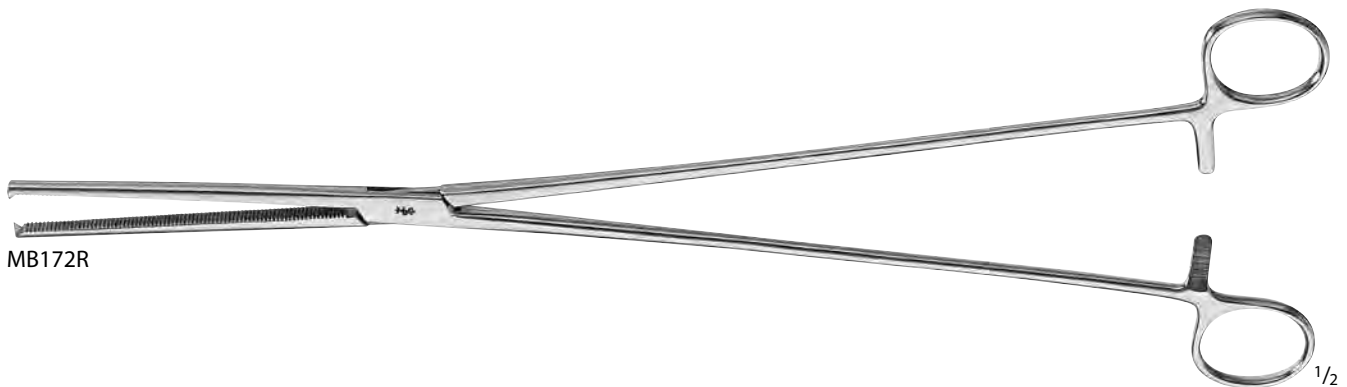

MB172R



MB172R

ROCHESTER-OCHSNER Artery Forceps

Catalog Number	Jaw	Teeth	Length (in.)
MB172R	STR	1 x 2	14

Let Us know if you could not find what you are looking for



BH642R-BH655R

KOCHER-OCHSNER Forceps

Catalog Number	Jaw	Teeth	Length (in.)
BH642R	STR	1 x 2	6 1/4
BH644R	STR	1 x 2	7 1/4
BH646R	STR	1 x 2	7 7/8
BH648R	STR	1 x 2	8 7/8
BH650R	STR	1 x 2	9 1/2
BH652R	STR	1 x 2	10 1/4
BH654R	STR	1 x 2	11
BH643R	CVD	1 x 2	6 1/4
BH645R	CVD	1 x 2	7 1/4
BH647R	CVD	1 x 2	7 7/8
BH649R	CVD	1 x 2	8 7/8
BH651R	CVD	1 x 2	9 1/2
BH653R	CVD	1 x 2	10 1/4
BH655R	CVD	1 x 2	11



BH642R



BH644R



BH646R



BH648R



BH650R



BH652R



BH654R



BH643R



BH645R



BH647R



BH649R

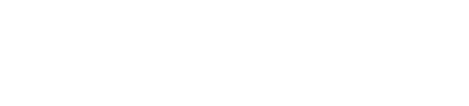

BH651R



BH653R

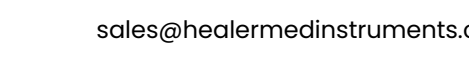

BH655R

Let Us know if you could not find what you are looking for

ROCHESTER-OCHSNER Forceps

Catalog Number	Jaw	Teeth	Length (in.)
MB807R	STR	1 x 2	14
MB909R	STR	1 x 2	16
MB908R	CVD	1 x 2	13 3/4

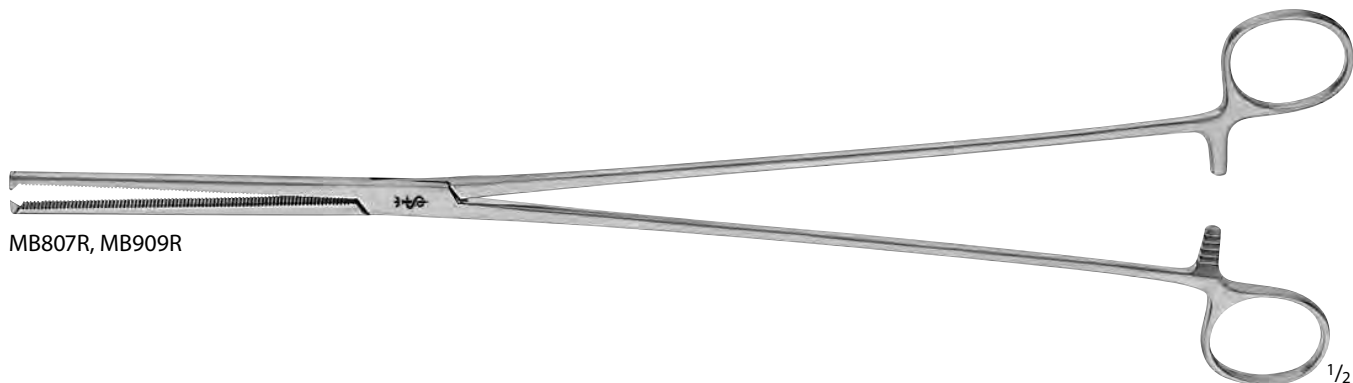

MB807R, MB909R



MB807R



MB908R



MB908R

Let Us know if you could not find what you are looking for



BH800R, MG432R

ROCHESTER-CARMALT Forceps

Catalog Number	Jaw	Length (in.)
BH800R	STR	6 1/4
BH804R	STR	7 7/8
MG196R	STR	9
MG431R	STR	10 1/4
BH801R	CVD	6 1/4
BH805R	CVD	7 7/8
MG197R	CVD	9
MG432R	CVD	10 1/4



BH800R 1/1



BH801R 1/1



BH804R 1/1



BH805R 1/1



MG196R 1/1



MG197R 1/1



MG431R 1/1



MG432R 1/1

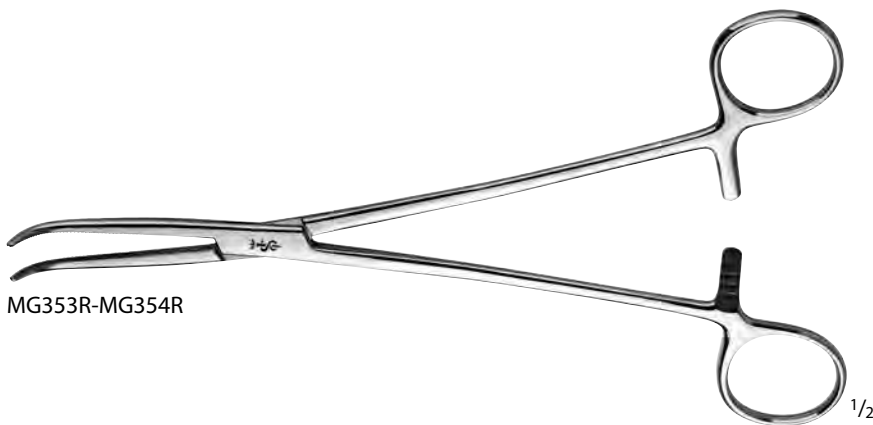

MG353R-MG354R

STOREY Forceps

Catalog Number	Tip	Length (in.)
MG353R	STRONG-CVD	8 3/4
MG354R	RIGHT-ANG	8 3/4



MG353R 1/1



MG354R 1/1



JONES Hemostatic Forceps

Catalog Number	Jaw	Length (in.)
MG426R	STR	5

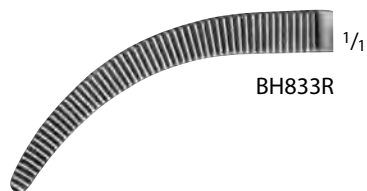
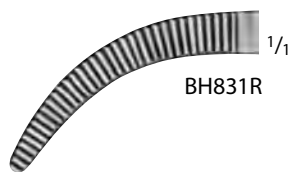
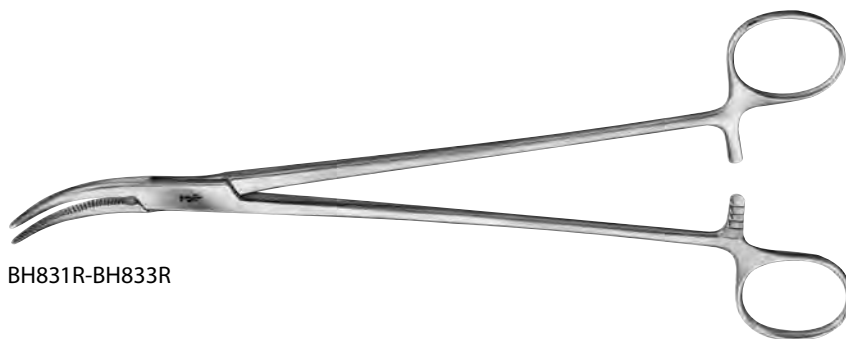

MOYNIHAN Forceps

Catalog Number	Jaw	Length (in.)
BH831R	CVD	9
BH833R	CVD	9 1/2

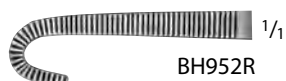
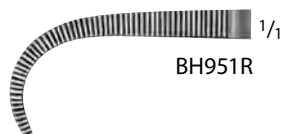
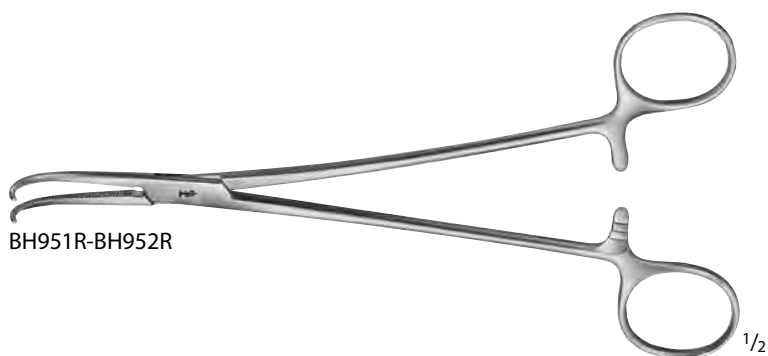

NEGUS Tonsil Forceps

Catalog Number	Jaw	Length (in.)
BH951R	HEAVY-CVD	7 1/2
BH952R	U-CVD	7 1/2

CARMALT Artery Forceps, Longitudinal
 Serrations

Catalog Number	Jaw	Length (in.)
MB182R	SLIGHT-CVD	12

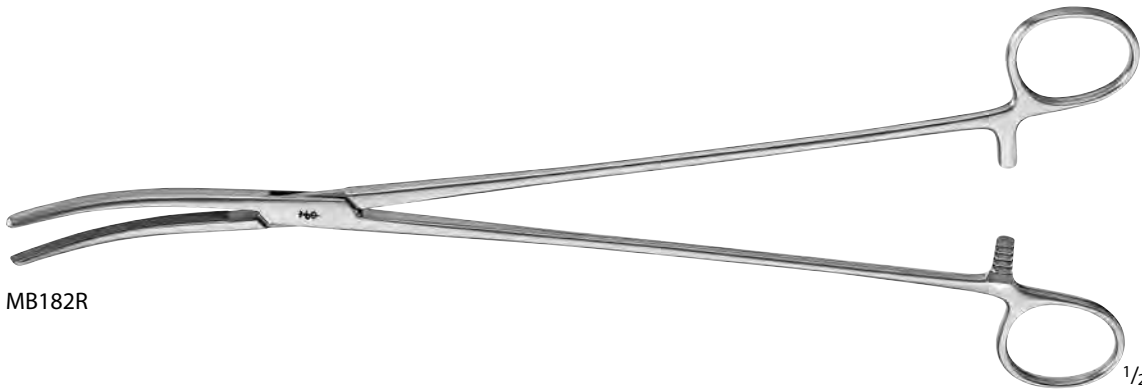

MB182R



MB182R

SCHNIDT Tonsil Clamp

Catalog Number	Ring Handle	Jaw	Length (in.)
MA172R	OPEN RING	STR	7 1/2
BH961R	OPEN-RING	SLIGHT-CVD	7 1/4
BH963R	OPEN-RING	CVD	7 1/4
BH957R	CLOSED-RING	SLIGHT-CVD	7 1/4
BH959R	CLOSED-RING	CVD	7 1/4

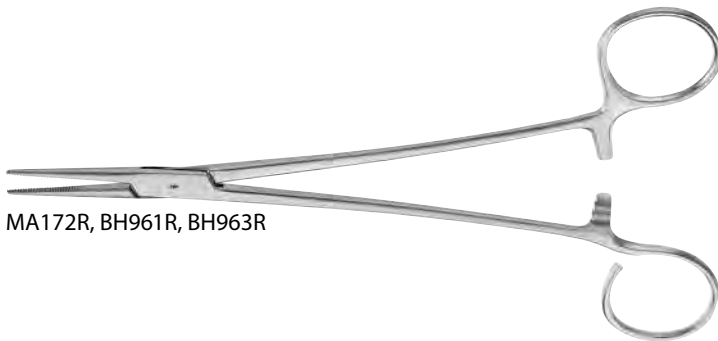

MA172R, BH961R, BH963R



MA172R



BH961R



BH963R

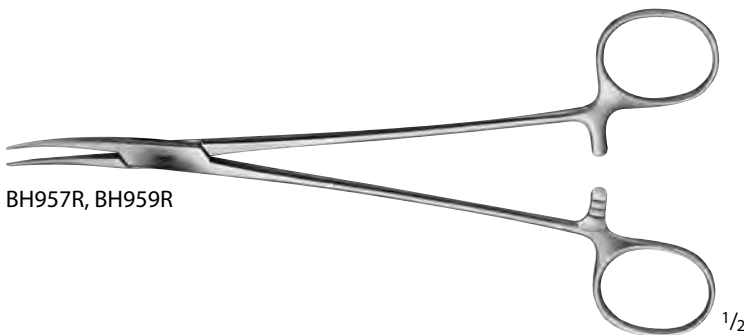

BH957R, BH959R



BH957R



BH959R



MD450

1/2



MD450

OCHSNER-DIXON Artery Forceps

Catalog Number	Jaw	Teeth	Length (in.)
MD450	STR	1 x 2	6 1/4



BH104R-BH115R

1/2



BH104R



BH105R



BH114R



BH115R

Baby HARTMANN Mosquito Artery
 Forceps

Catalog Number	Jaw	Teeth	Length (in.)
BH104R	STR	-	4
BH114R	STR	1 x 2	4
BH105R	CVD	-	4
BH115R	CVD	1 x 2	4

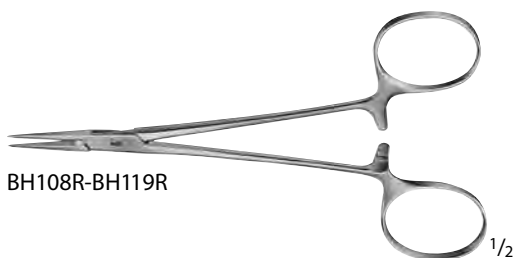

BH108R-BH119R

1/2



BH108R



BH109R



BH118R



BH119R

Micro HALSTED Mosquito Forceps,
 Delicate

Catalog Number	Jaw	Teeth	Length (in.)
BH108R	STR	-	5
BH118R	STR	1 x 2	5
BH109R	CVD	-	5
BH119R	CVD	1 x 2	5

HALSTED Mosquito Forceps, Delicate

Catalog Number	Jaw	Teeth	Length (in.)
BH110R	STR	-	5
BH120R	STR	1 x 2	5
BH210R	STR	-	7 7/8
BH214R	STR	1 x 2	7 7/8
BH111R	CVD	-	5
BH121R	CVD	1 x 2	5
BH211R	CVD	-	7 7/8
BH215R	CVD	1 x 2	7 7/8



BH110R-BH121R



BH110R



BH111R



BH120R



BH121R

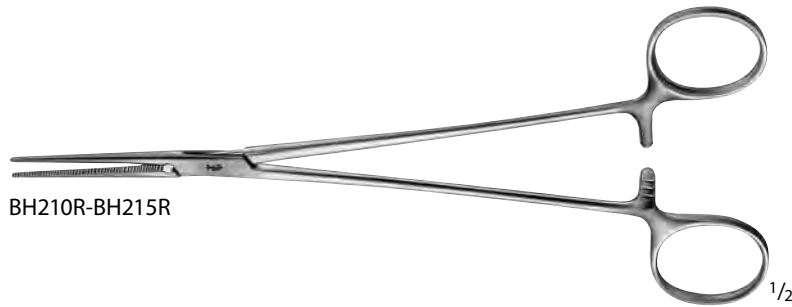

BH210R-BH215R



BH210R



BH211R



BH214R



BH215R



BH106R



BH106R

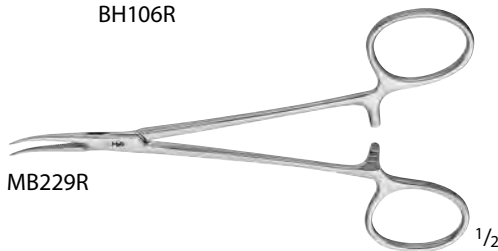

MB229R



MB229R

JACOBSON Mosquito Forceps

Catalog Number	Jaw	Length (in.)
BH106R	STR	5 1/8
MB229R	CVD	5

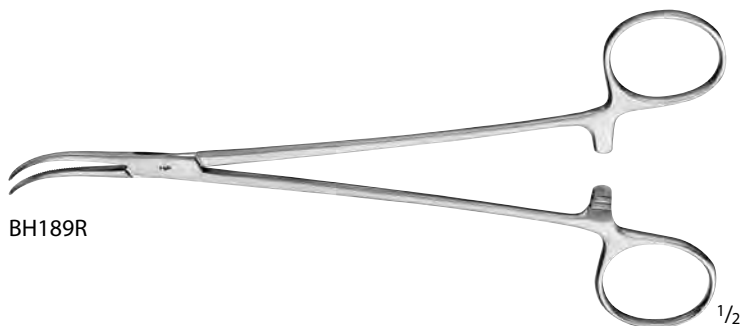
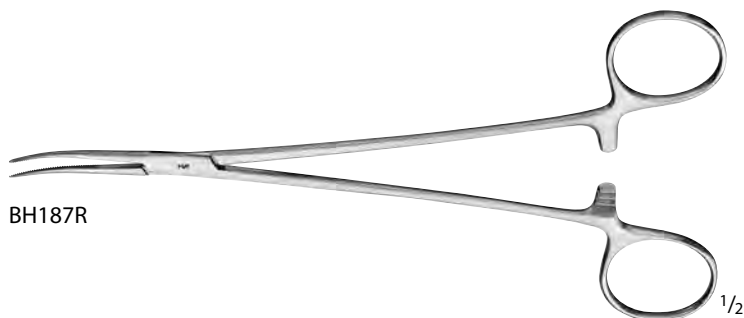
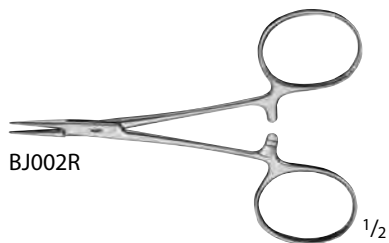

Mosquito Forceps

Catalog Number	Jaw	Length (in.)
MG085R	DEL, CVD.	6

Suture Forceps

Catalog Number	Tip	Jaw	Length (in.)
BJ002R	SMOOTH	STR	3 3/4

JACOBSON Hemostatic Forceps

Catalog Number	Jaw	Length (in.)
BH187R	SLIGHT-CVD	7 1/2
BH189R	HEAVY-CVD	7 1/2

ADSON Hemostatic Forceps

Catalog Number	Jaw	Length (in.)
BH205R	CVD	8 1/2

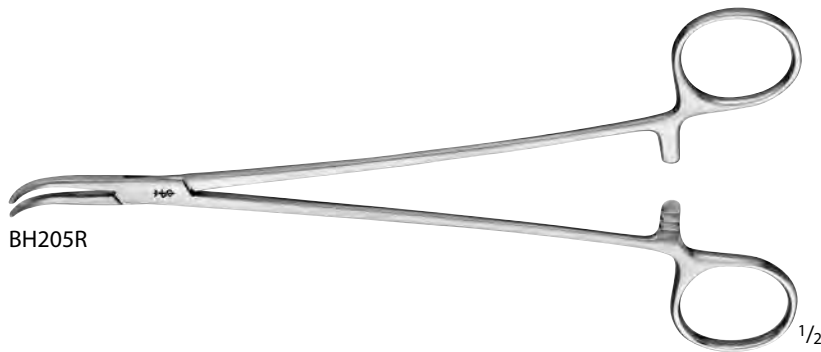

BH205R

1/2



BH205R

1/1

HALSTED Forceps Delicate

Catalog Number	Jaw	Teeth	Length (in.)
BH202R	STR	-	7 1/4
BH212R	STR	1 x 2	7 1/4
BH203R	CVD	-	7 1/4
BH213R	CVD	1 x 2	7 1/4

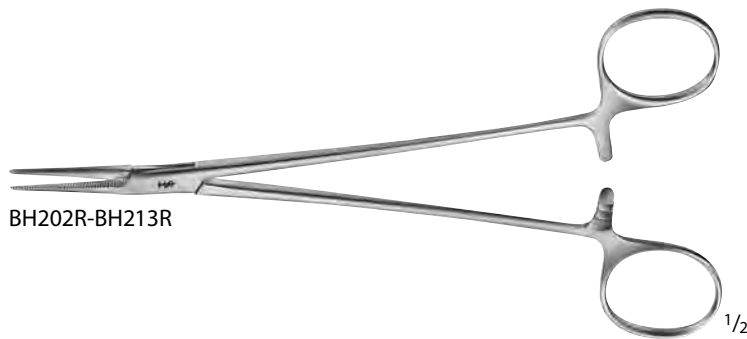

BH202R-BH213R

1/2

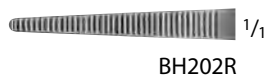

BH202R

1/1

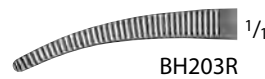

BH203R

1/1



BH212R

1/1



BH213R

1/1

PROVIDENCE Hospital Forceps,
 Delicate

Catalog Number	Jaw	Length (in.)
BH130R	STR	5 1/2
BH131R	CVD	5 1/2

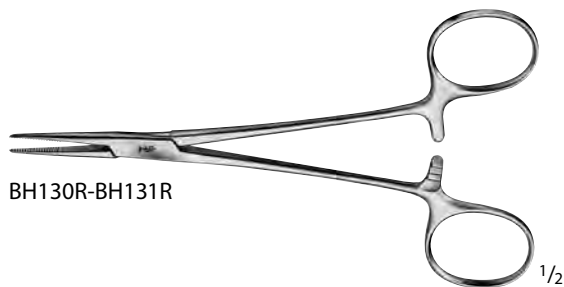

BH130R-BH131R

1/2



BH130R

1/1



BH131R

1/1



BH134R-BH135R



BH134R



BH135R

KELLY Forceps

Catalog Number	Jaw	Length (in.)
BH134R	STR	5 1/2
BH135R	CVD	5 1/2

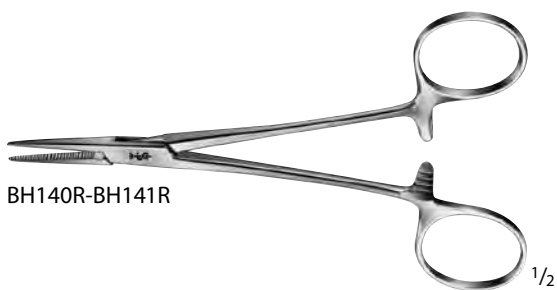

BH140R-BH141R



BH140R



BH141R

Baby CRILE Forceps

Catalog Number	Jaw	Teeth	Length (in.)
BH140R	STR	-	5 1/2
BH150R	STR	1 x 2	5 1/2
BH141R	CVD	-	5 1/2
BH151R	CVD	1 x 2	5 1/2

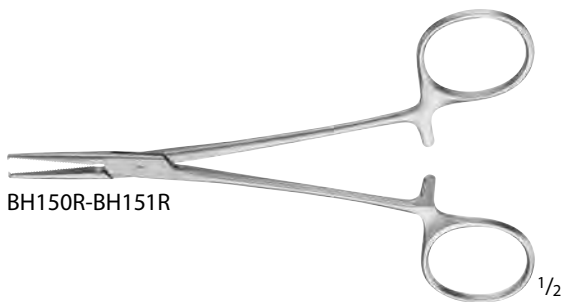

BH150R-BH151R



BH150R



BH151R

CRILE Forceps

Catalog Number	Jaw	Teeth	Length (in.)
BH144R	STR	-	5 1/2
BH154R	STR	1 x 2	5 1/2
BH166R	STR	-	6 1/4
BH176R	STR	1 x 2	6 1/4
BH145R	CVD	-	5 1/2
BH155R	CVD	1 x 2	5 1/2
BH167R	CVD	-	6 1/4
BH177R	CVD	1 x 2	6 1/4



BH144R-BH155R



BH144R

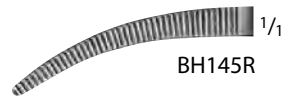

BH145R



BH154R



BH155R



BH166R-BH177R



BH166R



BH167R



BH176R



BH177R

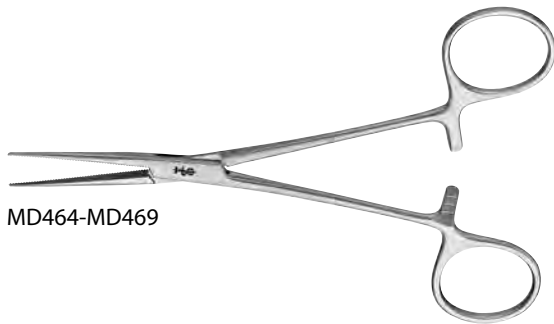

MD464-MD469



MD464



MD466R



MD468

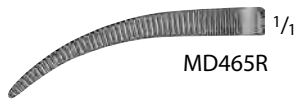

MD465R



MD467R



MD469

COLLER Artery Forceps

Catalog Number	Jaw	Length (in.)
MD464	STR	5 3/4
MD466R	STR	6 1/2
MD468	STR	7
MD465R	CVD	5 3/4
MD467R	CVD	6 1/2
MD469	CVD	7

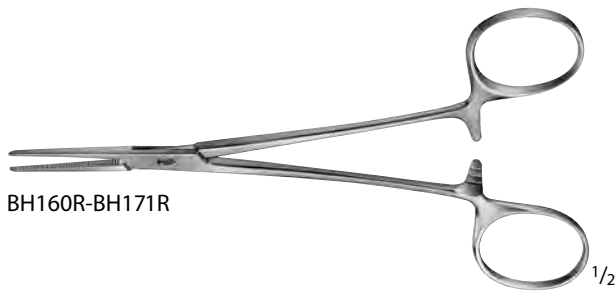

BH160R-BH171R



BH160R



BH170R

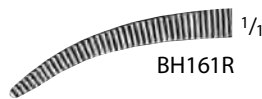

BH161R



BH171R

LERICHE Forceps, Delicate

Catalog Number	Jaw	Teeth	Length (in.)
BH160R	STR	-	6
BH170R	STR	1 x 2	6
BH161R	CVD	-	6
BH171R	CVD	1 x 2	6

RANKIN Forceps, Delicate

Catalog Number	Jaw	Length (in.)
BH164R	STR	6 1/4
BH165R	CVD	6 1/4



BH164R-BH165R

1/2



BH164R

1/1



BH165R

1/1

BIRKETT Hemostatic Forceps

Catalog Number	Jaw	Length (in.)
BH197R	CVD	7 1/4

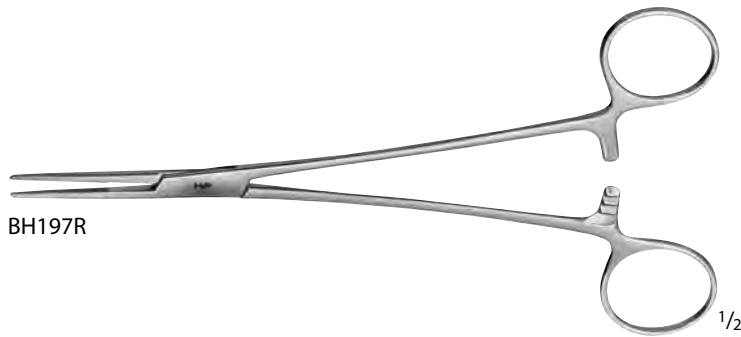

BH197R

1/2



BH197R

1/1

NISSEN Tonsil Forceps, Delicate

Catalog Number	Jaw	Length (in.)
BH199R	CVD	7 1/4

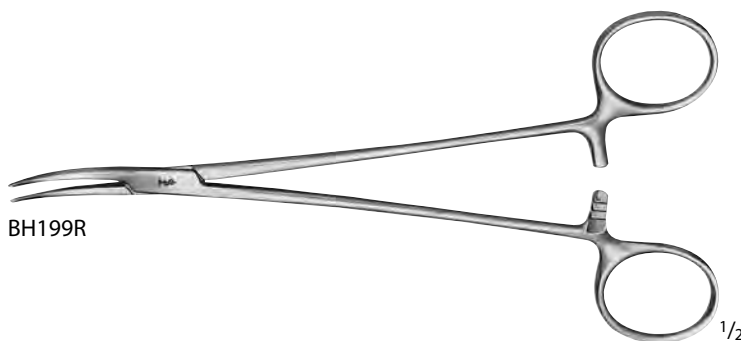

BH199R

1/2

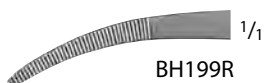

BH199R

1/1

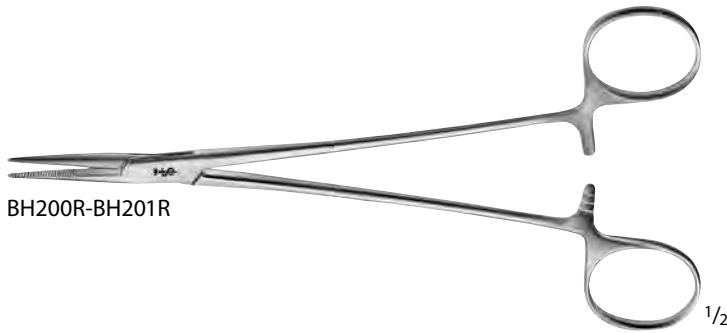

BH200R-BH201R



BH200R



BH201R

ADSON Tonsil Forceps, Delicate

Catalog Number	Jaw	Length (in.)
BH200R	STR	7 1/4
BH201R	CVD	7 1/4



BH206R-BH217R



BH206R



BH216R



BH207R



BH217R



BH209R

HEISS Forceps, Delicate

Catalog Number	Jaw	Teeth	Length (in.)
BH206R	STR	-	7 7/8
BH216R	STR	1 x 2	7 7/8
BH207R	CVD	-	7 7/8
BH217R	CVD	1 x 2	7 7/8
BH209R	HVY-CVD	-	7 3/4

BENGOLEA Forceps, Delicate

Catalog Number	Jaw	Length (in.)
BH228R	STR	9 5/8
BH229R	CVD	9 5/8

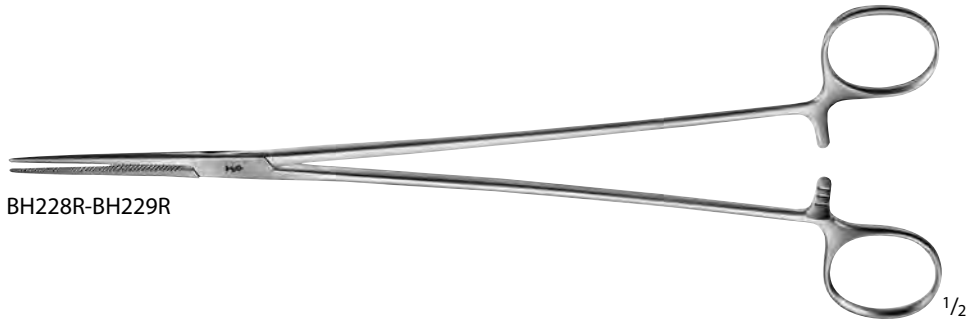

BH228R-BH229R



BH228R



BH229R

BRIDGE Forceps, Delicate

Catalog Number	Jaw	Length (in.)
BH230R	STR	10 3/4
BH231R	CVD	10 3/4

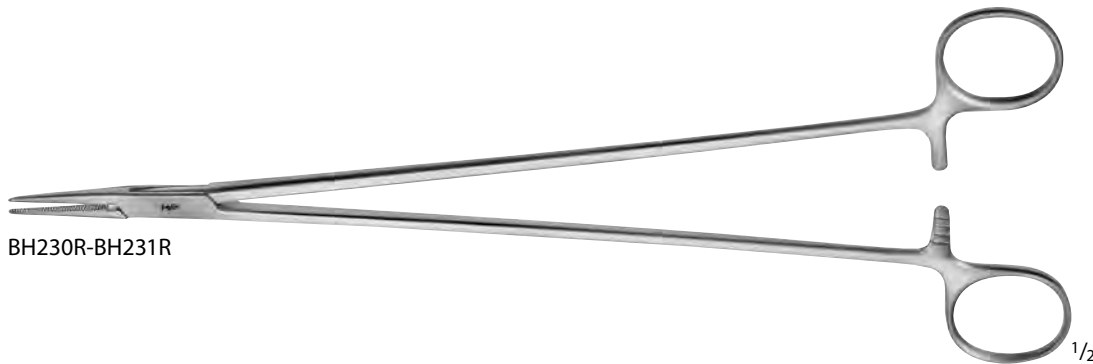

BH230R-BH231R



BH230R

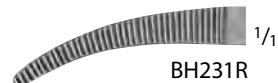

BH231R

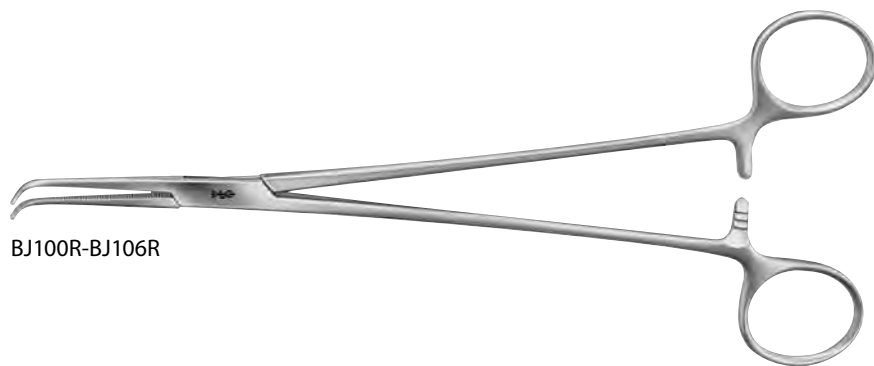

BJ100R-BJ106R

GEMINI Right Angle Forceps

Catalog Number	Length (in.)
BJ100R	5 1/2
BJ102R	7
BJ103R	7 7/8
BJ104R	9
BJ106R	11

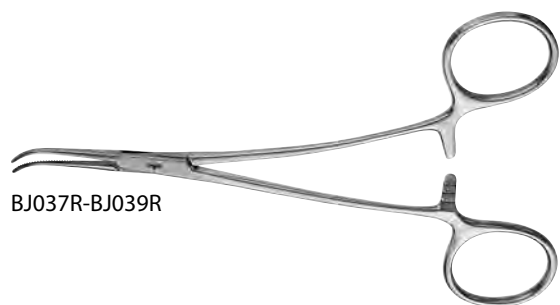
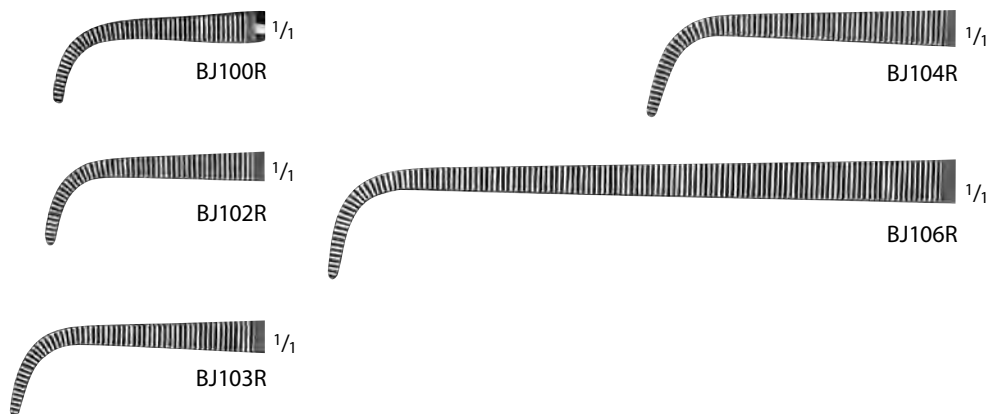

BJ037R-BJ039R

HOLLE Forceps, Delicate

Catalog Number	Length (in.)
BJ037R	5 3/4
BJ038R	7 1/4
BJ039R	9 1/4



KANTROWITZ Right Angle Forceps

Catalog Number	Length (in.)
MB058R	6 3/8
BJ057R	7 7/8
BJ058R	9 5/8
BJ059R	10 3/4
MB061R	12

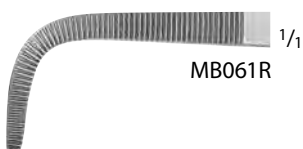
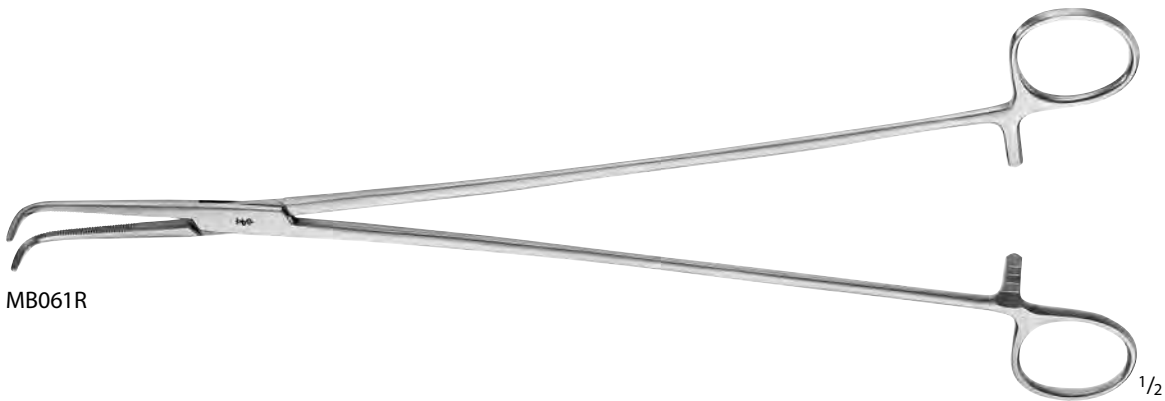
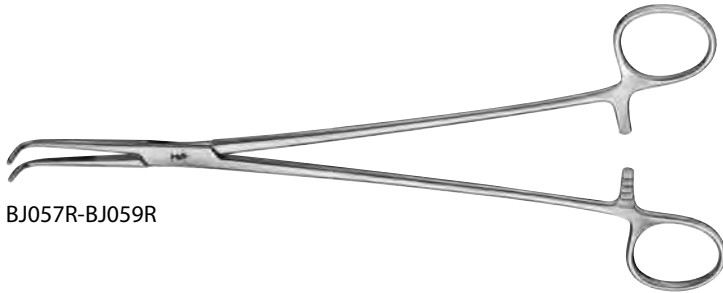

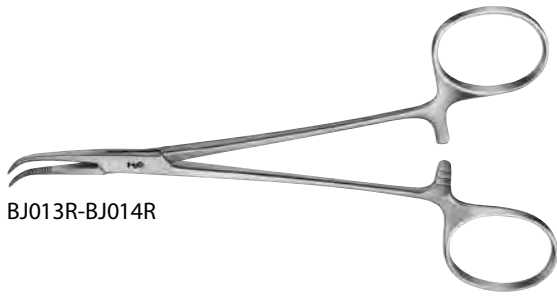

BJ013R-BJ014R



BJ013R



BJ014R

Baby ADSON Forceps

Catalog Number	Length (in.)
BJ013R	5 1/2
BJ014R	7



BJ008R



BJ008R

Micro ADSON Suture Forceps

Catalog Number	Length (in.)
BJ008R	5 1/2

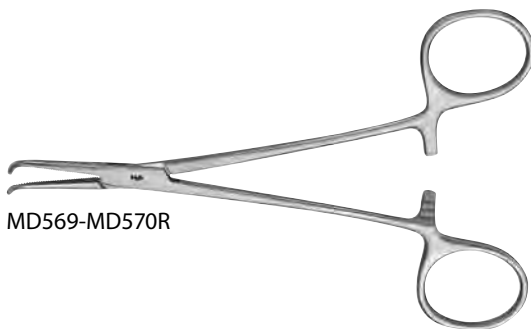

MD569-MD570R



MD569



MD570R

MIXTER (MEEKER) Right Angle Forceps

Catalog Number	Length (in.)
MD569	5 1/2
MD570R	7



BJ020R-BJ035R

OVERHOLT-GEISSENDOERFER Forceps

Catalog Number	Jaw Curve (#)	Length (in.)
BJ020R	0	7 3/4
BJ021R	1	8
BJ022R	2	8 3/4
BJ023R	3	8 7/8
BJ024R	4	8 3/4
BJ025R	5	9
BJ026R	6	8 7/8
BJ031R	1	10 1/4
BJ032R	2	10 5/8
BJ033R	3	10 3/4
BJ034R	4	10 5/8
BJ035R	5	11

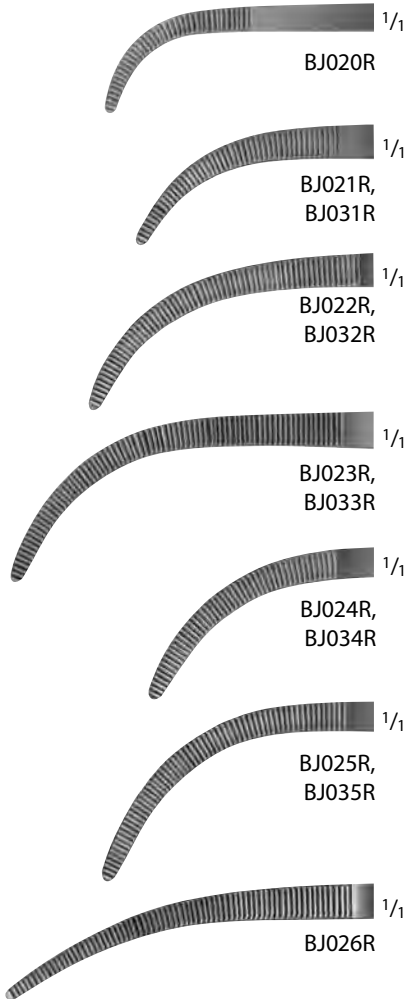

Let Us know if you could not find what you are looking for

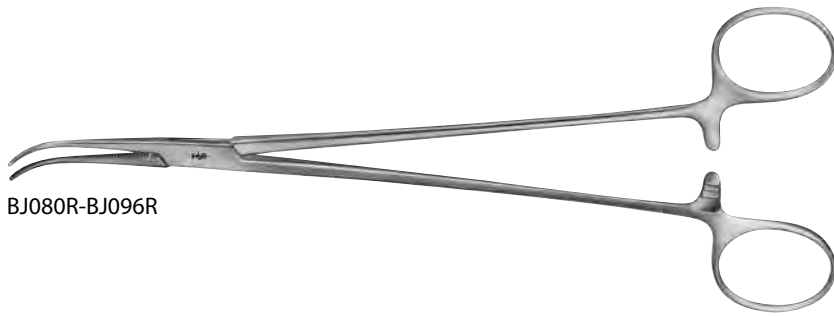

OVERHOLT Forceps

Catalog Number	Jaw Curve (#)	Length (in.)
BJO80R	0	8 1/2
BJO81R	1	8 1/4
BJO82R	2	8 3/4
BJO83R	3	8 7/8
BJO86R	6	8 7/8
BJO90R	0	11 5/8
BJO91R	1	11 5/8
BJO96R	6	11 3/4

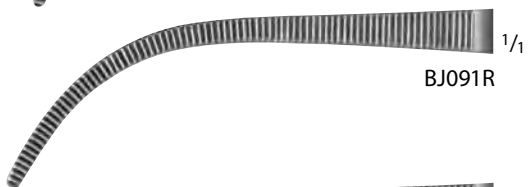
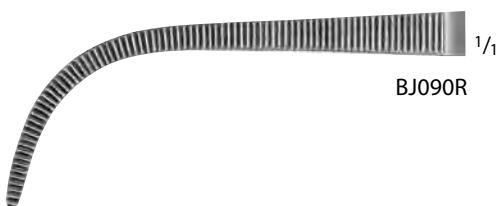
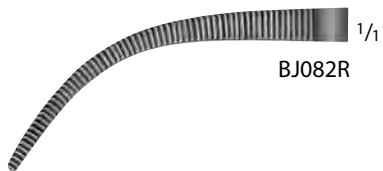
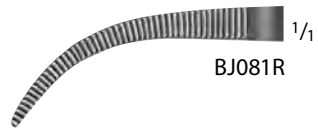

MEEKER Forceps

Catalog Number	Length (in.)
MB459R	11

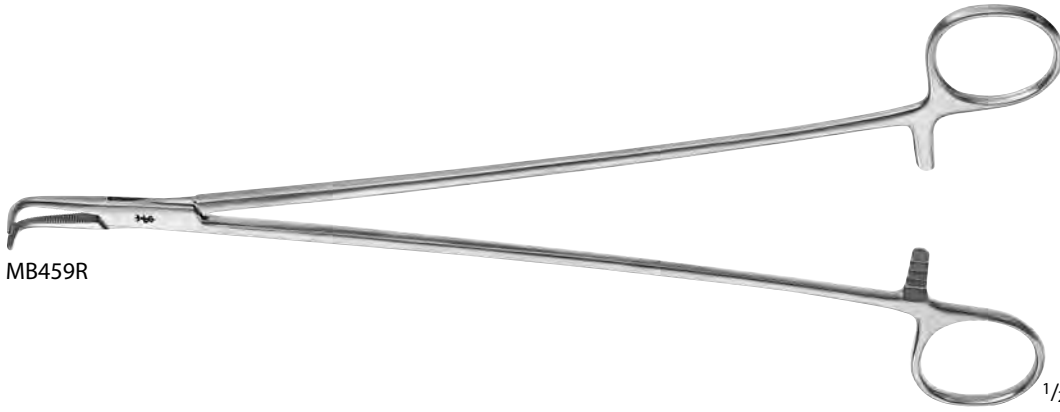

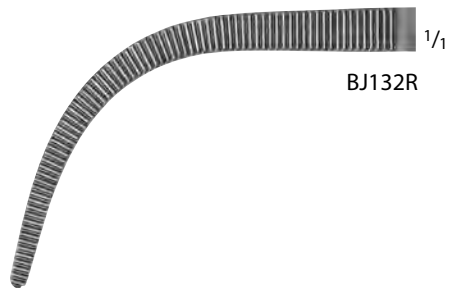
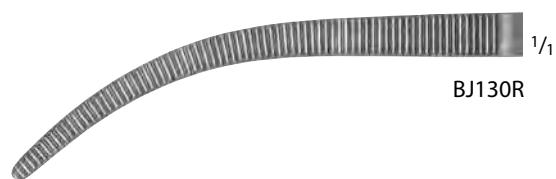
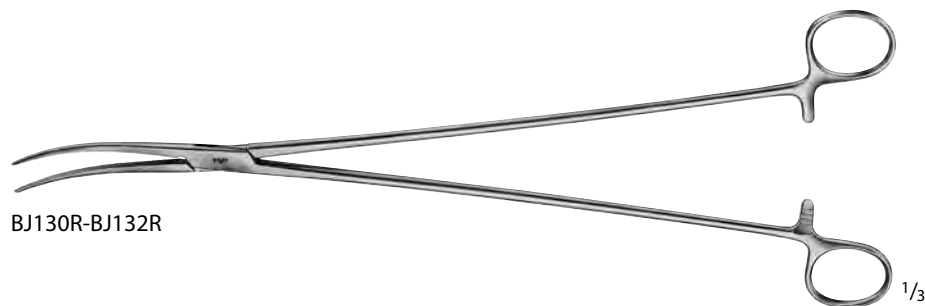
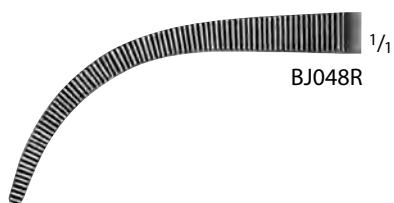
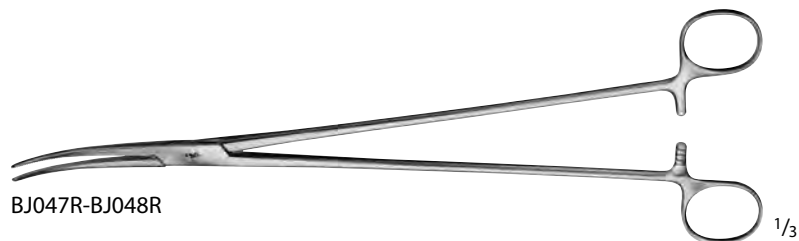

ZENKER Ligature Forceps

Catalog Number	Jaw	Length (in.)
BJ047R	SLIGHT-CVD	11 3/4
BJ048R	HEAVY-CVD	11 1/2
BJ130R	SLIGHT-CVD	13 3/4
BJ131R	CVD	13 3/4
BJ132R	HEAVY-CVD	13 3/4

MIXTER-O'SHAUGNESSY Forceps

Catalog Number	Length (in.)
BJ050R	7 1/2



BJ050R



BJ050R

FINOCHIETTO Forceps

Catalog Number	Length (in.)
BJ052R	9 5/8



BJ052R



BJ052R



BJ060R

LAHEY Forceps

Catalog Number	Length (in.)
BJ060R	8 7/8



BJ060R

MIXTER Thoracic Forceps

Catalog Number	Length (in.)
MB059R	14

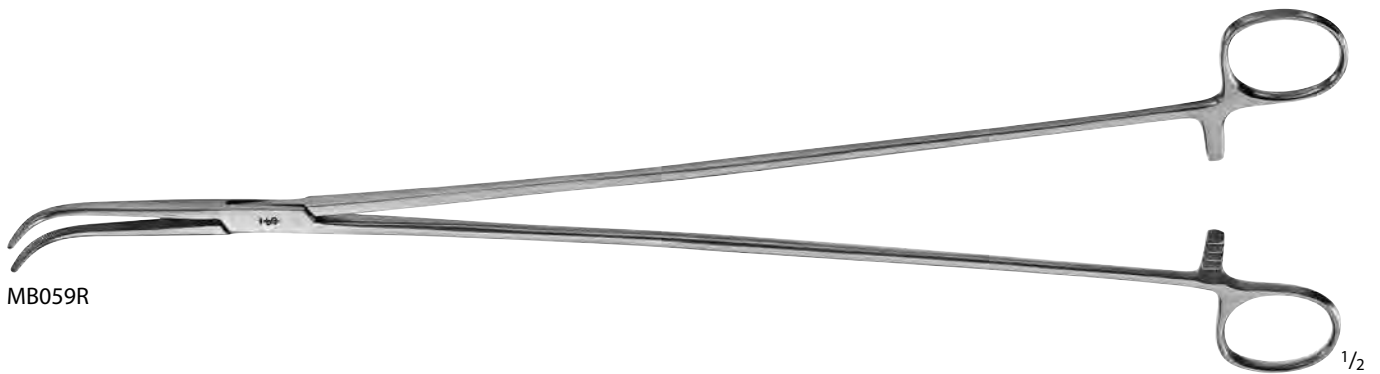

MB059R



MB059R

MIXTER Forceps, Longitudinal
 Serrations

Catalog Number	Length (in.)
BJ061R	8 3/4
BJ062R	9 3/4
BJ073R	11 1/2



BJ061R-BJ062R



BJ061R



BJ062R

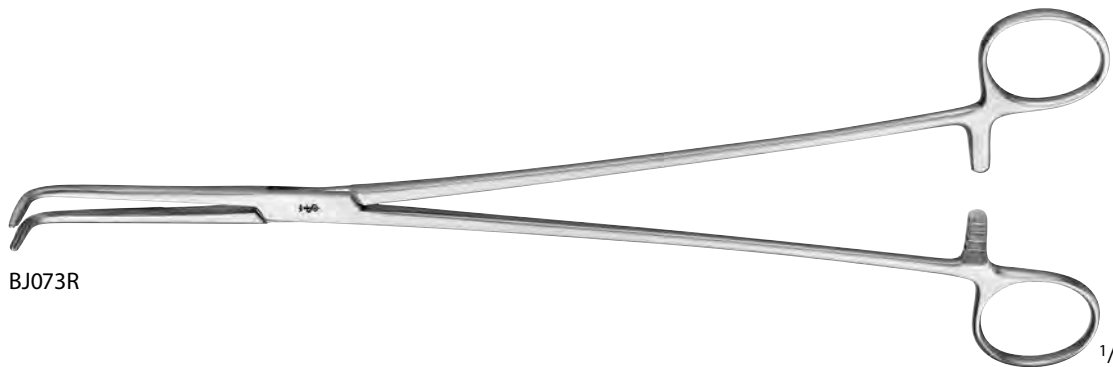

BJ073R

1/2



BJ073R

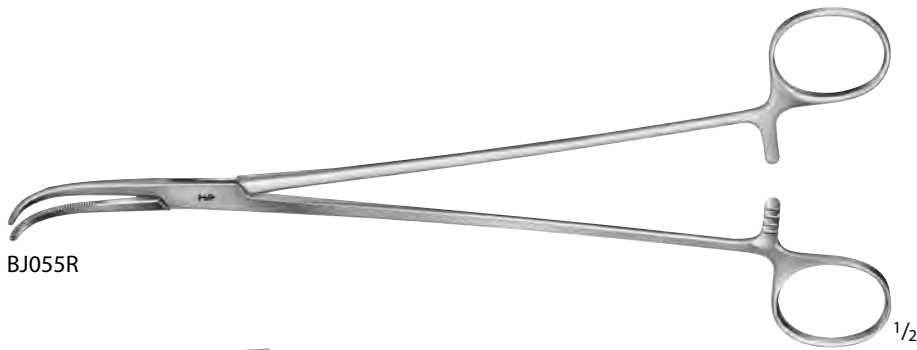

BJO55R

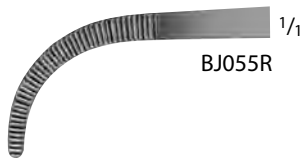

BJO55R

MIXTER Forceps

Catalog Number	Length (in.)
BJO55R	9
MB808R	14
MB924R	15 3/4

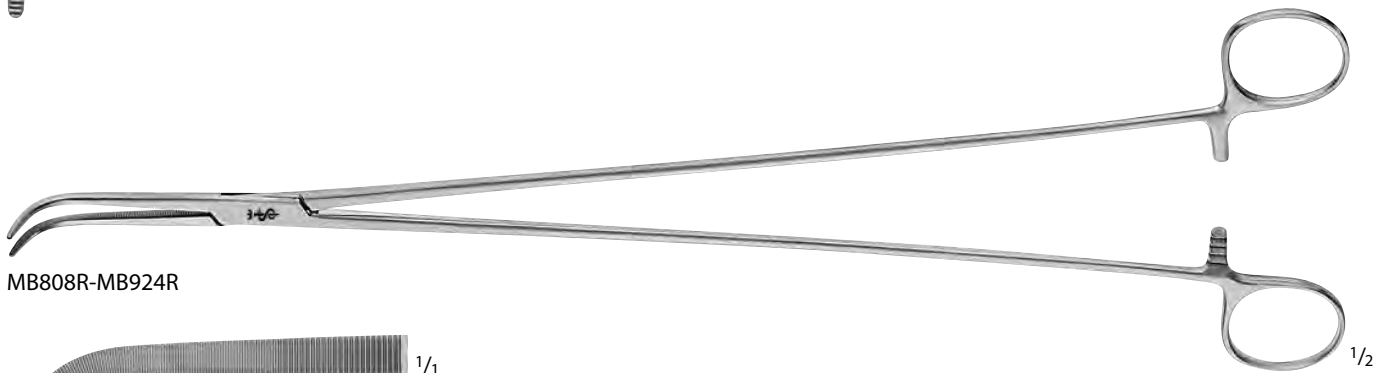

MB808R-MB924R

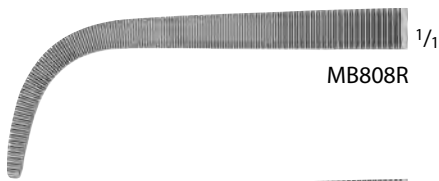

MB808R

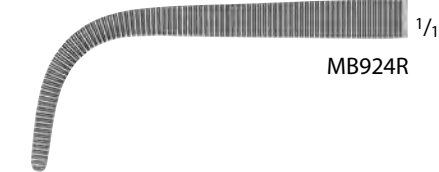

MB924R

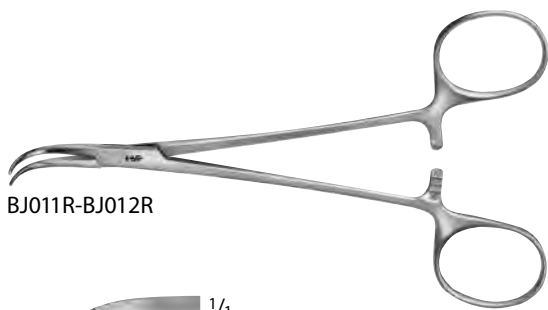

BJO11R-BJO12R



BJO11R



BJO12R

Baby MIXTER Forceps

Catalog Number	Length (in.)
BJO11R	5 1/2
BJO12R	7

HARRINGTON-MIXTER Forceps,
 Longitudinal Serrations

Catalog Number	Length (in.)
BJ072R	12 1/2

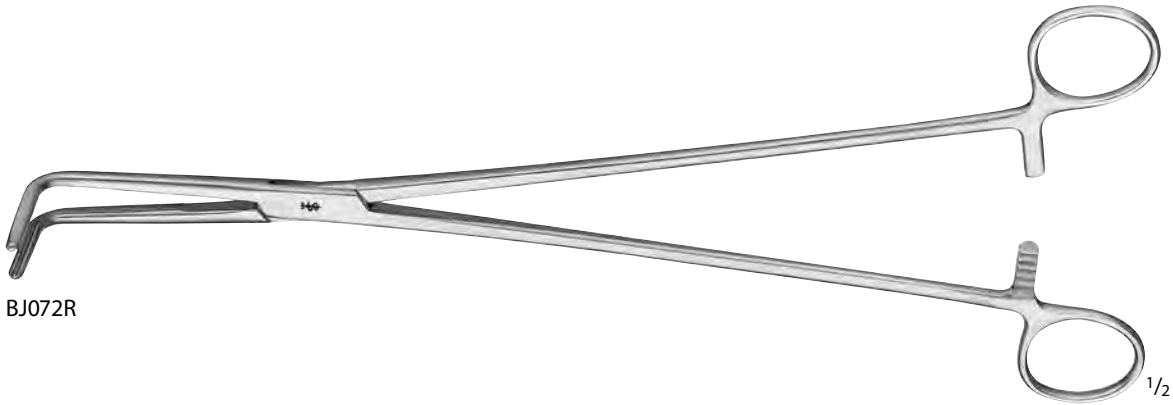

BJ072R

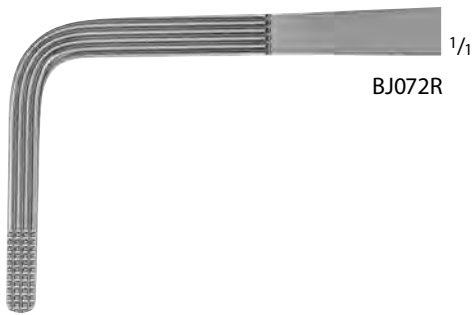

BJ072R

WIKSTROEM Forceps

Catalog Number	Length (in.)
BJ051R	8



BJ051R



BJ051R

LAWRENCE Forceps

Catalog Number	Length (in.)
BJ070R	10 5/8

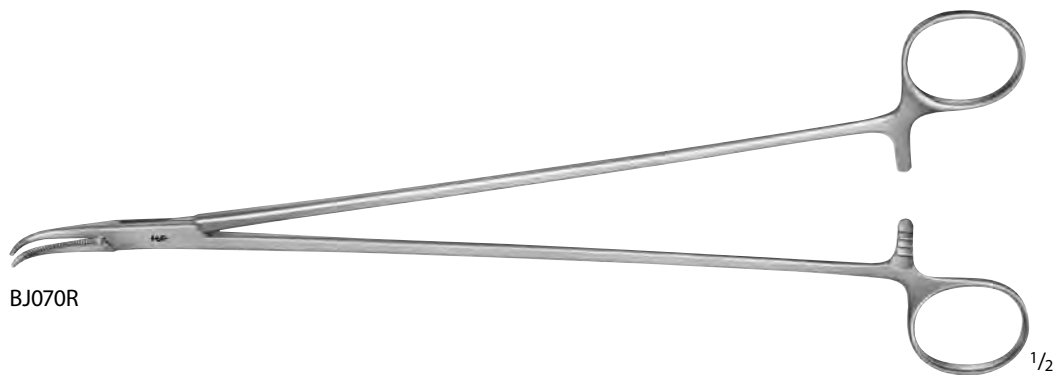

BJ070R

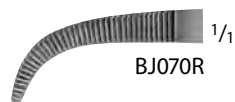

REINHOFF Swan Neck Clamp

Catalog Number	Tip	Jaw	Handle	Length (in.)
US116	SERR	CVD	CVD	10 1/4



US116



KIEBACK Forceps

Catalog Number	Jaw	Length (in.)
BJ075R	CVD, LONGITUDINAL SERR	9 1/4



BJ075R



BJ075R

COLLIER-ANDERSON Forceps

Catalog Number	Jaw	Length (in.)
MB897R	CVD, LONGITUDINAL SERR	10
MB898R	CVD, LONGITUDINAL SERR	11

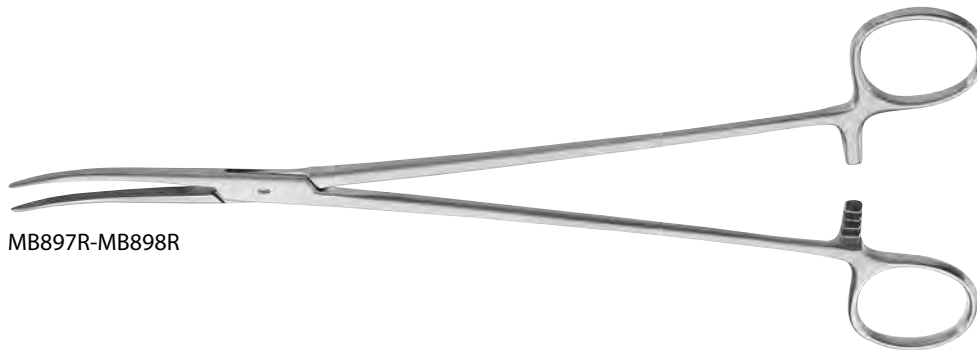

MB897R-MB898R

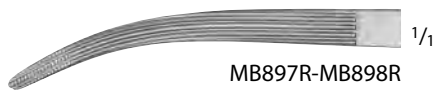

MB897R-MB898R

DEBAKEY-COLLIER Forceps

Catalog Number	Jaw	Length (in.)
MB899R	CVD, SERR	8



MB899R



MB899R



BF407R

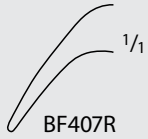

BF407R

JONES Towel Clamp

Catalog Number	Length (in.)
BF407R	3 1/4



BF426R

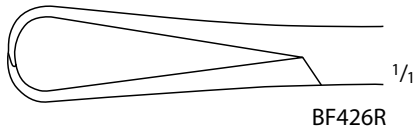

BF426R

BERNHARD Towel Clamp

Catalog Number	Length (in.)
BF426R	6 1/4



BF431R-BF433R

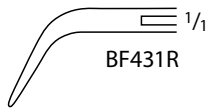

BF431R

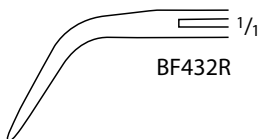

BF432R

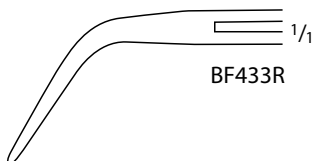

BF433R

BACKHAUS Towel Clamp

Catalog Number	Length (in.)
BF431R	3 1/2
BF432R	4 1/4
BF433R	5 1/4

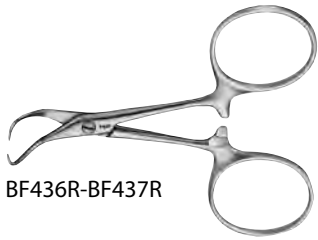

BF436R-BF437R

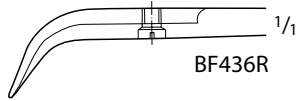

BF436R

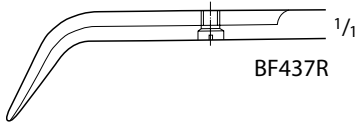

BF437R

BACKHAUS Towel Clamp, W/ Screw

Catalog Number	Length (in.)
BF436R	3 1/8
BF437R	4 1/8



BF444R

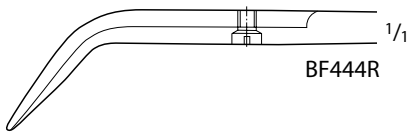

BF444R

BACKHAUS-KOCHER Towel Clamp,
 W/ Screw

Catalog Number	Length (in.)
BF444R	5 1/4



BF448R

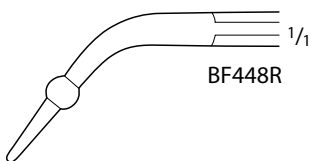

BF448R

ROEDER Towel Clamp, W/ Ball On Jaws

Catalog Number	Length (in.)
BF448R	5 1/4



BF464R

1/2



BF464R

1/1



BF460R

1/2

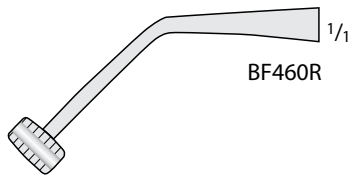

BF460R

1/1

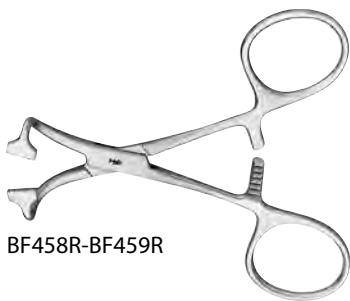

BF458R-BF459R

Non-Perforating Towel Forceps

Catalog Number	Length (in.)
BF458R	4
BF459R	5 1/2

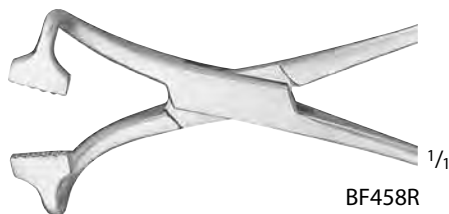

BF458R

1/1

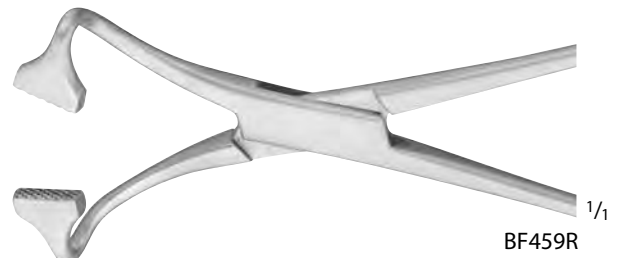

BF459R

1/1

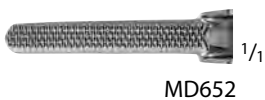
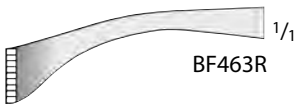

LORNA Non-Perforating Towel Clamp

Catalog Number	Length (in.)
BF461R	3 3/4
BF463R	5 1/8

Tubing Clamp, W/ Guard

Catalog Number	Jaw	Length (in.)
MD652	SERR	6
MD653	SERR	7
MD654	SERR	7 7/8

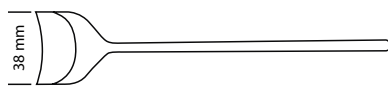
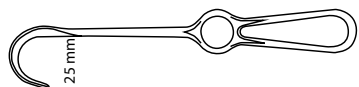

Dimensions for blade size of retractors
 1st number = depth Example: 25 x 38 mm
 2nd number = width



OL620R, MA185R, OL622R-OL624R, MD581

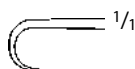

OL620R

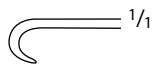

MA185R

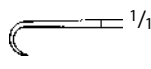

OL622R



OL623R

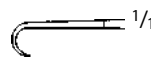

OL624R



MD581



OL621R



OL621R



OA332R-OA333R

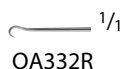

OA332R

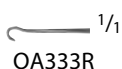

OA333R



OA334R-OA335R



OA334R



OA335R

JOSEPH Skin Hook

Catalog Number	Tip	Prongs	Tip Size (mm)	Length (in.)
OL620R	SHARP	1	-	6 1/2
MA185R	SHARP	2	2	6 1/4
OL622R	SHARP	2	3	6 1/2
OL623R	SHARP	2	6	6 1/2
OL624R	SHARP	2	8	6 1/2
MD581	SHARP	2	10	6 1/2

FREER Double Hook

Catalog Number	Tip	Tip Size (mm)	Length (in.)
OL621R	SHARP	2.0 x 3.2	6

GRAEFE Hook

Catalog Number	Tip	Length (in.)
OA332R	SHARP	5
OA333R	BLUNT	5

GUTHRIE Double Hook

Catalog Number	Tip	Length (in.)
OA334R	SHARP	5
OA335R	SHARP	5 1/8



OA336R-OA338R

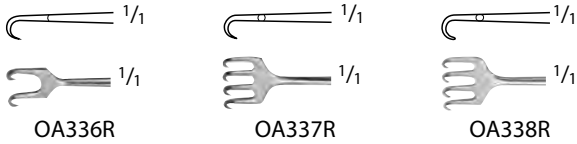

OL615R

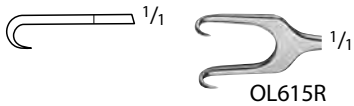

OA340R

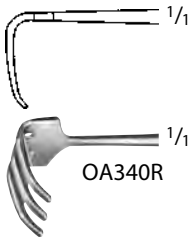

OA351R

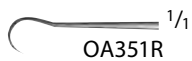

OL610R

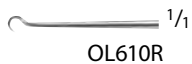

OL611R-OL612R



ROLLET Hook Retractor

Catalog Number	Tip	Blade End	Tip Size (mm)	Length (in.)
OA336R	SHARP	2 PRONGS	2.2 x 4.5	5 1/8
OA337R	SHARP	4 PRONGS	2.5 x 7.0	5 1/4
OA338R	BLUNT	4 PRONGS	2.2 x 7.0	5 1/4

MCINDOE Hook

Catalog Number	Tip	Blade End	Tip Size (mm)	Length (in.)
OL615R	SHARP	2 PRONGS	9	6

PAUL Tendon Hook

Catalog Number	Tip	Blade End	Tip Size (mm)	Length (in.)
OA340R	BLUNT	3 PRONGS	11 x 8	4 3/4

JAEGER Hook Retractor, Fine

Catalog Number	Tip	Length (in.)
OA351R	SHARP	5 1/4

KILNER Skin Hook

Catalog Number	Tip	Length (in.)
OL610R	SHARP	6 1/4

GILLIES Skin Hook

Catalog Number	Tip	Hook End	Length (in.)
OL611R	SHARP	SMALL	7
OL612R	SHARP	LARGE	7



COTTLE Hook

Catalog Number	Tip	Hook End	Length (in.)
OL617R	SHARP	ANG	6 1/4
OL619R	SHARP	HVY-CVD	6 1/4

KLEINERT-KUTZ Skin Hook

Catalog Number	Size	Tip	Tip Size (mm)	Length (in.)
OL601R	1	SHARP	2.5	6 1/4
OL602R	2	SHARP	4.2	6 1/4
OL603R	3	SHARP	4.8	6 1/4

Prong Micro Hooks

Catalog Number	Tip	Tip Size (mm)	Length (in.)
MB885R	SHARP	1	5 5/8
MB886R	SHARP	2	5 5/8
MB887R	BLUNT	2	5 5/8
MB888R	SHARP	2	5 5/8
MB889R	SHARP	5	5 5/8
MB890R	SHARP	7	5 5/8
MB891R	SHARP	10	5 5/8



BT075R



BT075R

BROM Vein Hook

Catalog Number	Length (in.)
BT075R	6 3/4



BT100R



BT100R

BERGMANN Hook

Catalog Number	Tip	Tip Size (mm)	Length (in.)
BT100R	SHARP	7	5 1/2



BT161R



BT161R

EMMET Fistula Hook

Catalog Number	Tip	Length (in.)
BT161R	SHARP	8 3/4



BT166R



BT166R

SIMON Fistula Hook

Catalog Number	Tip	Blade End	Length (in.)
BT166R	SHARP	1 PRONG	8 3/4
BT167R	SHARP	2 PRONGS	8 3/4



BT167R

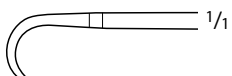

BT167R



Baby SENN-MILLER Retractor,
 Flat Handle

Catalog Number	Tip	Blade End	Blade Size (mm)	Length (in.)
BT006R	SHARP	3 PRONGS	8 x 7 / 22 x 7	6 1/8
BT007R	BLUNT	3 PRONGS	8 x 7 / 22 x 7	6 1/8

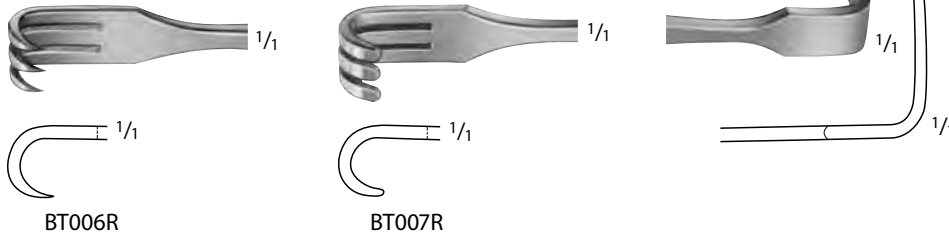

SENN-MILLER Retractor

Catalog Number	Tip	Blade End	Blade Size (mm)	Length (in.)
BT008R	SHARP	3 PRONGS	8 x 7 / 18 x 5.5	6 1/2

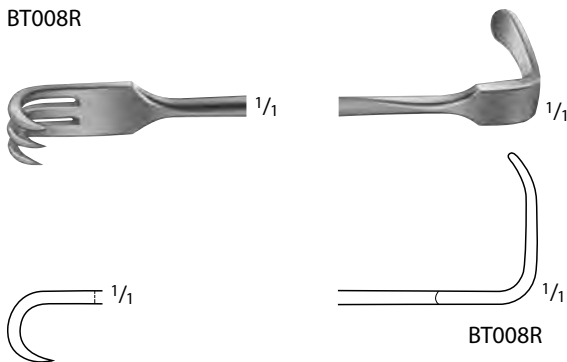

SENN Retractor, Round Tapered Handle

Catalog Number	Tip	Blade End	Blade Size (mm)	Length (in.)
MG276R	SHARP	3 PRONGS	9 x 10 / 22 x 7	6 1/4
MG277R	BLUNT	3 PRONGS	9 x 10 / 22 x 7	6 1/4

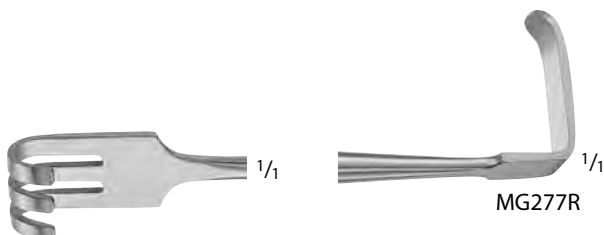
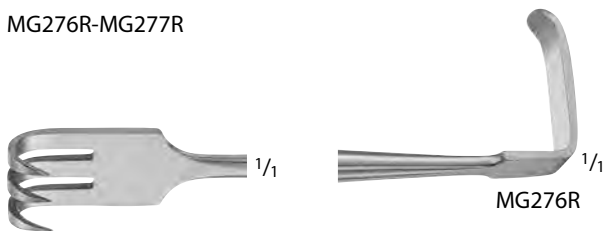

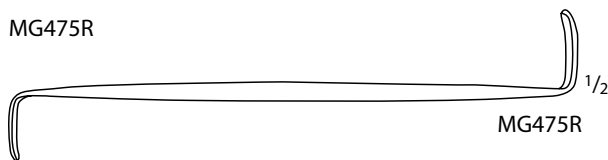
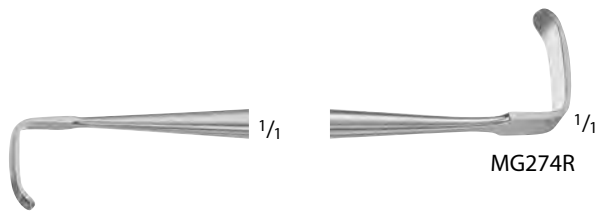
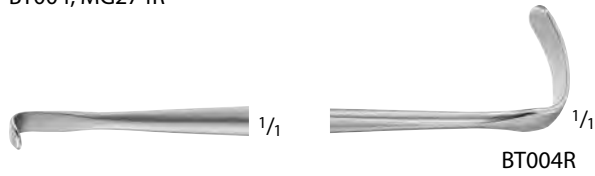

RAGNELL Retractor

Catalog Number	Blade Size (mm)	Length (in.)
BT004R	3 x 5 / 6.3 x 14	6
MG274R	3 x 11 / 5.4 x 17	6

DAVIS Double Ended Retractor

Catalog Number	Blade Size (mm)	Length (in.)
MG475R	19 x 9 / 23 x 6.4	6

Double Ended Retractor

Catalog Number	Blade Size (mm)	Length (in.)
BT187R	20 x 15 / 20 x 19	8

GOELET Retractor

Catalog Number	Blade Size (mm)	Length (in.)
MD497	30 x 32 / 35 x 40	7 1/2



BT010R



BT020R

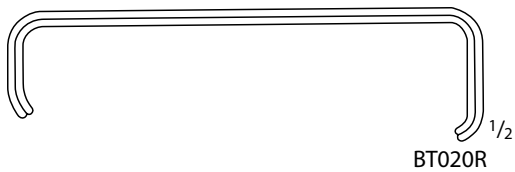

BT021R



MB984R

LUER Retractor

Catalog Number	Blade Size (mm)	Length (in.)
BT010R	10 x 8 / 12 x 11	4 1/4

FARABEUF Retractor, 2/Set

Catalog Number	Blade Size (mm)	Length (in.)
BT020R	25 x 10 / 32 x 12 22 x 10 / 29 x 12	5
BT021R	23 x 16 / 28 x 16 19 x 16 / 24 x 16	6

MAYO-COLLINS Retractor, 2/Set

Catalog Number	Blade Size (mm)	Length (in.)
MB984R	31 x 20 / 30 x 18 28 x 19 / 26 x 17	5 7/8

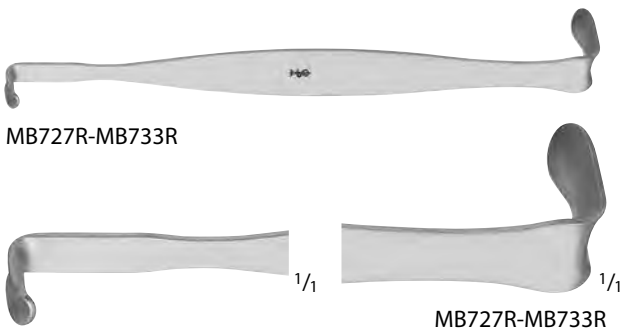
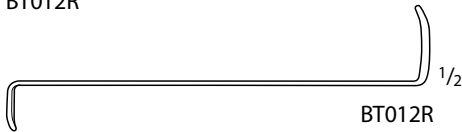
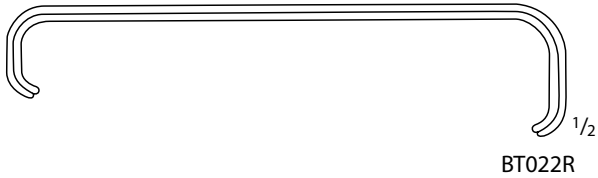

COLLIN Retractor, 2/Set

Catalog Number	Blade Size (mm)	Length (in.)
BT022R	21 x 14 / 32 x 16 17 x 14 / 28 x 16	6

CRILE Retractor

Catalog Number	Blade Size (mm)	Length (in.)
BT012R	11 x 4 / 19 x 6	4 1/4

CRILE Retractor

Catalog Number	Size	Blade Size (mm)	Length (in.)
MB727R	1	3 x 11 / 6 x 21	4 1/4
MB728R	2	6 x 13 / 10 x 21	6 1/8
MB729R	3	16 x 25 / 17 x 35	6 1/4
MB730R	4	22 x 29 / 29 x 44	7
MB731R	5	29 x 41 / 35 x 51	7
MB732R	6	32 x 64 / 35 x 70	7 7/8
MB733R	7	41 x 76 / 51 x 79	8 7/8



BT011R

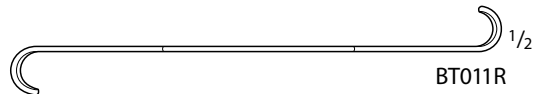

BT011R

ROSE Tracheal Retractor

Catalog Number	Blade Size (mm)	Length (in.)
BT011R	10 x 12 / 11 x 15	5 1/8



MG474R

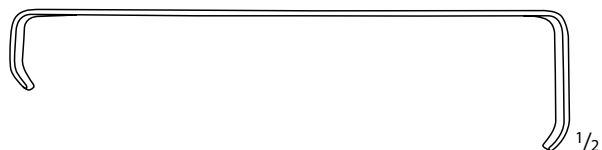

MG474R

Children's Hospital Retractor

Catalog Number	Blade Size (mm)	Length (in.)
MG474R	11 x 22 / 14 x 35	4 1/2



BT025R



BT025R

PARKER Retractor, 2/Set

Catalog Number	Blade Size (mm)	Length (in.)
BT025R	22 x 15 / 22 x 15 18 x 15 / 18 x 15	5 1/4
BT026R	31 x 25 / 27 x 25 31 x 25 / 27 x 25	7



BT026R

ROUX Retractor

Catalog Number	Blade Size (mm)	Length (in.)
BT034R	20 x 22 / 25 x 29	6
BT035R	25 x 26 / 30 x 38	6 1/4
BT036R	28 x 29 / 33 x 44	6 3/4



BT034R-BT036R

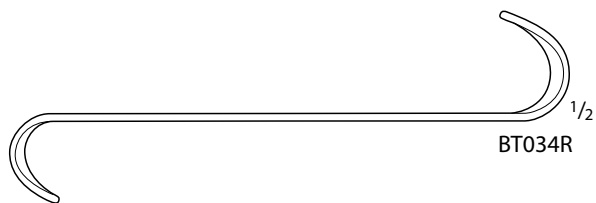

BT034R

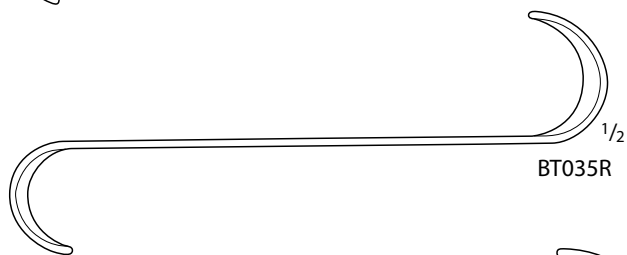

BT035R

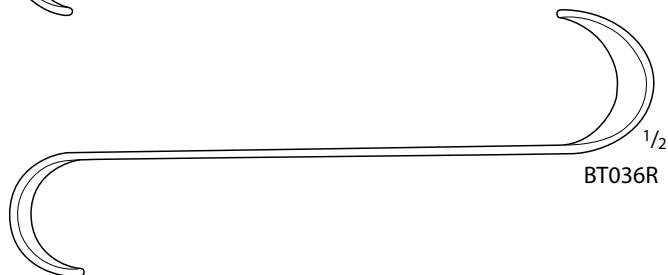

BT036R



BT030R-BT033R



BT031R 1/2



BT032R 1/2

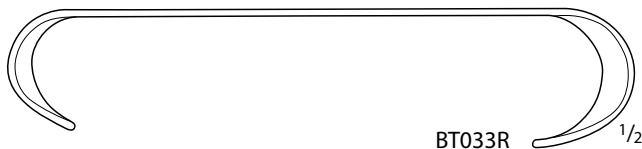

BT033R 1/2



MB584R-MB585R

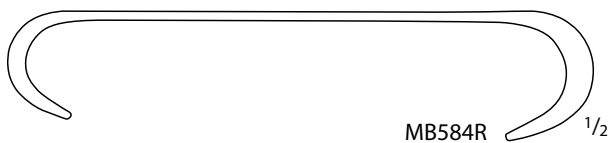

MB584R 1/2

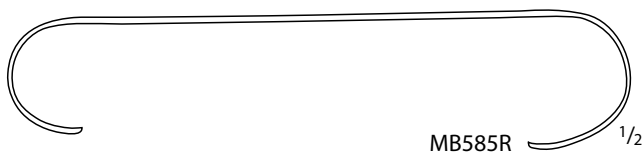

MB585R 1/2



BT029R



BT029R 1/2

ROUX Retractor

Catalog Number	Blade Size (mm)	Length (in.)
BT030R	COMPLETE SET BT031R-BT033R	-
BT031R	21 x 22 / 27 x 28	5 3/4
BT032R	26 x 26 / 32 x 26	6 1/8
BT033R	30 x 30 / 36 x 44	6 1/2

ROUX Retractor

Catalog Number	Blade Size (mm)	Length (in.)
MB584R	25 x 26 / 30 x 37	6 1/2
MB585R	28 x 28 / 29 x 40	6 1/2

ROUX Retractor, Long

Catalog Number	Blade Size (mm)	Length (in.)
BT029R	28 x 28 / 46 x 28	7 1/2



BT040R

MATHIEU Retractor, 2/Set

Catalog Number	Blade Size (mm)	Length (in.)
BT040R	42 x 13 / 41 x 13 45 x 25 / 40 x 25	7 7/8

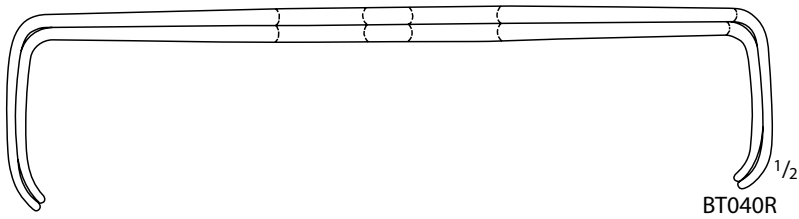

BT040R



BT041R

US Army Retractor, 2/Set

Catalog Number	Blade Size (mm)	Length (in.)
BT041R	26 x 15 / 22 x 15 43 x 15 / 39 x 15	8 3/4



BT041R



BT111R-BT119R



BT111R



BT116R



BT112R



BT117R



BT113R



BT118R



BT114R



BT119R



BT121R-BT129R



BT121R



BT126R



BT122R



BT127R



BT123R



BT128R



BT124R



BT129R

Hook, Small Curve

Catalog Number	Tip	Blade End	Blade Size (mm)	Length (in.)
BT111R	SHARP	1 PRONG	-	6 1/2
BT112R	SHARP	2 PRONGS	5.0 x 4.2	6 1/2
BT113R	SHARP	3 PRONGS	5.0 x 7.0	6 1/2
BT114R	SHARP	4 PRONGS	5.0 x 9.5	6 1/2
BT116R	BLUNT	1 PRONG	-	6 1/2
BT117R	BLUNT	2 PRONGS	4.5 x 4.2	6 1/2
BT118R	BLUNT	3 PRONGS	4.5 x 7.0	6 1/2
BT119R	BLUNT	4 PRONGS	4.5 x 9.0	6 1/2

Hook, Large Curve

Catalog Number	Tip	Blade End	Blade Size (mm)	Length (in.)
BT121R	SHARP	1 PRONG	-	6 1/2
BT122R	SHARP	2 PRONGS	7.5 x 7.5	6 1/2
BT123R	SHARP	3 PRONGS	7.5 x 10.0	6 1/2
BT124R	SHARP	4 PRONGS	7.5 x 14.0	6 1/2
BT126R	BLUNT	1 PRONG	-	6 1/2
BT127R	BLUNT	2 PRONGS	6.8 x 7.5	6 1/2
BT128R	BLUNT	3 PRONGS	6.8 x 10.0	6 1/2
BT129R	BLUNT	4 PRONGS	6.8 x 14.0	6 1/2

CRILE Hook and Dissector

Catalog Number	Length (in.)
MB060R	11 3/4



MB060R



MB060R



MB060R



BT172R

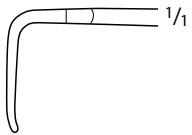

BT172R

KLAPP Tendon Hook

Catalog Number	Tip	Blade End	Blade Size (mm)	Length (in.)
BT172R	BLUNT	4 PRONGS	15 x 11	6 7/8



BT179R

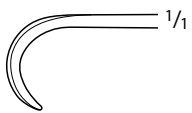

BT179R

Vein Retractor

Catalog Number	Blade Size (mm)	Length (in.)
BT179R	10 x 13	6 1/4



BT182R-BT183R



BT182R



BT183R

KOENIG Vein Retractor

Catalog Number	Blade Size (mm)	Length (in.)
BT182R	13 x 13	7
BT183R	12 x 16	7



BT193R-BT198R

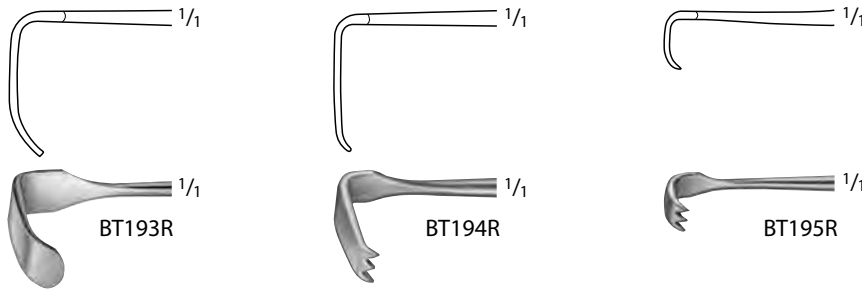

BT193R

BT194R

BT195R

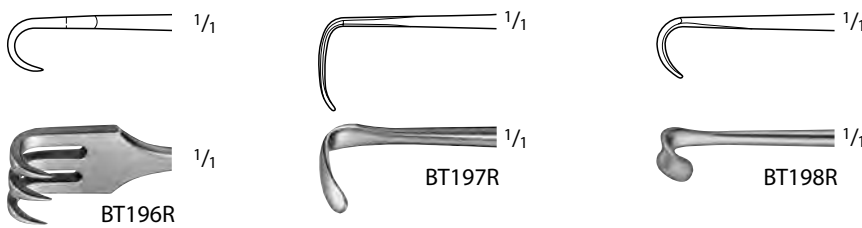

BT196R

BT197R

BT198R



BT190R



BT190R



BT184R-BT185R



BT184R



BT185R

MEYERDING Thumb Retractor

Catalog Number	Blade Size	Size (#)	Blade Size (mm)	Length (in.)
BT193R	A	1	18 x 7	7
BT194R	B	2	16 x 5	7
BT195R	C	3	7 x 4	7
BT196R	D	4	5 x 10	7
BT197R	E	5	11 x 4	7
BT198R	F	6	6 x 4	7

CUSHING-KOCHER Retractor

Catalog Number	Blade Size (mm)	Length (in.)
BT190R	10 x 10	6 7/8

CUSHING Vein Retractor

Catalog Number	Blade Size (mm)	Length (in.)
BT184R	10 x 13	8
BT185R	14 x 18	8

CUSHING Vein Retractor
 (continued)

Catalog Number	Blade Size (mm)	Length (in.)
BT200R	14 x 11	9 3/4
BT202R	22 x 15	9 3/4



BT200R-BT202R



BT200R



BT202R

CUSHING Vein Retractor

Catalog Number	Blade Size (mm)	Length (in.)
MB912R	14	12 1/2
MB913R	14	14
MB914R	14	16



MB912R-MB914R



MB912R-MB914R

GIL VERNET Retractor, Malleable

Catalog Number	Blade Size (mm)	Length (in.)
MB766R	9	11 1/4
MB767R	11	11 1/4
MB768R	13	11 1/4
MB769R	18	11 1/4



MB766R-MB769R



MB766R-MB769R



BT221R

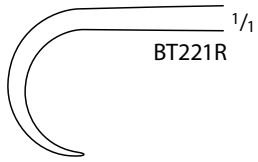

BT221R



BT222R-BT230R

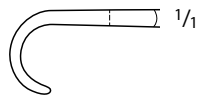
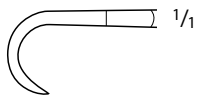

BT222R



BT227R



BT223R



BT228R



BT224R



BT229R



BT225R



BT230R

VOLKMANN Retractor

Catalog Number	Tip	Blade End	Blade Size (mm)	Length (in.)
BT221R	SHARP	1 PRONG	8.5 x 8	8 3/4
BT222R	SHARP	2 PRONGS	9 x 8	8 7/8
BT223R	SHARP	3 PRONGS	9 x 13	8 7/8
BT224R	SHARP	4 PRONGS	9 x 19	8 7/8
BT225R	SHARP	6 PRONGS	9 x 29	8 7/8
BT227R	BLUNT	2 PRONGS	8.5 x 12	8 7/8
BT228R	BLUNT	3 PRONGS	8.5 x 13	8 7/8
BT229R	BLUNT	4 PRONGS	8.5 x 19	8 7/8
BT230R	BLUNT	6 PRONGS	8.5 x 29	8 7/8



BT240R-BT241R

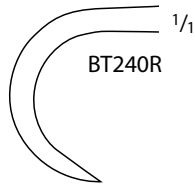

BT240R

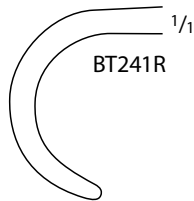

BT241R



BT242R-BT265R

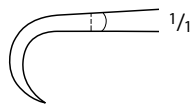

BT242R

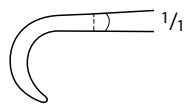

BT257R

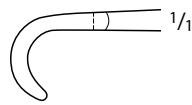

BT252R



BT243R



BT259R



BT253R



BT244R



BT260R



BT254R



BT246R



BT261R



BT256R



BT248R



BT265R



BT258R

VOLKMANN Retractor, Small

Catalog Number	Tip	Blade End	Blade Size (mm)	Length (in.)
BT240R	SHARP	1 PRONG	-	8 3/4
BT241R	BLUNT	1 PRONG	-	8 3/4
BT242R	SHARP	2 PRONGS	9 x 8	8 3/4
BT243R	SHARP	3 PRONGS	9 x 13	8 3/4
BT244R	SHARP	4 PRONGS	9 x 19	8 3/4
BT246R	SHARP	6 PRONGS	9 x 29	8 3/4
BT248R	SHARP	8 PRONGS	9 x 40	8 3/4
BT257R	SEMI-S	2 PRONGS	8.5 x 8	8 3/4
BT259R	SEMI-S	3 PRONGS	8.5 x 13	8 3/4
BT260R	SEMI-S	4 PRONGS	8.5 x 19	8 3/4
BT261R	SEMI-S	6 PRONGS	8.5 x 29	8 3/4
BT265R	SEMI-S	8 PRONGS	8.5 x 40	8 3/4
BT252R	BLUNT	2 PRONGS	8 x 8	8 3/4
BT253R	BLUNT	3 PRONGS	8 x 13	8 3/4
BT254R	BLUNT	4 PRONGS	8 x 19	8 3/4
BT256R	BLUNT	6 PRONGS	8 x 29	8 3/4
BT258R	BLUNT	8 PRONGS	8 x 40	8 3/4

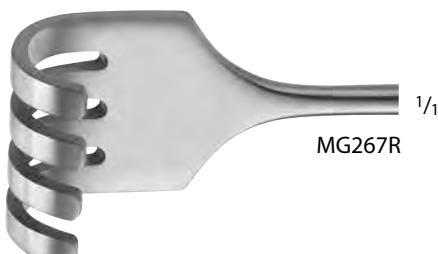
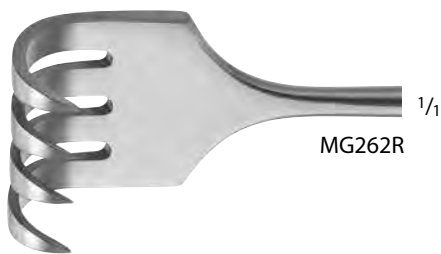
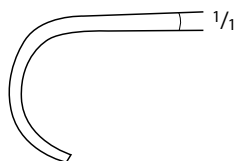
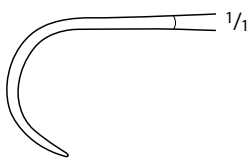

VOLKMANN Retractor, US Version

Catalog Number	Tip	Blade End	Blade Size (mm)	Length (in.)
MG260R	SHARP	2 PRONGS	20 x 11	8 3/4
MG261R	SHARP	3 PRONGS	20 x 18	8 3/4
MG262R	SHARP	4 PRONGS	20 x 26	8 3/4
MG264R	SHARP	6 PRONGS	20 x 40	8 3/4
MG265R	BLUNT	2 PRONGS	20 x 11	8 3/4
MG266R	BLUNT	3 PRONGS	20 x 18	8 3/4
MG267R	BLUNT	4 PRONGS	20 x 26	8 3/4
MG269R	BLUNT	6 PRONGS	20 x 40	8 3/4



BT262R-BT276R

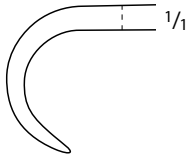

BT262R



BT263R



BT264R



BT266R

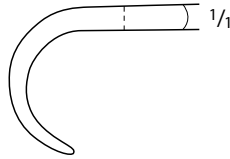

BT272R



BT273R



BT274R



BT276R

KOCHER Retractor, Large

Catalog Number	Tip	Blade End	Blade Size (mm)	Length (in.)
BT262R	SEMI-S	2 PRONGS	16 x 9	8 3/4
BT263R	SEMI-S	3 PRONGS	16 x 14	8 3/4
BT264R	SEMI-S	4 PRONGS	16 x 20	8 3/4
BT266R	SEMI-S	6 PRONGS	16 x 30	8 3/4
BT272R	BLUNT	2 PRONGS	15.5 x 9	8 3/4
BT273R	BLUNT	3 PRONGS	15.5 x 14	8 3/4
BT274R	BLUNT	4 PRONGS	15.5 x 20	8 3/4
BT276R	BLUNT	6 PRONGS	15.5 x 30	8 3/4



BT278R-BT279R

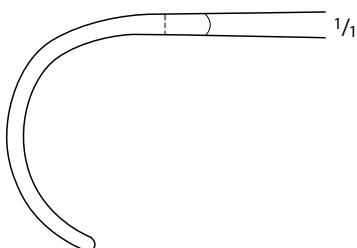

BT279R



BT278R

KOERTE Retractor

Catalog Number	Tip	Blade End	Blade Size (mm)	Length (in.)
BT279R	SEMI-S	8 PRONGS	26 x 40	9 1/2
BT278R	BLUNT	8 PRONGS	26 x 40	9 1/2

ISRAEL Retractor

Catalog Number	Tip	Blade End	Blade Size (mm)	Length (in.)
BT284R	BLUNT	4 PRONGS	39 x 40	10
BT285R	BLUNT	5 PRONGS	47 x 51	10
BT286R	BLUNT	6 PRONGS	53 x 62	10
BT287R	BLUNT	6 PRONGS	70 x 70	10



BT284R-BT287R

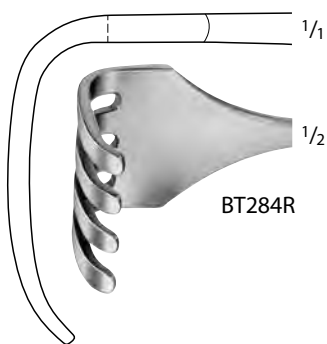

BT284R

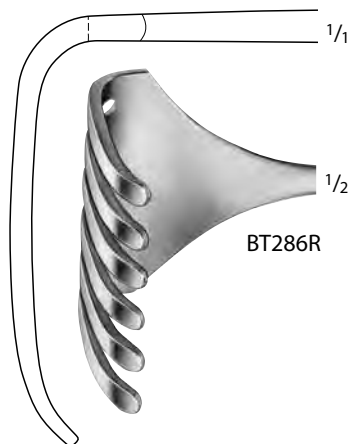

BT286R

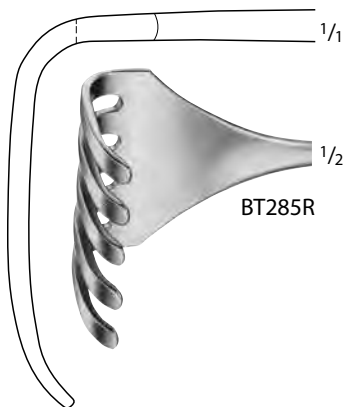

BT285R

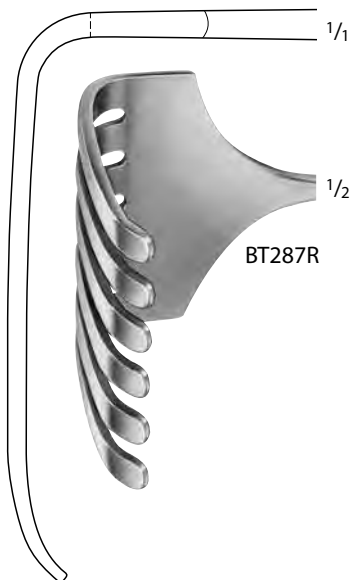

BT287R



MG284R



MG284R



BT293R-BT296R



BT293R



BT296R



BT294R

ISRAEL Retractor, T-Handle

Catalog Number	Tip	Blade End	Blade Size (mm)	Length (in.)
MG284R	BLUNT	4 PRONGS	46 x 40	7 1/2

MURPHY Retractor

Catalog Number	Tip	Blade End	Length (in.)
BT293R	SHARP	3 PRONGS	7 3/4
BT294R	SHARP	4 PRONGS	7 3/4
BT296R	BLUNT	4 PRONGS	7 3/4

KOERTE-WAGNER Retractor

Catalog Number	Tip	Blade End	Blade Size (mm)	Length (in.)
BT290R	SEMI-S	8 PRONGS	28 x 40	11



BT290R

BT290R



BT311R-BT316R

LANGENBECK Retractor

Catalog Number	Blade Size (mm)	Length (in.)
BT311R	30 x 10	9
BT315R	40 x 10	9
BT316R	43 x 13	9

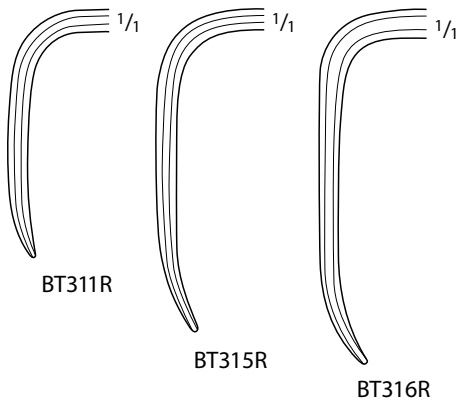

BT351R-BT353R



SAUERBRUCH Retractor

Catalog Number	Blade Size (mm)	Length (in.)
BT351R	46 x 16	8 7/8
BT352R	55 x 22	8 7/8
BT353R	72 x 19	8 7/8

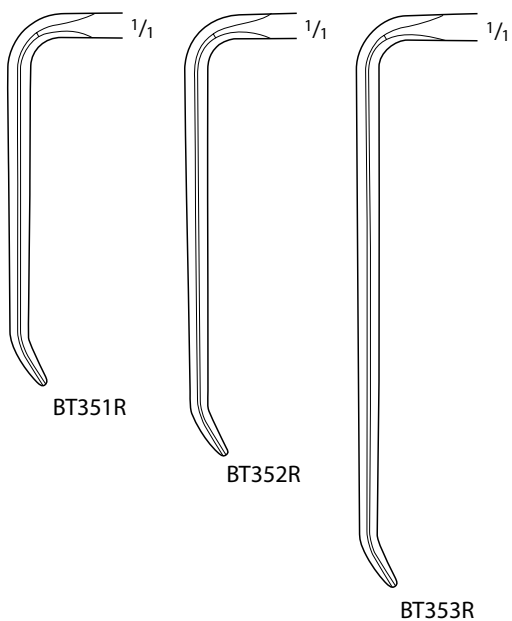



BT354R-BT365R

KOCHER-LANGENBECK Retractor

Catalog Number	Blade Size (mm)	Length (in.)
BT354R	25 x 6	8 1/2
BT356R	35 x 8	8 1/2
BT357R	35 x 11	8 1/2
BT358R	35 x 15	8 1/2
BT359R	41 x 11	8 1/2
BT361R	55 x 11	8 1/2
BT363R	70 x 14	8 1/2
BT364R	80 x 12	8 1/2
BT365R	80 x 16	8 1/2

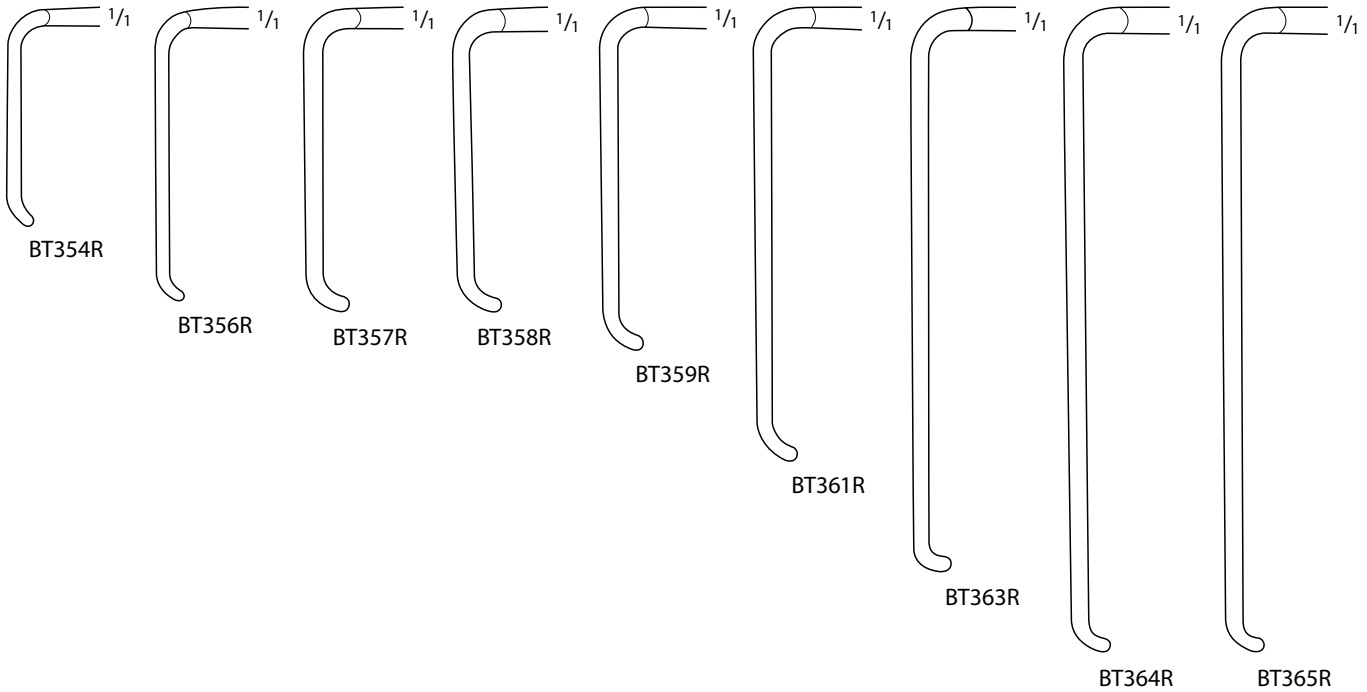

MB785R



LAHEY Goiter Retractor

Catalog Number	Blade Size (mm)	Length (in.)
MB785R	24 x 8	7 7/8



MB785R



MB748R

MCBURNEY Thyroid Retractor

Catalog Number	Blade Size (mm)	Length (in.)
MB748R	20 x 10	7 1/2



MB748R



BT404R-BT406R

MIDDELDORPF Retractor

Catalog Number	Blade Size (mm)	Length (in.)
BT404R	15 x 15	8 3/4
BT405R	20 x 22	8 1/2
BT406R	28 x 28	9 1/4



BT404R

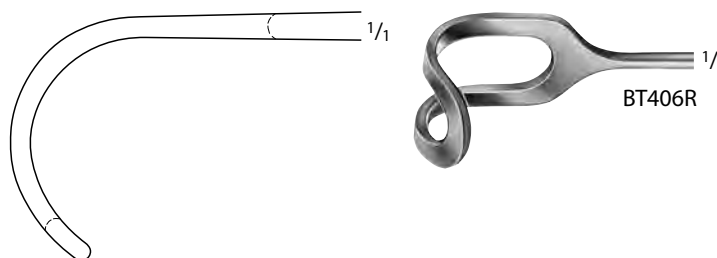

BT406R

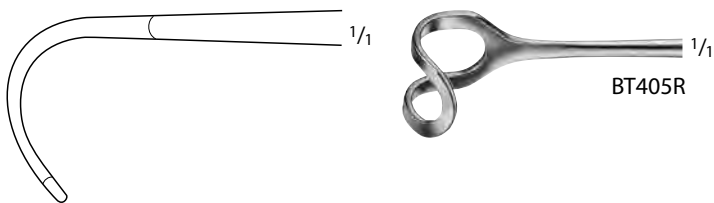

BT405R



BT408R

GREENE Retractor

Catalog Number	Blade Size (mm)	Length (in.)
BT408R	28 x 22	8 7/8

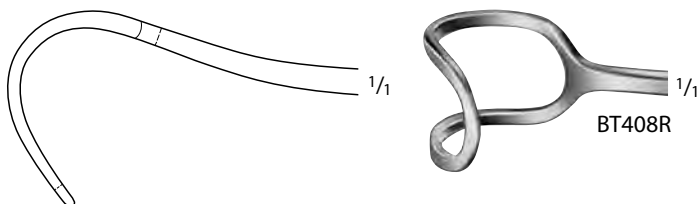

BT408R



DOCKHORN Cheek Retractor

Catalog Number	Blade Size (mm)	Length (in.)
DO438R	40 x 12	8 1/4
DO439R	55 x 14	8 1/4

DO438R-DO439R

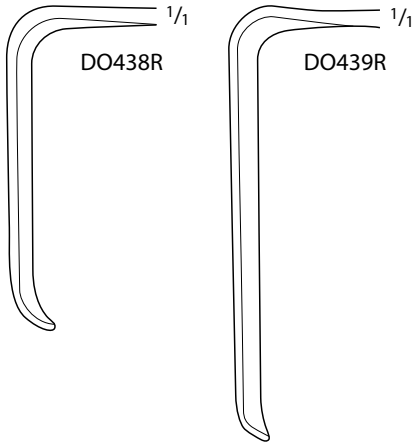

HOESEL Retractor

Catalog Number	Blade Size (mm)	Length (in.)
BT442R	100 x 30	9 3/4
BT446R	220 x 40	9 3/4

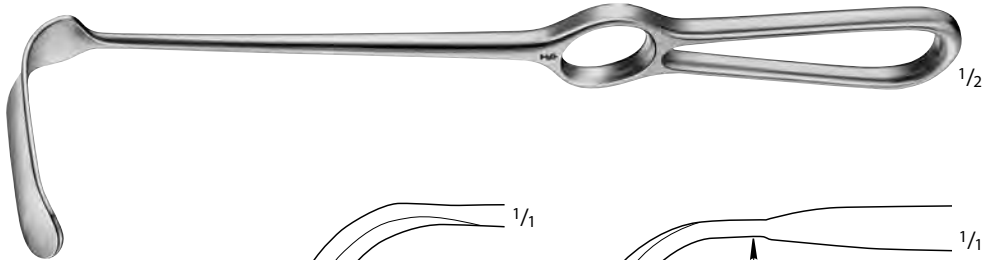

BT442R-BT446R

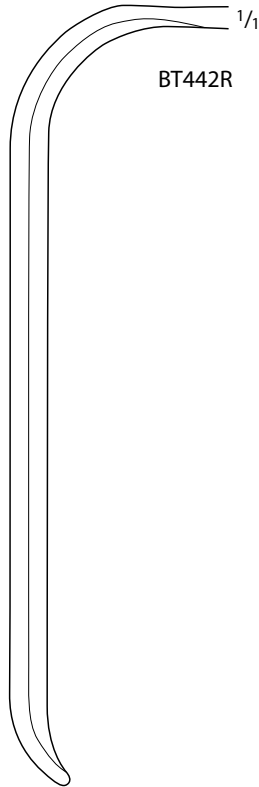

BT442R

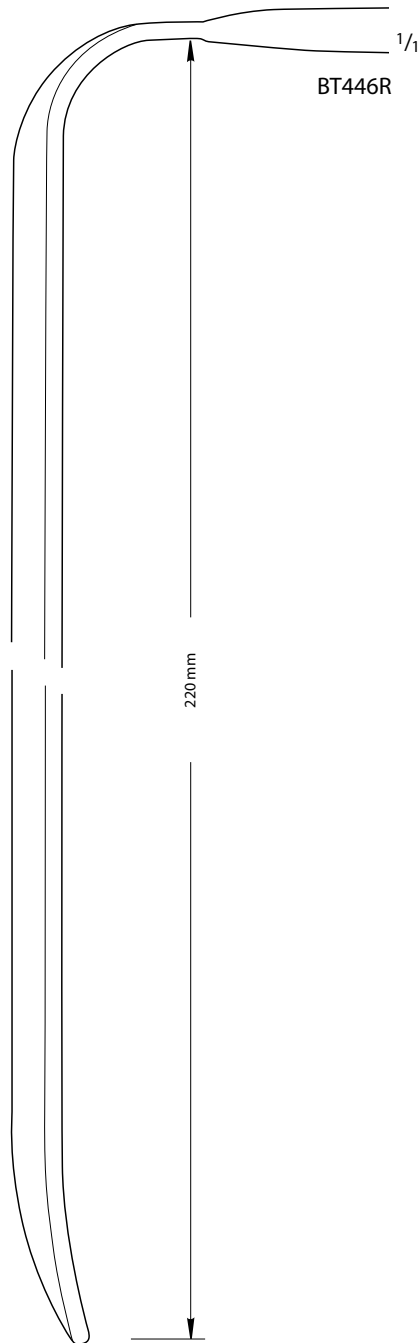

BT446R

220 mm

KOCHER Retractor

Catalog Number	Blade Size (mm)	Length (in.)
BT461R	80 x 42	9 3/4
BT462R	80 x 50	9 3/4
BT463R	80 x 60	9 3/4



BT461R-BT463R

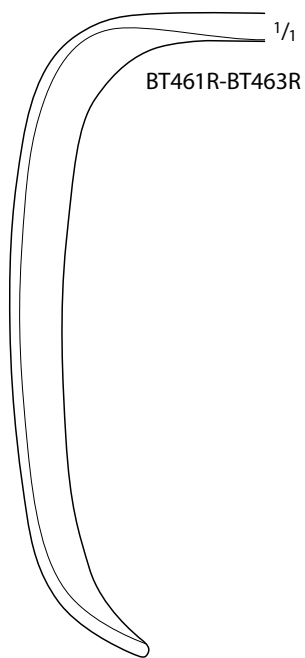



BT464R



KRAEMER Retractor

Catalog Number	Blade Size (mm)	Length (in.)
BT464R	66 x 10	8 1/4



BT465R

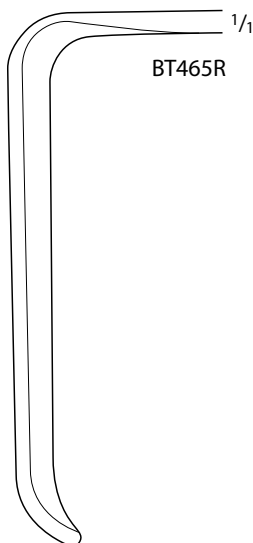

CASPAR Retractor

Catalog Number	Blade Size (mm)	Length (in.)
BT465R	67 x 17	8 1/4



BT450R-BT469R

MIASPAS® Mini ALIF LANGENBECK Retractor

Catalog Number	Blade Size (mm)	Length (in.)
BT450R	125 x 20	8 1/4
BT451R	125 x 35	8 1/4
BT466R	80 x 20	8 1/4
BT467R	110 x 20	8 1/4
BT468R	80 x 35	8 1/4
BT469R	110 x 35	8 1/4

RICHARDSON-EASTMAN Retractor

Catalog Number	Description	Tip	Length (in.)
BT470R	2/SET (BT471R, BT472R)	-	-
BT471R	-	SM	9 3/4
BT472R	-	LRG	10 5/8

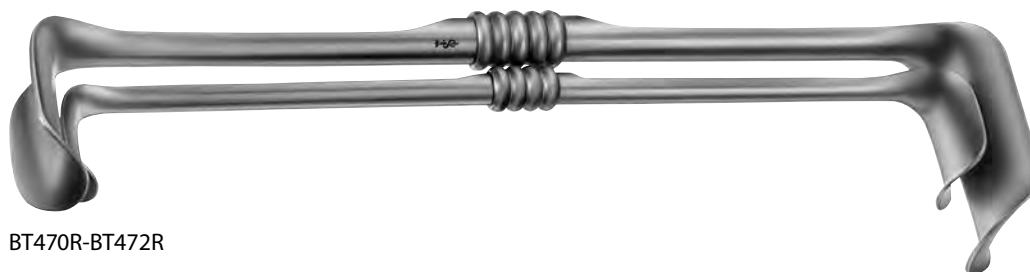

BT470R-BT472R

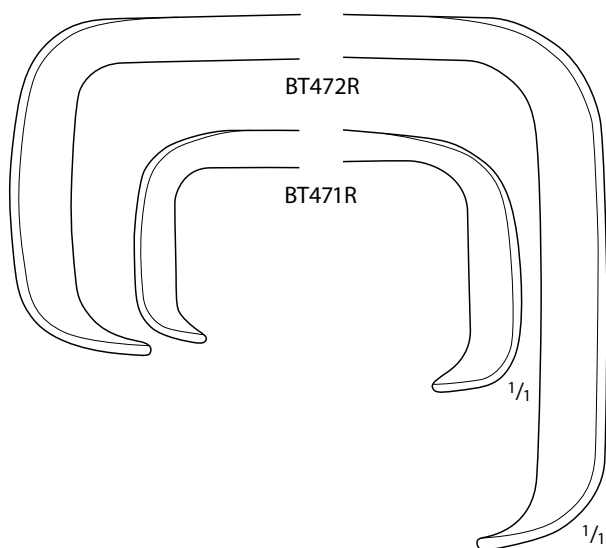



BT475R-BT477R

RICHARDSON Retractor

Catalog Number	Blade Size (mm)	Blade Size (in.)	Length (in.)
BT475R	23 x 20	1 x 3/4	9 1/2
BT476R	30 x 29	1 1/4 x 1 1/8	9 1/2
BT477R	37 x 37	1 1/2 x 1 1/2	9 1/2
BT478R	47 x 21	2 x 3/4	9 1/2

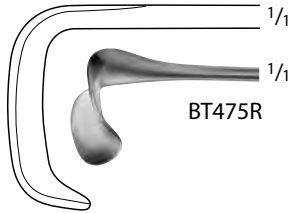

BT475R

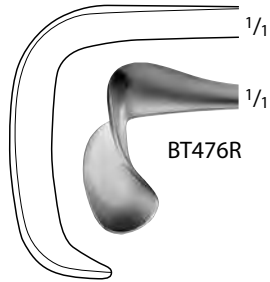

BT476R

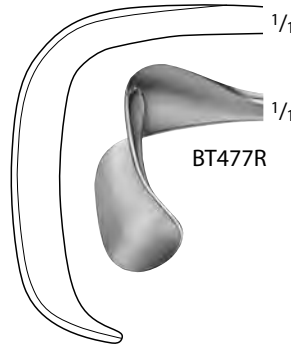

BT477R



BT478R

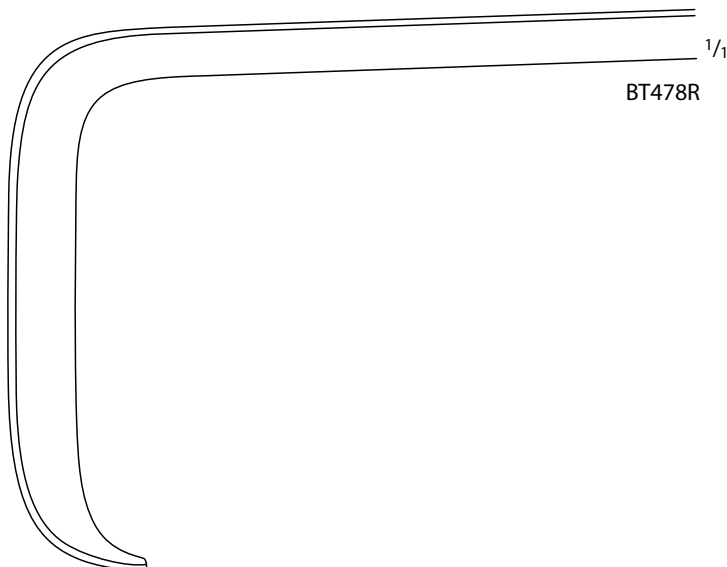

BT478R

RICHARDSON Retractor

Catalog Number	Blade Size (mm)	Blade Size (in.)	Length (in.)
BT479R	65 x 41	2 1/2 x 1 5/8	9 3/4



BT479R



BT479R

KELLY Retractor

Catalog Number	Blade Size (mm)	Blade Size (in.)	Length (in.)
BT481R	50 x 40	2 x 1 1/2	10 1/4
BT482R	64 x 54	2 1/2 x 2	10 1/4
BT483R	70 x 65	2 3/4 x 2 1/2	10 1/4
BT484R	90 x 76	3 1/2 x 3	10 1/4

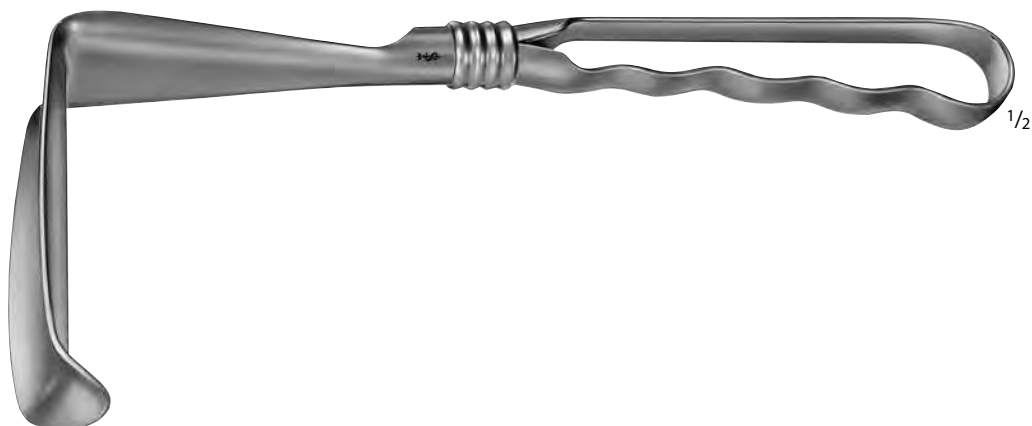

BT481R-BT484R



BT481R

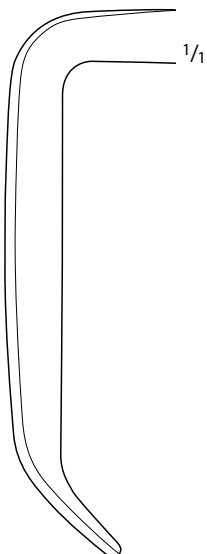

BT482R



BT483R

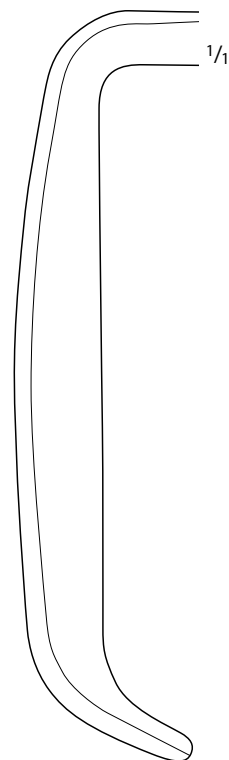

BT484R

SAUERBRUCH Retractor, Open

Catalog Number	Blade Size (mm)	Length (in.)
BT514R	130 x 38	10 1/4

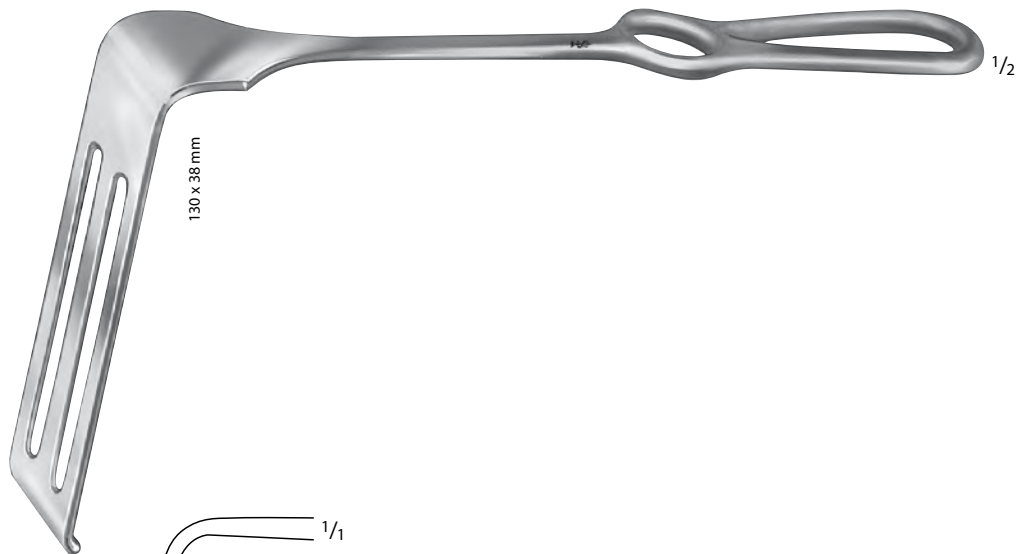

BT514R

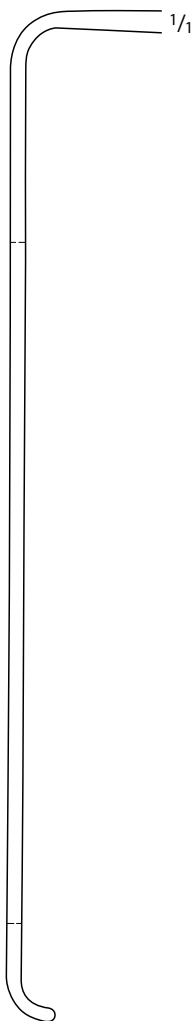

BT514R

HARRINGTON Lung Spatula

Catalog Number	Blade Size (mm)	Blade End	Length (in.)
BT551R	123 x 45	FLEX	11 5/8
BT552R	123 x 64	FLEX	11 5/8
MB930R	190 x 115	FLEX	12 1/2



BT551R, BT552R, MB930R

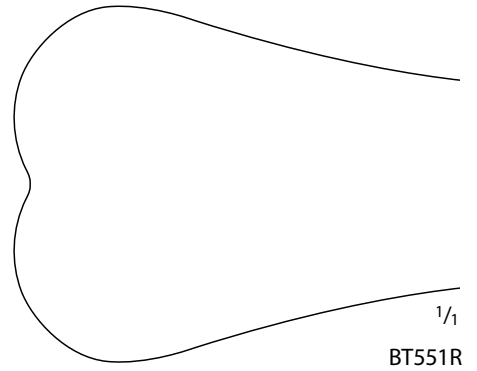

BT551R

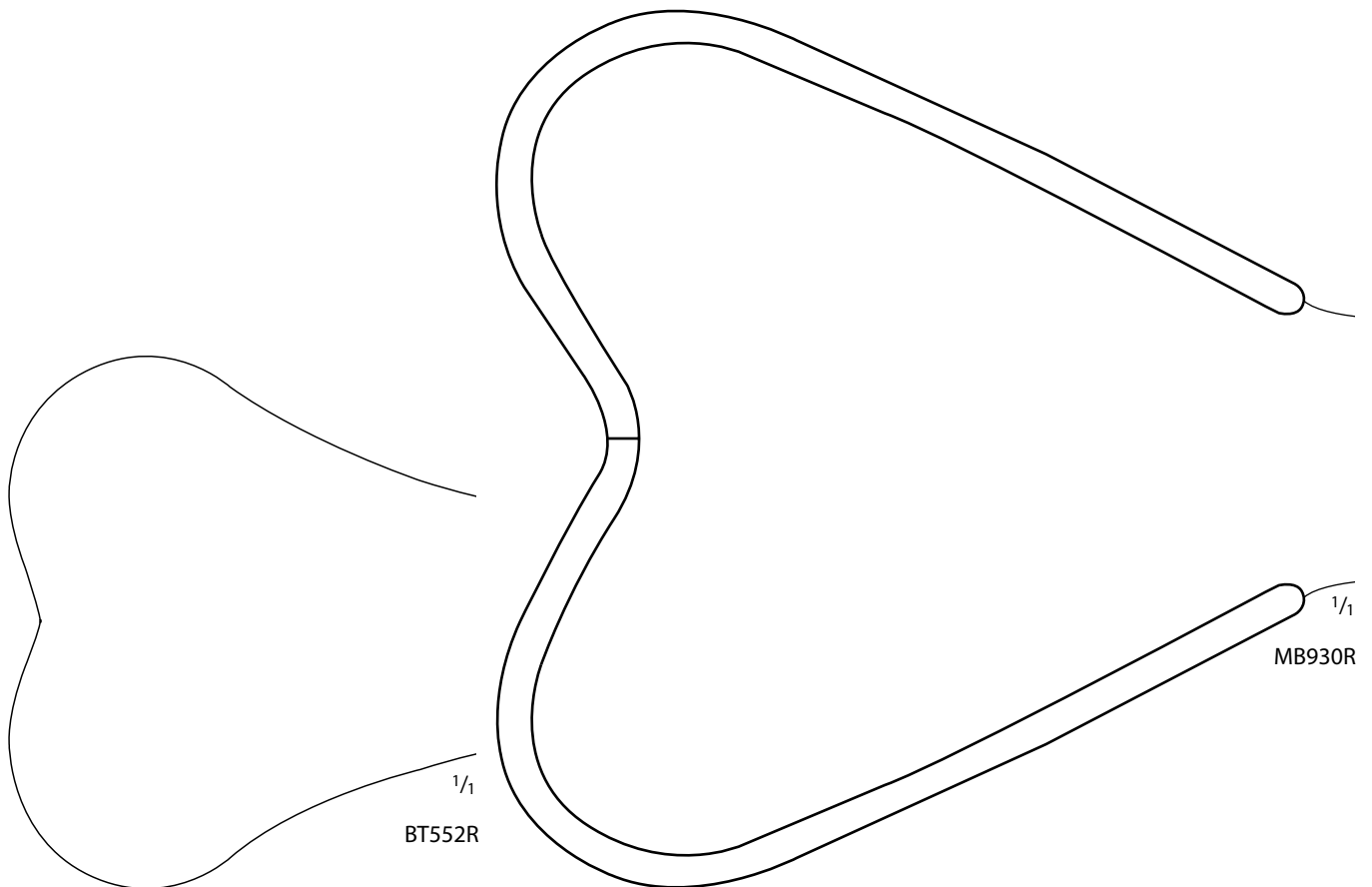

BT552R

MB930R

HARRINGTON Retractor, Large Blade

Catalog Number	Blade Size (mm)	Blade End	Length (in.)
MG472R	195 x 115	FLEX	14 3/8



MG472R

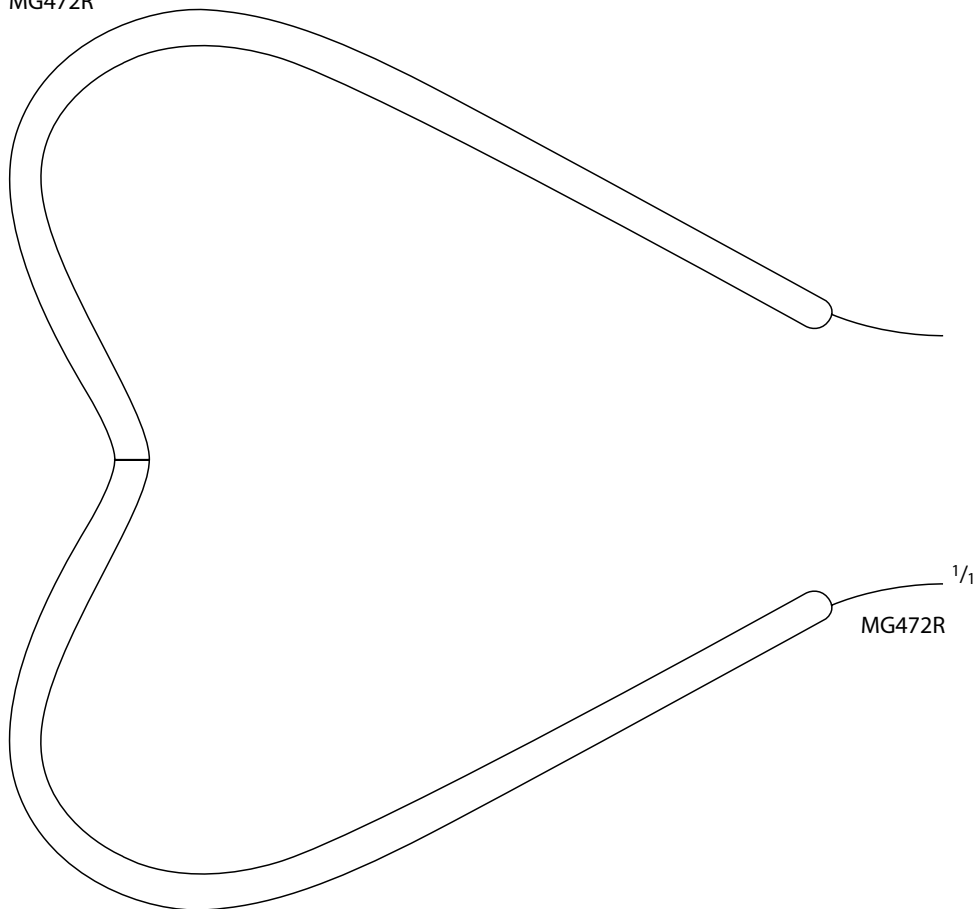

HARRINGTON-PEMBERTON Lung
 Spatula

Catalog Number	Blade Size (mm)	Blade End	Length (in.)
BT553R	175 x 64	FLEX	11 5/8



BT553R

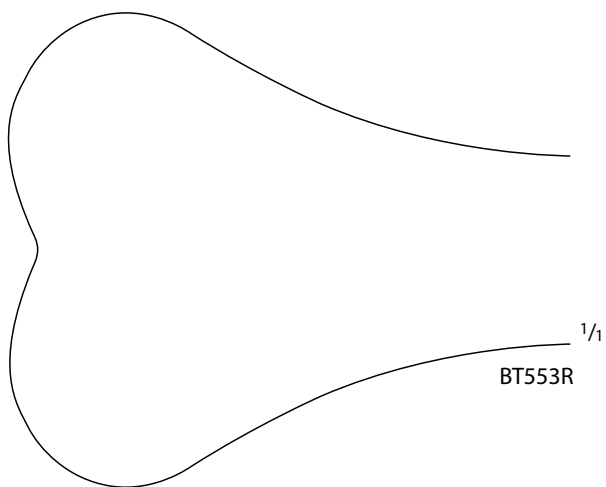

BT553R

ZENKER Retractor

Catalog Number	Blade Size (mm)	Length (in.)
BT594R	36 x 8	9 1/2
BT595R	60 x 12	10
BT596R	75 x 12	10 5/8
BT597R	120 x 12	11 1/2



BT594R-BT597R

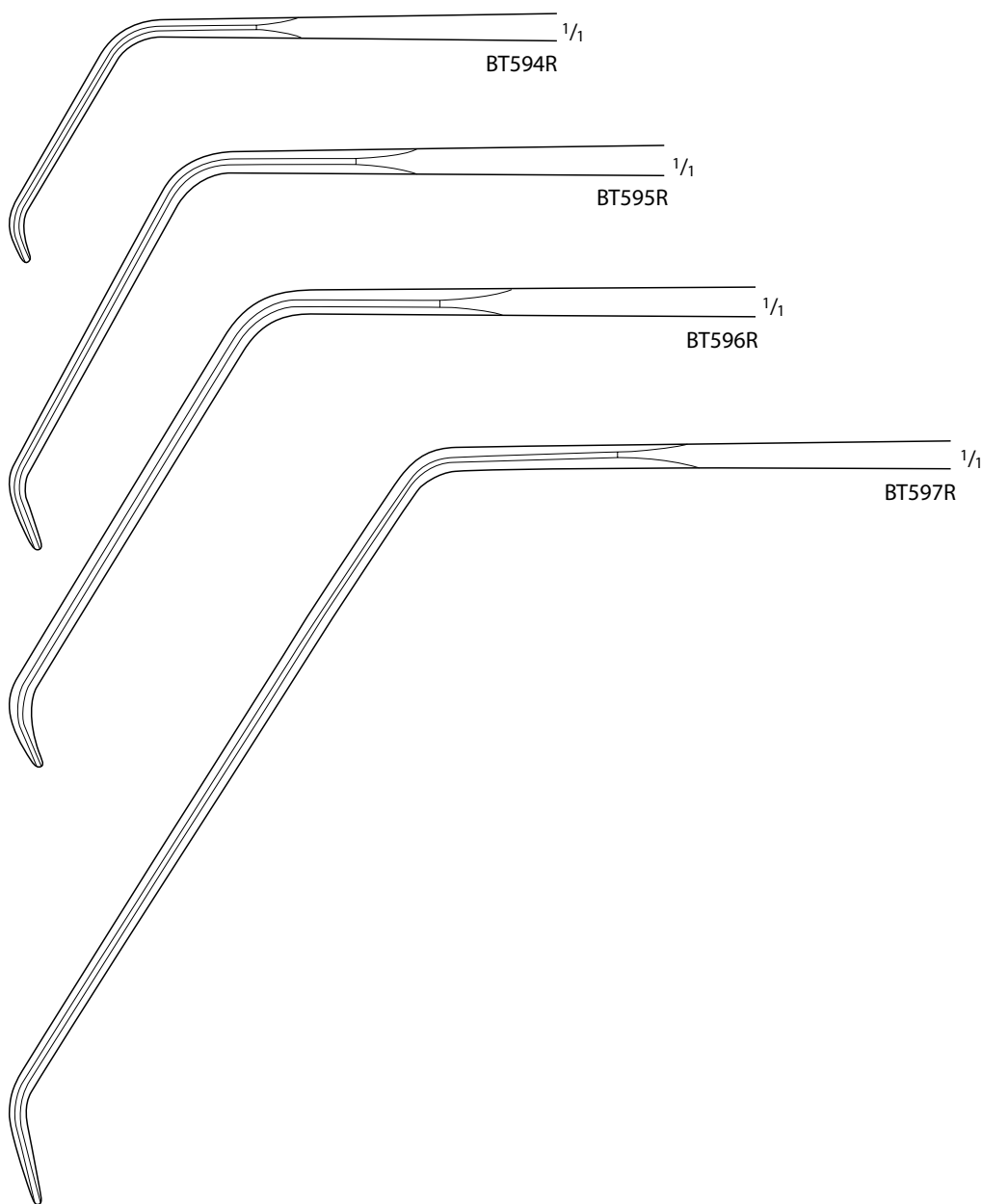



BT600R

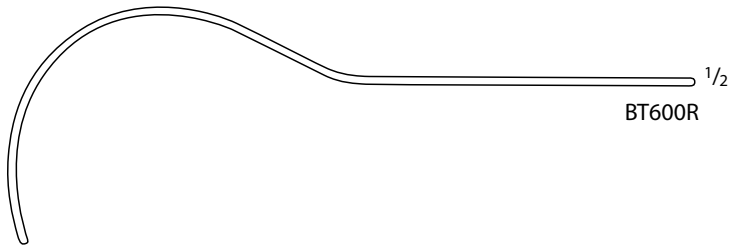

BT600R

DEAVER Retractor

Catalog Number	Blade Size (mm)	Blade Size (in.)	Length (in.)
BT600R	19	3/4	7



BT606R



BT606R

DEAVER Retractor, Double Ended

Catalog Number	Blade Size (mm)	Blade Size (in.)	Length (in.)
BT606R	25	1	9 1/4



BT600R

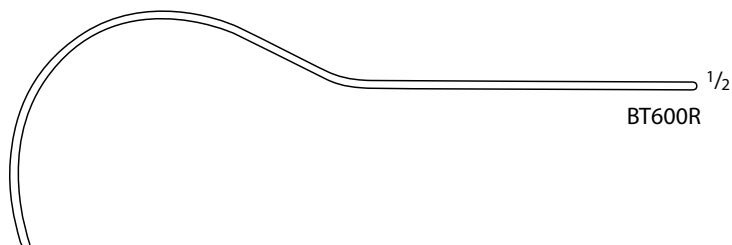

BT600R

DEAVER Retractor

Catalog Number	Blade Size (mm)	Blade Size (in.)	Length (in.)
BT600R	19	3/4	7



BT606R



BT606R

DEAVER Retractor, Double Ended

Catalog Number	Blade Size (mm)	Blade Size (in.)	Length (in.)
BT606R	25	1	9 1/4

DEAVER Retractor

Catalog Number	Blade Size (mm)	Blade Size (in.)	Length (in.)
BT601R	22	7/8	8 1/2
BT602R	25	1	11 3/4
BT603R	25	1	12 3/8



BT601R

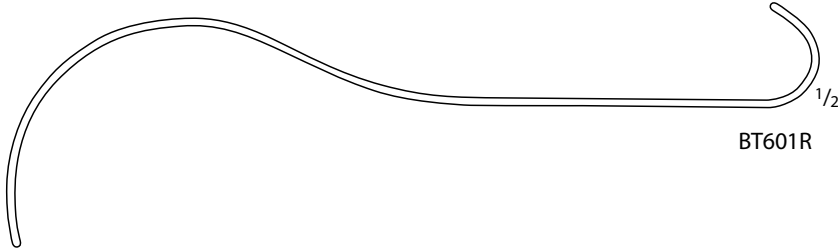

BT601R



BT602R-BT603R

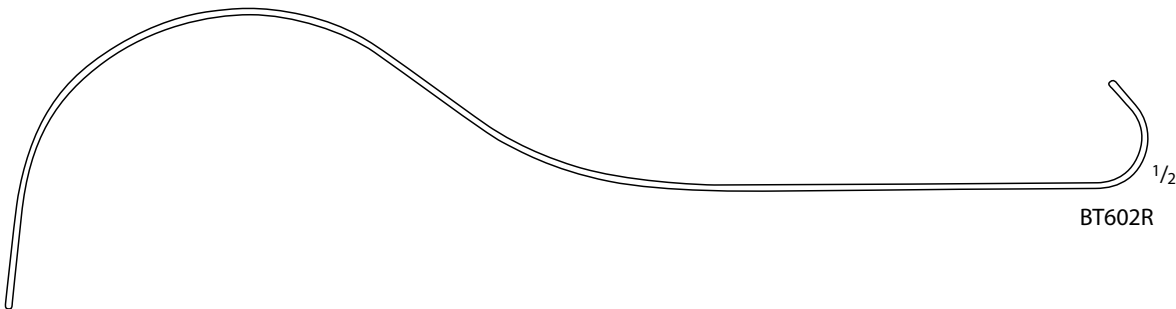

BT602R

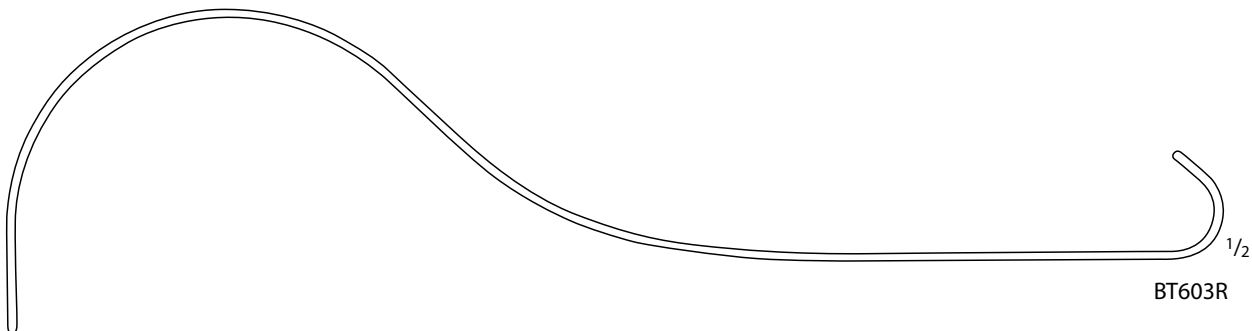

BT603R

DEAVER Retractor
 (continued)

Catalog Number	Blade Size (mm)	Blade Size (in.)	Length (in.)
BT604R	38	1 1/2	11 3/4



BT604R

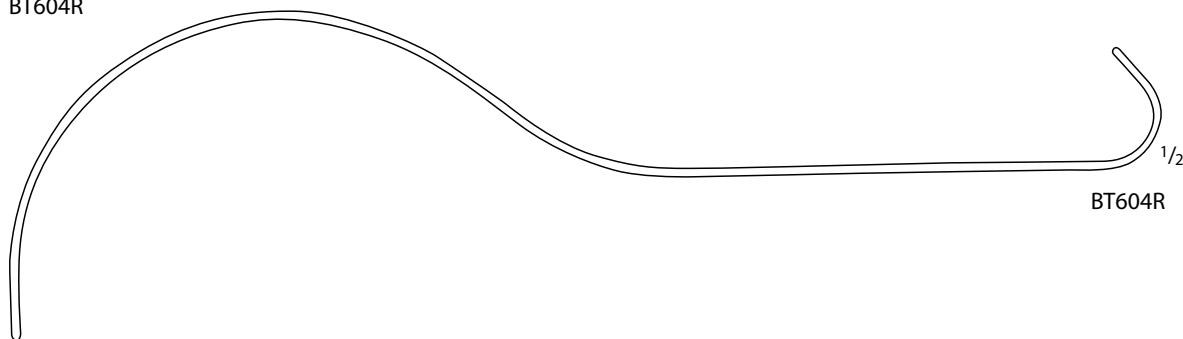

BT604R

DEAVER Retractor
 (continued)

Catalog Number	Blade Size (mm)	Blade Size (in.)	Length (in.)
BT605R	50	2	12 1/4
BT607R	25	1	14 3/8



BT605R-BT607R

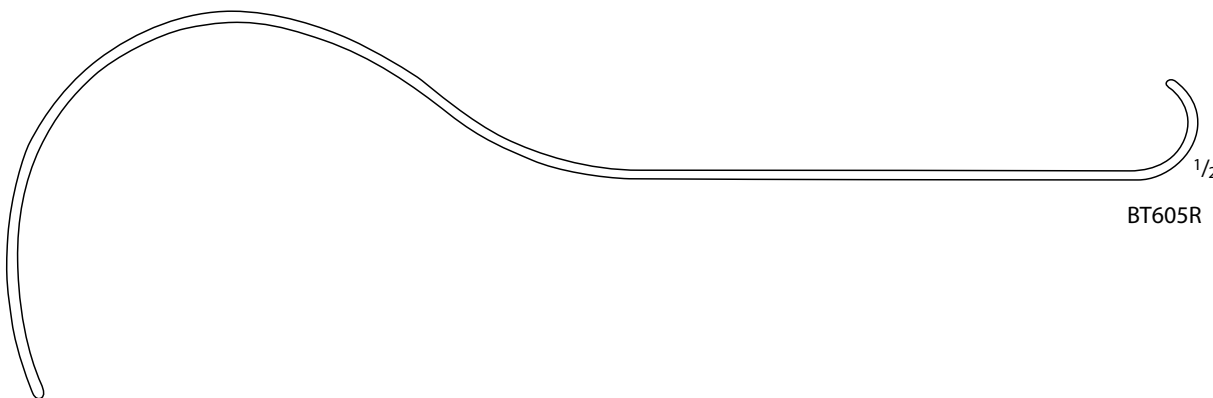

BT605R

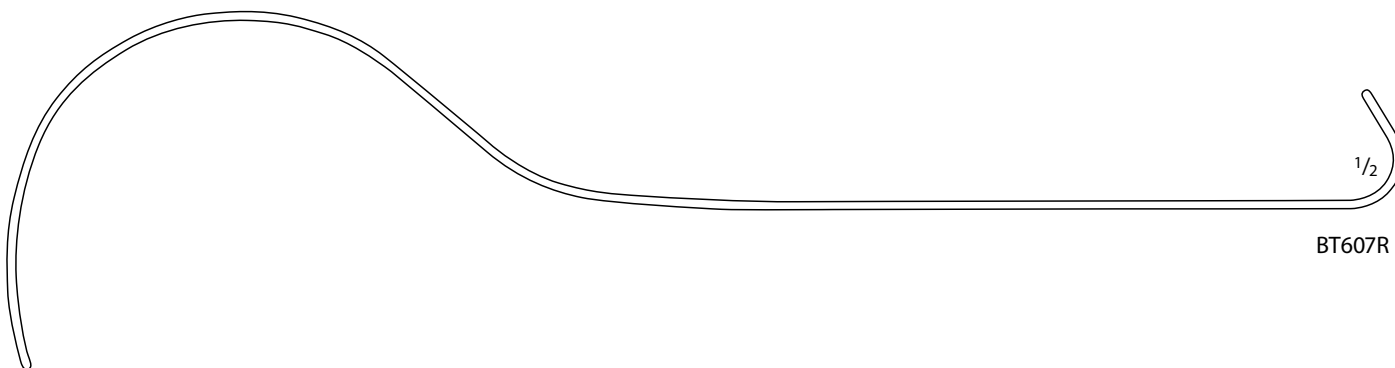

BT607R

DEAVER Retractor
 (continued)

Catalog Number	Blade Size (mm)	Blade Size (in.)	Length (in.)
BT608R	75	3	12 1/2



BT608R

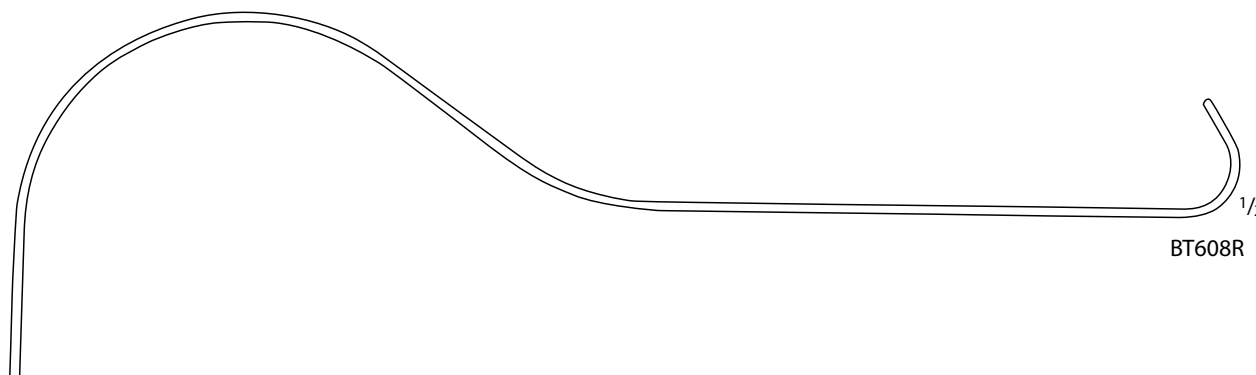

BT608R

DEAVER Retractor, W/ Grip

Catalog Number	Blade Size (mm)	Blade Size (in.)	Length (in.)
BT611R	25	1	12 1/4
BT613R	38	1 1/2	12 1/4
BT614R	50	2	12
BT615R	75	3	12 1/4



BT611R-BT615R

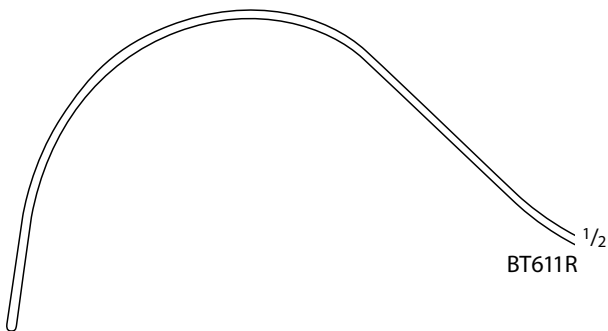

BT611R 1/2

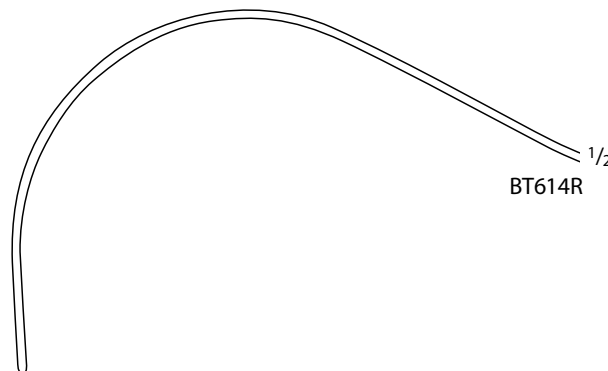

BT614R 1/2

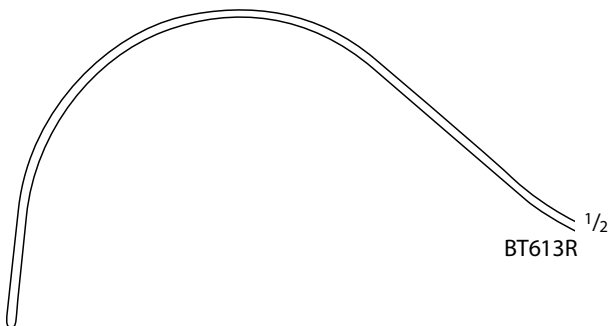

BT613R 1/2

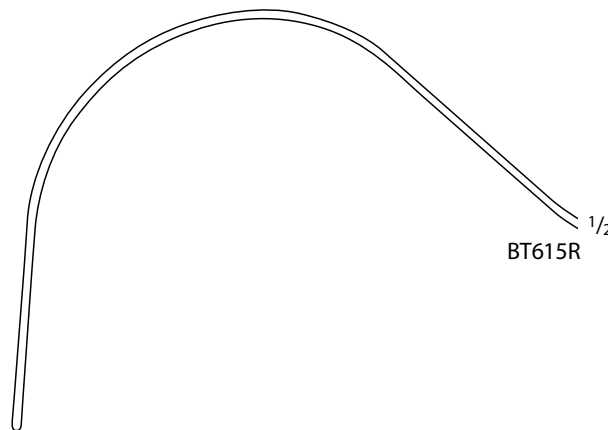

BT615R 1/2



MD071R-MD076

HASSON "S" Retractor, 2/Set

Catalog Number	Blade	Blade Size (mm)	Length (in.)
MD076	MALLEABLE	10	6 1/4
MD077	MALLEABLE	13	7
MD071R	RIGID	10	7 1/8
MD072R	RIGID	13	7 1/8

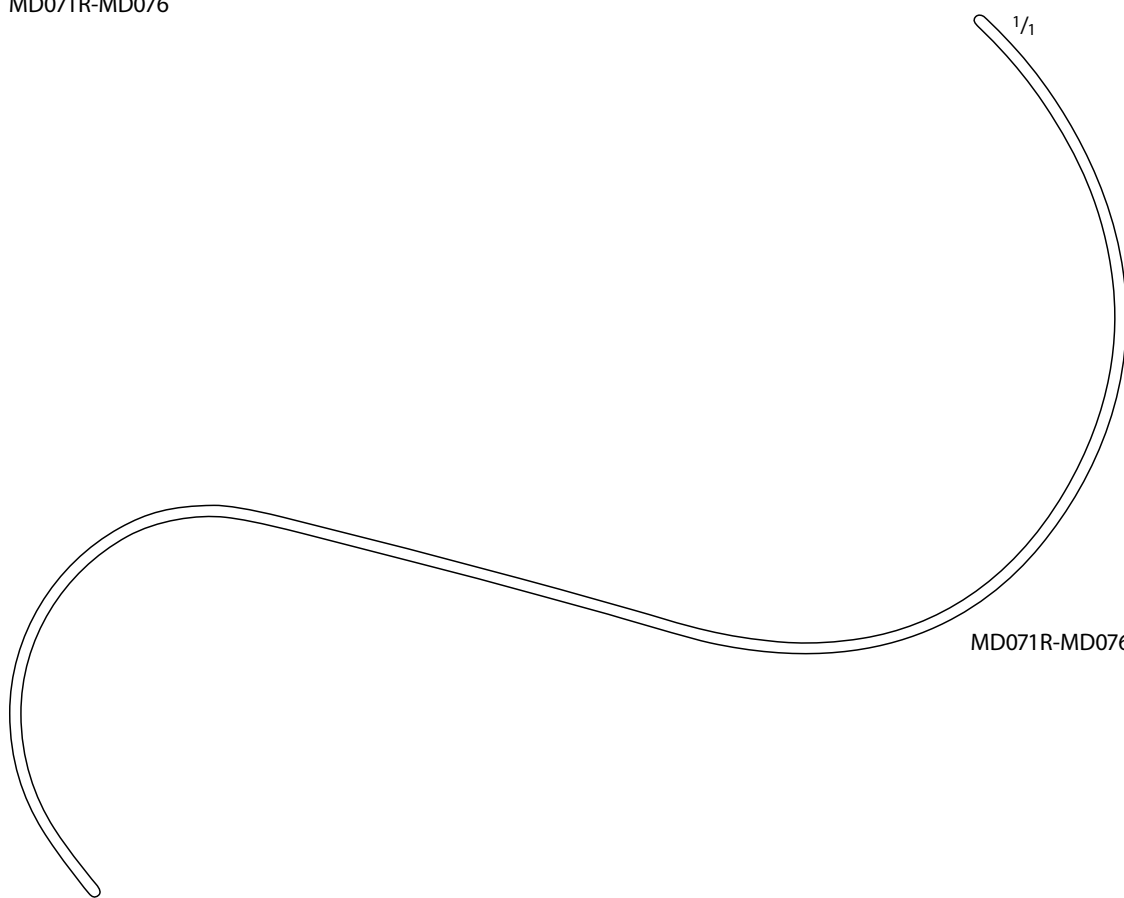

MD071R-MD076



BT750R

TUFFIER Spatula, Malleable

Catalog Number	Blade Size (mm)	Blade Size (in.)	Length (in.)
BT750R	17 / 25	3/4 / 1	7 7/8



BT751R-BT763R, MD498, MG480R-MG484R

Ribbon Spatula, Malleable

Catalog Number	Blade Size (mm)	Blade Size (in.)	Length (in.)
MG480R	5	1/8	8
BT751R	12	1/2	7 7/8
BT752R	17	3/4	7 7/8
MG481R	25	1	8
BT755R	25	1	9 3/4
MD498	75	3	13
MG482R	20	3/4	13
BT756R	25	1	13
BT761R	30	1 1/4	13
BT762R	40	1 1/2	13
BT763R	50	2	13
MG483R	65	2 1/2	13
MG484R	100	4	13



BT758R

HABERER Spatula, Malleable

Catalog Number	Blade Size (mm)	Blade Size (in.)	Length (in.)
BT758R	40 / 50	1 1/2 / 2	12



MG374R

Spatula and Packer, Double Ended

Catalog Number	Length (in.)
MG374R	5 3/4

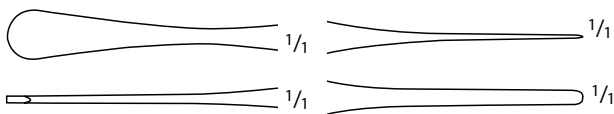

MG374R

DOYEN Abdominal Retractor

Catalog Number	Blade Size (mm)	Length (in.)
BT667R	53 x 80	9 3/4
BT669R	72 x 82	10 1/4



BT667R



BT669R

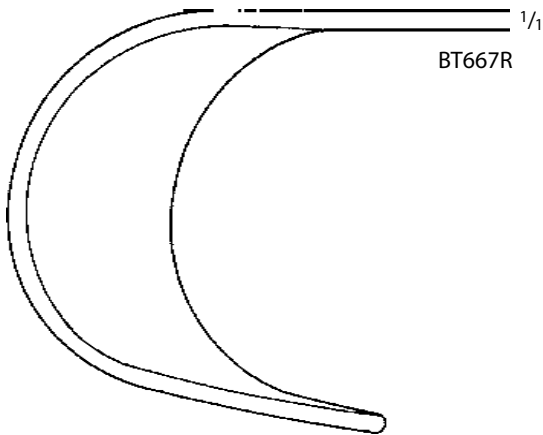

BT667R

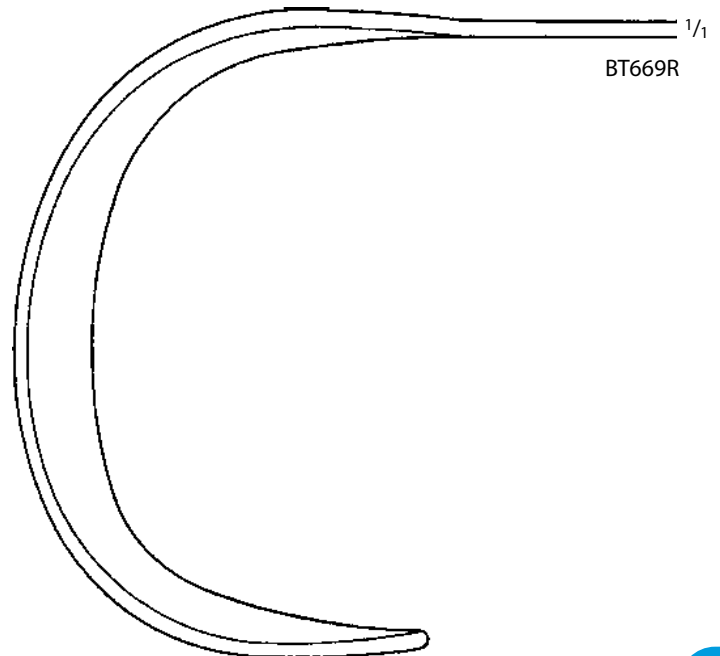

BT669R

WEINBERG Vagotomy Retractor, Joe's
 Hoe

Catalog Number	Blade Size (mm)	Length (in.)
MG491R	47 x 57 / 93 x 157	9



MG491R

ST. MARKS Pelvis Retractor

Catalog Number	Blade Size (mm)	Length (in.)
BT670R	124 x 60	11 1/2
BT672R	174 x 60	13

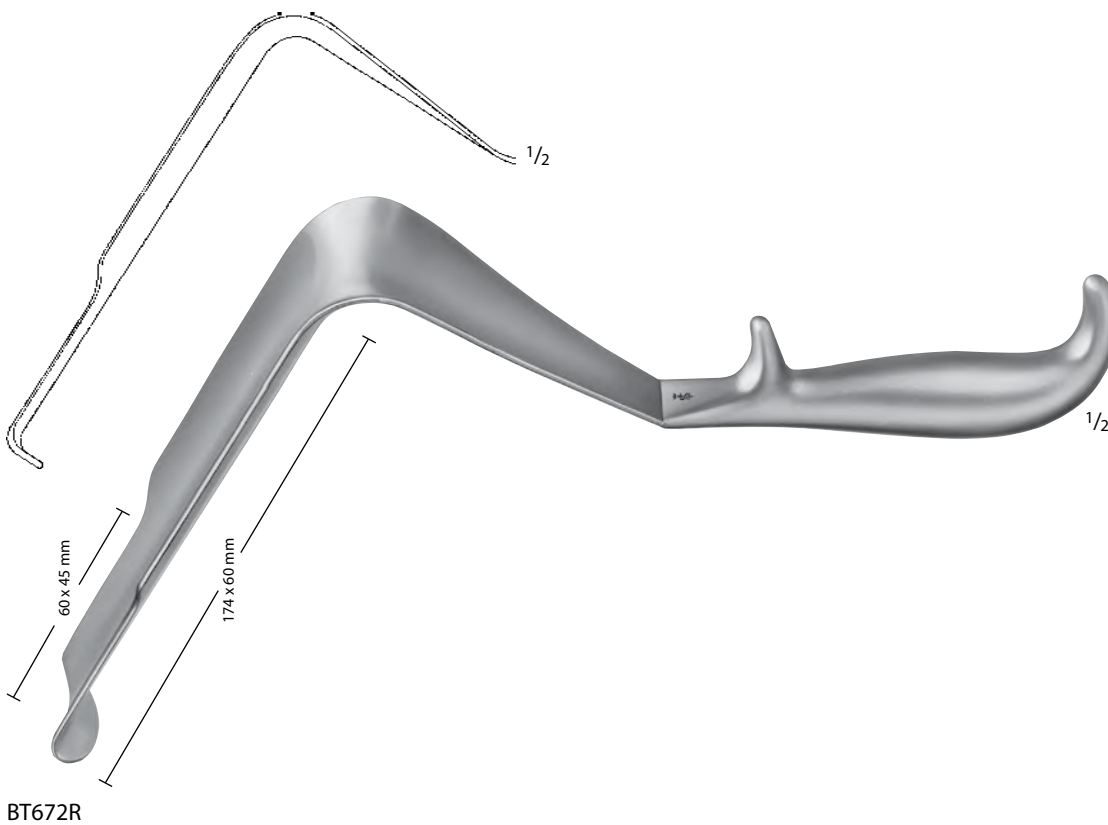
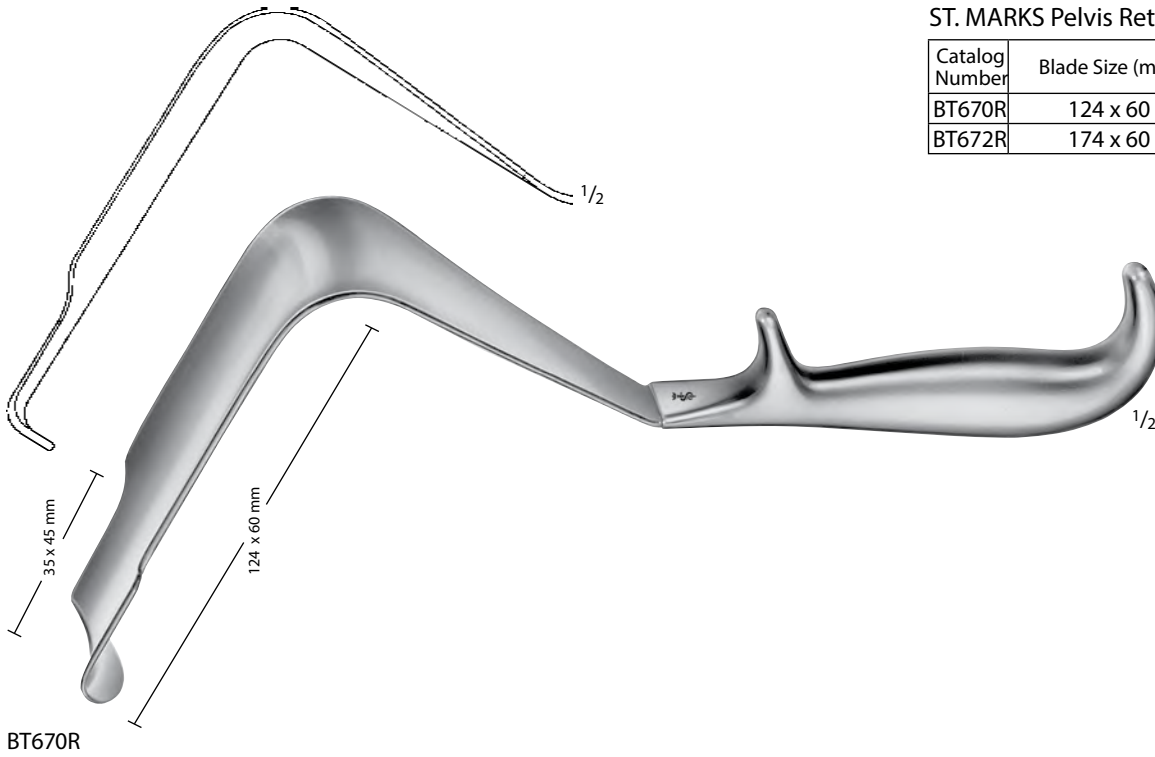

ST. MARKS Pelvis Retractor
 (continued)

Catalog Number	Blade Size (mm)	Length (in.)
BT674R	178 x 60	13

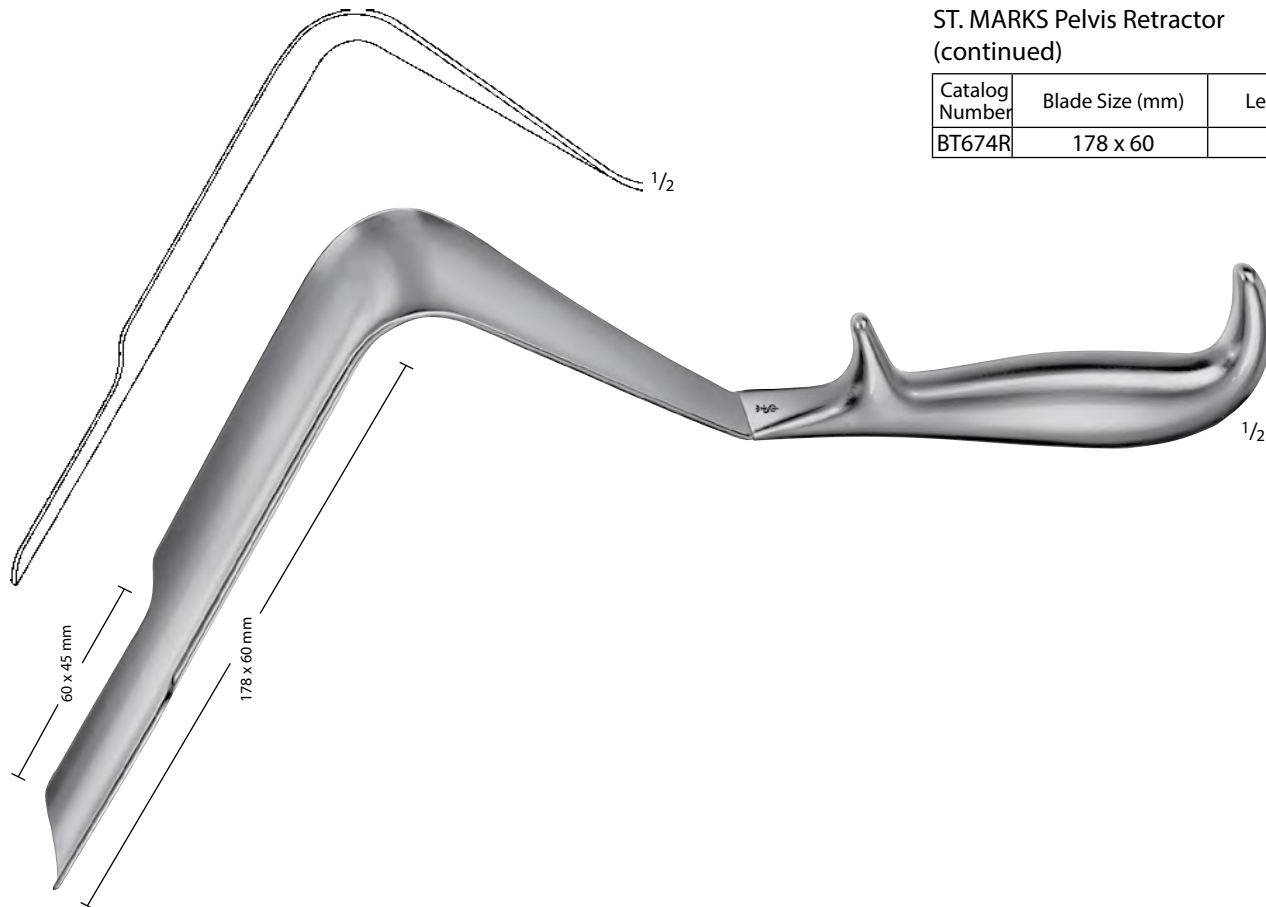

BT674R

MUELLER Retractor

Catalog Number	Blade Size (mm)	Length (in.)
BT626R	250 x 30	10 5/8

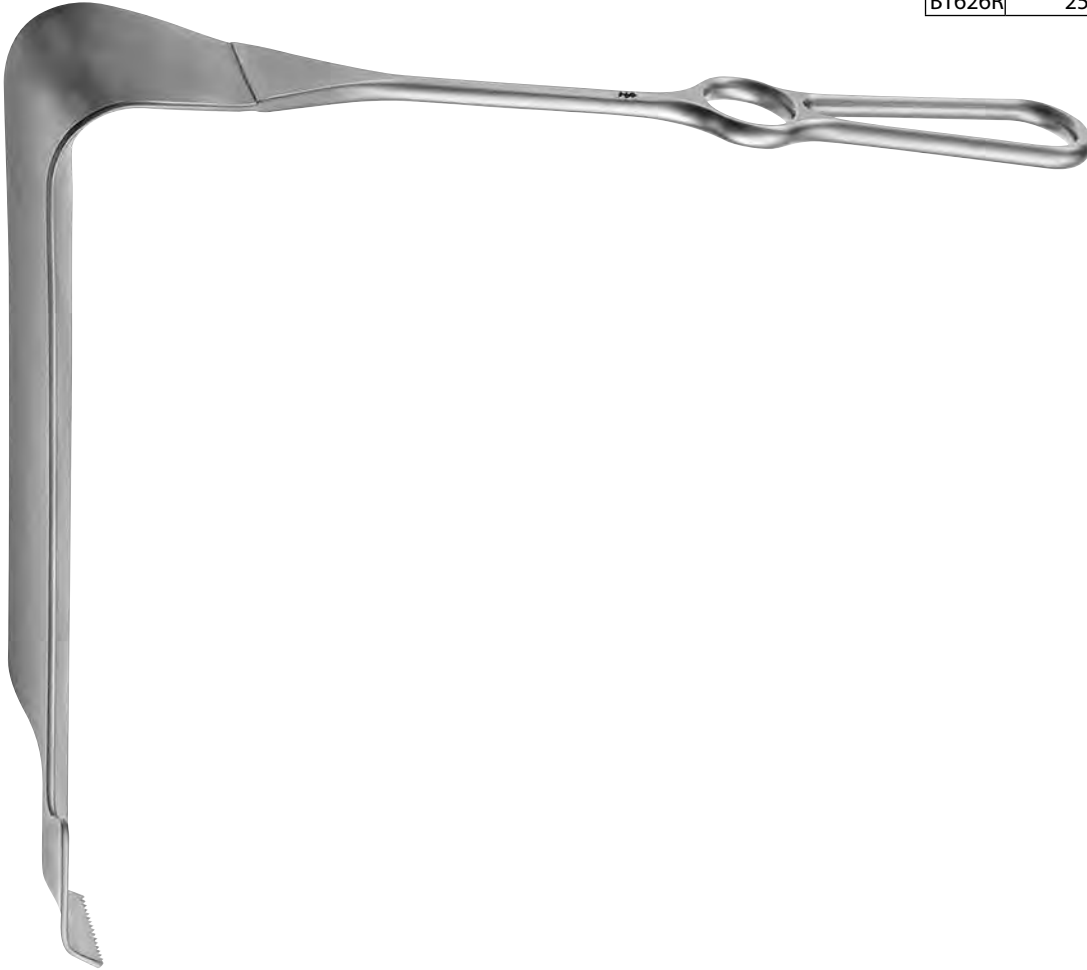

BT626R



MB129R

MAYO-COLLINS Appendectomy
 Retractor

Catalog Number	Length (in.)
MB129R	6 3/4

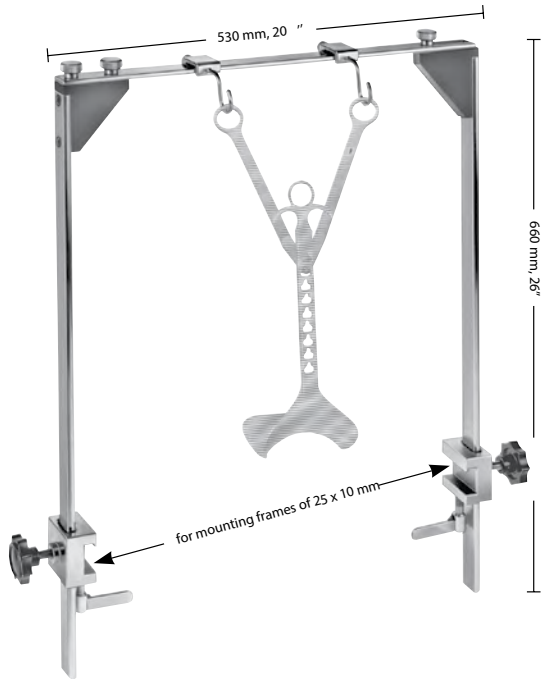

BT708R-BT709R

ROCHARD Retractor Mounting Frame,
 F/ BT711R-BT715R

Catalog Number	Mounting Arms
BT708R	DOUBLE
BT709R	SINGLE

Mounting frame for fastening to the lateral bars of the operating tables, can be dismantled for decontamination and sterilization.

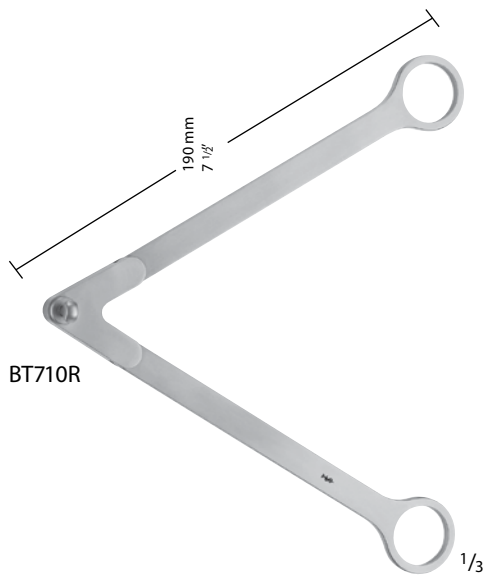

BT710R

ROCHARD Fixation Device,
 F/ BT711R-BT715R

Catalog Number	Length (mm)	Length (in.)
BT710R	190	7 1/2

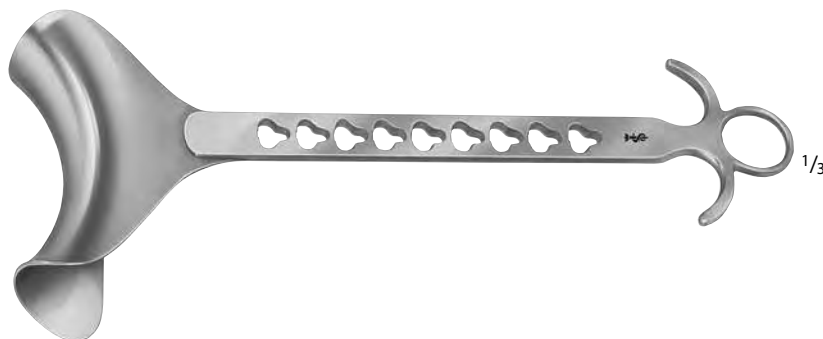

BT711R-BT715R

ROCHARD Blades

Catalog Number	Blade Size (mm)	Length (in.)
BT711R	48 x 90	12 1/4
BT712R	48 x 105	12 1/4
BT713R	48 x 120	12 1/4
BT714R	48 x 135	12 1/4
BT715R	48 x 155	12 1/4

Abdominal Retractor, Malleable,
 W/ Handle

Catalog Number	Blade Size (mm)	Blade Size (in.)	Length (in.)
BT773R	30	1 1/4	16 1/8
BT774R	40	1 1/2	16 1/8
BT775R	50	2	16 1/8
BT776R	60	2 1/2	16 1/8
BT777R	70	2 3/4	16 1/8



BT773R-BT777R

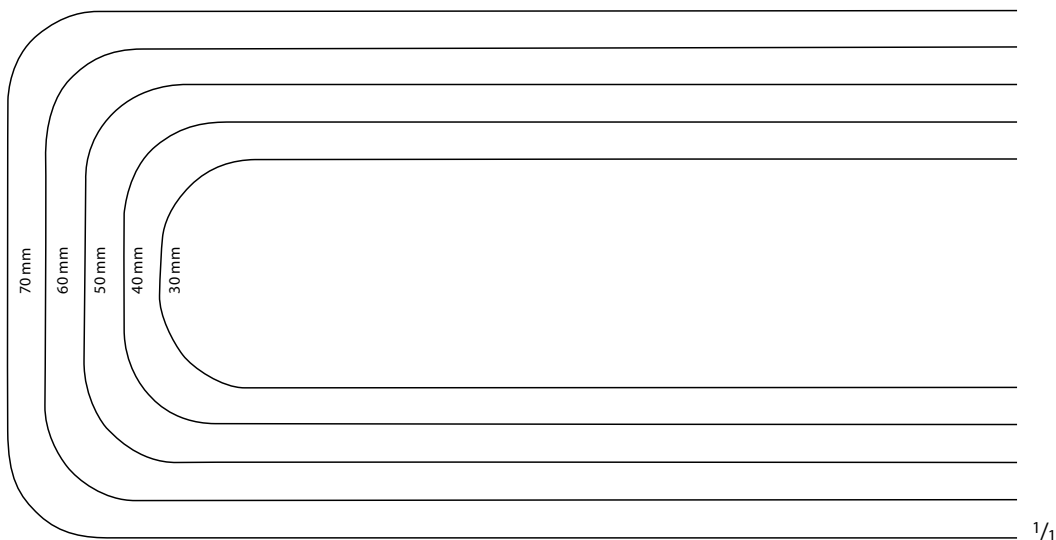

BT773R-BT777R



MB226, MG582R-MG586R

Laparotomy Ring

Catalog Number	Diameter (in.)
MG582R	1 1/2
MG585R	1 3/4
MB226	2
MG586R	3

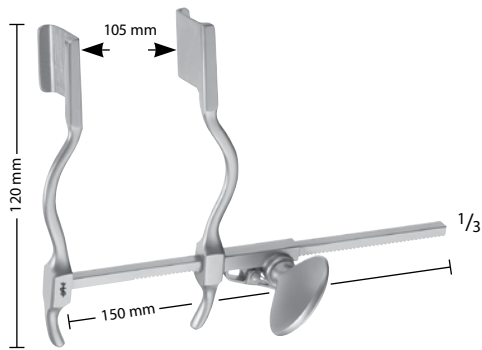

BV512R

HERTZLER Abdominal Retractor

Catalog Number	Blade Size (mm)
BV512R	20 x 25

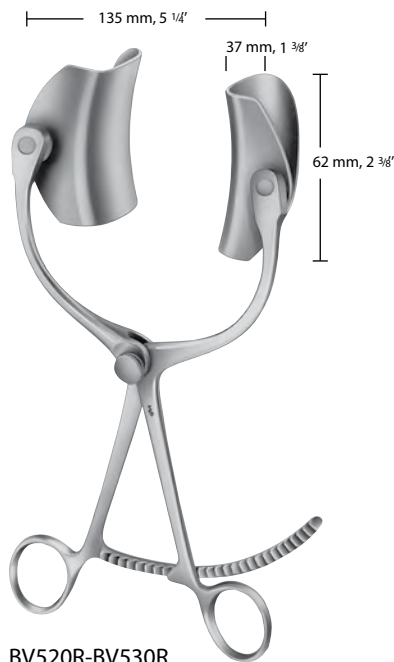

COLLIN Abdominal Retractor W/ Ball Snap Closure

Catalog Number	Description
BV530R	SET COMPLETE
BV520R	SPREADER ONLY
BV551R	LATERAL BLADES, Pair, 37 x 62 MM

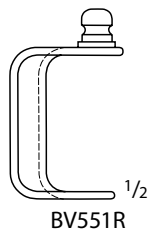

Blade Ejector

Catalog Number	Description	Length (in.)
BV399R	FOR CHANGING BLADES WITH BALL SNAP CLOSURE	4 1/2

GOSSET Abdominal Retractor, Small

Catalog Number	Blade Depth (mm)
BV500R	38

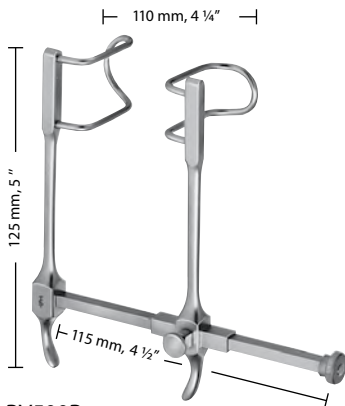

BV500R

GOSSET Abdominal Retractor, Medium

Catalog Number	Blade Depth (mm)
BV502R	55

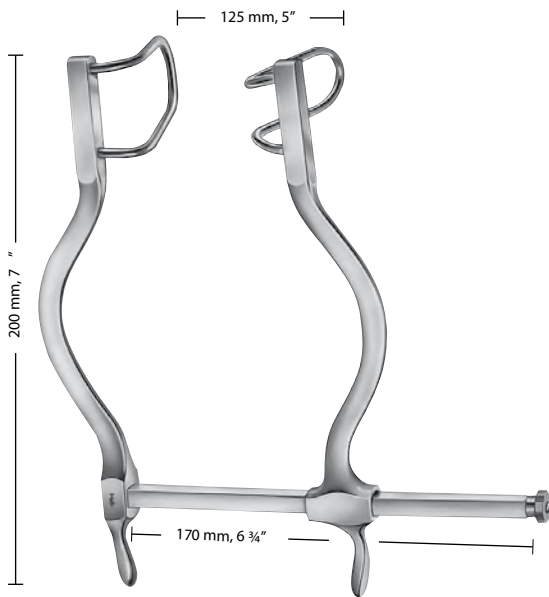

BV502R

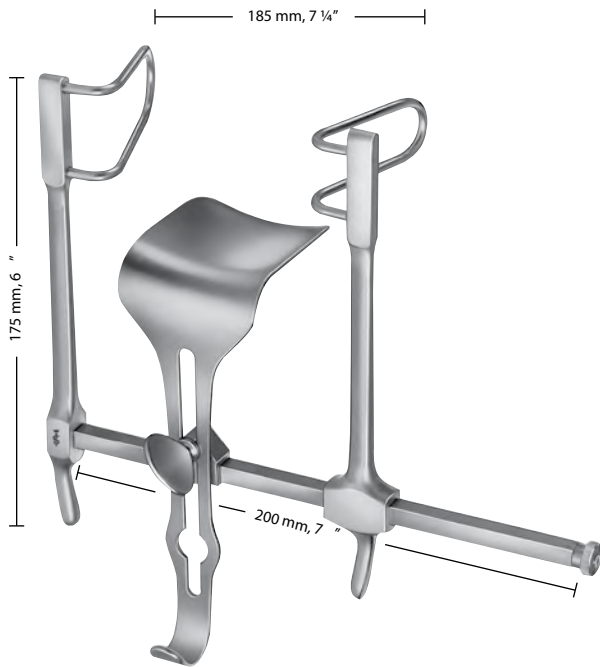

BV505R-BV506R

GOSSET Abdominal Retractor, Large

Catalog Number	Description
BV505R	SET COMPLETE
BV506R	CENTER BLADE ONLY 59 x 57 MM

BV505R Includes:
 1 Center Blade BV506R

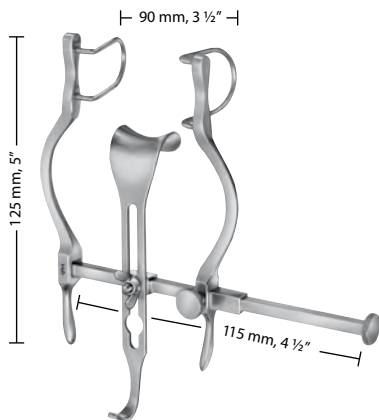

BV601R-BV602R

BALFOUR Baby Abdominal Retractor

Catalog Number	Description
BV601R	SET COMPLETE
BV602R	CENTER BLADE ONLY, 21 x 24 MM

BV601R Includes:
 1 Center Blade BV602R

BALFOUR Abdominal Retractor

Catalog Number	Description	Lateral Blades Depth (mm)
BV605R	BALFOUR RETRACTOR, 200 x 155 MM	60
BV608R	BALFOUR RETRACTOR, 200 x 235 MM	60
BV610R	BALFOUR RETRACTOR, 200 x 265 MM	90
BV606R	CENTER BLADE, 47 x 80 MM	-
BV609R	CENTER BLADE, 62 x 76 MM	-
BV611R	CENTER BLADE, 80 x 80 MM	-

BV605R includes BV606R
 BV608R includes BV609R
 BV610R includes BV611R

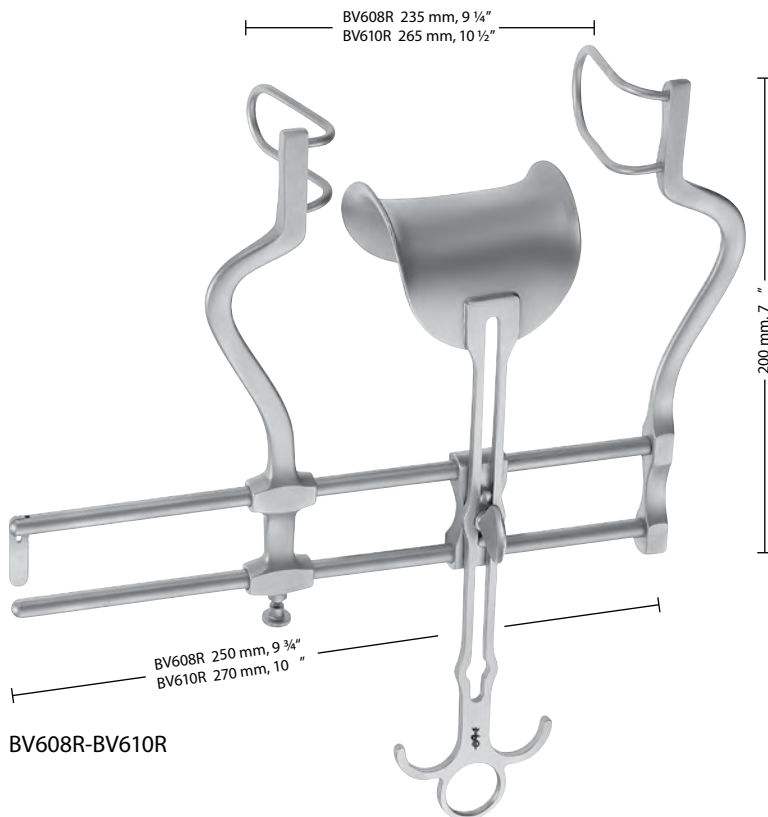
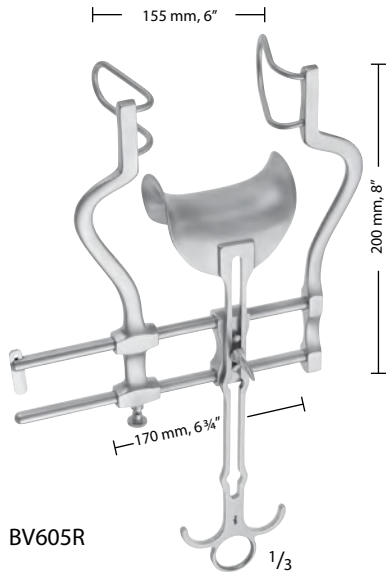

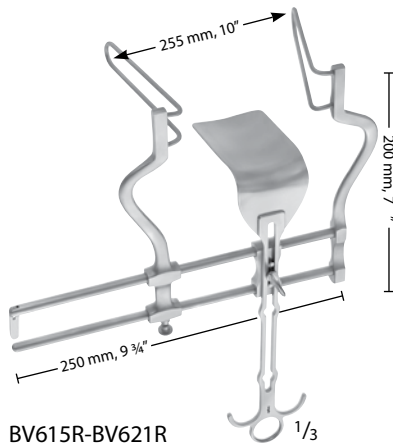

BV615R-BV621R

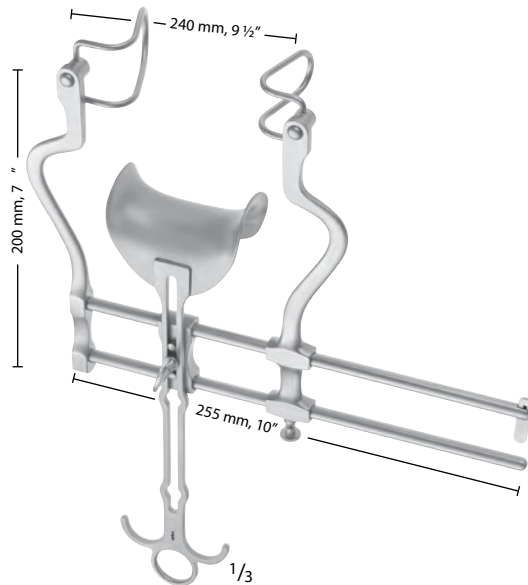

BV632R-BV638R



BV622R-BV628R

BALFOUR Abdominal Retractor
 (continued)

Catalog Number	Description
BV615R	BALFOUR RETRACTOR, 200 x 255 MM COMPLETE W/ BV616R
BV632R	BALFOUR RETRACTOR, COMPLETE W/ BV606R, BV621R, BV622R
BV634R	BALFOUR RETRACTOR, COMPLETE W / BV609R, BV621R, BV624R
BV636R	BALFOUR RETRACTOR, COMPLETE W/ BV611R, BV621R, BV626R
BV638R	BALFOUR RETRACTOR, COMPLETE W/ BV611R, BV621R, BV628R
BV616R	CENTER BLADE, 107 x 59 MM
BV621R	SPREADER ONLY, 200 x 250 MM
BV622R	LATERAL BLADE, PAIR 50 MM
BV624R	LATERAL BLADE, PAIR 60 MM
BV626R	LATERAL BLADE, PAIR 75 MM
BV628R	LATERAL BLADE, PAIR 90 MM



MB637R



MB638R



MB639R



MB577R



MB578R



MB579R

BALFOUR Side Blade Solid
 F/ Retractor MB221R, MB222R

Catalog Number	Description
MB637R	PAIR, 2 1/2" (64 MM) DEEP
MB638R	PAIR, 3 1/2" (89 MM) DEEP
MB639R	PAIR, 4" (102 MM) DEEP

BALFOUR Side Blade Wire
 F/ Retractor MB221R, MB222R

Catalog Number	Description
MB577R	PAIR, 2 1/2" (64 MM) DEEP
MB578R	PAIR, 3 1/2" (89 MM) DEEP
MB579R	PAIR, 4" (102 MM) DEEP

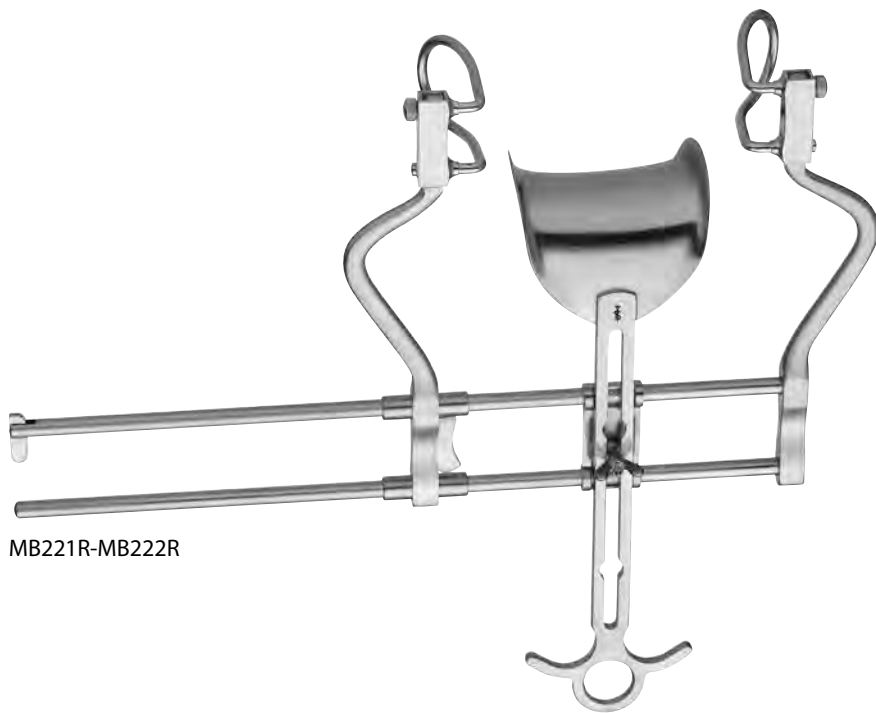

MB221R-MB222R

BALFOUR Retractor W/ Exchangeable Lateral Blades

Catalog Number	Total Width (in.)	Opening Width (in.)	Description
MB221R	16	10 1/2	2 PAIRS OF DETACHABLE BLADES 2 1/2" AND 3 1/2", 1 CENTER BLADE 2 3/4" x 3 1/4"
MB222R	16	8 1/2	2 PAIRS OF DETACHABLE BLADES 2 1/2" AND 3 1/2", 1 CENTER BLADE 2 1/2" x 2 1/2"



MB225

BALFOUR Retractor

Catalog Number	Total Width (in.)	Opening Width (in.)	Description
MB225	13	11	2 LATERAL BLADES 2" x 2" AND 1 1/4" x 2", 1 CENTER BLADE 3" x 10 1/2"

Let Us know if you could not find what you are looking for



MB573R-MB574R

DIXON Center Blade

Catalog Number	Blade	Blade Size (mm)
MB573R	MALLEABLE	171 x 51
MB574R	MALLEABLE	267 x 57



BV617R

BALFOUR Center Blade For All
 BALFOUR Retractors

Catalog Number	Blade Size (mm)
BV617R	54 x 80



BV618R

Center Blade F/ BV615R

Catalog Number	Blade Size (mm)
BV618R	75 x 80

BALFOUR Retractor Extension Arm

Catalog Number	Description	Length (in.)
MG065R	ADULT ABDOMINAL 4" BLADE F/ RIGHT ARM	9 1/2
MG182R	ADULT ABDOMINAL 4" BLADE F/ LEFT ARM	9 1/2



Let Us know if you could not find what you are looking for

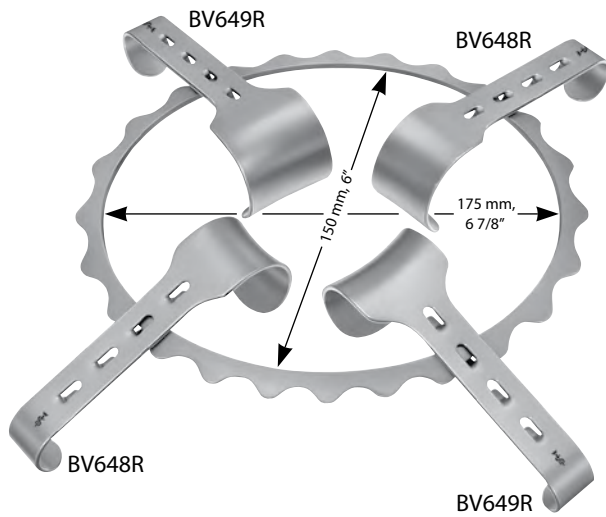

BV646R

DENIS-BROWNE Abdominal Retractor

Catalog Number	Description
BV650R	COMPLETE SET
BV648R	2 BLADES ONLY, 40 x 30 MM
BV649R	2 BLADES ONLY, 40 x 40 MM
BV646R	BLADE ONLY, 20 x 30 MM

BV650R Includes:

1 Frame

2 Blades of each BV648R and BV649R

SEMM Abdominal Retractor

Catalog Number	Description	Blade Size (mm)
BV654R	COMPLETE SET	-
BV653R	FRAME	-
BV655R	2 BLADES	46 x 64
BV656R	BLADE	53 x 54
BV657R	BLADE	82 x 97
BV658R	BLADE </td <td>98 x 51</td>	98 x 51
BV659R	BLADE	107 x 36

BV654R Includes:
 1 Frame BV653R
 1 Blade of each BV656R, BV657R,
 BV658R and BV659R
 2 Blades BV655R

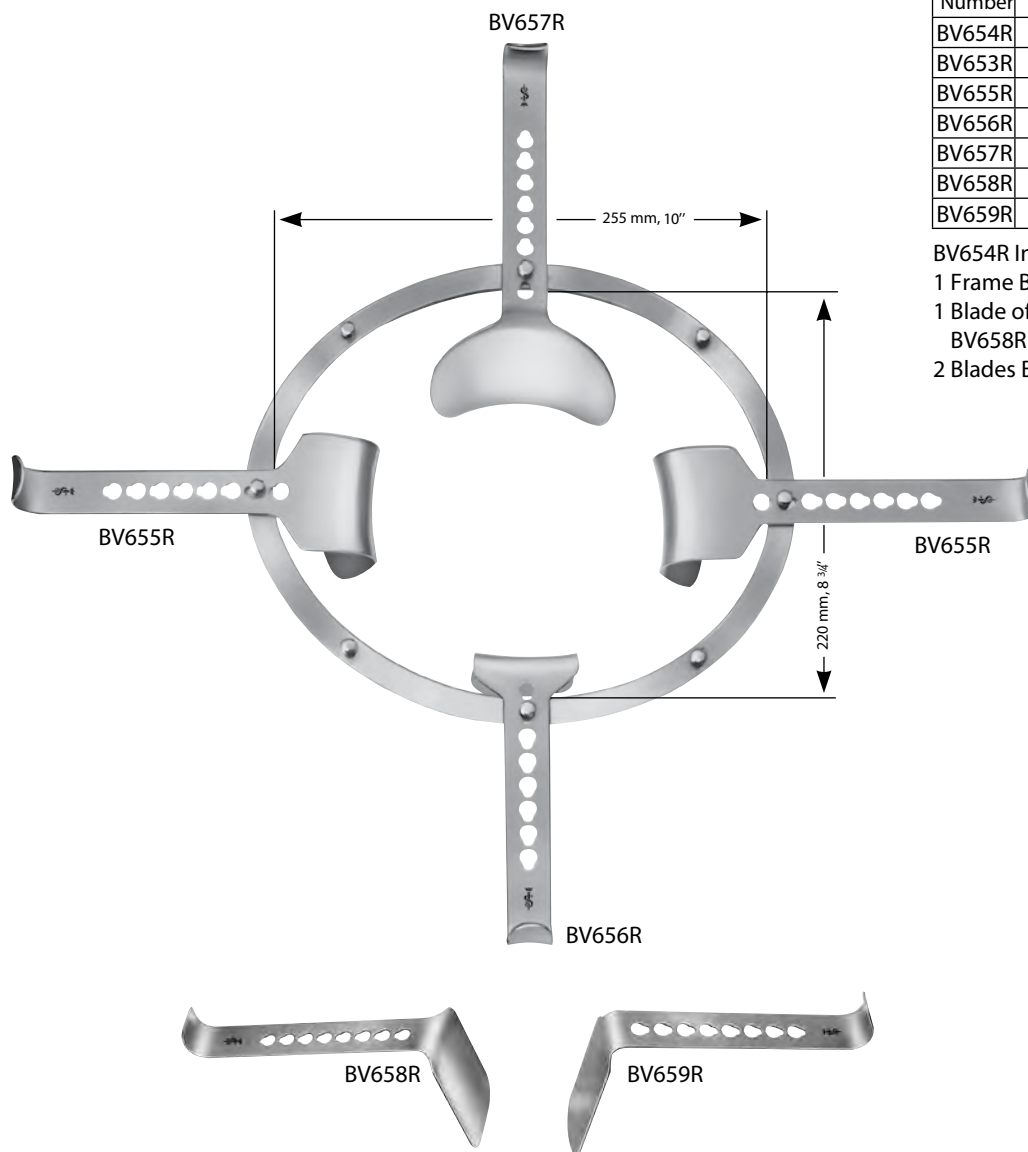



MB499R

Universal Ring Retractor System

Catalog Number	Description
MB499R	COMPLETE SET

Complete System Includes:	
MB497	Segmented Medium Oval Ring
MB516	Medium Oval Ring
MB506	Standard Table Clamp 18"
MB488R	Horizontal Flex Bar w/ 360° Rotation 19 1/4"
MB487R	Horizontal Fixed Bar 15 1/2"
MB504	Post Clamp for 1" Bar
MB503	Non-Tilting Blade Clamp (2 each)
MB510	Tilting Blade Clamp (6 each)
MB524	KELLY Retractor Blade 2" x 3" (2 each)
MB525	KELLY Retractor Blade 2" x 4"
MB526	KELLY Retractor Blade 2" x 5"
MB527	KELLY Retractor Blade 2" x 6"
MB529	Malleable Retractor Blade 1 1/2" x 6"
MB530	Malleable Retractor Blade 2" x 6"
MB532	Malleable Retractor Blade 3" x 6"
MB534	BALFOUR Bladder Blade 3" x 2 1/2"
MB544	HARRINGTON Sweetheart Blade 2 1/2" x 5"
MB546	GELPI Point Retractor Blade



MB515-MB517

Oval Ring

Catalog Number	Size	Width x Length (in.)
MB515	SMALL	8 1/2 x 12
MB516	MEDIUM	10 1/2 x 15
MB517	LARGE	12 1/2 x 18 1/2

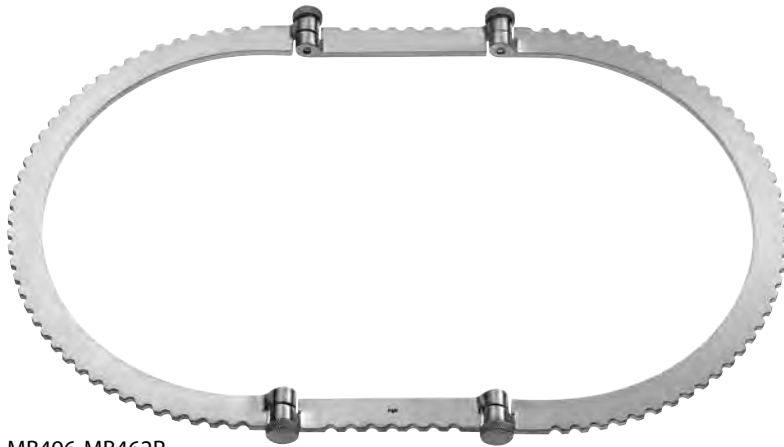

MB496-MB462R



MB471R-MB473R



MB564

Segmented Oval Ring

Catalog Number	Size	Description	Width x Length (in.)
MB496	SMALL	INCLUDES REMOVABLE 4" SEGMENTS	8 1/2 x 14
MB497	MEDIUM	INCLUDES REMOVABLE 8" SEGMENTS	10 1/2 x 19 1/2
MB498	LARGE	INCLUDES REMOVABLE 6" SEGMENTS	12 1/2 x 19 1/2
MB462R	X-LARGE	INCLUDES REMOVABLE 6" SEGMENTS	16 x 22

Segments for Segmented Oval Ring, Pair

Catalog Number	Length (in.)
MB471R	4
MB472R	6
MB473R	8

URRS Segmented Ring Screw

Catalog Number
MB564

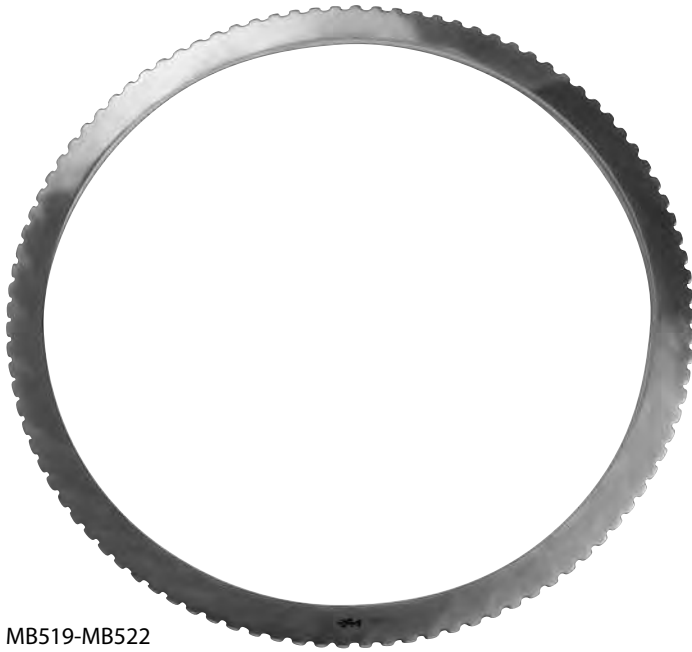

MB519-MB522

Round Ring

Catalog Number	Size	Diameter (in.)
MB519	SET	-
MB520	SMALL	8 1/2
MB521	MEDIUM	10 1/2
MB522	LARGE	12 1/2

MB519 Includes:
 1 Ring of each MB520-MB522

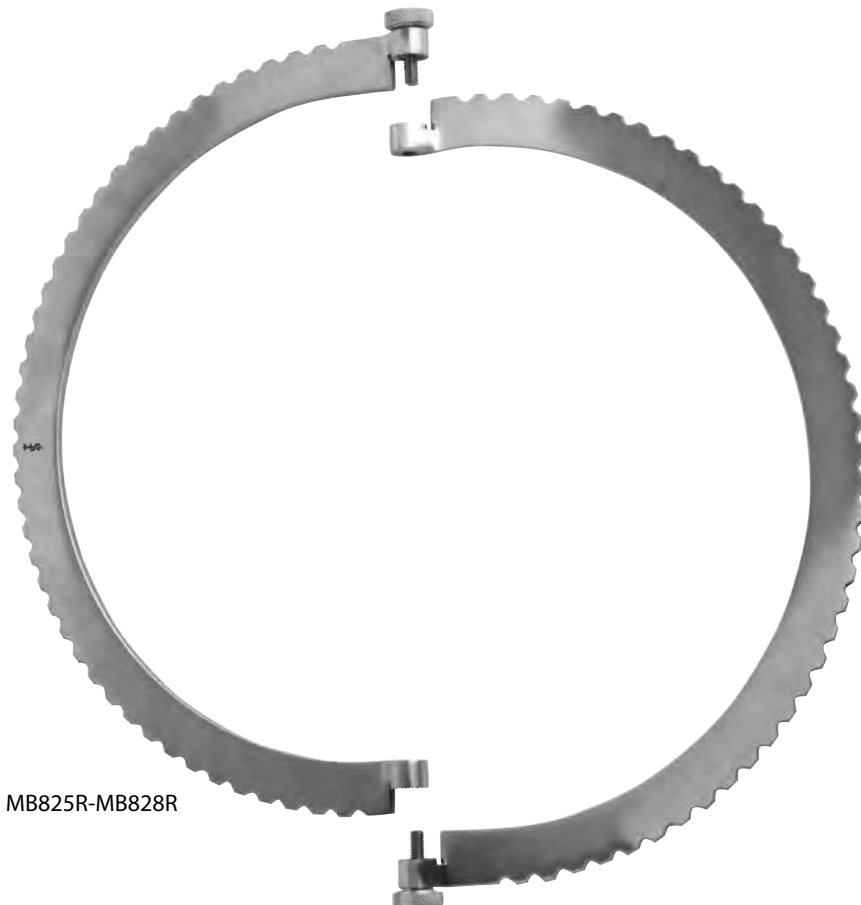

MB825R-MB828R

Segmented Round Ring

Catalog Number	Size	Diameter (in.)
MB825R	SMALL	8 1/2
MB826R	MEDIUM	10 1/2
MB827R	LARGE	12 1/2
MB828R	X-LARGE	16

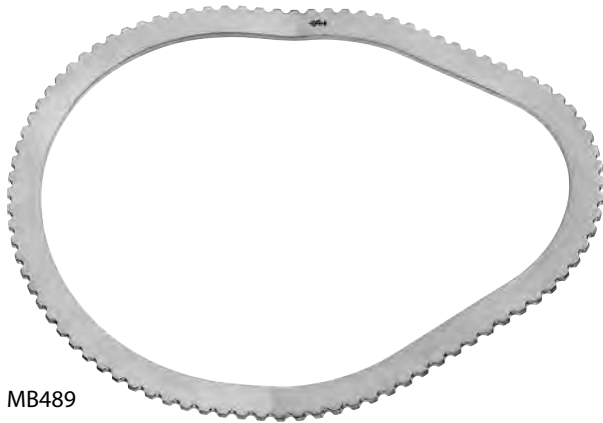

MB489

Vaginal Ring

Catalog Number	Description	Width x Length (in.)
MB489	20° ANGLE	8 x 10 1/2



MG511R

Tilt and Swivel Clamp

Catalog Number
MG511R

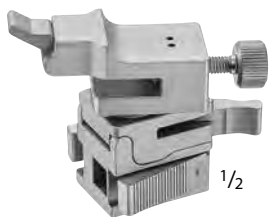

MB973R

Multi Directional Blade Clamp

Catalog Number
MB973R



MB503

Non-Tilting Blade Clamp

Catalog Number
MB503



MB510

Tilting Blade Clamp

Catalog Number
MB510

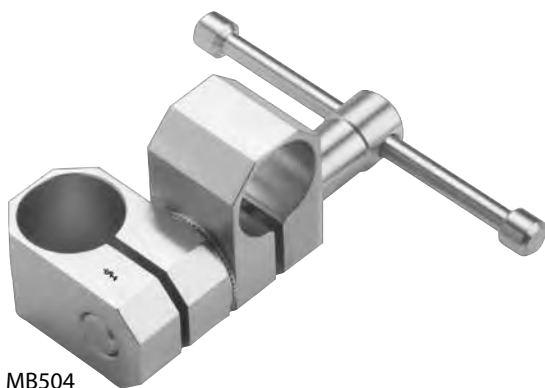

MB504

Post Clamp

Catalog Number
MB504

Table Clamp

Catalog Number	Working Length (in.)	Length (in.)
MB506	15	18
MB460R	21	24



MB460R-MB506

Flat Table Clamp

Catalog Number	Working Length (in.)	Total Length (in.)
MB670R	11 1/2	18
MB821R	17	24



MB670R-MB821R

Horizontal Fixed Bar

Catalog Number	Length (in.)
MB487R	15 1/2
MB823R	22



MB487R-MB823R

Horizontal Flex Bar W/ 360° Rotation

Catalog Number	Length (in.)
MB488R	19
MB824R	22 1/2



MB488R-MB824R

Vertical Extension Bar

Catalog Number	Length (in.)
MB508	12
MB822R	14



MB508-MB822R

Adapter For Attaching Handheld
 Retractors

Catalog Number
MB509



MB509

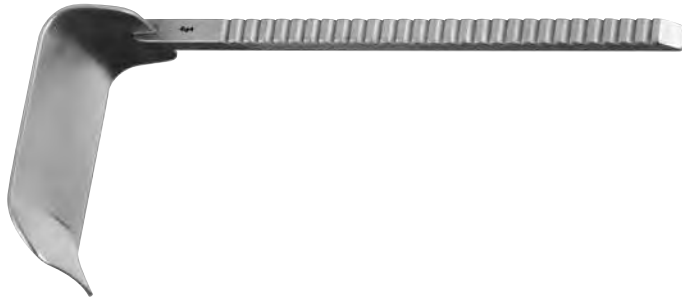

MB469R-MB555

KELLY Retractor Blade

Catalog Number	Description	Width x Depth (in.)
MB555	-	1 x 1 1/2
MB556	-	1 x 2 1/2
MB936R	-	2 x 1 1/2
MB937R	-	2 x 2 1/2
MB524	-	2 x 3
MB525	-	2 x 4
MB526	-	2 x 5
MB527	-	2 x 6
MB469R	BARIATRIC	2 x 8



MB938A-MB943A

Aluminum KELLY Retractor Blade

Catalog Number	Description	Width x Depth (in.)
MB938A	-	2 x 2 1/2
MB939A	-	2 x 3
MB940A	-	2 x 4
MB941A	-	2 x 5
MB942A	-	2 x 6
MB943A	BARIATRIC	2 x 8



MB467R-MB860R

Malleable Retractor Blade

Catalog Number	Description	Width x Depth (in.)
MB860R	-	3/4 x 2
MB861R	-	3/4 x 3
MB862R	-	1 x 1
MB863R	-	1 x 4
MB864R	-	1 x 5
MB865R	-	1 1/2 x 3
MB866R	-	1 1/2 x 4
MB529	-	1 1/2 x 6
MB867R	-	1 1/2 x 8
MB530	-	2 x 6 1/2
MB531	-	2 x 8
MB463R	BARIATRIC	2 x 10
MB532	-	3 x 6
MB464R	BARIATRIC	3 x 10
MB466R	BARIATRIC	3 x 12
MB869R	BARIATRIC	4 x 8
MB465R	BARIATRIC	4 x 10
MB467R	BARIATRIC	4 x 12

Aluminum Malleable Retractor Blade,
 Flat

Catalog Number	Description	Width x Depth (in.)
MB954A	-	1 1/2 x 6
MB955A	-	2 x 6
MB956A	-	2 x 8
MB957A	-	3 x 6
MB958A	BARIATRIC	2 x 10
MB959A	BARIATRIC	3 x 10



MB954A-MB959A



MB557-MB559

RICHARDSON Retractor

Catalog Number	Width x Depth (in.)
MB557	3/4 x 1
MB558	3/4 x 2
MB559	1 x 1 1/4



MB470R-MB534

BALFOUR Bladder Blade

Catalog Number	Description	Width x Depth (in.)
MB534	-	3 x 2 1/2
MB535	-	3 x 3 1/4
MB470R	BARIATRIC	3 x 3 1/2



MB829A-MB830A

Aluminum BALFOUR Bladder Blade

Catalog Number	Width x Depth (in.)
MB829A	2 x 2 3/8
MB830A	3 x 2 1/2



MB968R-MB969R

MAYO Retractor Blade

Catalog Number	Width x Depth (in.)
MB968R	1 1/4 x 1 1/4
MB969R	2 x 2



MB970A

Aluminum MAYO Retractor Blade

Catalog Number	Width x Depth (in.)
MB970A	2 3/4 x 2



MB537-MB539

DEAVER Retractor Blade

Catalog Number	Width x Depth (in.)
MB537	1 x 4 1/2
MB538	1 1/2 x 4 1/2
MB539	2 x 4 1/2



MB492-MB493

DEAVER Vaginal Retractor Blade

Catalog Number	Description	Width x Depth (in.)
MB492	SMALL	1 x 3 1/2
MB493	LARGE	1 x 5



MB490

Vaginal Retractor Posterior Blade

Catalog Number	Width x Depth (in.)
MB490	1 x 4 1/2

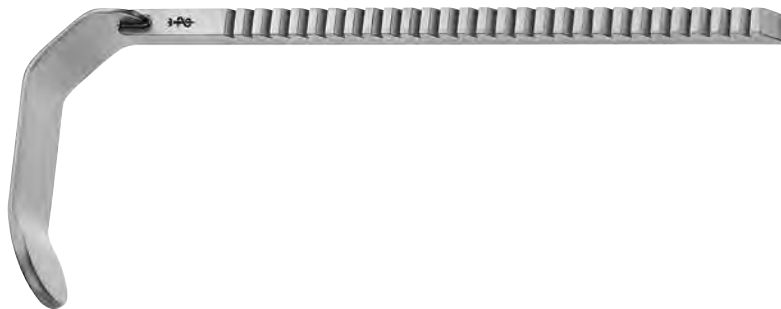

MB491

Vaginal Retractor Lateral Blade

Catalog Number	Width x Depth (in.)
MB491	1 x 3



MB871R

ST. MARK'S Deep Pelvic Retractor
 Blade

Catalog Number	Width x Depth (in.)
MB871R	2 3/8 x 7 1/2



MB494-MB495

Rectal Blade

Catalog Number	Description	Width x Depth (in.)
MB494	SMALL	7/8 x 2 7/8
MB495	LARGE	7/8 x 3 7/8

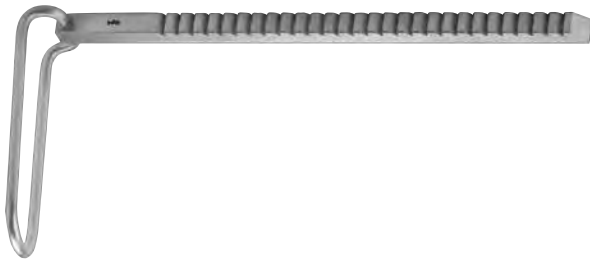

MB541

Skin Incision Blade

Catalog Number	Width x Depth (in.)
MB541	1 1/8 x 3 1/4



MB543-MB832R

HARRINGTON Sweetheart Blade

Catalog Number	Description	Width x Depth (in.)
MB543	-	1 1/2 x 5
MB544	-	2 1/2 x 5 5/8
MB468R	BARIATRIC	3 1/2 x 10
MB832R	BARIATRIC	4 1/2 x 10



MB833A-MB835A

Aluminum HARRINGTON Sweetheart
 Blade

Catalog Number	Description	Width x Depth (in.)
MB833A	-	2 1/2 x 4
MB834A	-	3 1/2 x 8
MB835A	BARIATRIC	3 1/2 x 10



MB546

GELPI Point Retractor Blade

Catalog Number
MB546

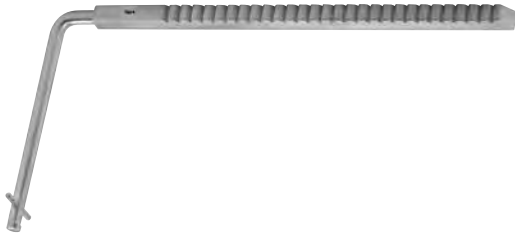

MB548-MB549

SCOVILLE Hook Retractor Blade

Catalog Number	Description	Depth (in.)
MB549	SMALL	2
MB548	LARGE	3 1/4



MB566-MB568

Rake Retractor

Catalog Number	Description	Width x Depth (in.)
MB566	3 PRONGS	2/3 x 3/4
MB567	4 PRONGS	3/4 x 1/3
MB568	6 PRONGS	1 x 1/3



MB551-MB553

MEYERDING Retractor Blade

Catalog Number	Width x Depth (in.)
MB551	1 x 3 1/3
MB552	2 x 3 3/4
MB553	2/3 x 2 1/3



MB962A-MB965A

Aluminum Renal Retractor Blade

Catalog Number	Width x Depth (in.)
MB962A	1 x 4
MB963A	1 x 6
MB964A	1 x 8
MB965A	1 x 10



MB966A-MB967A

Aluminum Splanchnic Retractor Blade

Catalog Number	Width x Depth (in.)
MB966A	2 x 10
MB967A	3 x 8

Perforated Super Malleable Retractor
 Blade

Catalog Number	Width x Depth (in.)
MB960R	2 x 9
MB961R	3 x 9



MB960R-MB961R

YU-HOLTGREWE Malleable Retractor
 Blade

Catalog Number	Width x Depth (in.)
MB870R	2 1/2 x 6



MB870R



BV001R

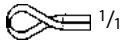

BV001R



BV002R



BV002R



BV003R

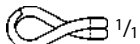

BV003R



BV005R



BV005R

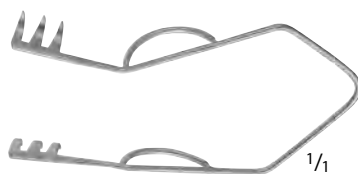

BV014R

FINSEN Retractor

Catalog Number	Tip	Blade End	Length (in.)
BV001R	SHARP	2 x 3 PRONGS	2

FINSEN Retractor

Catalog Number	Tip	Blade End	Length (in.)
BV002R	SHARP	3 x 4 PRONGS	2 3/4

FINSEN Modified Retractor

Catalog Number	Tip	Blade End	Length (in.)
BV003R	BLUNT	2 x 3 PRONGS	3

FINSEN Retractor

Catalog Number	Tip	Blade End	Length (in.)
BV005R	SHARP	3 x 4 PRONGS	2 3/4

PARSONNET Epicardial Retractor

Catalog Number	Tip	Blade End	Length (in.)
BV014R	SHARP	3 x 3 PRONGS	2



BV006R-BV007R



BV006R



BV007R

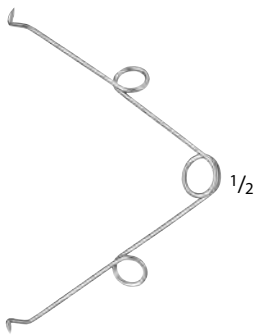

MD471

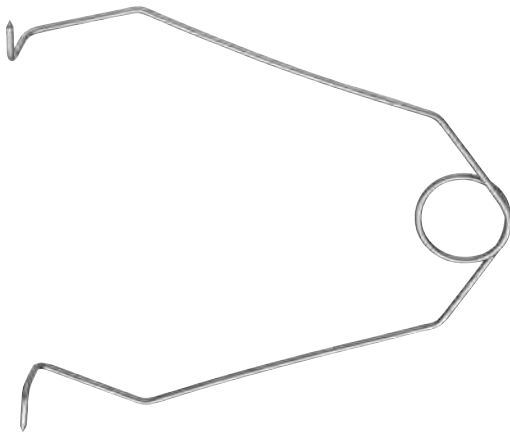

MB196R-MB777R

Spring Wire Retractor

Catalog Number	Tip	Prongs	Length (in.)
BV006R	BLUNT	3 x 3	1 3/4
BV007R	BLUNT	3 x 3	2 1/4
MD471	SHARP	1 x 1	3

Spring Wire Retractor

Catalog Number	Size	Length (in.)
MB777R	SMALL	5
MB778R	MEDIUM	5 1/8
MB196R	LARGE	9



BV010R-BV011R



BV010R



BV011R

ALM Retractor

Catalog Number	Tip	Blade End	Length (in.)
BV010R	SHARP	4 x 4 PRONGS	2 3/4
BV011R	SHARP	4 x 4 PRONGS	4



BV008R-BV015R



BV008R



BV015R

HEISS Self-Retaining Retractor

Catalog Number	Tip	Blade End	Length (in.)
BV015R	SHARP	4 x 4 PRONGS	4
BV008R	BLUNT	4 x 4 PRONGS	4

WEITLANER Retractor

Catalog Number	Tip	Blade End	Length (in.)
BV073R	BLUNT	2 x 3 PRONGS	4 1/4
MA438R	BLUNT	3 x 3 PRONGS	4 1/4
BV074R	BLUNT	3 x 4 PRONGS	5 1/8
BV075R	BLUNT	3 x 4 PRONGS	6 1/2
BV104R	BLUNT/DEEP	3 x 4 PRONGS	5 1/8



BV073R 1/2



MA438R



BV074R

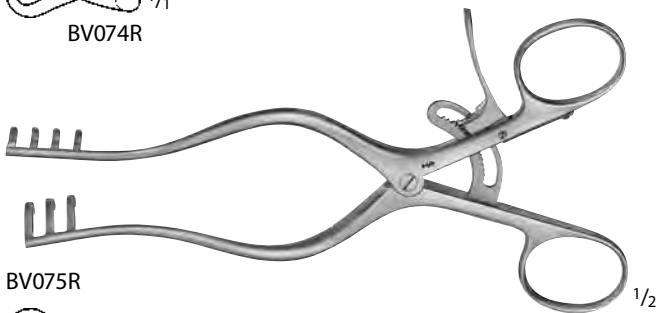
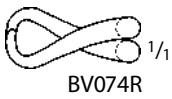

BV075R

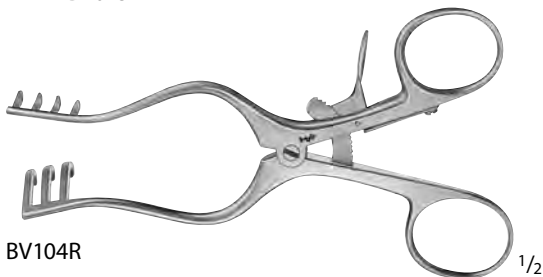
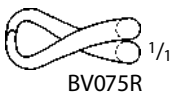

BV104R

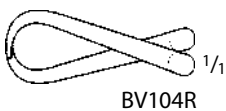

BV104R

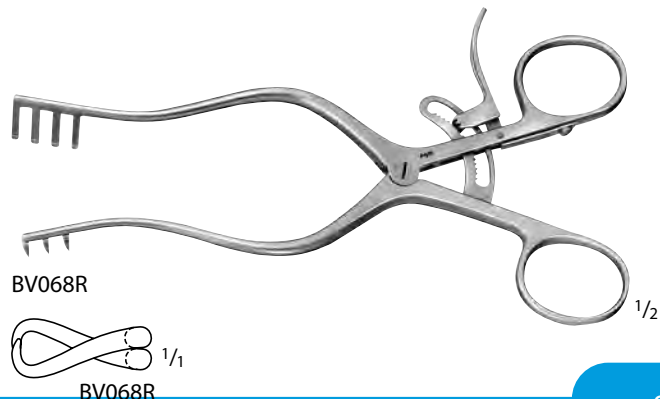
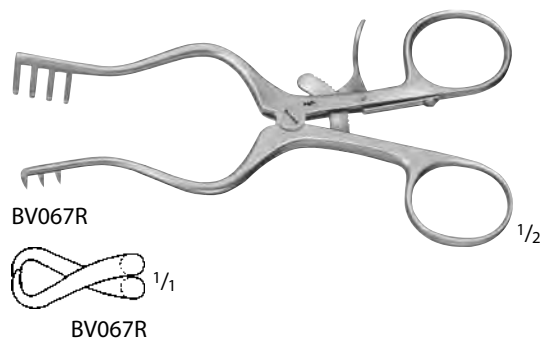
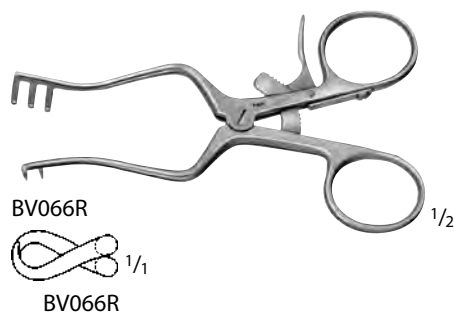
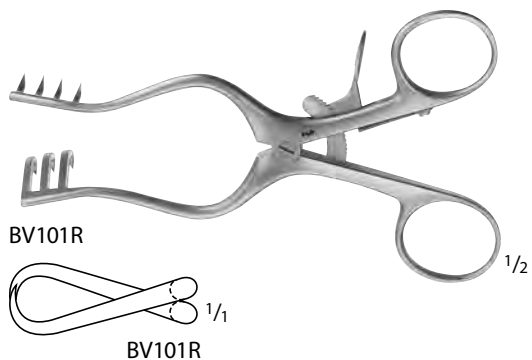
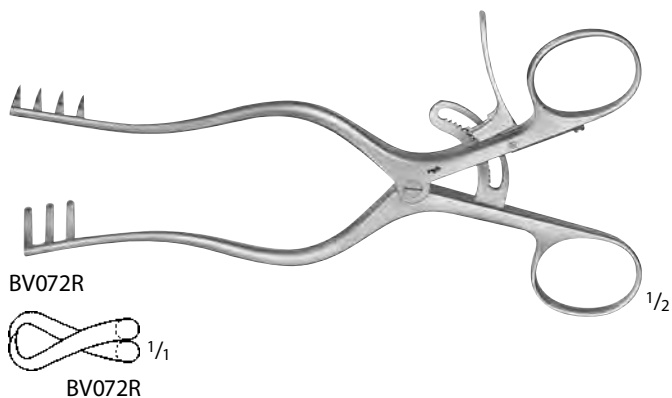
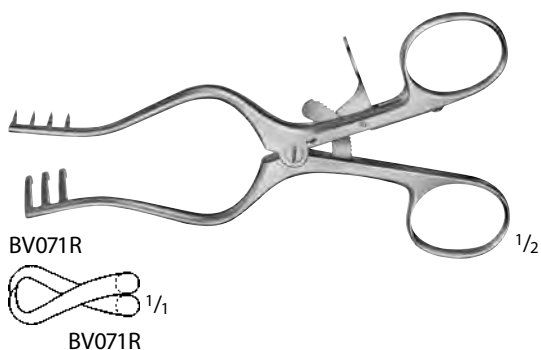
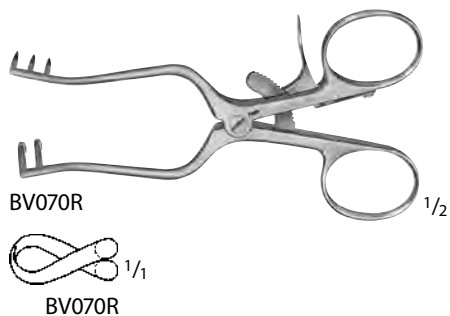

WEITLANER Retractor

Catalog Number	Tip	Blade End	Length (in.)
BV070R	SHARP	2 x 3 PRONGS	4 1/4
BV071R	SHARP	3 x 4 PRONGS	5 1/8
BV072R	SHARP	3 x 4 PRONGS	6 1/2
BV101R	SHARP/DEEP	3 x 4 PRONGS	5 1/8
BV066R	SEMI-S	2 x 3 PRONGS	4 1/4
BV067R	SEMI-S	3 x 4 PRONGS	5 1/8
BV068R	SEMI-S	3 x 4 PRONGS	6 1/2

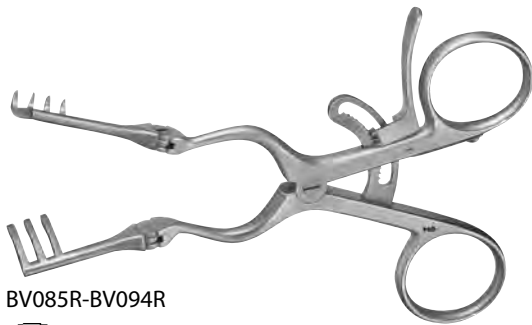
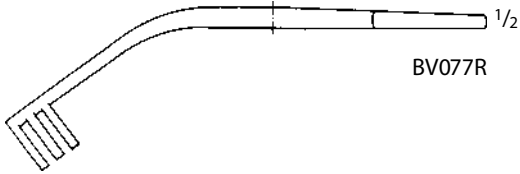
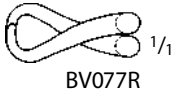
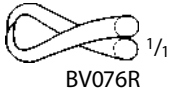

MG007R

WULLSTEIN Retractor

Catalog Number	Tip	Blade End	Length (in.)
BV076R	SHARP	3 x 3 PRONGS	5
BV077R	BLUNT	3 x 3 PRONGS	5

Baby ADSON Retractor, Hinged

Catalog Number	Tip	Blade End	Length (in.)
BV085R	SEMI-S	3 x 4 PRONGS	5 1/2
BV094R	SEMI-S	3 x 4 PRONGS	6 1/2

Baby ADSON Retractor, Angled

Catalog Number	Tip	Blade End	Length (in.)
MG007R	BLUNT	4 x 4 PRONGS	7 1/2

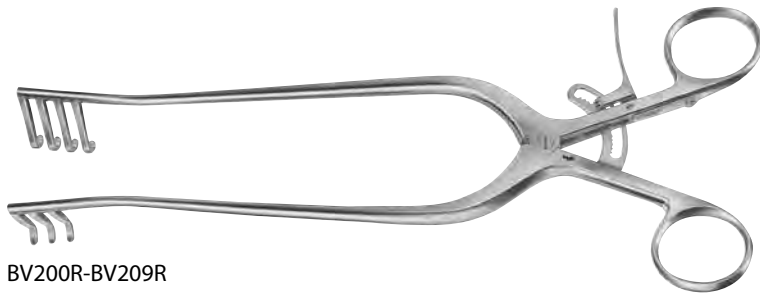

BV200R-BV209R

WEITLANER Retractor

Catalog Number	Tip	Blade End	Length (in.)
BV200R	SHARP	3 x 4 PRONGS	7 7/8
BV206R	SHARP	3 x 4 PRONGS	9 1/2
BV208R	SHARP	5 x 6 PRONGS	10
BV201R	BLUNT	3 x 4 PRONGS	7 7/8
BV207R	BLUNT	3 x 4 PRONGS	9 1/2
BV209R	BLUNT	5 x 6 PRONGS	10

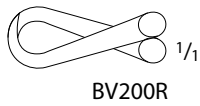

BV200R

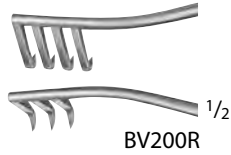

BV200R

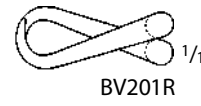

BV201R

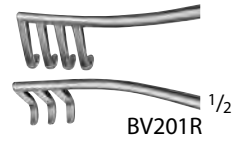

BV201R

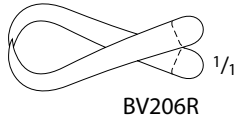

BV206R

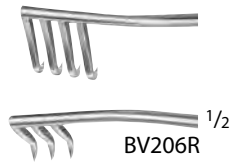

BV206R

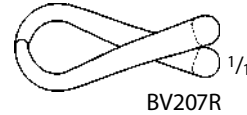

BV207R

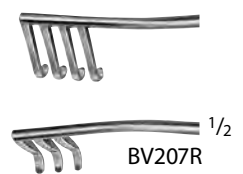

BV207R

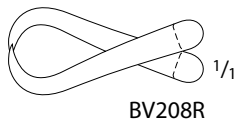

BV208R

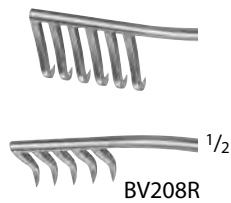

BV208R

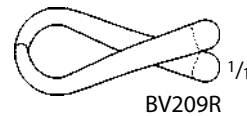

BV209R

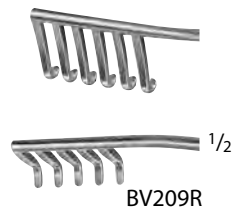

BV209R



MB476R

MISKIMON Cerebellar Retractor

Catalog Number	Tip	Blade End	Length (in.)
MB476R	SHARP	7 x 7 PRONGS	7 7/8

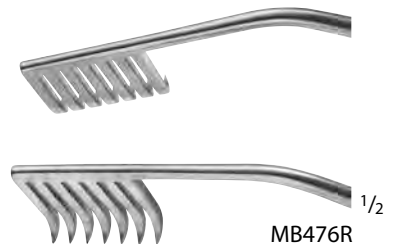

MB476R

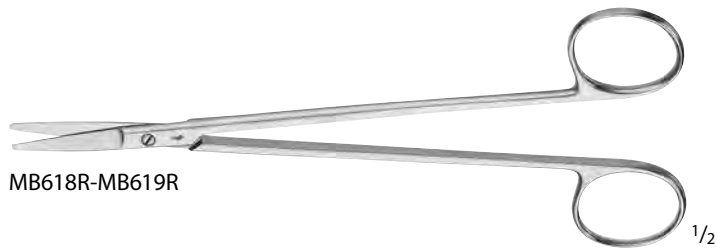

MB618R-MB619R

1/2

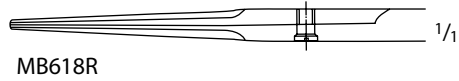

MB618R

1/1

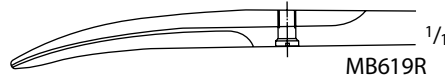

MB619R

CHURCH Scissors, Beveled

Catalog Number	Tip	Blade	Length (in.)
MB618R	B/B	STR	7
MB619R	B/B	CVD	7

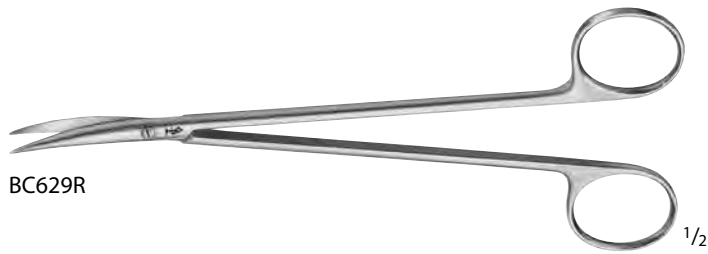

BC629R

1/2

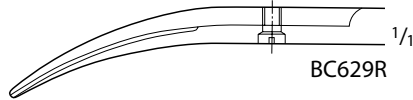

BC629R

1/1

DEBAKEY Arteriotomy Scissors

Catalog Number	Tip	Blade	Length (in.)
BC629R	B/B	CVD	6 7/8

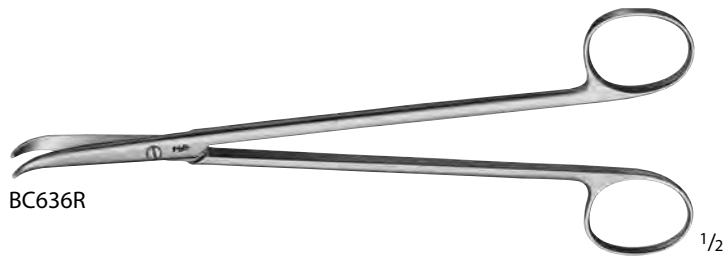

BC636R

1/2

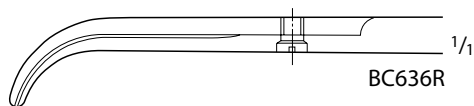

BC636R

1/1

THOREK Scissors

Catalog Number	Tip	Blade	Length (in.)
BC636R	B/B	HEAVY-CVD	7

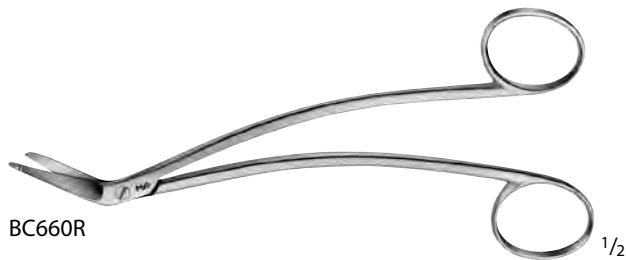

BC660R

1/2

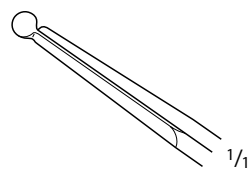

BC660R

SCHMIEDEN-TAYLOR Dura Scissors

Catalog Number	Tip	Blade	Length (in.)
BC660R	1 BALL-PT	ANG	6 1/8

SATINSKY Vena Cava Scissors

Catalog Number	Blade	Length (in.)
BC641R	CVD	9 5/8

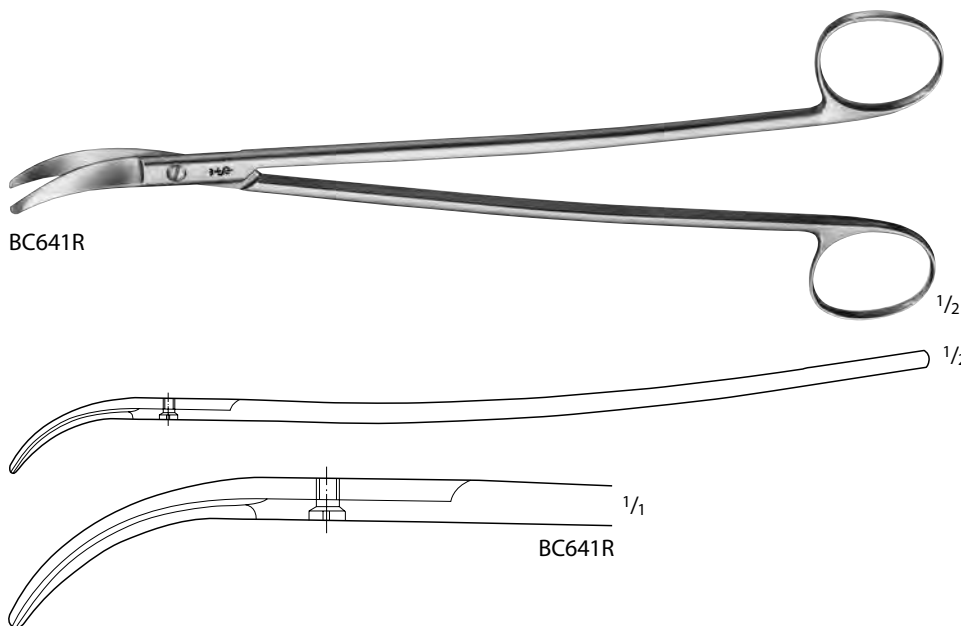

BC641R

STRULLY Scissors

Catalog Number	Tip	Blade	Length (in.)
BC644R	S/S	CVD	8 3/4

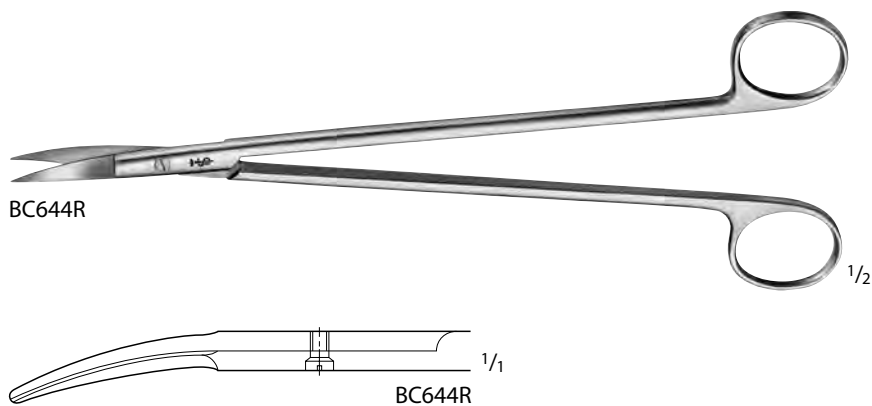

BC644R

STRULLY Scissors

Catalog Number	Tip	Blade	Length (in.)
BC645R	PROBE	CVD	8 3/4

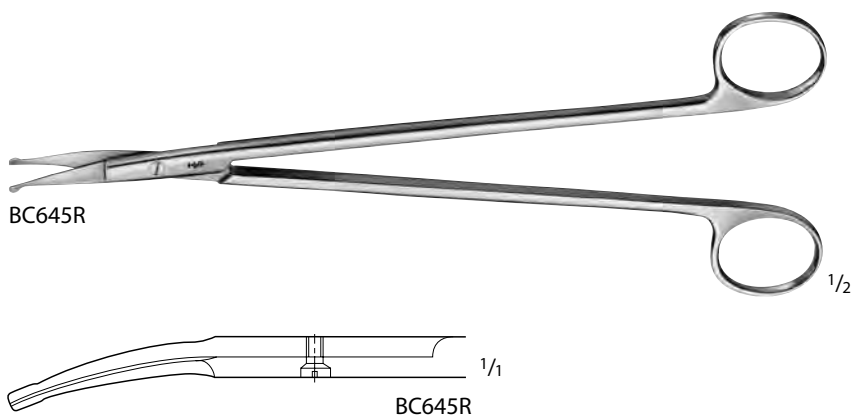

BC645R

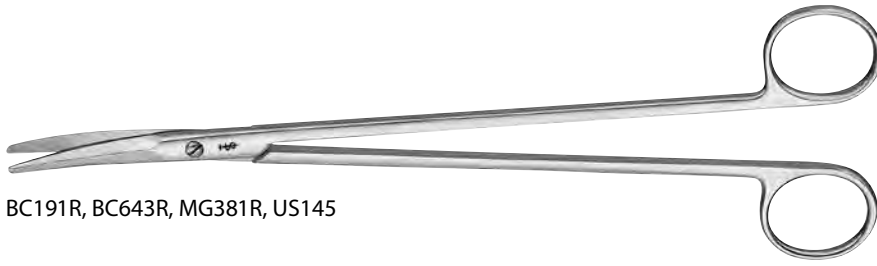

BC191R, BC643R, MG381R, US145

POTTS-SMITH Dissecting Scissors

Catalog Number	Tip	Blade	Length (in.)
MG381R	B/B	CVD	5 1/2
BC643R	B/B	CVD	7 1/2
BC191R	B/B	CVD	9
US145	B/B	CVD	11 1/4

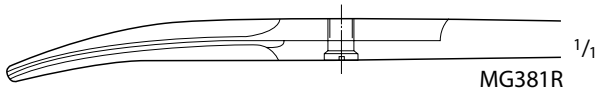

MG381R

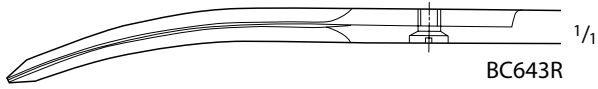

BC643R



BC191R



US145

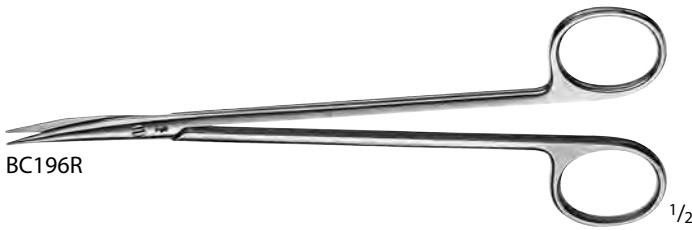

BC196R



BC196R

MORSE Scissors

Catalog Number	Tip	Blade	Length (in.)
BC196R	S/S	CVD	6 7/8

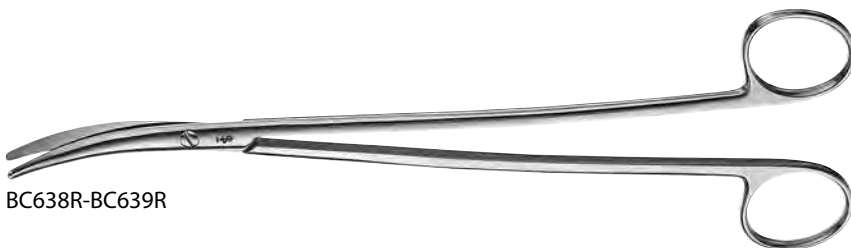

BC638R-BC639R

HOHENFELLNER Scissors

Catalog Number	Tip	Blade	Length (in.)
BC638R	B/B	CVD	8 7/8
BC639R	B/B	CVD	10

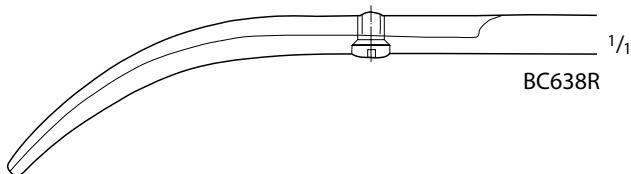

BC638R

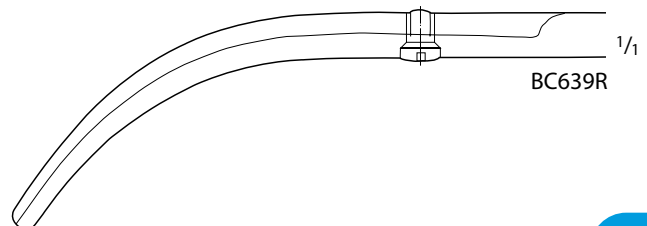

BC639R

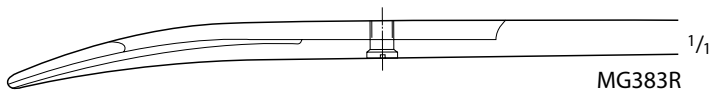
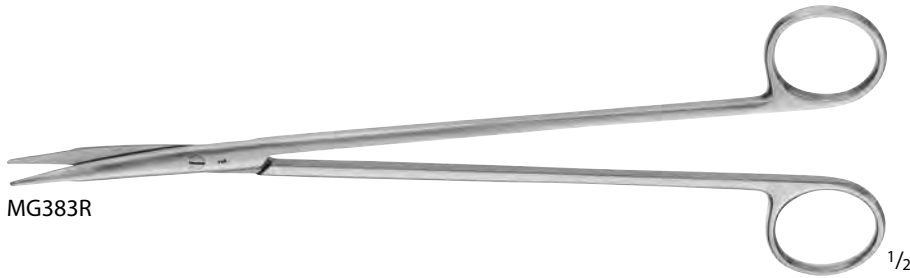

JAMESON-METZENBAUM Scissors

Catalog Number	Tip	Blade	Length (in.)
MG383R	S/S	CVD	9



LILLEHEI-POTTS Tenotomy Scissors

Catalog Number	Tip	Blade	Length (in.)
MG382R	S/S	CVD	7

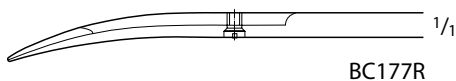
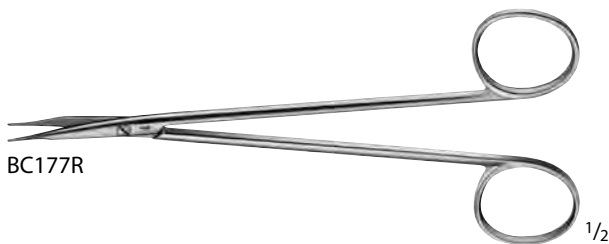

JAMESON Tenotomy Scissors, Delicate

Catalog Number	Tip	Blade	Length (in.)
BC177R	B/B	CVD	6

POTTS Tenotomy Scissors

Catalog Number	Tip	Blade	Length (in.)
BC178R	B/B	CVD	6 7/8
BC179R	B/B	CVD	8

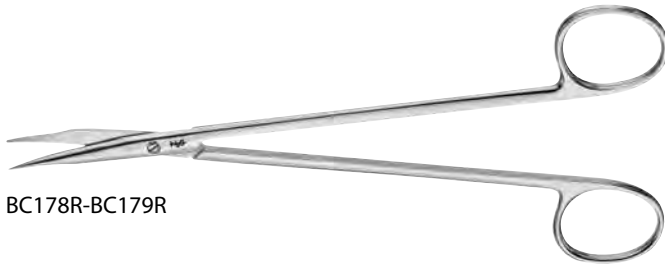

BC178R-BC179R



BC178R



BC179R

JAMESON SuperCut Scissors, Delicate

Catalog Number	Tip	Blade	Length (in.)
BC911R	B/B	CVD	5 1/8
BC915R	B/B	CVD	6
BC919R	B/B	CVD	7



BC911R, BC915R, BC919R



BC911R



BC915R

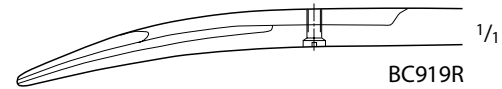

BC919R

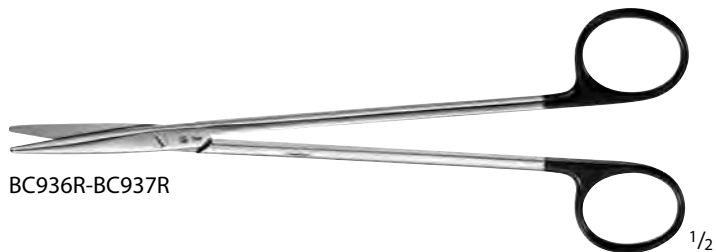

BC936R-BC937R

METZENBAUM SuperCut Scissors

Catalog Number	Tip	Blade	Length (in.)
BC936R	B/B	STR	7
BC937R	B/B	CVD	7

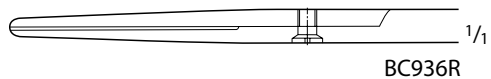

BC936R

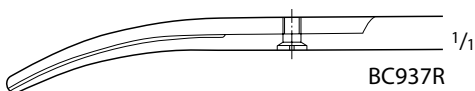

BC937R

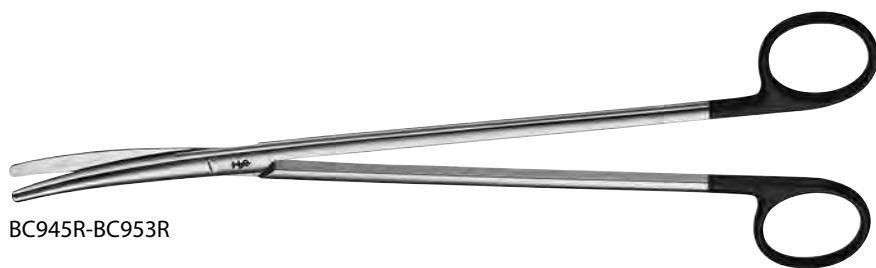

BC945R-BC953R

METZENBAUM SuperCut Scissors

Catalog Number	Tip	Blade	Length (in.)
BC945R	B/B	CVD	9
BC947R	B/B	CVD	10 1/4
BC949R	B/B	CVD	11 1/4
BC951R	B/B	CVD	11 3/4
BC953R	B/B	CVD	14

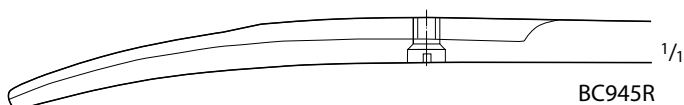

BC945R



BC947R

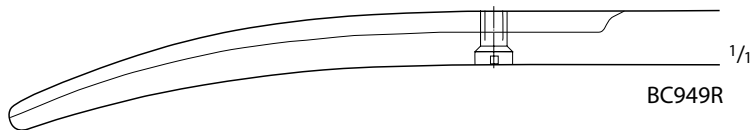

BC949R

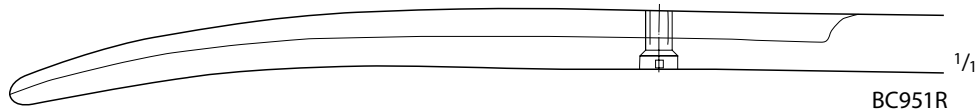

BC951R

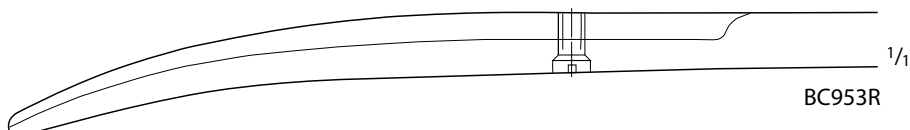

BC953R

GORNEY Scissors

Catalog Number	Tip	Blade	Length (in.)
BC188R	B/B	STR	7 3/4
BC189R	B/B	SLIGHT-CVD	7 3/4



BC188R-BC189R

1/2

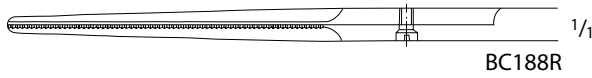

BC188R

1/1

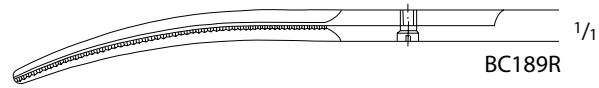

BC189R

1/1

COOLEY Cardiovascular Scissors

Catalog Number	Tip	Blade	Length (in.)
BC597R	B/B	CVD	7 1/2
BC599R	B/B	CVD	9



BC597R-BC599R

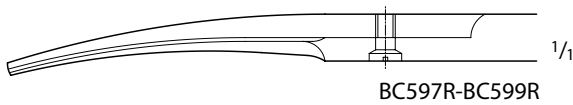

BC597R-BC599R

1/1

POTTS-SMITH Lateral Angle Scissors

Catalog Number	Tip	Blade Angle	Blade Length (mm)	Length (in.)
BC646R	S/S	55°	19	7

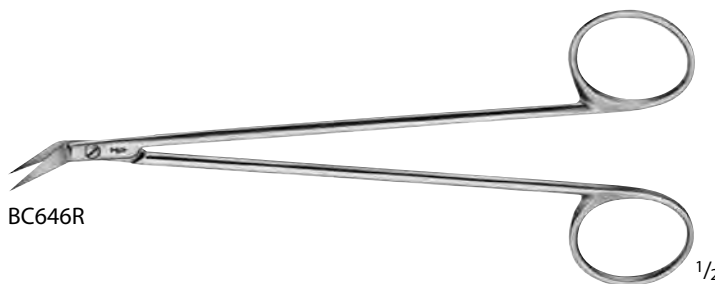

BC646R

1/2

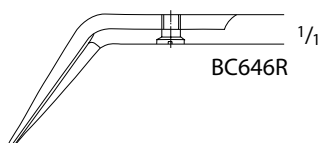

BC646R

1/1



BC655R



BC655R

POTTS-SMITH Reverse Scissors

Catalog Number	Tip	Blade Angle	Handle	Length (in.)
BC655R	S/S	130°	W/ STABILIZING BAR	7

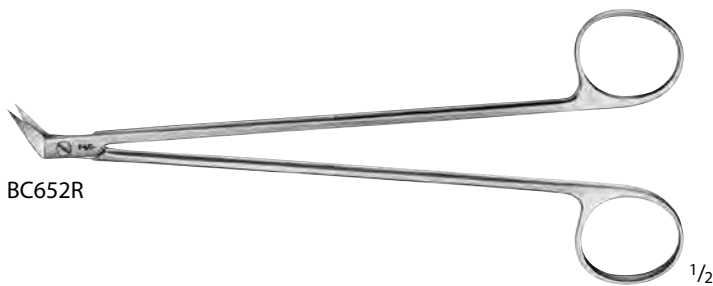

BC652R



BC652R

POTTS-SMITH Vessel Scissors

Catalog Number	Tip	Blade Angle	Blade Length (mm)	Length (in.)
BC652R	S/S	60°	10	6 7/8

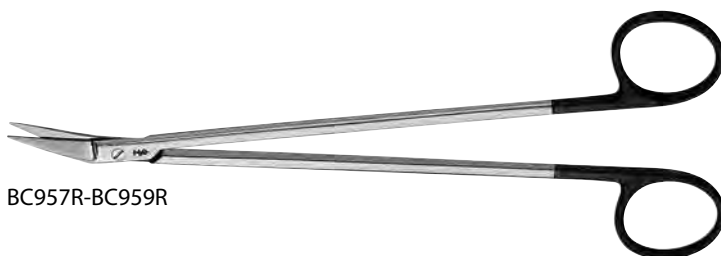

BC957R-BC959R



BC957R



BC958R



BC959R

POTTS-SMITH SuperCut Scissors

Catalog Number	Tip	Blade Angle	Blade Length (mm)	Length (in.)
BC957R	B/B	25°	22	7 1/2
BC958R	B/B	45°	20	7 1/4
BC959R	B/B	60°	19	7

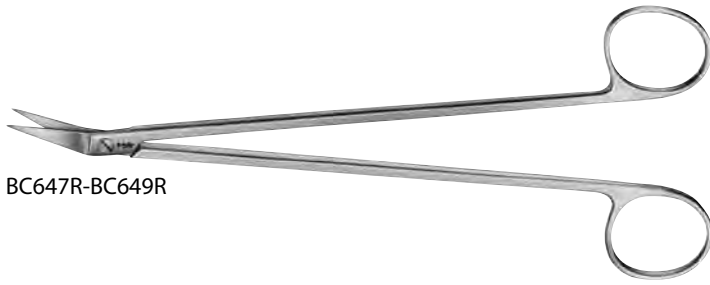

BC647R-BC649R

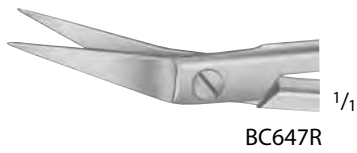

BC647R



BC648R



BC649R

POTTS-DE MARTEL Scissors

Catalog Number	Tip	Blade Angle	Blade Length (mm)	Length (in.)
BC647R	S/S	30°	21	7 1/4
BC648R	S/S	45°	21	7 1/4
BC649R	S/S	60°	21	7 1/4
BC650R	S/S	60°	21	8 3/4

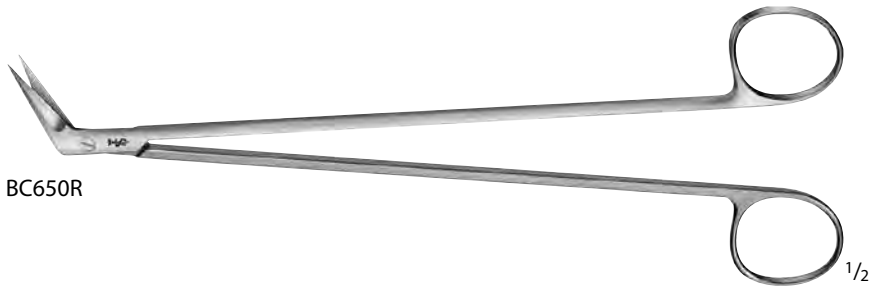

BC650R

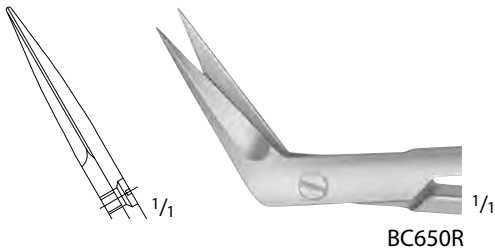

BC650R

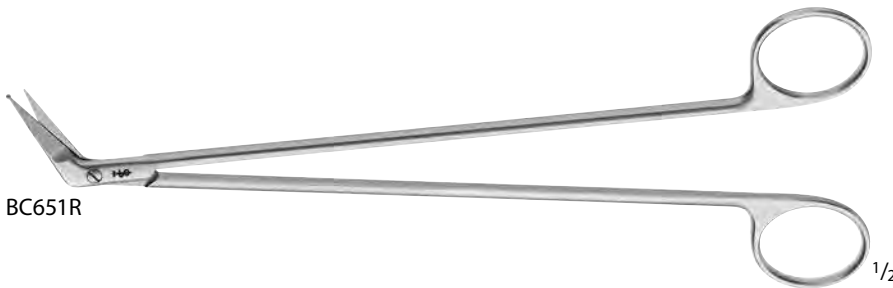

BC651R

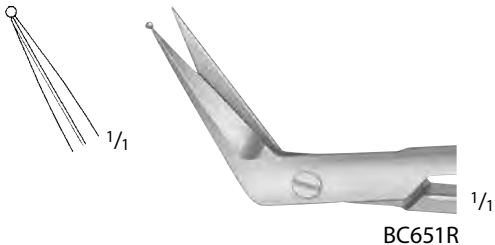

BC651R

MILLS Scissors

Catalog Number	Tip	Blade	Blade Length (mm)	Length (in.)
BC651R	1 BALL-POINT	60°	23	8 3/4

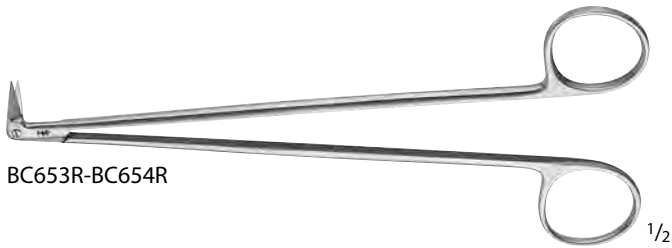

BC653R-BC654R

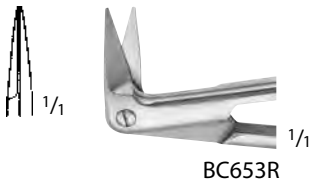

BC653R



BC654R

DIETHRICH Vessel Scissors

Catalog Number	Tip	Blade Angle	Blade Length (mm)	Length (in.)
BC653R	S/S	90°	12	6 3/4
BC654R	S/S	120°	10	6 3/4

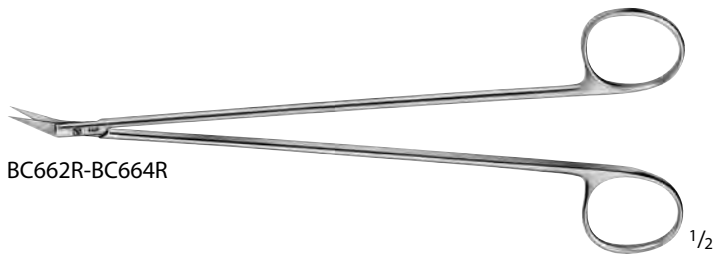

BC662R-BC664R



BC662R

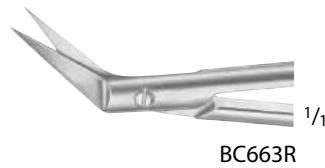

BC663R

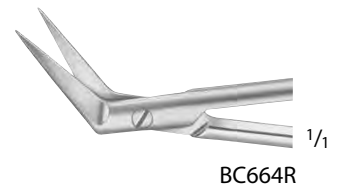

BC664R

DIETHRICH-HEGEMANN Vessel Scissors

Catalog Number	Tip	Blade Angle	Blade Length (mm)	Length (in.)
BC662R	S/S	25°	15	7
BC663R	S/S	45°	15	7
BC664R	S/S	60°	15	7

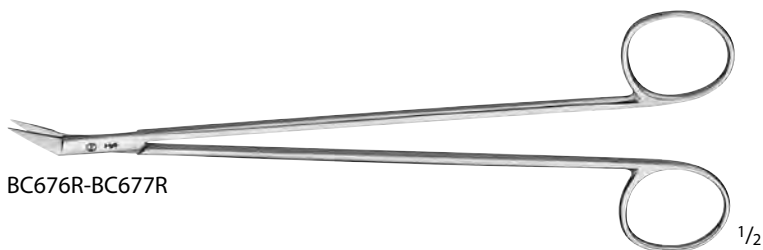

BC676R-BC677R



BC676R



BC677R

DIETHRICH Coronary Artery Scissors

Catalog Number	Tip	Blade Angle	Blade Length (mm)	Length (in.)
BC676R	S/S	25°	13	7 1/4
BC677R	S/S	45°	14	7 1/4

COOLEY Arteriotomy Scissors

Catalog Number	Tip	Blade Angle	Blade Length (mm)	Length (in.)
BC678R	B/B	30°	21.5	8 7/8
BC679R	B/B	30°	21.5	10 3/4

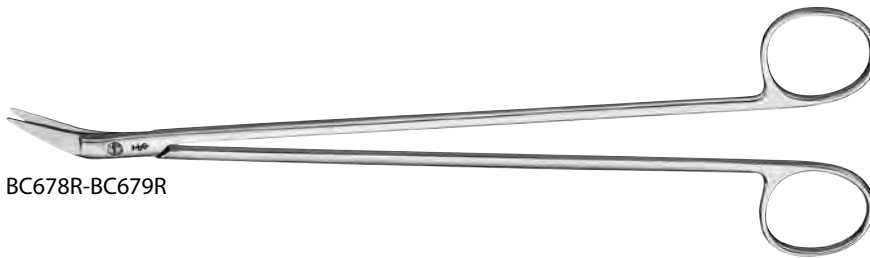

BC678R-BC679R



BC678R



BC679R

DEBAKEY Vessel Scissors

Catalog Number	Tip	Blade Angle	Blade Length (mm)	Length (in.)
BC656R	S/S	45°	18	6 1/8
BC657R	S/S	60°	18	6 1/8

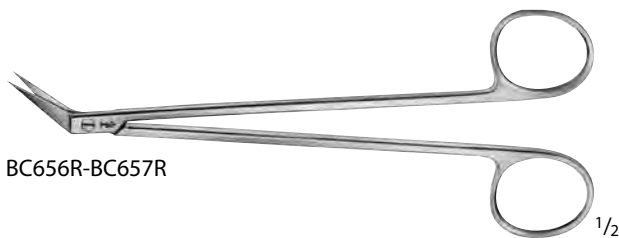

BC656R-BC657R

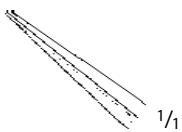

BC656R



BC656R



BC657R

DEBAKEY Offset Scissors, S-Shaped

Catalog Number	Tip	Blade Angle	Blade Length (mm)	Length (in.)
BC669R	S/S	45°	24	6 1/8



BC669R

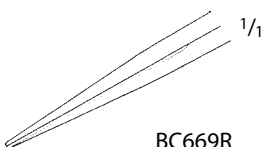

BC669R

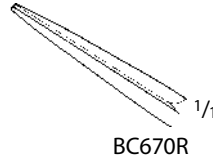
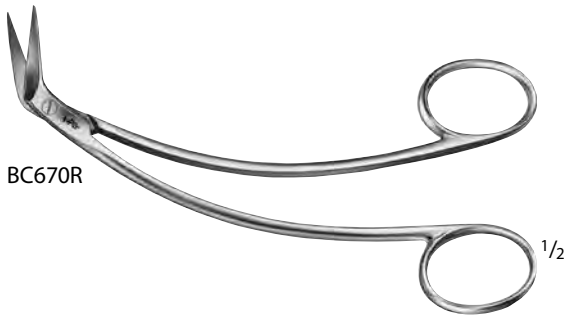

FAVOLORO Artery Scissors

Catalog Number	Tip	Blade Angle	Blade Length (mm)	Length (in.)
BC670R	S/S	45°	20	5 1/2

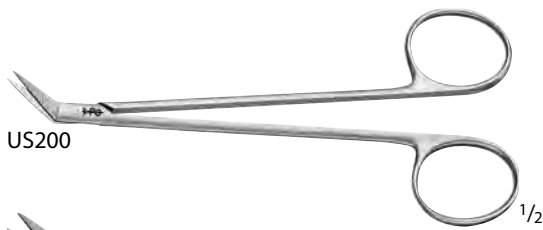

POTTS Vascular Scissors

Catalog Number	Tip	Blade Angle	Blade Length (mm)	Length (in.)
US200	S/S	45°	13	5 1/4



Valve Leaflet Excision Scissors

Catalog Number	Tip	Blade Angle	Length (in.)
MB064R	B/B	45°	5 3/4



POTTS Arteriotomy Scissors

Catalog Number	Tip	Blade Angle	Length (in.)
MB065R	B/B	60°	5 3/8



COOLEY Neonatal Scissors

Catalog Number	Tip	Blade	Length (in.)
MB204R	S/S	CVD	5 3/4

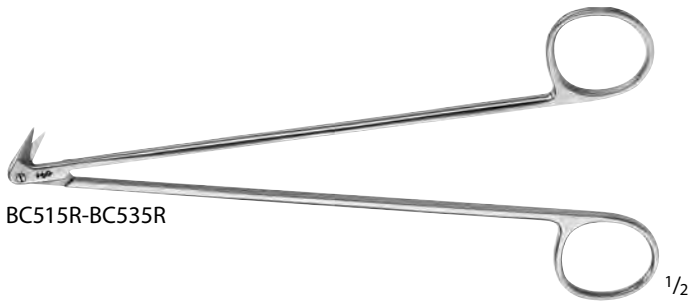

BC515R-BC535R

DIETHRICH-POTTS Micro Scissors

Catalog Number	Tip	Blade	Blade Angle	Blade Length (mm)	Length (in.)
BC515R	S/S	X-DEL	25°	8	7
BC516R	S/S	X-DEL	45°	8	7
BC517R	S/S	X-DEL	60°	8	7
BC518R	S/S	X-DEL	90°	8	7
BC519R	S/S	X-DEL	125°	8	7
BC531R	S/S	DEL	25°	10	7
BC532R	S/S	DEL	45°	10	7
BC533R	S/S	DEL	60°	10	7
BC534R	S/S	DEL	90°	10	7
BC535R	S/S	DEL	125°	10	7
BC522R	S/S	FINE	25°	12	7
BC523R	S/S	FINE	45°	12	7
BC524R	S/S	FINE	60°	12	7
BC525R	S/S	FINE	90°	12	7
BC526R	S/S	FINE	125°	12	7

Blade Length:8 MM

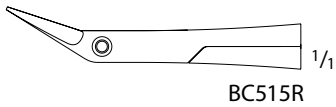

BC515R

Blade Length:10 MM

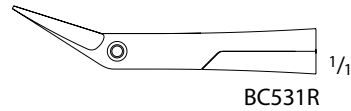

BC531R

Blade Length:12 MM

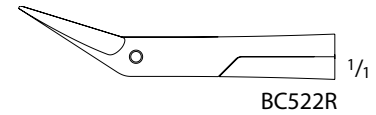

BC522R

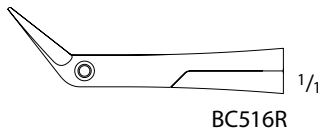

BC516R

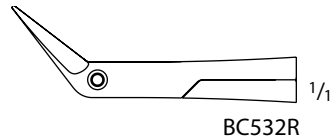

BC532R

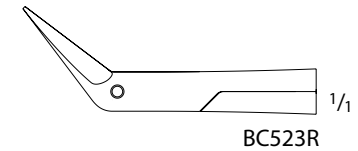

BC523R

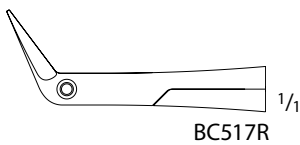

BC517R

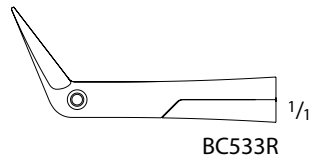

BC533R

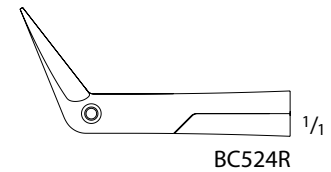

BC524R

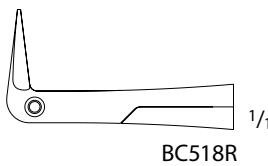

BC518R

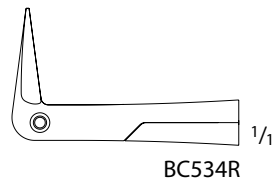

BC534R

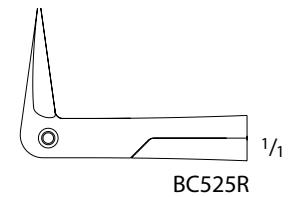

BC525R

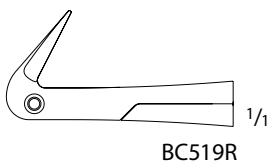

BC519R

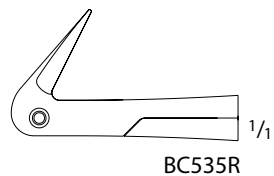

BC535R

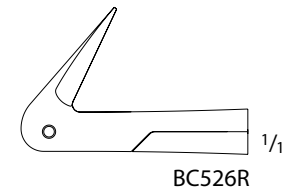

BC526R



DIETHRICH SuperCut Scissors

Catalog Number	Tip	Blade	Length (in.)
MG346R	S/S	25°	7
MG347R	S/S	45°	7
MG348R	S/S	60°	7
MG349R	S/S	90°	7
MG350R	S/S	125°	7



DUROTIP TC Tungsten Carbide Scissors

- Excellent cutting accuracy
- Long working life
- Gold-plated rings

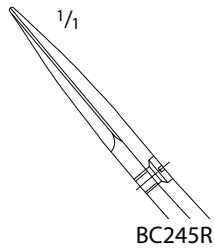
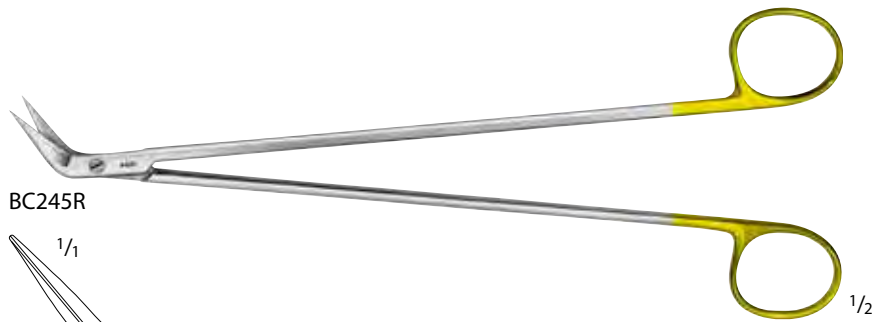
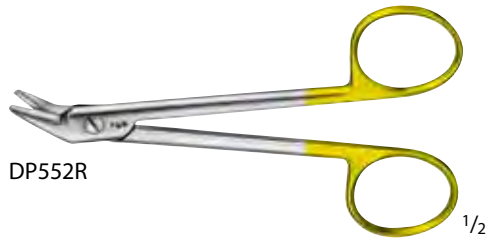

DUROTIP TC Wire Cutting Scissors

Catalog Number	Blade	For Wire Size	Length (in.)
DP552R	1-SERR	SOFT, UP TO 1.2 MM AND HARD, UP TO 0.8 MM	4 3/4

DUROTIP TC DEBAKEY Vascular Scissors

Catalog Number	Tip	Blade Angle	Blade Length (mm)	Length (in.)
BC245R	S/S	60°	21	8 3/4

DUROTIP TC DEMARTEL Vascular Scissors

Catalog Number	Tip	Blade	Length (in.)
MB212R	S/S	CVD	6 3/4



BC258R-BC259R

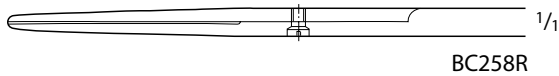

BC258R

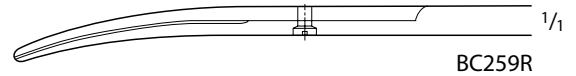

BC259R

DUROTIP TC Baby METZENBAUM Dissecting Scissors, Delicate

Catalog Number	Tip	Blade	Length (in.)
BC258R	B/B	STR	5 3/4
BC259R	B/B	CVD	5 3/4



BC260R-BC265R

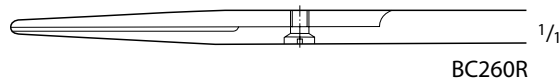

BC260R

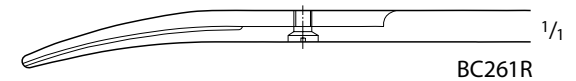

BC261R

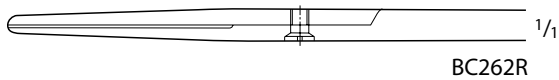

BC262R

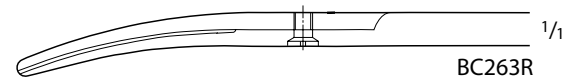

BC263R

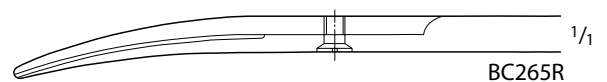

BC265R

DUROTIP TC METZENBAUM Dissecting Scissors

Catalog Number	Tip	Blade	Length (in.)
BC260R	B/B	STR	5 3/4
BC262R	B/B	STR	7
BC261R	B/B	CVD	5 3/4
BC263R	B/B	CVD	7
BC265R	B/B	CVD	7 7/8
BC287R	B/B	CVD	9

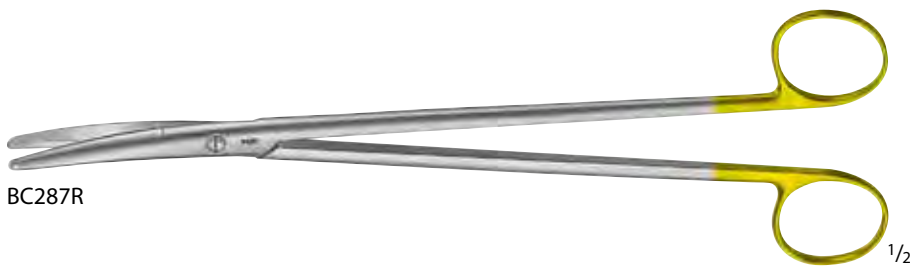

BC287R

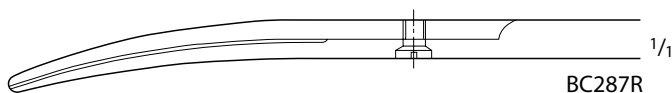

BC287R

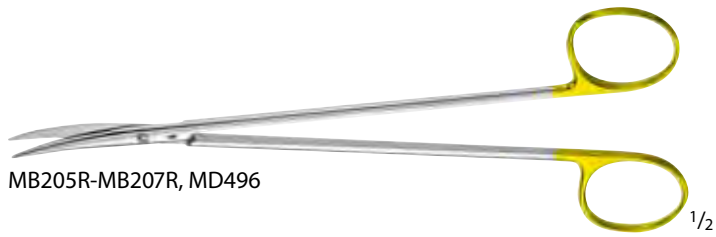

MB205R-MB207R, MD496



MB205R



MB207R



MD496



MB206R

DUROTIP TC METZENBAUM Dissecting Scissors, Delicate

Catalog Number	Tip	Blade	Length (in.)
MB205R	S/S	STR	9 1/4
MB207R	S/S	CVD	5 3/4
MD496	S/S	CVD	7
MB206R	S/S	CVD	9 1/4



BC558R-BC559R

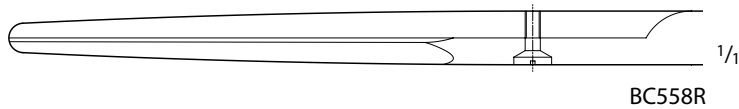

BC558R

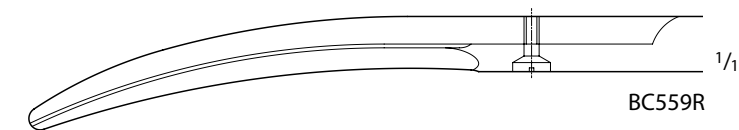

BC559R

DUROTIP TC MAYO Dissecting Scissors

Catalog Number	Tip	Blade	Length (in.)
BC558R	B/B	STR	9
BC559R	B/B	CVD	9



Wavecut

■ Wavecut scissors have one serrated cutting edge to prevent tissue from slipping. The W after the item number indicates the scissors are the wavecut style, e.g. BC211W.

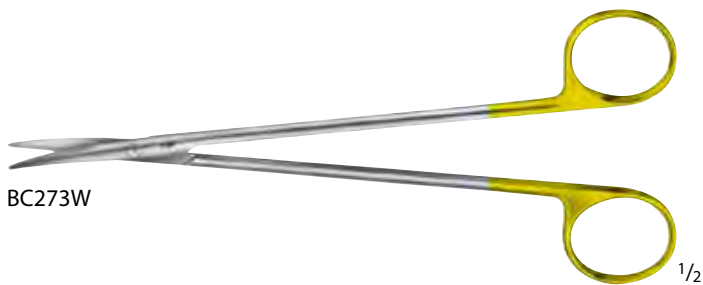

BC273W

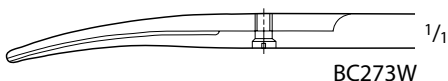

BC273W



BC259W

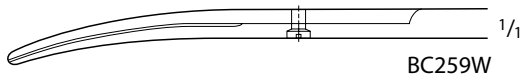

BC259W

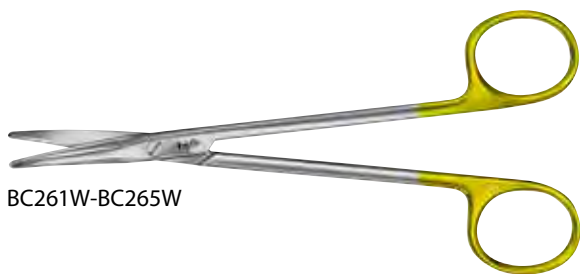

BC261W-BC265W

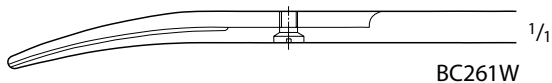

BC261W

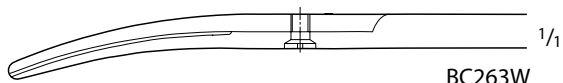

BC263W

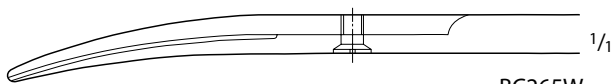

BC265W

DUROTIP TC TOENNIS-ADSON Wavecut Dissecting Scissors

Catalog Number	Tip	Blade	Length (in.)
BC273W	B/B	CVD	6 7/8

DUROTIP TC Baby METZENBAUM Wavecut Dissecting Scissors, Delicate

Catalog Number	Tip	Blade	Length (in.)
BC259W	B/B	CVD	5 3/4

DUROTIP TC METZENBAUM Wavecut Dissecting Scissors

Catalog Number	Tip	Blade	Length (in.)
BC261W	B/B	CVD	5 3/4
BC263W	B/B	CVD	7
BC265W	B/B	CVD	7 7/8

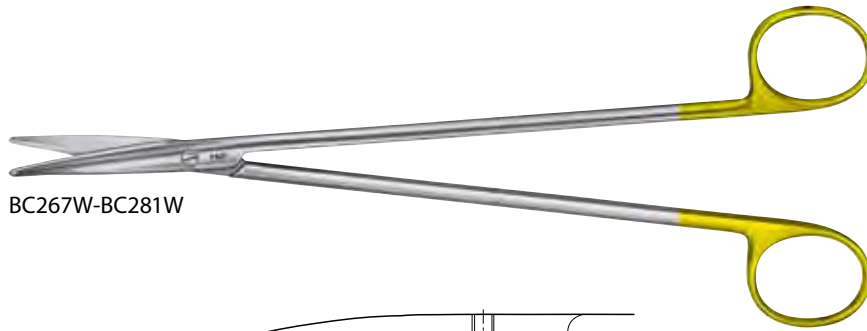

BC267W-BC281W

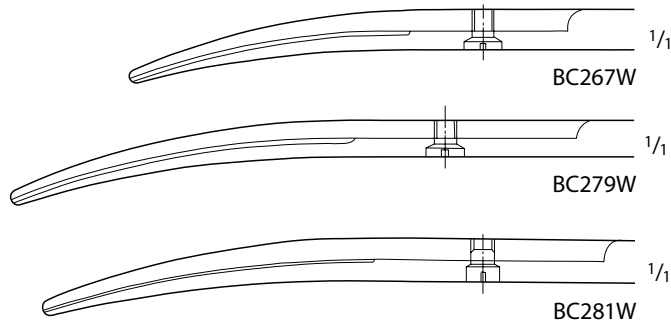

DUROTIP TC NELSON-METZENBAUM
Wavecut Dissecting Scissors

Catalog Number	Tip	Blade	Length (in.)
BC267W	B/B	CVD	9
BC279W	B/B	CVD	10 1/4
BC281W	B/B	CVD	11

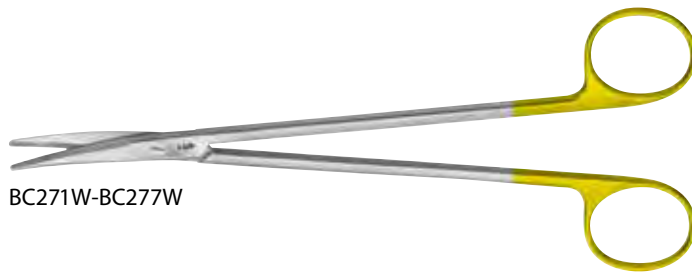

BC271W-BC277W

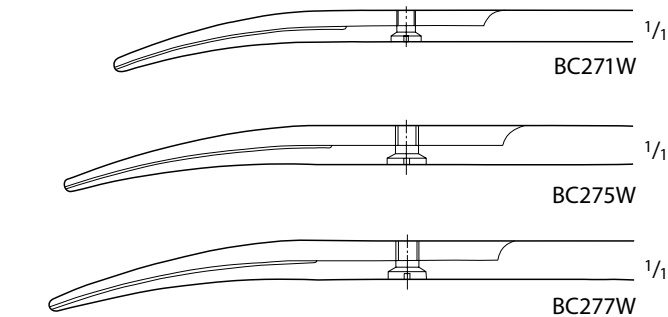

DUROTIP TC METZENBAUM Wavecut
Dissecting Scissors, Delicate

Catalog Number	Tip	Blade	Length (in.)
BC271W	B/B	CVD	7
BC275W	B/B	CVD	7 7/8
BC277W	B/B	CVD	9



BC287W

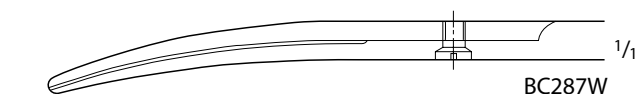

DUROTIP TC METZENBAUM Wavecut
Dissecting Scissors, Heavy

Catalog Number	Tip	Blade	Length (in.)
BC287W	B/B	CVD	9

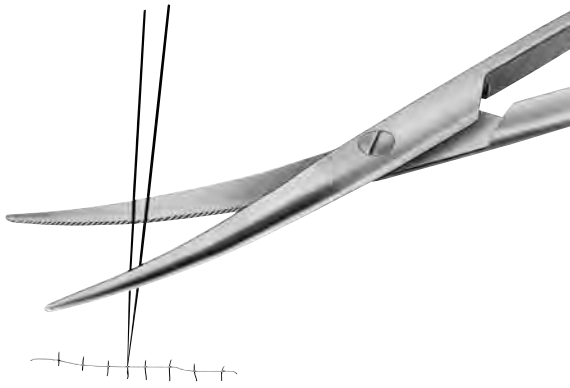

DUROTIP TC Ligature Scissors

- Carbide inserts help ensure sharp cutting edge (also in the distal area of the blades).
- Wavecut helps prevent suture materials from slipping.
- Identified by 1 gold-plated ring.



BC294W-BC298W

DUROTIP TC Ligature Wavecut Scissors

Catalog Number	Tip	Blade	Length (in.)
BC294W	B/B	CVD	5 3/4
BC295W	B/B	CVD	7
BC296W	B/B	CVD	9
BC297W	B/B	CVD	10 1/4
BC298W	B/B	CVD	13 3/4

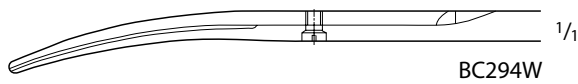

BC294W

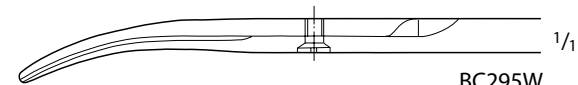

BC295W

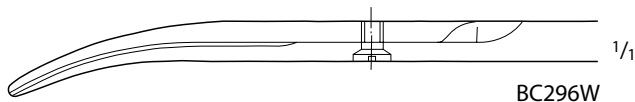

BC296W

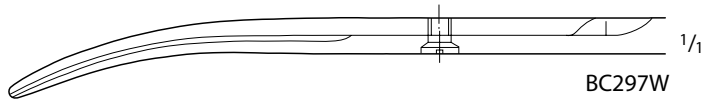

BC297W

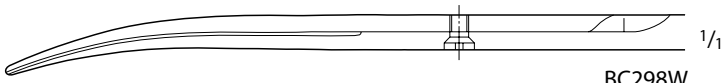

BC298W

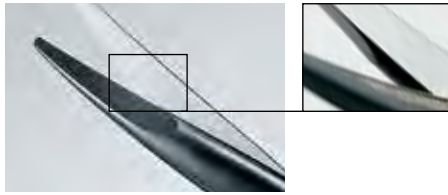

Microtome Edge

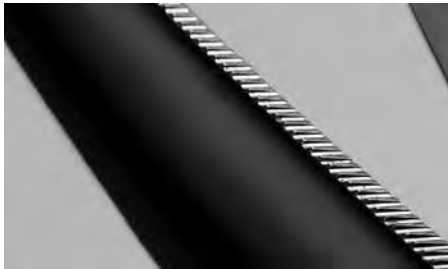

Wavecut

Noir Supreme Cut Scissors

- **Noir**
 The combination of the renowned Tungsten Carbide technology with the Noir coating results in an extremely high surface hardness and therefore high wear resistance in daily hospital use.
- **Microtome edge**
 The extremely sharp cutting edge of the scissors blade facilitates gentle cutting of tissue with minimal use of force.
- **Wavecut** helps prevent tissue from slipping out during the cutting process.
- The WB after the item number indicates the Noir scissors are the wavecut style, e.g. BC211WB.



BC252B-BC253WB

1/2



BC252B

1/1



BC253B, BC253WB

1/1

Noir MAYO Dissecting Scissors

Catalog Number	Tip	Blade	Length (in.)
BC252B	B/B	STR	6 3/4
BC253B	B/B	CVD	6 3/4
BC253WB	B/B	CVD	6 3/4



BC284B-BC284WB

1/2



BC284B-BC284WB

1/1

Noir MAYO-LEXER Dissecting Scissors

Catalog Number	Tip	Blade	Length (in.)
BC284B	B/B	CVD	6 1/2
BC284WB	B/B	CVD	6 1/2



BC283B-BC283WB

1/2



BC283B-BC283WB

1/1

Noir LEXER Dissecting Scissors

Catalog Number	Tip	Blade	Length (in.)
BC283B	B/B	DEL, CVD	6 1/2
BC283WB	B/B	DEL, CVD	6 1/2



BC210B-BC211WB

1/2



BC210B

1/1



BC211B, BC211WB

1/1

Noir Iris Dissecting Scissors

Catalog Number	Tip	Blade	Length (in.)
BC210B	S/S	STR	4 1/4
BC211B	S/S	CVD	4 1/4
BC211WB	S/S	CVD	4 1/4



BC273B-BC273WB

1/2



BC273B-BC273WB

1/1

Noir TOENNIS-ADSON Dissecting Scissors

Catalog Number	Tip	Blade	Length (in.)
BC273B	B/B	DEL, CVD	6 7/8
BC273WB	B/B	DEL, CVD	6 7/8



BC261B-BC277WB



BC261B, BC261WB



BC263B, BC263WB



BC271B, BC271WB



BC265B, BC265WB



BC275B, BC275WB



BC267B, BC267WB



BC277B, BC277WB

Noir METZENBAUM Dissecting Scissors

Catalog Number	Tip	Blade	Length (in.)
BC261B	B/B	CVD	5 3/4
BC261WB	B/B	CVD	5 3/4
BC263B	B/B	CVD	7
BC263WB	B/B	CVD	7
BC271B	B/B	DEL, CVD	7
BC271WB	B/B	DEL, CVD	7
BC265B	B/B	CVD	7 7/8
BC265WB	B/B	CVD	7 7/8
BC275B	B/B	DEL, CVD	7 7/8
BC275WB	B/B	DEL, CVD	7 7/8
BC267B	B/B	CVD	9
BC267WB	B/B	CVD	9
BC277B	B/B	DEL, CVD	9
BC277WB	B/B	DEL, CVD	9

Let Us know if you could not find what you are looking for

Noir NELSON-METZENBAUM
 Dissecting Scissors

Catalog Number	Tip	Blade	Length (in.)
BC279B	B/B	DEL, CVD	10 1/4
BC279WB	B/B	DEL, CVD	10 1/4
BC281B	B/B	DEL, CVD	11
BC281WB	B/B	DEL, CVD	11



BC279B-BC281WB



BC279B, BC279WB



BC281B, BC281WB



FD020R-FD021R

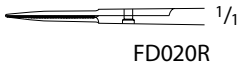

FD020R

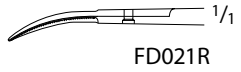

FD021R

MILLESI Micro Scissors

Catalog Number	Tip	Blade	Handle	Length (in.)
FD020R	S/S	STR, SERR	FLAT, SERR	6 1/4
FD021R	S/S	CVD, SERR	FLAT, SERR	6 1/4



FD028R

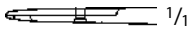

FD028R

MILLESI Micro Scissors

Catalog Number	Tip	Blade	Handle	Length (in.)
FD020R	S/S	STR, SERR	FLAT, SERR	6 1/4
FD021R	S/S	CVD, SERR	FLAT, SERR	6 1/4

BIEMER Vein Scissors

Catalog Number	Blade	Handle	Length (in.)
FD028R	STR	FLAT, SERR	5 1/8



FD022R-FD023R

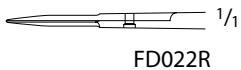

FD022R

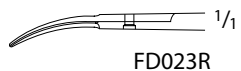

FD023R

YASARGIL Micro Vessel Scissors

Catalog Number	Blade	Handle	Length (in.)
FD022R	STR	FLAT, SERR	7 1/4
FD023R	CVD	FLAT, SERR	7 1/4



FM430R-FM474R

1/2

Blade: STR

Blade: 25°

Blade: 45°



FM444R

1/1



FM431R

1/1



FM432R

1/1



FM442R

1/1



FM437R

1/1



FM438R

1/1

Blade: CVD



FM430R

1/1

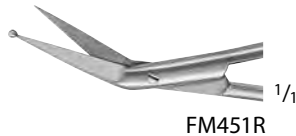

FM451R

1/1



FM452R

1/1



FM436R

1/1



FM470R

1/1



FM471R

1/1

Blade: 60°

Blade: 90°

Blade: 125°



FM433R

1/1



FM434R

1/1



FM435R

1/1



FM439R

1/1



FM440R

1/1



FM441R

1/1



FM453R

1/1



FM454R

1/1



FM455R

1/1



FM472R

1/1



FM473R

1/1



FM474R

1/1

Micro Scissors, Flat Handle

Catalog Number	Tip	Blade	Blade Angle	Blade Length (mm)	Length (in.)
FM444R	S/S	X-DEL	STR	7	6 1/2
FM430R	S/S	X-DEL	CVD	7	6 1/2
FM431R	S/S	X-DEL	25°	7	6 1/2
FM432R	S/S	X-DEL	45°	7	6 1/2
FM433R	S/S	X-DEL	60°	7	6 1/2
FM434R	S/S	X-DEL	90°	7	6 1/2
FM435R	S/S	X-DEL	125°	7	6 1/2
FM442R	S/S	DEL	STR	10	6 1/2
FM436R	S/S	DEL	CVD	10	6 1/2
FM437R	S/S	DEL	25°	10	6 1/2
FM438R	S/S	DEL	45°	10	6 1/2
FM439R	S/S	DEL	60°	10	6 1/2
FM440R	S/S	DEL	90°	10	6 1/2
FM441R	S/S	DEL	125°	10	6 1/2
FM451R	S/1 BALL-PT	FINE	25°	15	6 1/2
FM452R	S/1 BALL-PT	FINE	45°	15	6 1/2
FM453R	S/1 BALL-PT	FINE	60°	15	6 1/2
FM454R	S/1 BALL-PT	FINE	90°	15	6 1/2
FM455R	S/1 BALL-PT	FINE	125°	15	6 1/2
FM470R	S/S	FINE	25°	15	6 1/2
FM471R	S/S	FINE	45°	15	6 1/2
FM472R	S/S	FINE	60°	15	6 1/2
FM473R	S/S	FINE	90°	15	6 1/2
FM474R	S/S	FINE	125°	15	6 1/2

Let Us know if you could not find what you are looking for



Blade: STR



Blade: 25°



Blade: 45°



Blade: CVD



Blade: 60°



Blade: 90°



Blade: 125°

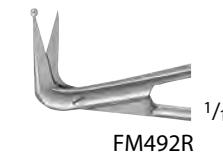

Micro Scissors, Round Handle

Catalog Number	Tip	Blade	Blade Angle	Blade Length (mm)	Length (in.)
FM503R	S/S	X-DEL	CVD	7	6 1/2
FM504R	S/S	X-DEL	25°	7	6 1/2
FM505R	S/S	X-DEL	45°	7	6 1/2
FM506R	S/S	X-DEL	60°	7	6 1/2
FM507R	S/S	X-DEL	90°	7	6 1/2
FM508R	S/S	X-DEL	125°	7	6 1/2
FM488R	S/S	DEL	STR	10	6 1/2
FM481R	S/S	DEL	CVD	10	6 1/2
FM482R	S/S	DEL	25°	10	6 1/2
FM483R	S/S	DEL	45°	10	6 1/2
FM484R	S/S	DEL	60°	10	6 1/2
FM485R	S/S	DEL	90°	10	6 1/2
FM486R	S/S	DEL	125°	10	6 1/2
FM489R	S/1 BALL-PT	DEL	25°	10	6 1/2
FM490R	S/1 BALL-PT	DEL	45°	10	6 1/2
FM491R	S/1 BALL-PT	DEL	60°	10	6 1/2
FM492R	S/1 BALL-PT	DEL	90°	10	6 1/2
FM493R	S/1 BALL-PT	DEL	125°	10	6 1/2
FM476R	S/S	FINE	25°	15	6 1/2
FM477R	S/S	FINE	45°	15	6 1/2
FM478R	S/S	FINE	60°	15	6 1/2
FM479R	S/S	FINE	90°	15	6 1/2
FM480R	S/S	FINE	125°	15	6 1/2

Let Us know if you could not find what you are looking for



FD056R-FD057R

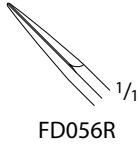

FD056R

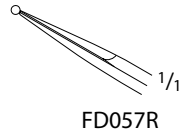

FD057R



FD059R

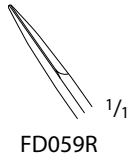

FD059R



FD100R-FD103R

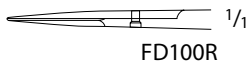

FD100R

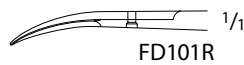

FD101R

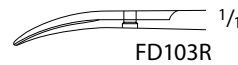

FD103R



FD105R-FD108R

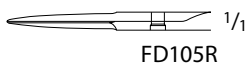

FD105R

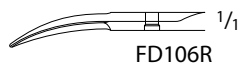

FD106R

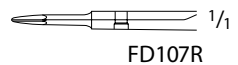

FD107R

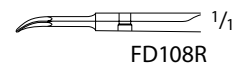

FD108R

NAGEL Micro Scissors

Catalog Number	Tip	Blade	Length (in.)
FD056R	S/S	45°	7 7/8
FD057R	PROBE	45°	7 7/8

DEBAKEY Circumflex Micro Scissors

Catalog Number	Tip	Blade	Length (in.)
FD059R	S/S	125°	7 1/2

Micro Scissors

Catalog Number	Tip	Blade	Handle	Length (in.)
FD100R	S/S	STR	ROUND	5 3/4
FD101R	S/S	CVD	ROUND	5 3/4
FD103R	B/B	CVD	ROUND	5 3/4

Micro Vessel Scissors

Catalog Number	Tip	Blade	Length (in.)
FD105R	S/S	STR	7 1/2
FD106R	S/S	CVD	7 1/2
FD107R	S/S	DEL, STR	7 1/2
FD108R	S/S	DEL, CVD	7 1/2



BM563R-BM564R

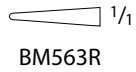

BM563R



BM564R



FD045R-FD046R



FD045R



FD046R



FD048R

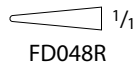

FD048R



FD076R-FD079R

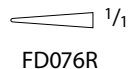

FD076R



FD079R



FD080R-FD081R

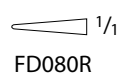

FD080R



FD081R

CASTROVIEJO Micro Needle Holder,
 W/ Catch

Catalog Number	Tip	Jaw	Length (in.)
BM563R	STR	SMOOTH	5 3/4
BM564R	CVD	SMOOTH	5 3/4

JACOBSON Micro Needle Holder

Catalog Number	Handle	Jaw	Length (in.)
FD045R	W/O CATCH	SMOOTH	7 1/4
FD046R	W/ CATCH	SMOOTH	7 1/4

Micro Needle Holder, W/ Catch

Catalog Number	Jaw	Length (in.)
FD048R	SMOOTH	7 7/8

Micro Needle Holder, W/O Catch

Catalog Number	Tip	Jaw	Length (in.)
FD076R	STR	SMOOTH	6 1/4
FD079R	CVD	SMOOTH	6 1/4

Micro Needle Holder, W/O Catch

Catalog Number	Tip	Jaw	Length (in.)
FD080R	STR	SMOOTH	7 1/4
FD081R	CVD	SMOOTH	7 1/4



FD120R



MA360R

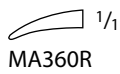

MA360R



BM560R, BM562R

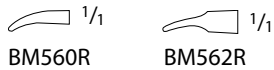

BM560R

BM562R



FD230R-FD231R



FD230R

FD231R



MA352R, MA357R

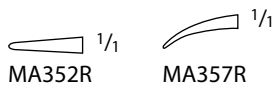

MA352R

MA357R



FD232R-FD233R

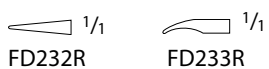

FD232R

FD233R



MA351R, MA358R

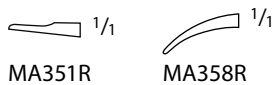

MA351R

MA358R



FD240R-FD241R



FD240R

FD241R

Micro Needle Holder, Bayonet-Shaped

Catalog Number	Tip	Length (in.)
FD120R	CVD-UP	7 3/4

BARRAQUER Micro Needle Holder,
 Round Knurled Handle

Catalog Number	Tip	Handle	Length (in.)
FD230R	STR	W/O CATCH	4 3/4
MA352R	STR	W/O CATCH	5 1/4
BM562R	CVD, DEL	W/O CATCH	4 3/4
MA360R	CVD	W/O CATCH	4 1/4
BM560R	CVD	W/O CATCH	4 1/2
FD231R	CVD	W/O CATCH	4 3/4
MA357R	CVD	W/O CATCH	5 1/4
FD232R	STR	W/ CATCH	4 3/4
MA351R	STR	W/ CATCH	5 1/4
FD233R	CVD	W/ CATCH	4 3/4
MA358R	CVD	W/ CATCH	5 1/4

REILL Micro Needle Holder, W/O Catch

Catalog Number	Tip	Jaw	Length (in.)
FD240R	STR	SMOOTH	6
FD241R	CVD	SMOOTH	6



FD242R-FD243R



FD242R



FD243R



FD244R-FD245R



FD244R



FD245R



FD246R-FD247R



FD246R



FD247R



FM392R



FM392R



FM021R



FM021R

Micro Needle Holder, Round Knurled Handle W/ Catch

Catalog Number	Tip	Jaw	Length (in.)
FD242R	STR	SMOOTH	6
FD243R	CVD	SMOOTH	6

Micro Needle Holder, Round Knurled Handle W/O Catch

Catalog Number	Tip	Jaw	Length (in.)
FD244R	STR	SMOOTH	7 1/4
FD245R	CVD	SMOOTH	7 1/4

Micro Needle Holder, Round Knurled Handle W/ Catch

Catalog Number	Tip	Jaw	Length (in.)
FD246R	STR	SMOOTH	7 1/4
FD247R	CVD	SMOOTH	7 1/4

Round Knurled Handle Micro Needle Holder, W/ Catch

Catalog Number	Tip	Jaw	Length (in.)
FM392R	STR	SMOOTH	9

MUELLER Micro Needle Holder, Plastic Handle W/ Catch

Catalog Number	Tip	Length (in.)
FM021R	CVD	5 3/4

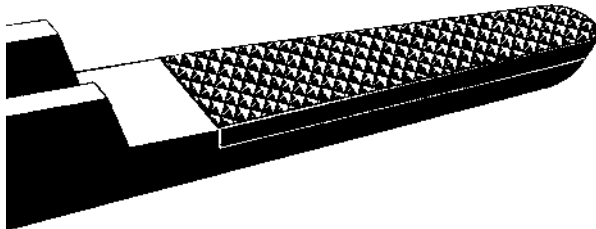
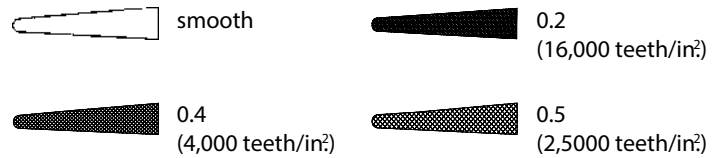

We recommend carbide inserts as follows:

Jaw Surface	Suture Material
Smooth	9/0 - 11/0
0.2 mm pitch of serration	6/0 - 10/0
0.4 mm pitch of serration	4/0 - 6/0
0.5 mm pitch of serration	up to 3/0



BM001R 1/2

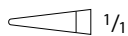

BM001R



BM002R 1/2

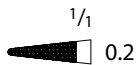

BM002R



BM004R 1/2

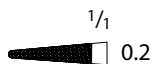

BM004R



BM005R 1/2

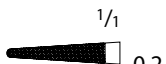

BM005R



US126 1/2



US126

DUROGRIP TC CASTROVIEJO Micro Needle Holder, Flat Handle

Catalog Number	Jaw	Length (in.)
BM001R	SMOOTH	5 3/4
BM002R	SERR	5 3/4
BM004R	SERR	7
BM005R	SERR	8 1/2

DUROGRIP TC SPENCER Coronary Needle Holder

Catalog Number	Jaw	Length (in.)
US126	SMOOTH	7



MB362R



DUROGRIP TC JACOBSON Needle Holder, Flat Handle W/O Catch

Catalog Number	Jaw	Length (in.)
MB362R	SERR	8 3/4

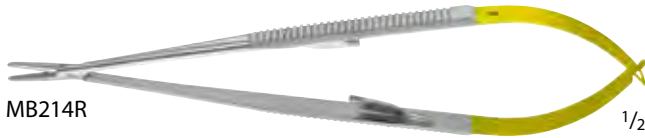

MB214R



DUROGRIP TC Micro Needle Holder, Flat Handle W/ Catch

Catalog Number	Jaw	Length (in.)
MB214R	SMOOTH	7 1/4



MB215R



DUROGRIP TC MILLS Vascular Needle Holder, Round Handle W/ Catch

Catalog Number	Jaw	Length (in.)
MB215R	SERR	8



FM388R-FM390R

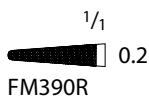
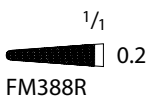

DUROGRIP TC Micro Needle Holder, Round Handle W/ Catch

Catalog Number	Jaw	Length (in.)
FM388R	SERR	7
FM390R	SERR	7 7/8



MG070R

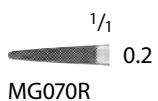

DUROGRIP TC GIANNINI Needle Holder

Catalog Number	Jaw	Length (in.)
MG070R	SERR	10 1/2



■ Dia Dust diamond dust coating ensures an even harder and more wear resistant surface on the inside of the jaws. The structure of the Dia Dust coating enables a reliable grip for fine needles, sutures, and tissue.



FM540R-FM544R



FM540R



FM541R-FM544R



FM545R-FM549R



FM545R-FM549R



FM550R-FM552R



FM550R-FM552R

Dia Dust Micro Needle Holder, Flat Handle W/ Catch

Catalog Number	Tip	Suture Size	Length (in.)
FM540R	STR	7/0 AND SMALLER	6 3/4
FM541R	STR	5/0 AND SMALLER	5 3/4
FM542R	STR	5/0 AND SMALLER	7 1/4
FM543R	STR	5/0 AND SMALLER	8 1/4
FM544R	STR	5/0 AND SMALLER	9

Dia Dust Micro Needle Holder, Flat Handle W/O Catch

Catalog Number	Tip	Suture Size	Length (in.)
FM545R	STR	7/0 AND SMALLER	6 3/4
FM546R	STR	5/0 AND SMALLER	5 3/4
FM547R	STR	5/0 AND SMALLER	7 1/4
FM548R	STR	5/0 AND SMALLER	8 1/4
FM549R	STR	5/0 AND SMALLER	9

Dia Dust Micro Needle Holder, Flat Knurled Handle W/ Catch

Catalog Number	Tip	Suture Size	Length (in.)
FM550R	STR	5/0 AND SMALLER	7 1/4
FM551R	STR	5/0 AND SMALLER	8 1/4
FM552R	STR	5/0 AND SMALLER	9



FM553R-FM555R



FM553R-FM555R

Dia Dust Micro Needle Holder, Flat Knurled Handle W/O Catch

Catalog Number	Tip	Suture Size	Length (in.)
FM553R	STR	5/0 AND SMALLER	7 1/4
FM554R	STR	5/0 AND SMALLER	8 1/4
FM555R	STR	5/0 AND SMALLER	9

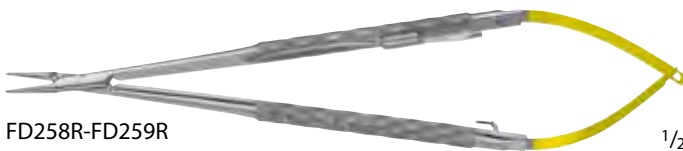

FD258R-FD259R



FD258R



FD259R

Dia Dust Micro Needle Holder, Golf Ball Handle Design

Catalog Number	Tip	Suture Size	Length (in.)
FD258R	STR	7/0 AND SMALLER	7
FD259R	CVD	7/0 AND SMALLER	7



FM218R-FM230R



FM218R-FM230R



FM221R-FM223R



FM221R-FM223R

Dia Dust Micro Needle Holder, Round Handle W/ Catch

Catalog Number	Tip	Suture Size	Length (in.)
FM218R	STR	4/0 AND SMALLER	7 1/4
FM228R	STR	4/0 AND SMALLER	8 1/4
FM230R	STR	4/0 AND SMALLER	9
FM221R	CVD	4/0 AND SMALLER	8 1/4
FM223R	CVD	4/0 AND SMALLER	9

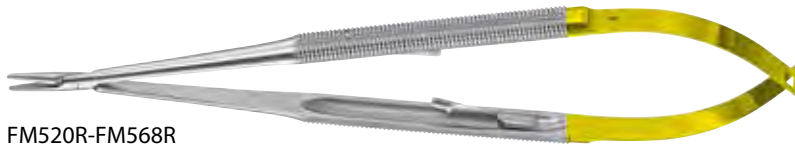

FM520R-FM568R



FM520R, FM521R, FM563R, FM565R, FM567R



FM522R, FM523R, FM564R, FM566R, FM568R

Dia Dust Micro Needle Holder, Round Handle W/ Catch

Catalog Number	Tip	Suture Size	Length (in.)
FM520R	STR	7/0 AND SMALLER	4 3/4
FM521R	STR	7/0 AND SMALLER	6 1/4
FM563R	STR	7/0 AND SMALLER	7 1/4
FM565R	STR	7/0 AND SMALLER	8 1/4
FM567R	STR	7/0 AND SMALLER	9
FM522R	STR	5/0 AND SMALLER	5 3/4
FM523R	STR	5/0 AND SMALLER	6 1/4
FM564R	STR	5/0 AND SMALLER	7 1/4
FM566R	STR	5/0 AND SMALLER	8 1/4
FM568R	STR	5/0 AND SMALLER	9



FM524R-FM533R



FM524R-FM527R, FM532R



FM528R-FM531R, FM533R

Dia Dust Micro Needle Holder, Round Handle W/O Catch

Catalog Number	Tip	Suture Size	Length (in.)
FM524R	STR	7/0 AND SMALLER	4 3/4
FM525R	STR	7/0 AND SMALLER	6 1/4
FM526R	STR	7/0 AND SMALLER	7 1/4
FM527R	STR	7/0 AND SMALLER	8 1/4
FM532R	STR	7/0 AND SMALLER	9
FM528R	STR	5/0 AND SMALLER	5 3/4
FM529R	STR	5/0 AND SMALLER	6 1/4
FM530R	STR	5/0 AND SMALLER	7 1/4
FM531R	STR	5/0 AND SMALLER	8 1/4
FM533R	STR	5/0 AND SMALLER	9



FM236R



1/2

Dia Dust Micro Needle Holder, Round Handle W/ Catch

Catalog Number	Tip	Suture Size	Length (in.)
FM236R	STR	5/0 AND SMALLER	8 1/4



FM276R



FM276R

Dia Dust Micro Needle Holder, Round Handle W/O Catch

Catalog Number	Tip	Suture Size	Length (in.)
FM276R	STR	5/0 AND SMALLER	8 1/4



FM534R-FM539R



FM534R-FM539R

Dia Dust Micro Needle Holder, Round Handle, Heavy, W/ Catch

Catalog Number	Tip	Description	Length (in.)
FM538R	STR	2/0 AND SMALLER	7 1/2
FM539R	STR	2/0 AND SMALLER	9
FM534R	STR	2/0 AND SMALLER	9 3/4



FM535R-FM537R



FM535R-FM537R

Dia Dust Micro Needle Holder, Round Handle, Heavy, W/O Catch

Catalog Number	Tip	Suture Size	Length (in.)
FM535R	STR	2/0 AND SMALLER	7 1/2
FM536R	STR	2/0 AND SMALLER	9
FM537R	STR	2/0 AND SMALLER	9 3/4



FM560R



FM560R

Dia Dust GLASSER Micro Needle Holder, Round Handle W/ Catch

Catalog Number	Tip	Suture Size	Length (in.)
FM560R	STR	5/0 AND SMALLER	5
FM561R	STR	5/0 AND SMALLER	7



FM561R



FM561R

Titanium Micro Instruments

- The extremely light Titanium material is an advantage for lengthy cardiac and vascular operations. This helps to carry on operating over longer time periods with minimum fatigue.
- The non-magnetic material makes working with particularly fine needles easier for you.
- Non-reflecting surface finish.
- Incomparable operating sensitivity: the golf ball handle design.



All needle holder jaws are coated with diamond dust coating. This coating ensures that the inner surfaces provide the best possible performance in hardness and wear resistance. The texture of the jaws greatly increases its surface area, allowing you to grasp fine needles, sutures and soft tissue safely and securely. The needle quickly aligns itself in an ideal position in the rough surface. This results in a perfect grip that quite simply prevents any needle slippage.



FM238T-FM260T



FM258T-FM260T



FM238T-FM240T

Titanium Micro Needle Holder, Golf Ball Handle Design W/ Catch

Catalog Number	Tip	Suture Size	Handle Color	Length (in.)
FM258T	STR	7/0 AND SMALLER	GREEN	7 1/4
FM259T	STR	7/0 AND SMALLER	GREEN	8 1/4
FM260T	STR	7/0 AND SMALLER	GREEN	9
FM238T	STR	5/0 AND SMALLER	BLUE	7 1/4
FM239T	STR	5/0 AND SMALLER	BLUE	8 1/4
FM240T	STR	5/0 AND SMALLER	BLUE	9



FM232T-FM254T



FM252T-FM254T



FM232T-FM234T

Titanium Micro Needle Holder, Golf Ball Handle Design W/O Catch

Catalog Number	Tip	Suture Size	Handle Color	Length (in.)
FM252T	STR	7/0 AND SMALLER	GREEN	7 1/4
FM253T	STR	7/0 AND SMALLER	GREEN	8 1/4
FM254T	STR	7/0 AND SMALLER	GREEN	9
FM232T	STR	5/0 AND SMALLER	BLUE	7 1/4
FM233T	STR	5/0 AND SMALLER	BLUE	8 1/4
FM234T	STR	5/0 AND SMALLER	BLUE	9

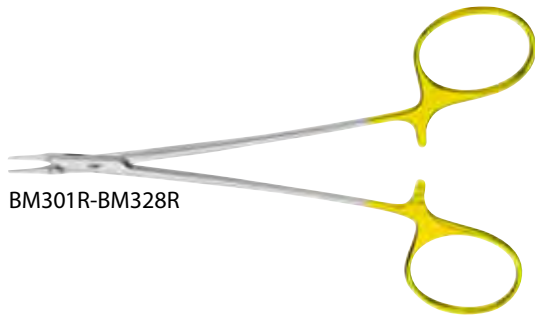

BM301R-BM328R



Dia Dust RYDER Needle Holder

Catalog Number	Tip	Suture Size	Length (in.)
BM301R	X-DEL	5/0 AND SMALLER	5 1/2
BM302R	X-DEL	5/0 AND SMALLER	7
BM325R	X-DEL	5/0 AND SMALLER	6 1/4
BM327R	X-DEL	5/0 AND SMALLER	8 3/4
BM328R	X-DEL	5/0 AND SMALLER	9 3/4

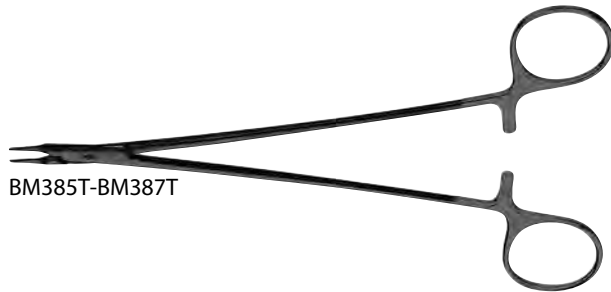

BM385T-BM387T



Titanium Dia Dust RYDER Needle Holder

Catalog Number	Tip	Suture Size	Length (in.)
BM385T	X-DEL	5/0 AND SMALLER	6 1/4
BM386T	X-DEL	5/0 AND SMALLER	7
BM387T	X-DEL	5/0 AND SMALLER	8 1/4

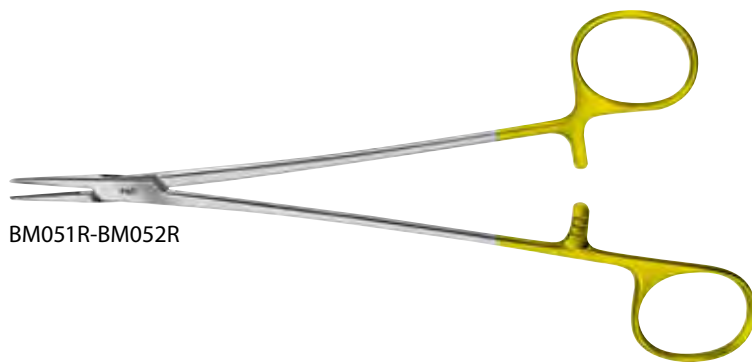

BM051R-BM052R



DUROGRIP TC DEBAKEY Needle Holder, Offset

Catalog Number	Jaw	Length (in.)
BM051R	SERR	7 3/4
BM052R	SERR	9 5/8

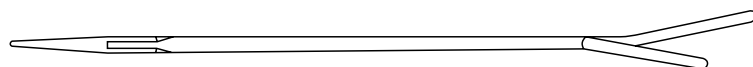

MG071R



DUROGRIP TC Microvascular Needle Holder

Catalog Number	Jaw	Length (in.)
MG071R	SERR	6

DUROGRIP TC DEBAKEY Needle Holder

Catalog Number	Tip	Jaw	Length (in.)
BM032R	DEL	SERR	6
BM033R	DEL	SERR	6 1/2
BM035R	DEL	SERR	7
BM034R	DEL	SERR	8 1/4
BM036R	DEL	SERR	9
BM037R	DEL	SERR	10 1/4
BM038R	DEL	SERR	12
BM063R	X-DEL	SERR	6 1/2
BM064R	X-DEL	SERR	8 1/4
BM040R	X-DEL	SERR	12

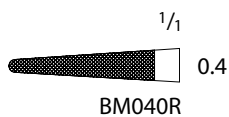
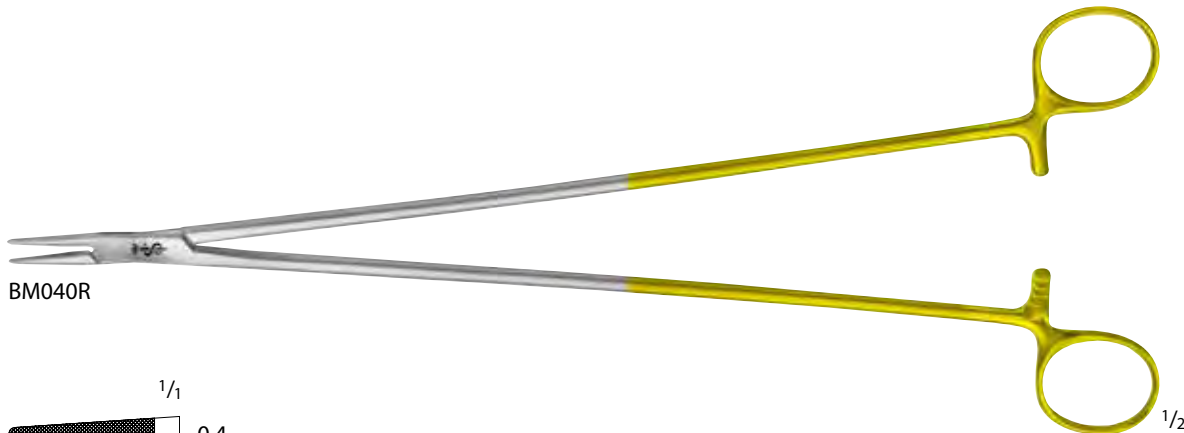
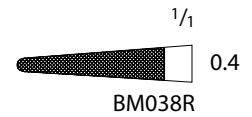
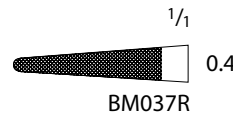
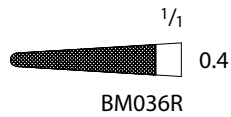
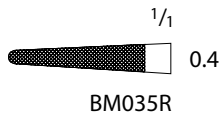
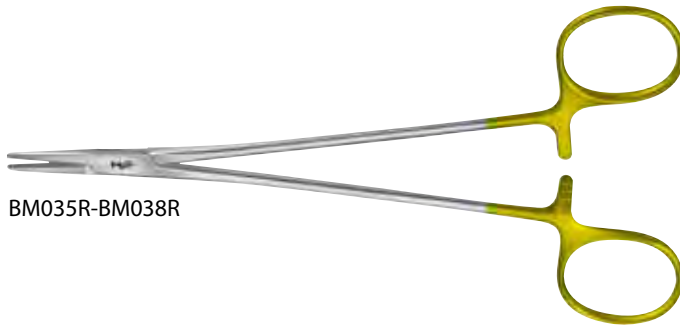
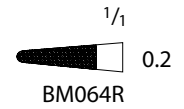
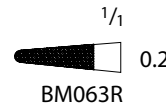
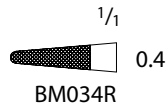
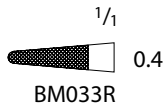
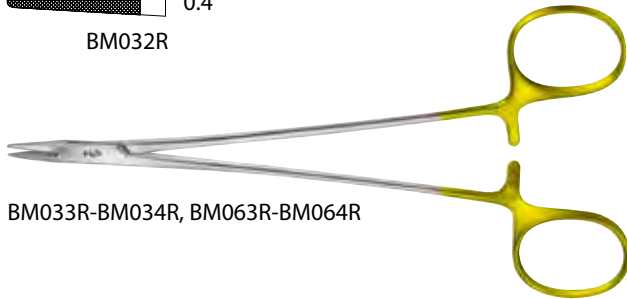
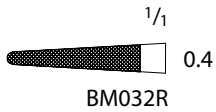

Let Us know if you could not find what you are looking for

DUROGRIP TC RYDER Needle Holder

Catalog Number	Tip	Jaw	Length (in.)
BM054R	X-DEL	SERR	5 1/4
BM055R	X-DEL	SERR	6 1/8
BM056R	X-DEL	SERR	6 7/8
BM057R	X-DEL	SERR	8 1/4
BM058R	X-DEL	SERR	9
BM044R	DEL	SERR	5 1/4
BM045R	DEL	SERR	6 7/8
BM046R	DEL	SERR	7 3/4
BM047R	DEL	SERR	10 1/2
BM074R	DEL	SMOOTH	6
BM075R	DEL	SMOOTH	7
BM076R	DEL	SMOOTH	8 7/8

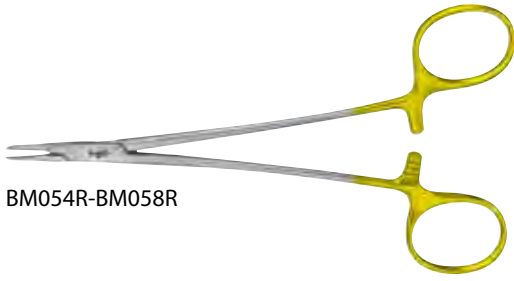

BM054R-BM058R

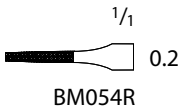

BM054R

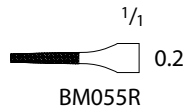

BM055R

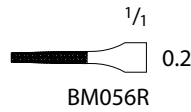

BM056R

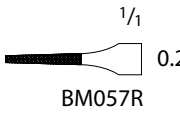

BM057R

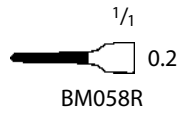

BM058R

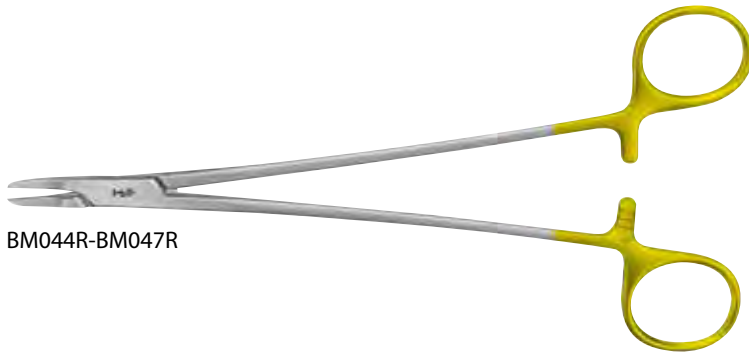

BM044R-BM047R

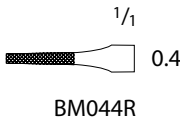

BM044R

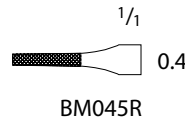

BM045R

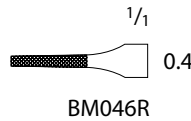

BM046R

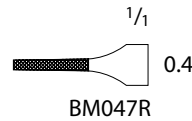

BM047R

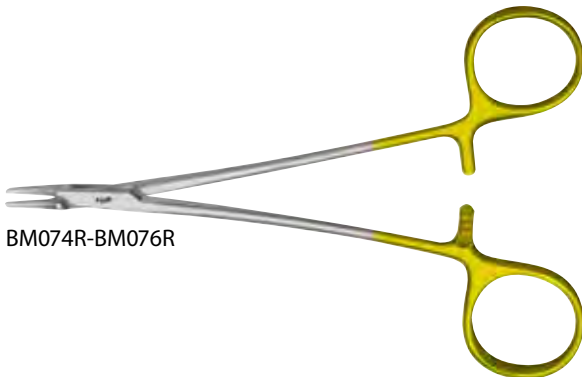

BM074R-BM076R



BM074R

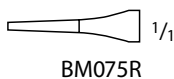

BM075R

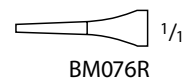

BM076R

Let Us know if you could not find what you are looking for

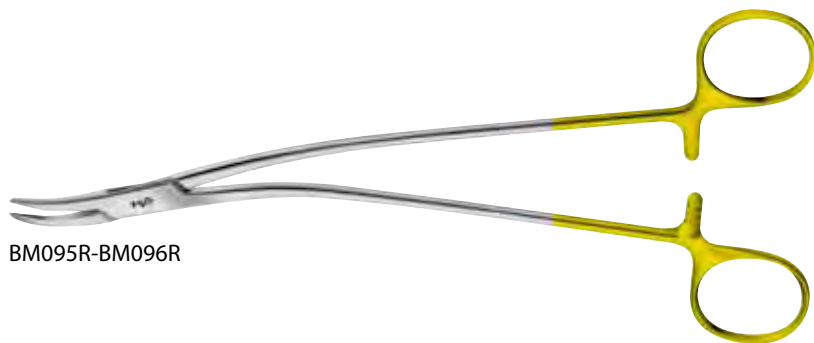

BM095R-BM096R

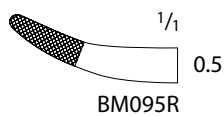

BM095R

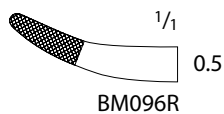

BM096R

DUROGRIP TC STRATTE Needle Holder

Catalog Number	Tip	Jaw	Length (in.)
BM095R	CVD	SERR	8 1/4
BM096R	CVD	SERR	9

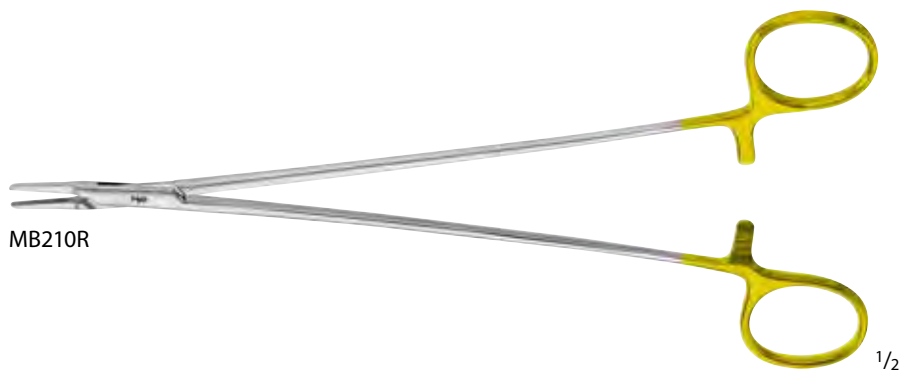

MB210R



MB210R

DUROGRIP TC COOLEY Intracardiac
 Needle Holder

Catalog Number	Jaw	Length (in.)
MB210R	SERR	9

DEBAKEY Tissue Forceps

Catalog Number	Tip Size (mm)	Length (in.)
MB062R	2	14
MB915R	2	16
MB916R	3	16



MB062R-MB916R



MG440R



WHEELER Vessel Forceps

Catalog Number	Tip	Length (in.)
MG440R	SERR	6



BD228R-BD230R

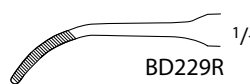
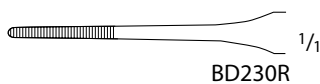
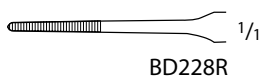

GERALD Dressing Forceps, Delicate

Catalog Number	Tip	Jaw	Length (in.)
BD228R	STR	SERR	6 7/8
BD230R	STR	SERR	9
BD229R	CVD	SERR	6 7/8



BD662R-BD664R

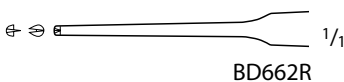

GERALD Tissue Forceps, Delicate

Catalog Number	Tip	Teeth	Length (in.)
BD662R	STR	1 x 2	6 7/8
BD664R	STR	1 x 2	9
BD663R	CVD	1 x 2	6 7/8



BD750R, MB795R, MG078

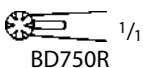

SELMAN Tissue Forceps

Catalog Number	Length (in.)
BD750R	6 1/8
MB795R	7 7/8
MG078R	9 3/4



BD801R

1/2



BD801R



MG428R

1/2

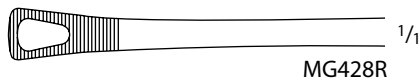

MG428R

TUTTLE-SINGLEY Lung Forceps

Catalog Number	Length (in.)
BD801R	9
MG428R	14

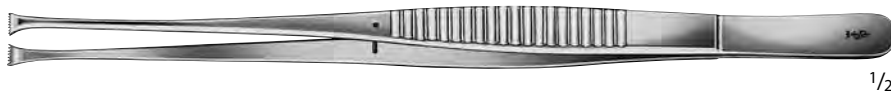

BD802R

1/2

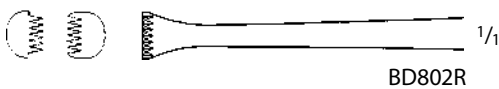

BD802R

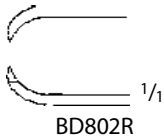

BD802R

NELSON Lung Forceps

Catalog Number	Length (in.)
BD802R	9



BD710R-BD712R



BD710R

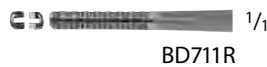

BD711R

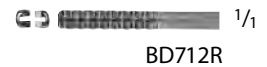

BD712R

RESANO Cardiac Valve Forceps

Catalog Number	Tip Size (mm)	Length (in.)
BD710R	2.5	7
BD711R	2.5	8
BD712R	2.5	9



FB397R-FB399R



FB397R



FB398R

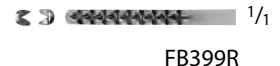

FB399R

RESANO Cardiac Valve Forceps

Catalog Number	Tip Size (mm)	Length (in.)
FB397R	2	7
FB398R	2	9
FB399R	2	11 3/4

GERALD Micro Forceps, Flat Handle

Catalog Number	Tip	Length (in.)
BD190R	SERR	7
BD197R	SERR	9 3/4



BD190R-BD197R

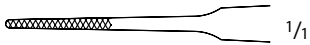

BD190R-BD197R



BD191R-BD195R

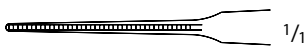

BD191R-BD195R

GERALD Micro Forceps, Flat Handle

Catalog Number	Tip	Length (in.)
BD191R	DEBAKEY	7
BD195R	DEBAKEY	7 7/8



BD338R



BD338R



BD264R



BD264R

Micro Suture Forceps, W/ Platform

Catalog Number	Tip Size (mm)	Length (in.)
BD338R	0.3	4 3/4
BD264R	0.5	7 1/4



FM033R



FM033R



FM034R



FM034R

MUELLER Micro Forceps, Plastic Handle

Catalog Number	Teeth	Length (in.)
FM033R	-	6 1/4
FM034R	1 x 2	6 1/4



FM035R



FM035R



FM036R



FM036R



FM063R

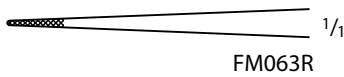

FM063R



FM590R-FM591R

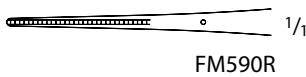

FM590R



FM591R



FM592R-FM600R



FM592R



FM600R



BD154R

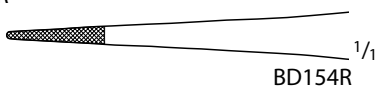

BD154R

MUELLER Micro Ring Forceps, Plastic Handle

Catalog Number	Diam. of Ring (mm)	Length (in.)
FM035R	1.2	6 1/4

MUELLER Micro Forceps, Plastic Handle, W/ Platform

Catalog Number	Length (in.)
FM036R	6 1/4

Micro Forceps, Round Handle

Catalog Number	Tip	Counter-balance	Length (in.)
FM063R	CROSS-SERR	NO	7 7/8

Micro Forceps, Round Handle

Catalog Number	Tip	Counter-balance	Length (in.)
FM590R	DEBAKEY	NO	7 1/4
FM591R	DEBAKEY	NO	8 1/4
FM592R	DEBAKEY	YES	7 1/4
FM600R	DEBAKEY	YES	8 1/4

DUOGRIP TC (POTTS-SMITH) Thumb Forceps

Catalog Number	Tip	Length (in.)
BD154R	X-SERR	5 3/4



■ The Dia Dust diamond dust coating ensures an even harder and more wear resistant surface on the inside of the jaws. The structure of the Dia Dust coating enables a reliable grip for fine needles, sutures, and tissue.



BD192R-BD193R

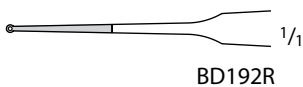

BD192R

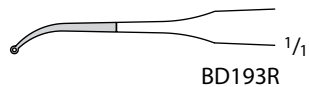

BD193R

Dia Dust GERALD Micro Ring Forceps,
Flat Handle

Catalog Number	Diam. of Ring (mm)	Tip	Length (in.)
BD192R	1.0	STR	7
BD193R	1.0	CVD	7



BD194R-BD196R

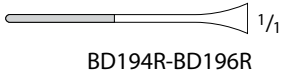

BD194R-BD196R

Dia Dust GERALD Micro Forceps, Flat Handle

Catalog Number	Tip	Tip Size (mm)	Length (in.)
BD194R	STR	1.0	7
BD196R	STR	1.0	7 7/8



BD200R-BD201R



BD200R-BD201R

Dia Dust THUMB Forceps, Flat Handle

Catalog Number	Tip	Tip Size (mm)	Length (in.)
BD200R	STR	1.0	7
BD201R	STR	1.0	8 1/4



FD253R



FD253R

Dia Dust Micro Forceps W/ Platform

Catalog Number	Tip	Counter-balance	Length (in.)
FD253R	STR	NO	7



FM053R-FM054R



FM053R-FM054R

Dia Dust Micro Ring Forceps, Round Handle

Catalog Number	Diam. of Ring (mm)	Tip	Counter-balance	Length (in.)
FM053R	2.5	STR	NO	7
FM054R	2.5	STR	NO	7 7/8



FM597R-FM598R

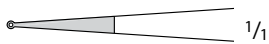

FM597R-FM598R

Dia Dust Micro Ring Forceps, Round Handle

Catalog Number	Diam. of Ring (mm)	Tip	Counter-balance	Length (in.)
FM597R	1.0	STR	NO	7 1/4
FM598R	1.0	STR	NO	8 1/4
FM587R	1.0	CVD	NO	7 1/4



FM587R



FM587R



FM582R-FM584R



FM582R-FM584R

Dia Dust Micro Ring Forceps, W/ Platform, Round Handle

Catalog Number	Diam. of Ring (mm)	Tip	Counter-balance	Length (in.)
FM582R	1.0	STR	NO	7 1/4
FM584R	1.0	STR	NO	8 1/4



FM586R-FM588R



FM586R-FM588R

Dia Dust Micro Forceps, W/ Platform, Round Handle

Catalog Number	Tip	Counter-balance	Length (in.)
FM586R	STR	NO	7 1/4
FM588R	STR	NO	8 1/4

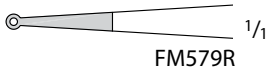

FM571R-FM595R

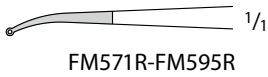

Dia Dust Micro Ring Forceps, Round Handle

Catalog Number	Diam. of Ring (mm)	Tip	Counter-balance	Length (in.)
FM570R	1.0	STR	YES	6
FM572R	1.0	STR	YES	7 1/4
FM574R	1.0	STR	YES	8 1/4
FM576R	1.0	STR	YES	9
FM596R	1.0	STR	YES	9 3/4
FM579R	2.0	STR	YES	7 1/4
FM571R	1.0	CVD	YES	6
FM573R	1.0	CVD	YES	7 1/4
FM575R	1.0	CVD	YES	8 1/4
FM577R	1.0	CVD	YES	9
FM595R	1.0	CVD	YES	9 3/4



FM578R-FM599R

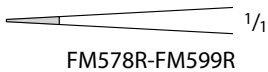

FM581R-FM593R



Dia Dust Micro Forceps, W/ Platform, Round Handle

Catalog Number	Tip	Counter-balance	Length (in.)
FM578R	STR	YES	6
FM580R	STR	YES	7 1/4
FM599R	STR	YES	8 1/4
FM594R	STR	YES	9 3/4
FM581R	CVD	YES	6
FM583R	CVD	YES	7 1/4
FM585R	CVD	YES	8 1/4
FM593R	CVD	YES	9 3/4

Titanium Micro Instruments

- The extremely light Titanium material is an advantage for lengthy cardiac and vascular operations. This helps to carry on operating over longer time periods with minimum fatigue.
- Non-reflecting surface finish - for optimal glare reduction.
- The golf ball handle design - gives incomparable operating sensitivity.
-



All titanium forceps jaws are coated with diamond dust coating. This coating ensures that the inner surfaces provide the best possible performance in hardness and wear resistance. The texture of the jaws greatly increases its surface area, allowing you to grasp sutures and soft tissue safely and securely.



FM317T-FM319T

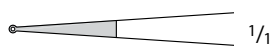

FM317T-FM319T



FM327T-FM329T



FM327T-FM329T



FM337T-FM339T



FM337T-FM339T

Titanium Micro Ring Forceps, Golf Ball Handle

Catalog Number	Diam. of Ring (mm)	Tip	Handle Color	Counter-balance	Length (in.)
FM317T	1.0	DIA DUST	BLUE	NO	7 1/4
FM318T	1.0	DIA DUST	BLUE	NO	8 1/4
FM319T	1.0	DIA DUST	BLUE	NO	9

Titanium Micro Forceps, W/ Platform, Golf Ball Handle

Catalog Number	Tip	Handle Color	Counter-balance	Length (in.)
FM327T	DIA DUST	GREEN	NO	7 1/4
FM328T	DIA DUST	GREEN	NO	8 1/4
FM329T	DIA DUST	GREEN	NO	9

Titanium Micro Forceps, Golf Ball Handle

Catalog Number	Tip	Handle Color	Counter-balance	Length (in.)
FM337T	DEBAKEY	PURPLE	NO	7 1/4
FM338T	DEBAKEY	PURPLE	NO	8 1/4
FM339T	DEBAKEY	PURPLE	NO	9

Titanium Standard Forceps

- Non-reflecting surface finish.
- Fatigue-free lightness.
- Blue handle for definite identification of an Aesculap Titanium Instrument.



FB387T-FB389T



FB387T-FB389T



FB390T-FB392T



FB390T-FB392T



BD221T



BD221T



BD514T



BD514T



BD516T



BD516T

Titanium DEBAKEY Atraumatic Forceps

Catalog Number	Tip Size (mm)	Length (in.)
FB387T	1.5	5 3/4
FB388T	1.5	7 3/4
FB389T	1.5	9 1/2
FB390T	2.5	5 3/4
FB391T	2.5	7 3/4
FB392T	2.5	9 1/2

Titanium Micro ADSON Dissecting Forceps

Catalog Number	Tip	Length (in.)
BD221T	SERR	4 3/4

Titanium Micro ADSON Tissue Forceps, Delicate

Catalog Number	Tip	Teeth	Length (in.)
BD514T	SERR	1 x 2	4 3/4

Titanium Micro ADSON Tissue Forceps

Catalog Number	Tip	Teeth	Length (in.)
BD516T	SERR	1 x 2	4 3/4



BD227T



BD227T

Titanium GERALD Dissecting Forceps, Delicate

Catalog Number	Tip	Length (in.)
BD227T	SERR	6 3/4



BD657T

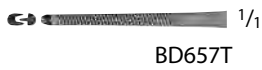

BD657T

Titanium GERALD Tissue Forceps

Catalog Number	Tip	Teeth	Length (in.)
BD657T	SERR	1 x 2	6 3/4



BD715T



BD715T

Titanium RESANO Grasping Forceps

Catalog Number	Tip	Length (in.)
BD715T	SERR	9

Titanium Ringhandled Instruments

- Non-reflecting surface finish.
- Fatigue-free lightness.
- Blue rings for definite identification of an Aesculap Titanium Instrument.

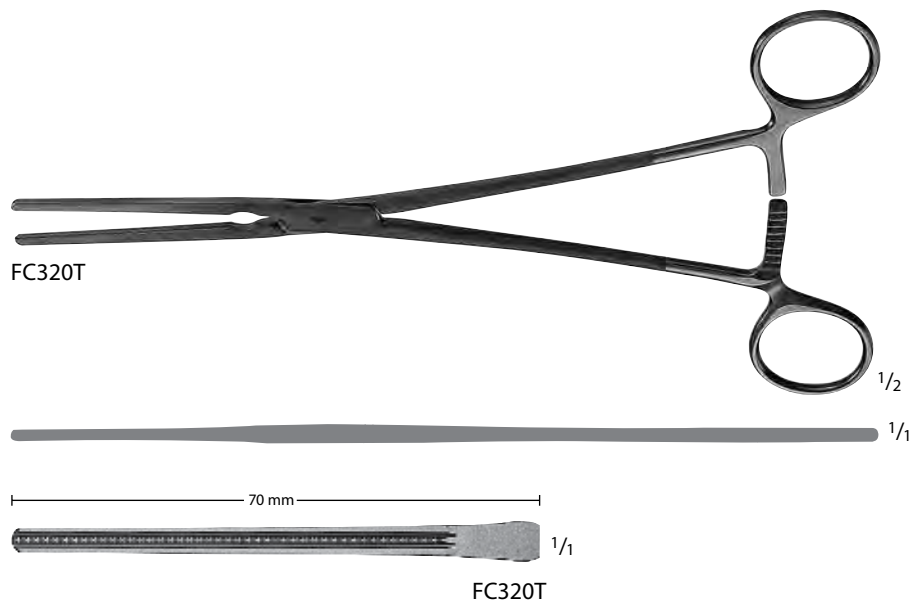

Titanium DEBAKEY Atraumatic Vascular Clamp

Catalog Number	Jaw	Jaw Length (mm)	Length (in.)
FC320T	STR	70	9

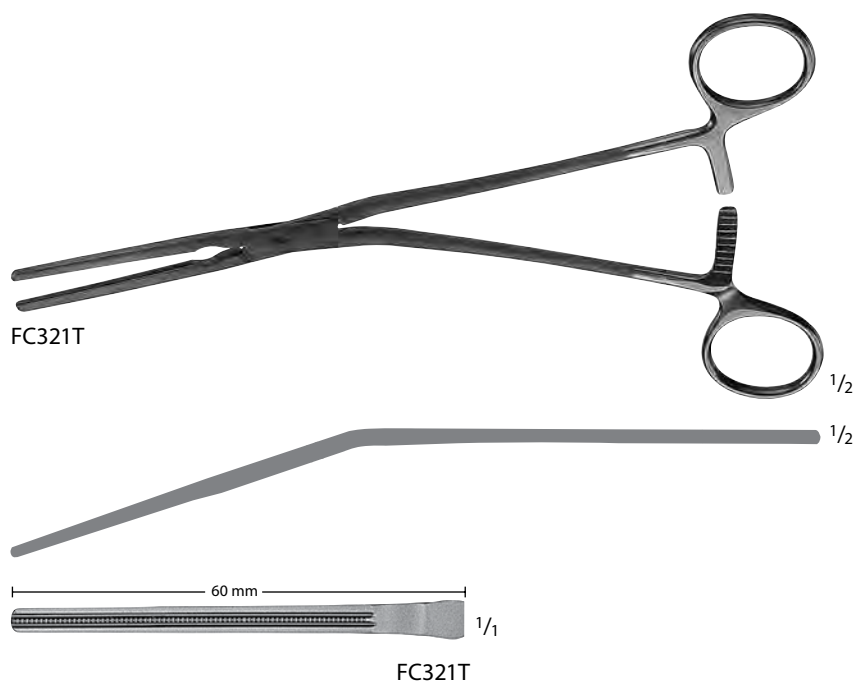

Titanium DEBAKEY Atraumatic Vascular Clamp

Catalog Number	Jaw	Jaw Length (mm)	Shaft	Length (in.)
FC321T	STR	60	ANG	8 1/2



FC322T-FC323T

Titanium DEBAKEY Atraumatic
 Vascular Clamp

Catalog Number	Jaw	Jaw Length (mm)	Length (in.)
FC322T	CVD	70	8 7/8
FC323T	CVD	75	9 5/8

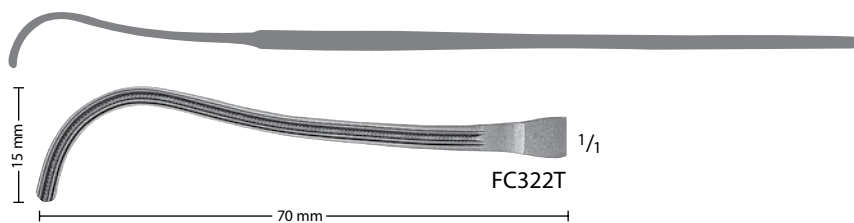

FC322T

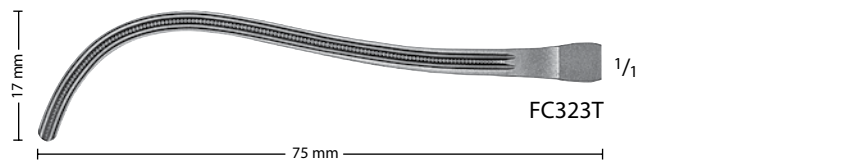

FC323T



FC324T-FC325T

Titanium GLOVER Atraumatic Vascular
 Clamp

Catalog Number	Jaw	Jaw Length (mm)	Length (in.)
FC324T	CVD	60	8 3/4
FC325T	CVD	80	10 5/8

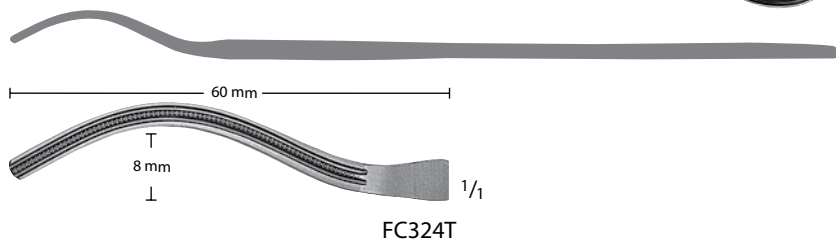

FC324T

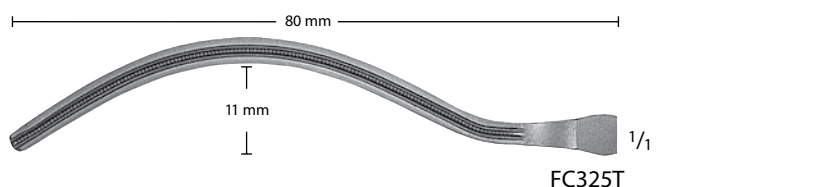

FC325T

Titanium LAMBERT-KAY Atraumatic
Vascular Clamp

Catalog Number	Jaw Angle	Jaw Length (mm)	Shaft	Length (in.)
FC326T	MULTI	45	ANG	7 3/4

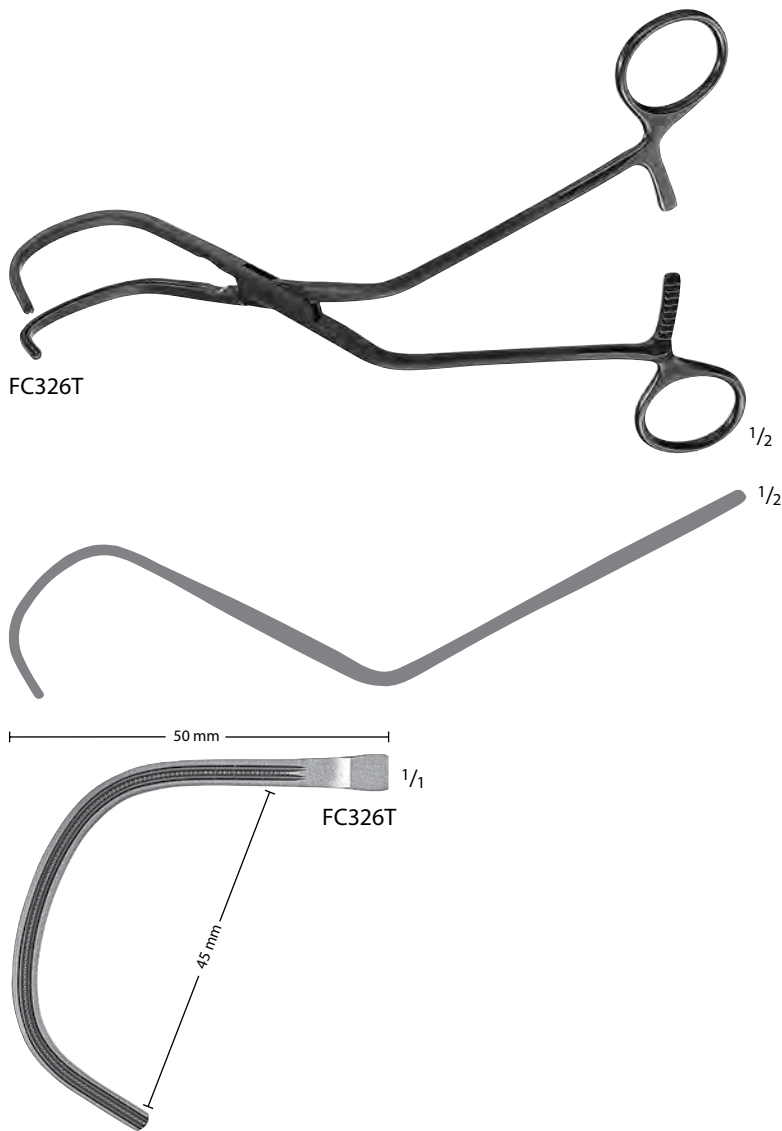

Titanium DEBAKEY Atraumatic
Vascular Clamp

Catalog Number	Jaw	Length (in.)
FC327T	SLIGHT-CVD	12 1/4
FC328T	SLIGHT-CVD	12 1/2



FC327T-FC328T

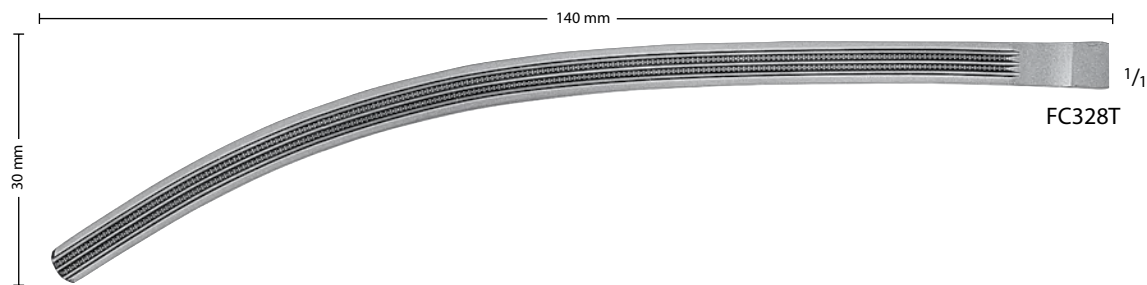
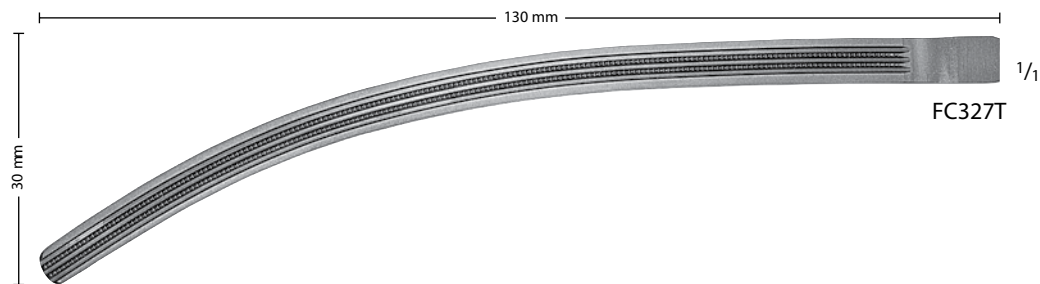

Titanium DEBAKEY Atraumatic
Vascular Clamp

Catalog Number	Jaw	Shaft	Length (in.)
FC331T	CVD	ANG	7 3/4
FC330T	ANG	7	



FC330T-FC331T

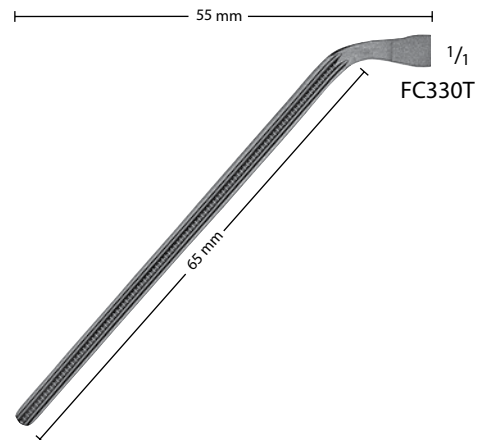
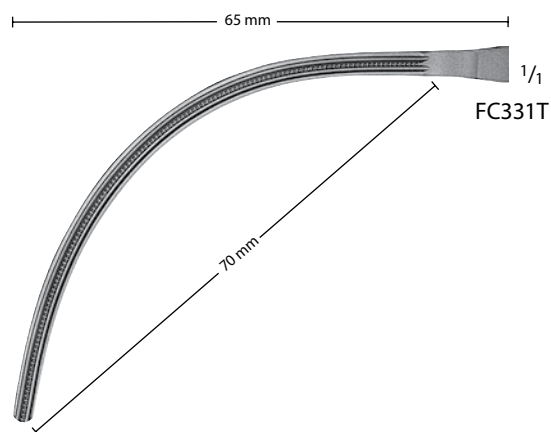

Titanium DEBAKEY Atraumatic
Vascular Clamp

Catalog Number	Jaw	Length (in.)
FC329T	HEAVY-CVD	10 1/4



FC329T

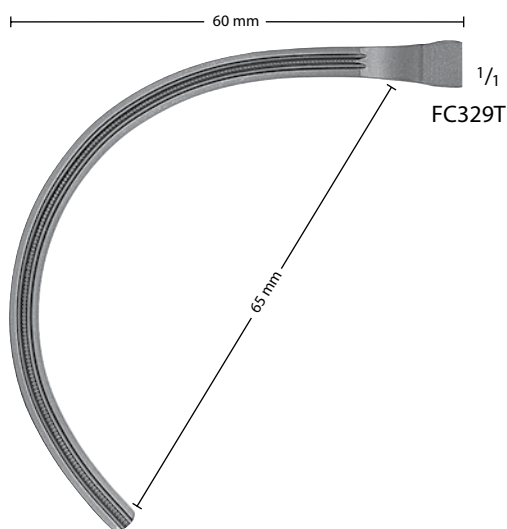

Titanium DEBAKEY Atraumatic
 Vascular Clamp

Catalog Number	Jaw	Shaft	Length (in.)
FC332T	ANG	ANG	9 1/2
FC333T	ANG	ANG	8 1/2



FC332T-FC333T

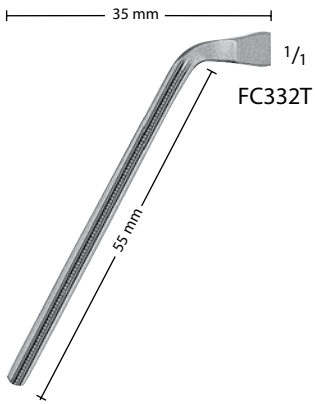



FC334T-FC336T

Titanium DEBAKEY-SATINSKY
Atraumatic Vascular Clamp

Catalog Number	Jaw Angle	Shaft	Length (in.)
FC336T	MULTI	ANG	7 7/8
FC335T	MULTI	ANG	9 5/8
FC334T	MULTI	ANG	9 3/4

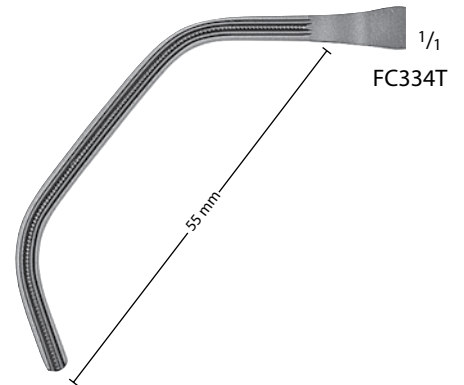
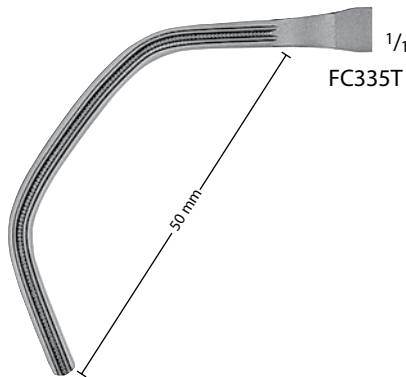
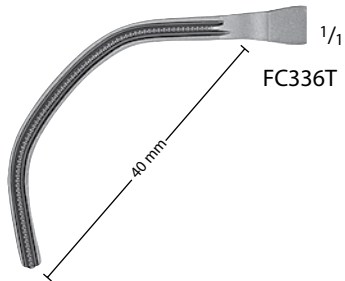

Titanium DEBAKEY Atraumatic
Pediatric Vascular Clamp

Catalog Number	Jaw Angle	Length (in.)
FC337T	STR	4 1/4
FC338T	30°	4 1/4
FC339T	45°	4 1/4
FC340T	60°	4 1/4
FC341T	MULTI	3 3/4
FC342T	MULTI	4
FC343T	MULTI	4

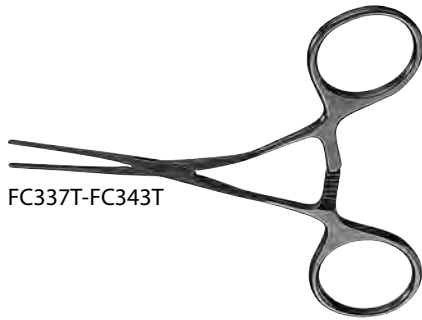

FC337T-FC343T



30 mm
1/1
FC337T

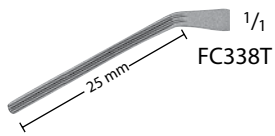

1/1
FC338T
25 mm

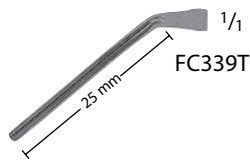

1/1
FC339T
25 mm

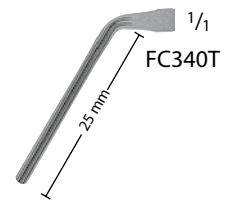

1/1
FC340T
25 mm

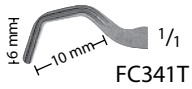

1/1
FC341T
10 mm



1/1
FC342T
10 mm

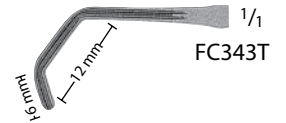

1/1
FC343T
12 mm

Let Us know if you could not find what you are looking for

Chest Tube Passer

Catalog Number	Description	Length (in.)
MG578R	W/O RATCHET	9 3/4
MG589R	W/O RATCHET	14
MG588R	W/ RATCHET	9 3/4



MG578R, MG589R



MG578R, MG589R



MG588R



MG588R

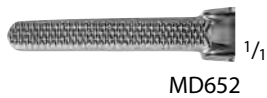
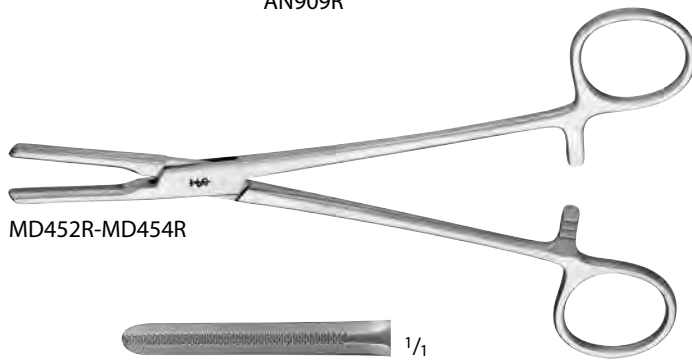

Tubing Clamp

Catalog Number	Jaw	Length (in.)
AN909R	SMOOTH	6 1/2
MD452R	SERR	6
MD453R	SERR	7
MD454R	SERR	7 7/8

Tubing Clamp, W/ Guard

Catalog Number	Jaw	Length (in.)
MD652	SERR	6
MD653	SERR	7
MD654	SERR	7 7/8

SAROT Forceps, Delicate

Catalog Number	Teeth	Length (in.)
BH224R	-	9 1/2
BH234R	1 x 2	9 1/2

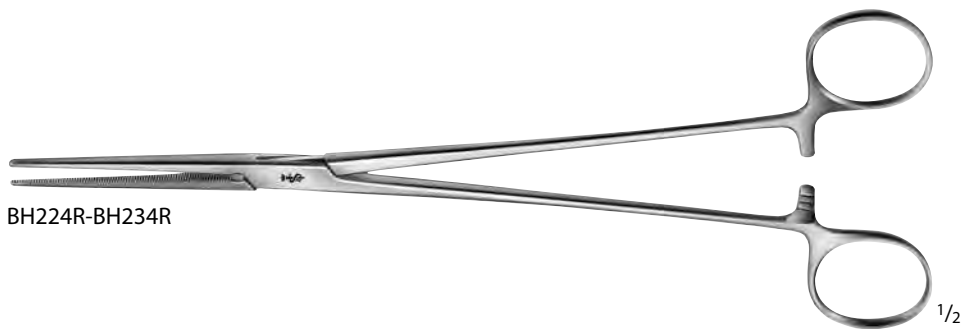

BH224R-BH234R



BH224R



BH234R

CRAFOORD Forceps, Delicate

Catalog Number	Jaw	Length (in.)
BH225R	CVD	9 5/8

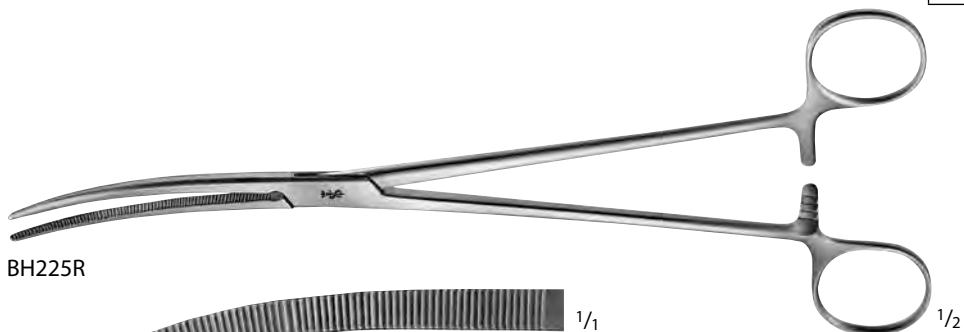

BH225R



BH225R

HOLLE Forceps, Delicate

Catalog Number	Jaw	Length (in.)
BJ037R	CVD	5 3/4
BJ038R	CVD	7 1/4
BJ039R	CVD	9 1/4

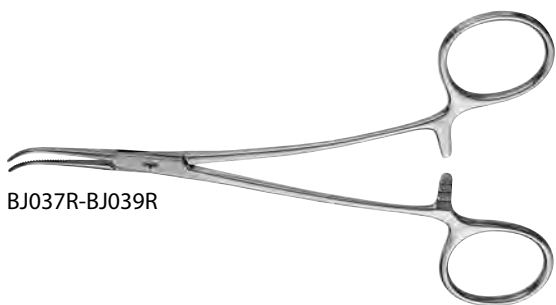

BJ037R-BJ039R



BJ037R



BJ038R



BJ039R

COLLER Artery Forceps

Catalog Number	Jaw Angle	Length (in.)
MG421R	90°	9 1/2

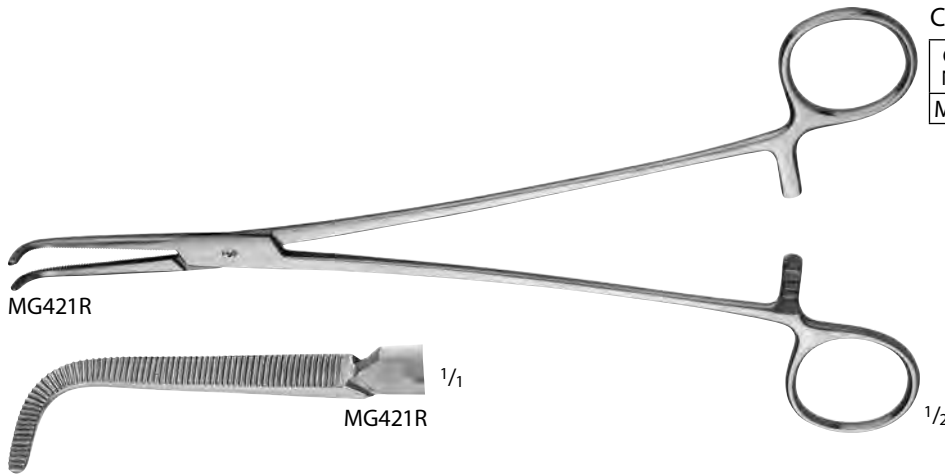

SAROT Intrathoracic Artery Forceps

Catalog Number	Jaw	Length (in.)
BH226R	SLIGHT-CVD	9 3/4

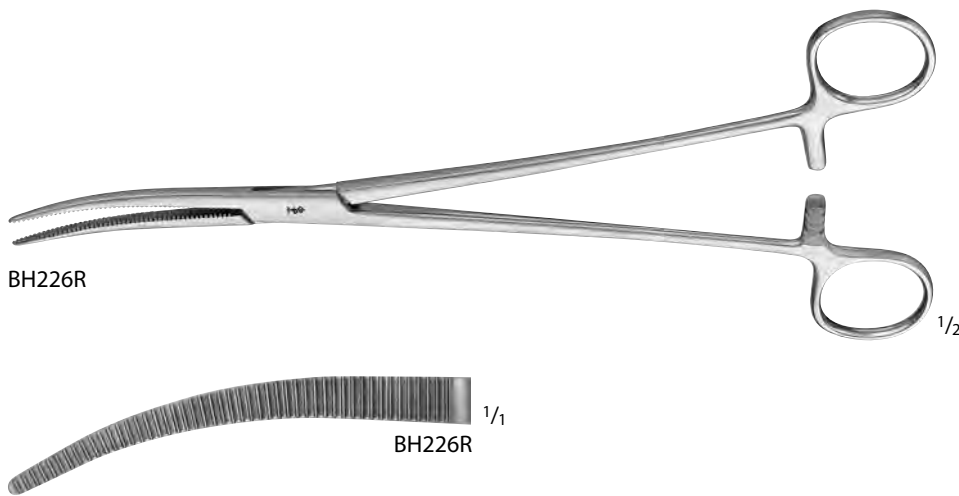

JULIAN Thoracic Artery Forceps

Catalog Number	Jaw	Length (in.)
BH233R	CVD	9 1/4

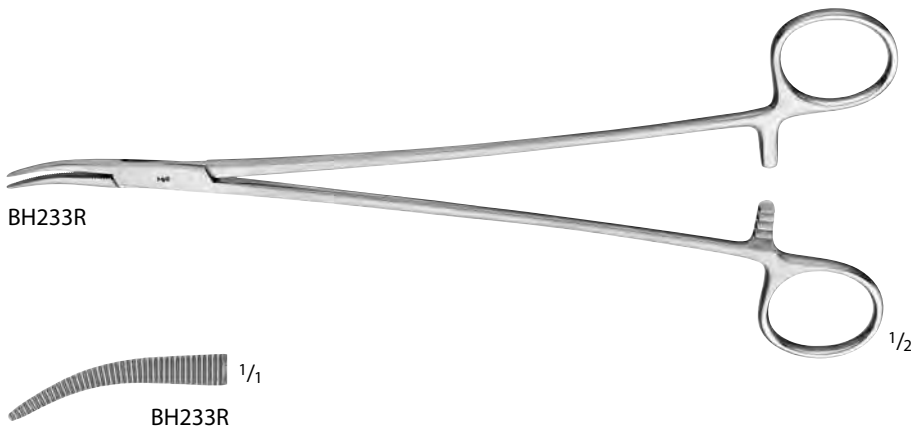



MB056R

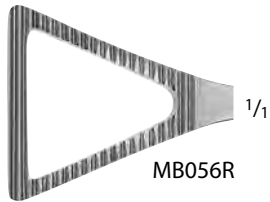

MB056R

LOVELACE Lung Forceps

Catalog Number	Length (in.)
MB056R	8



FB930R

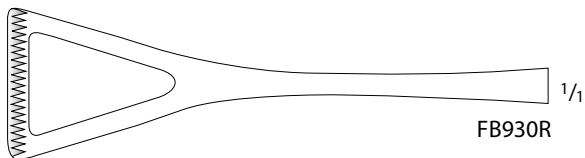

FB930R

DUVAL Lung Forceps

Catalog Number	Length (in.)
FB930R	9



MB057R



MB057R

BABCOCK Thoracic Tissue Forceps

Catalog Number	Length (in.)
MB057R	9 1/2

Thoracoscopy Forceps

Catalog Number	Jaw	Jaw Length (mm)	Length (in.)
MB458R	STR, LONG	158	12 1/2
MB296R	CVD, LONG	158	12 1/4

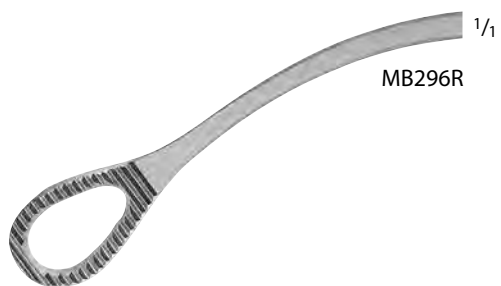

ROCHESTER-OCHSNER Artery Forceps

Catalog Number	Jaw	Teeth	Length (in.)
MB172R	STR	1 x 2	14

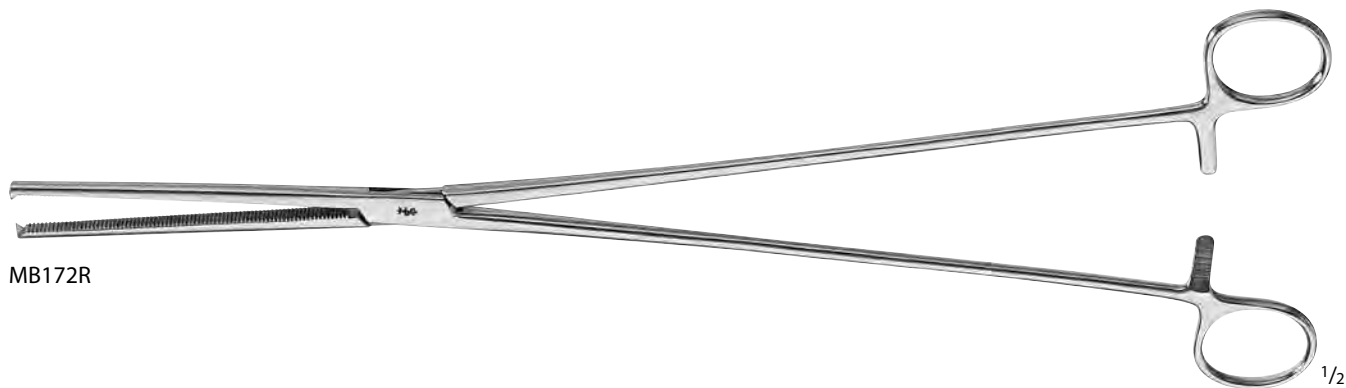

MB172R

MB172R

CARMALT Artery Forceps, Longitudinal Serrations

Catalog Number	Jaw	Length (in.)
MB182R	SLIGHT-CVD	12

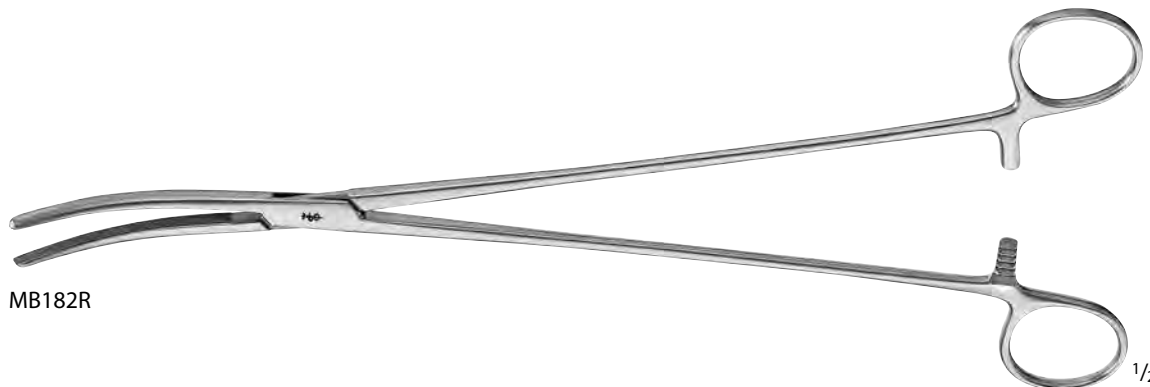

MB182R

MB182R

COOLEY Bronchus Clamp

Catalog Number	Jaw	Length (in.)
MG449R	ANG	8 1/4

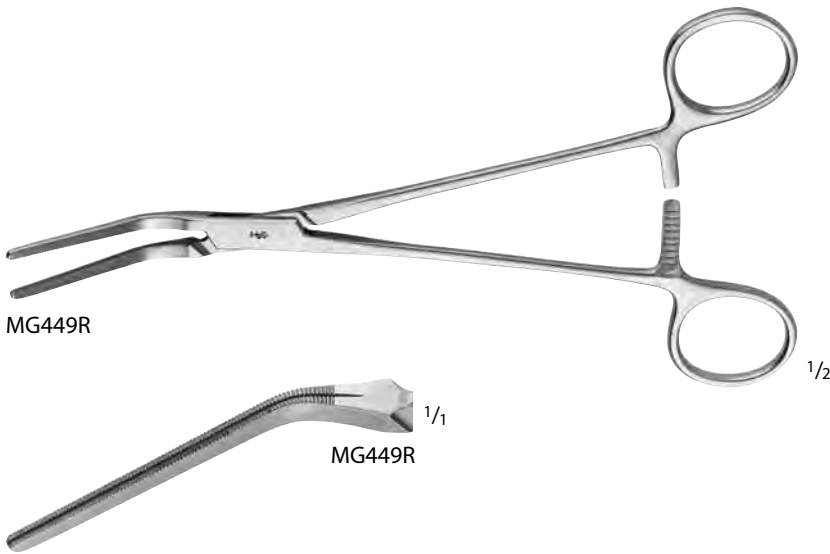

Bronchus Clamp, Longitudinal Serrations

Catalog Number	Jaw Angle	Jaw Length (mm)	Length (in.)
FB954R	90°	60	9
FB955R	90°	80	9

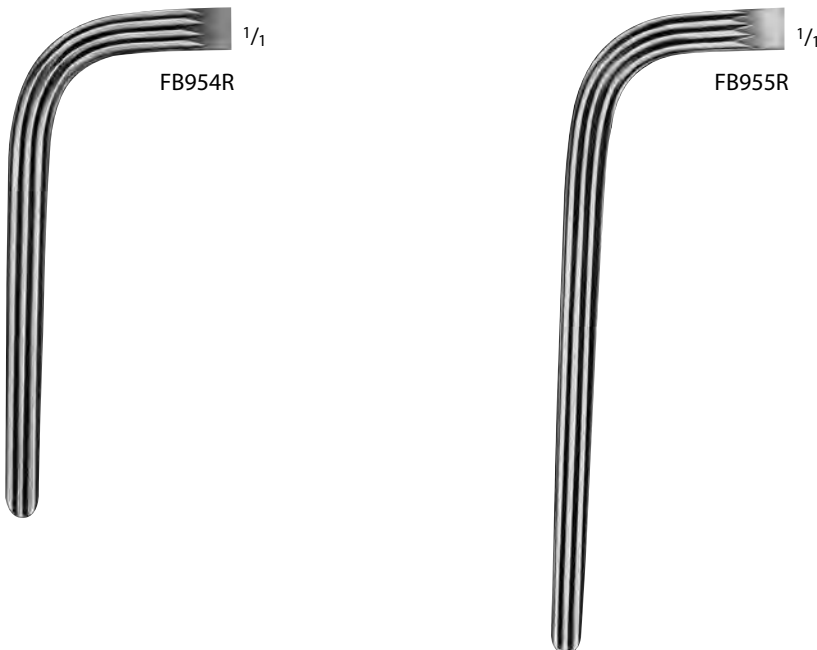
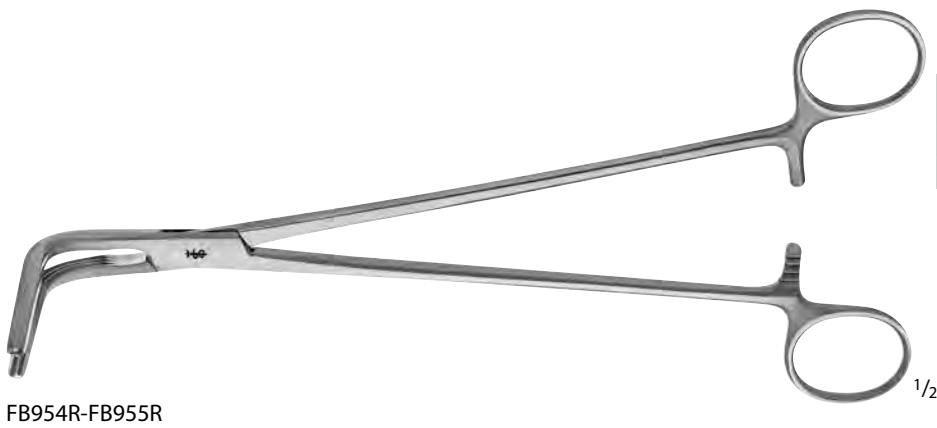



MB608R-MB610R

SAROT Bronchus Clamp

Catalog Number	Jaw	Length (in.)
MB610R	CVD-RIGHT	9
MB608R	CVD-LEFT	9



MB610R

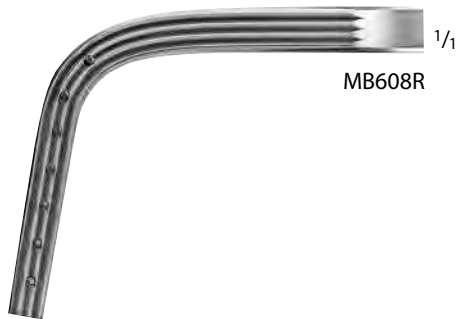

MB608R

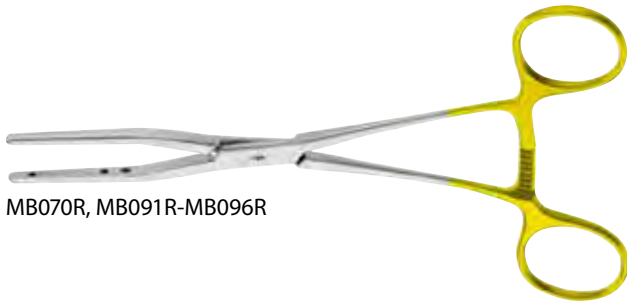

MB070R, MB091R-MB096R

FOGARTY-Type Clamp

Catalog Number	Jaw	Jaw Length (mm)	Length (in.)
MB091R	STR	33	6 1/2
MB070R	STR	61	11 5/8
MB096R	STR	86	12 1/4
MB092R	ANG	33	4 5/8
MB094R	ANG	61	8 1/2
MB093R	ANG	61	8 3/4
MB095R	ANG	86	9 1/4



MB092R



MB093R



MB094R



MB095R



MB091R



MB070R



MB096R



MB097R



MB097R

FOGARTY-Type Spring Clip Applicator

Catalog Number	Teeth	Length (in.)
MB097R	1 x 2	7 1/4



FB950R

PRICE-THOMAS Bronchus Forceps

Catalog Number	Length (in.)
FB950R	8 7/8

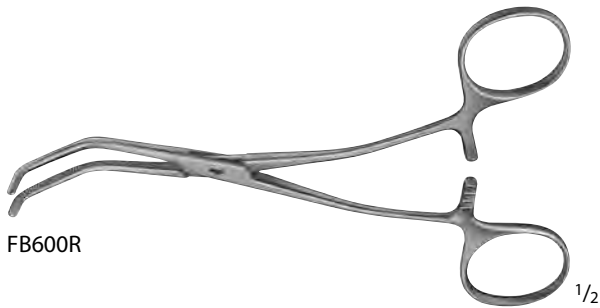
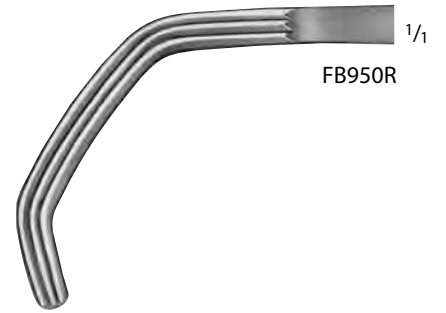

FB600R

Baby SATINSKY Vena Cava Clamp

Catalog Number	Jaw	Length (in.)
FB600R	X-SERR	6

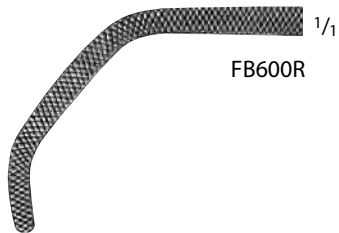

FB600R

SATINSKY Vena Cava Clamp

Catalog Number	Jaw	Jaw Size	Shaft	Length (in.)
FB602R	ANG, X-SERR	LARGE	STR	10 1/2
FB604R	ANG, X-SERR	SMALL	LIGHT-CVD	10 1/2
FB605R	ANG, X-SERR	LARGE	LIGHT-CVD	10 1/2

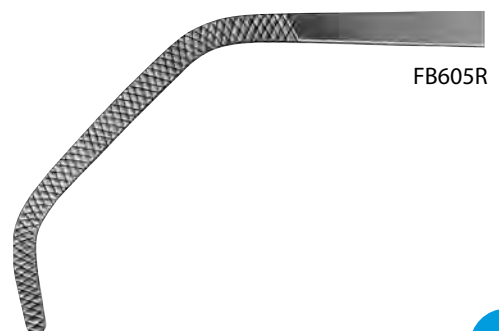
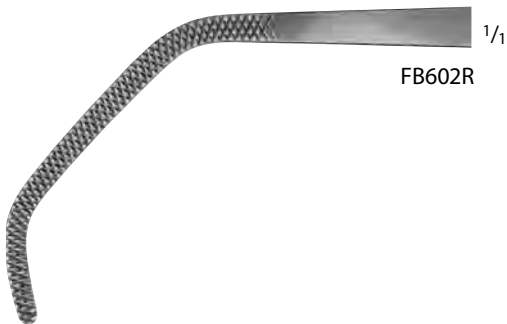
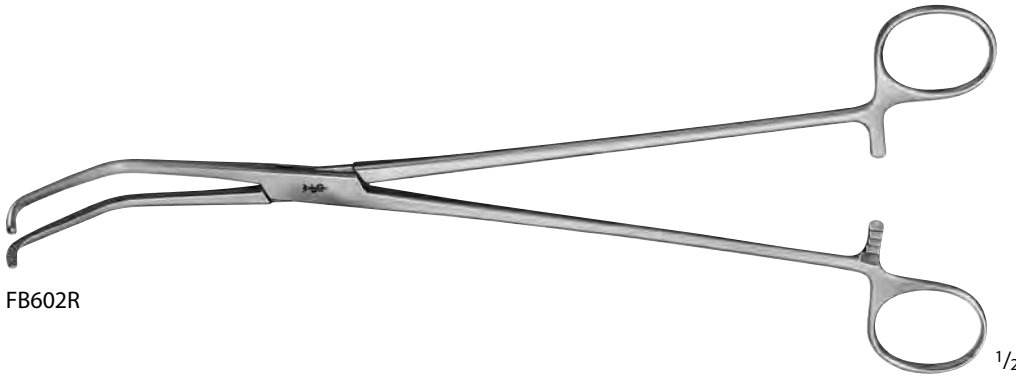



FB633R

CRAFOORD-SELLORS Coarctation
 Clamp, Longitudinal Serrations

Catalog Number	Jaw	Length (in.)
FB633R	SLIGHT-CVD	9 1/2



FB633R



FB634R-FB635R

CRAFOORD Auricle Clamp, Longitudinal
 Serrations

Catalog Number	Jaw	Length (in.)
FB634R	MEDIUM-CVD	9 1/2
FB635R	HEAVY-CVD	9 1/2

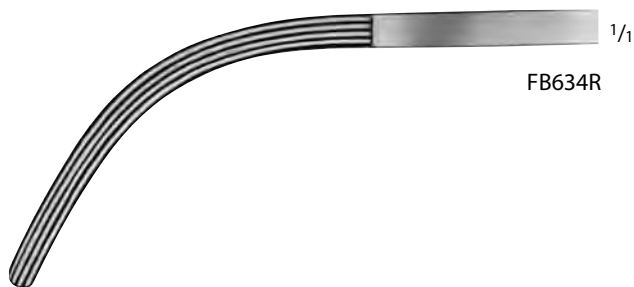

FB634R



FB635R

SEMB Suture Forceps

Catalog Number	Jaw	Length (in.)
FB961R	HEAVY-CVD	9 1/2



FB961R

1/2



1/1

FB961R

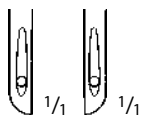

1/1

1/1

HALLMAN Tunnelling Forceps

Catalog Number	Jaw	Length (in.)
MG075R	SERR RING	13 1/2



MG075R

1/2



1/1

MG075R

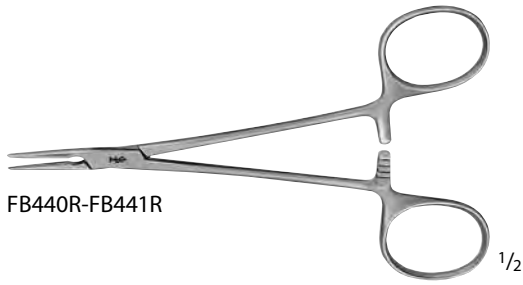

FB440R-FB441R



FB440R



FB441R

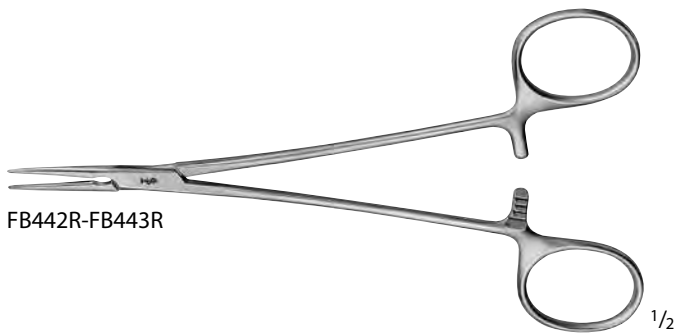

FB442R-FB443R



FB442R



FB443R

DEBAKEY Mosquito Atraumatic
 Forceps

Catalog Number	Jaw	Jaw Length (mm)	Length (in.)
FB440R	STR	20	5
FB442R	STR	27	6 1/2
FB441R	CVD	20	5
FB443R	CVD	27	6 1/2

DEBAKEY-BAINBRIDGE Atraumatic
 Forceps

Catalog Number	Jaw	Jaw Length (mm)	Length (in.)
FB446R	STR	40	6 1/8
FB448R	STR	65	7
FB447R	CVD	40	6 1/8
FB449R	CVD	65	7

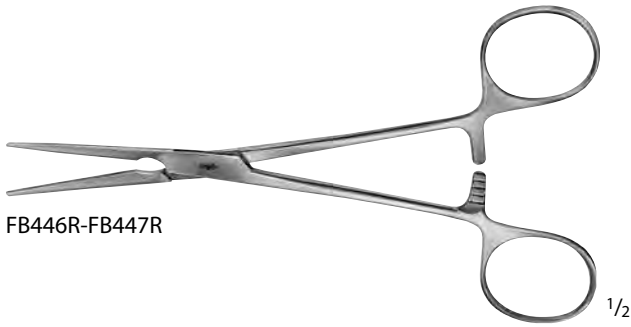

FB446R-FB447R



FB446R



FB447R



FB448R-FB449R



FB448R



FB449R

DEBAKEY-HARKEN Atraumatic
 Vascular Clamps

Catalog Number	Tip Size (#)	Jaw	Jaw Length (mm)	Length (in.)
FB521R	1	CVD	86	10
FB522R	2	CVD	86	9 5/8
FB523R	3	CVD	86	9 5/8
FB524R	4	CVD	86	9 3/4



FB521R-FB524R



FB521R

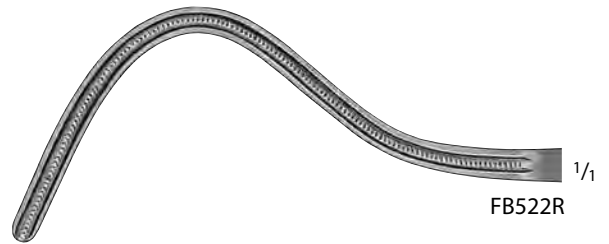

FB522R

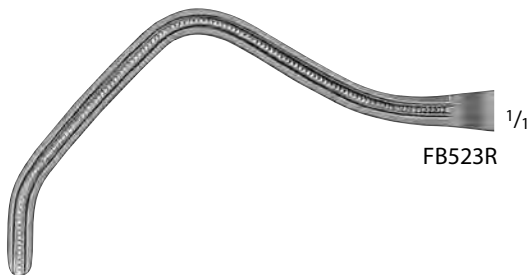

FB523R

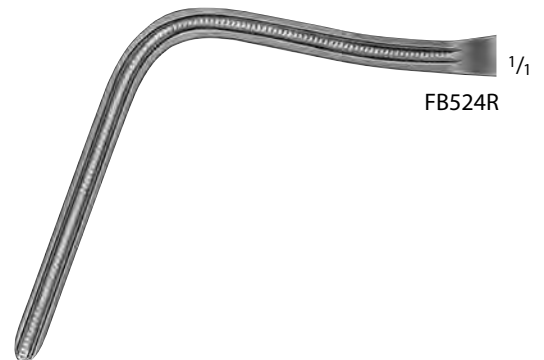

FB524R

DEBAKEY-PEAN Atraumatic Forceps

Catalog Number	Jaw	Jaw Length (mm)	Length (in.)
FB526R	STR	60	7 7/8
FB532R	STR	89	10 1/2
FB534R	STR	99	11
FB527R	CVD	60	7 7/8
FB533R	CVD	89	10 1/4
FB535R	CVD	99	10 3/4



FB526R-FB535R



FB526R



FB532R



FB534R



FB527R



FB533R

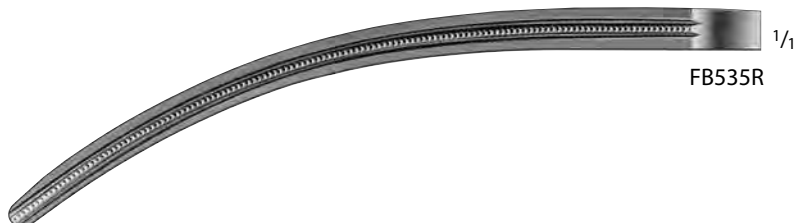

FB535R



FB540R-FB541R, FB543R-FB544R

DEBAKEY Atraumatic Ring Handle
 Bulldog Clamp

Catalog Number	Jaw Angle	Jaw Length (mm)	Length (in.)
FB540R	STR	53	5 1/8
FB541R	CVD	53	5
FB542R	CVD*	53	5
FB543R	45°	53	5
FB544R	90°	53	4 1/8

*Instrument is S-Shaped

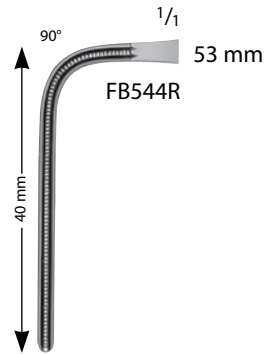
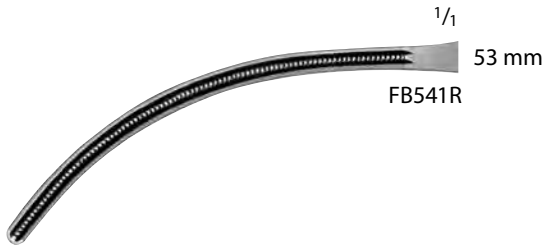
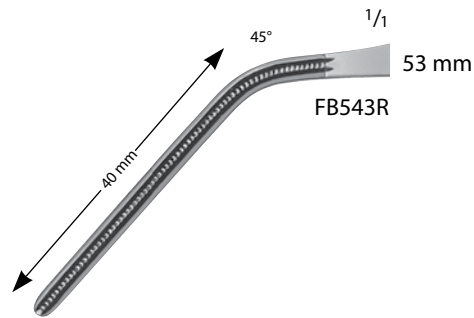

FB542R

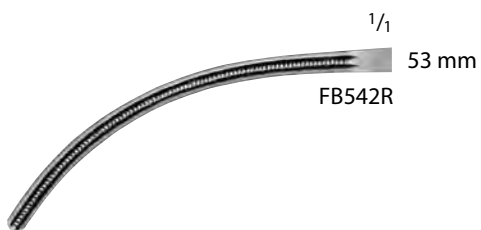

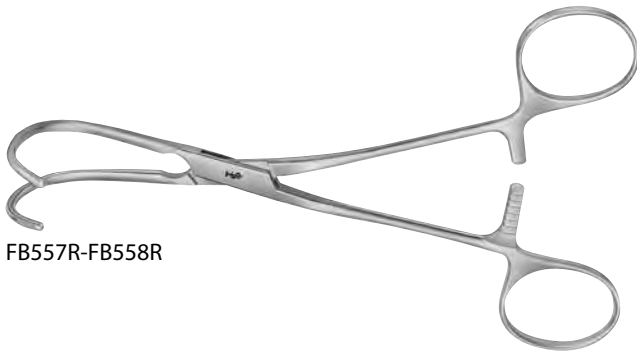

FB557R-FB558R

DEBAKEY Atraumatic Multi-Purpose
 Clamp, Curved

Catalog Number	Jaw Length (mm)	Length (in.)
FB557R	31	6 1/2
FB558R	40	6 3/4

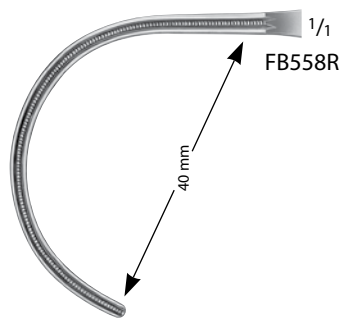
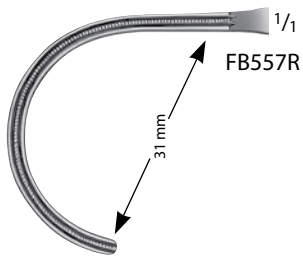

FB563R

COOLEY Atraumatic Pediatric
 Vascular Clamp

Catalog Number	Jaw Angle	Jaw Length (mm)	Length (in.)
FB563R	MULTI	24	6 1/4

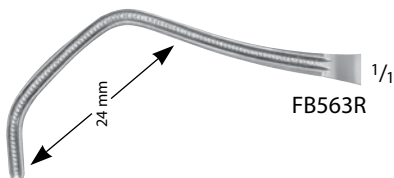

COOLEY Atraumatic Pediatric
 Vascular Clamp (continued)

Catalog Number	Jaw Angle	Jaw Length (mm)	Length (in.)
FB741R	25°	38	5 3/4
FB567R	30°	30	6 1/2
FB568R	60°	30	6 1/4
FB569R	90°	30	6
FB570R	MULTI	90	7 7/8

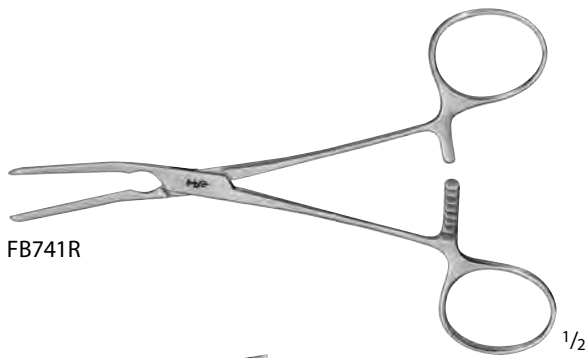

FB741R

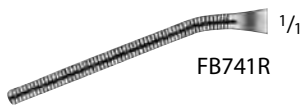

FB741R

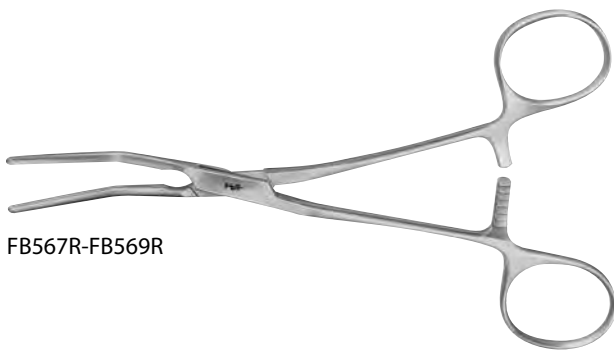

FB567R-FB569R

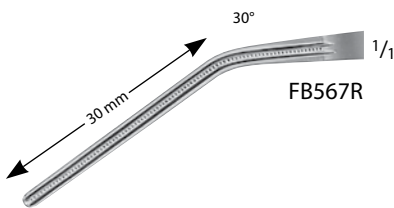

FB567R

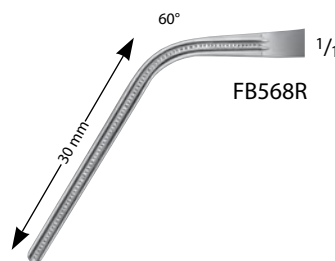

FB568R

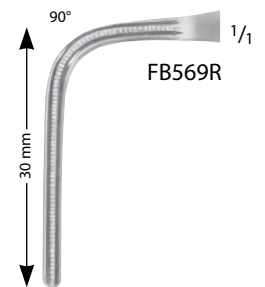

FB569R

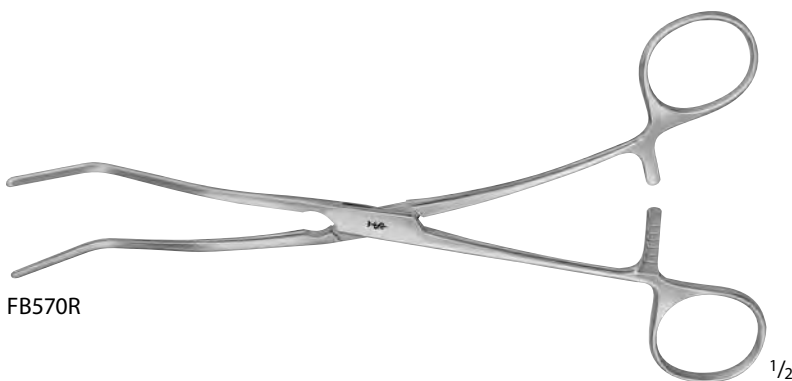

FB570R



FB570R

Let Us know if you could not find what you are looking for

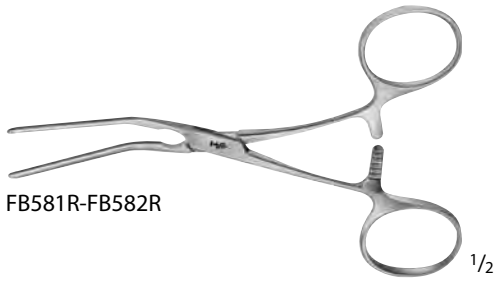

FB581R-FB582R

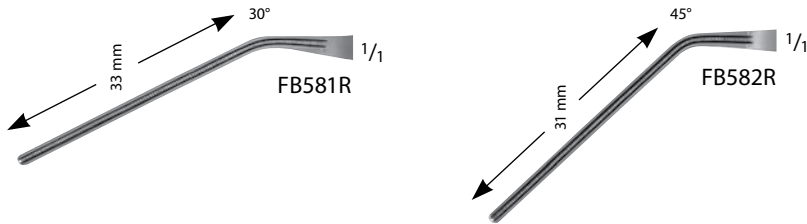

CASTANEDA Atraumatic Neonatal
 Clamp, Angled

Catalog Number	Jaw Angle	Jaw Length (mm)	Length (in.)
FB581R	30°	33	4 3/4
FB582R	45°	31	4 3/4



FB590R-FB593R

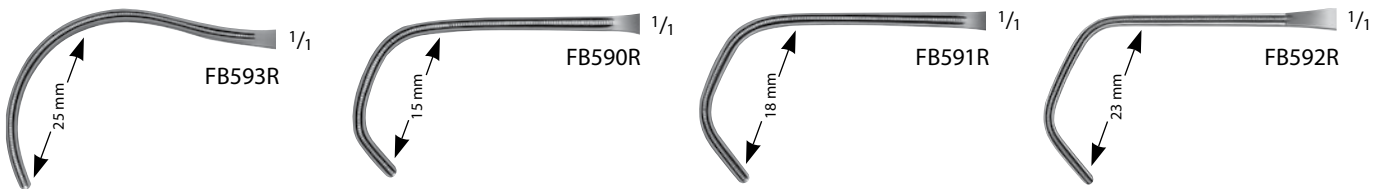

CASTANEDA Atraumatic Neonatal
 Clamp

Catalog Number	Jaw Angle	Jaw Length (mm)	Length (in.)
FB593R	CVD	15	6 1/8
FB590R	MULTI	18	6 1/8
FB591R	MULTI	23	6 1/8
FB592R	MULTI	25	6 1/8

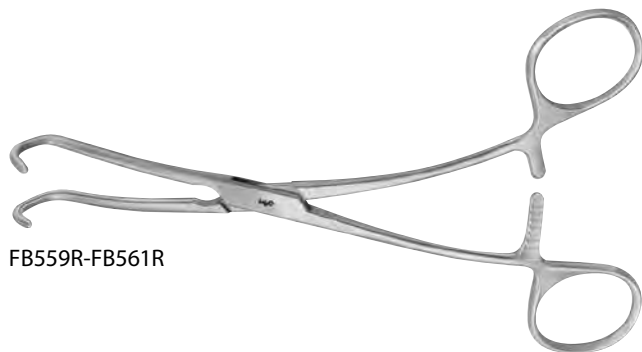

FB559R-FB561R

DERRA Atraumatic Pediatric Forceps

Catalog Number	Jaw Angle	Jaw Length (mm)	Length (in.)
FB559R	MULTI	16	6 3/4
FB560R	MULTI	20	6 3/4
FB561R	MULTI	26	6 7/8



FB559R



FB560R

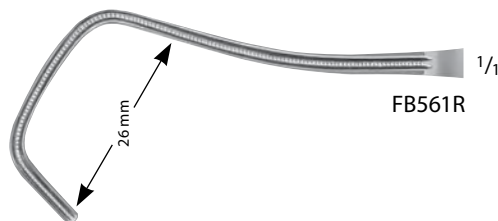

FB561R

LELAND-JONES Atraumatic Peripheral
 Clamp

Catalog Number	Jaw Angle	Jaw Length (mm)	Length (in.)
FB469R	STR	77	7 3/4
FB468R	15°	65	7 1/2
FB467R	30°	65	7 1/2

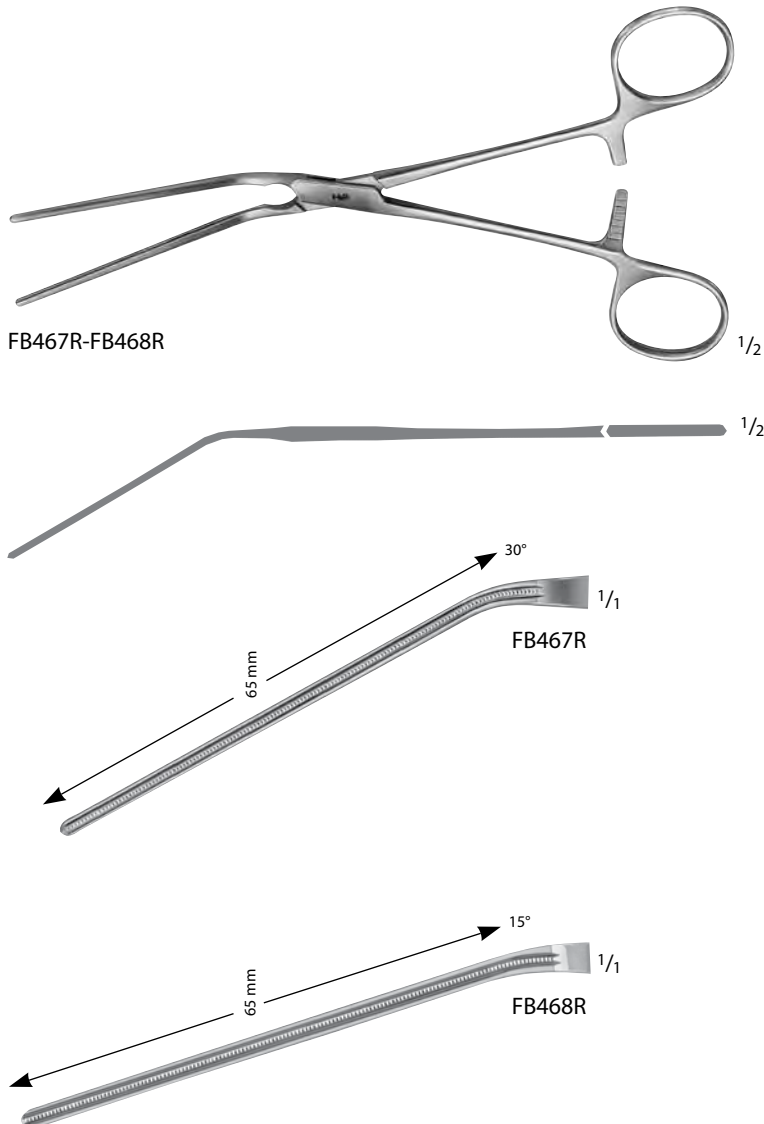
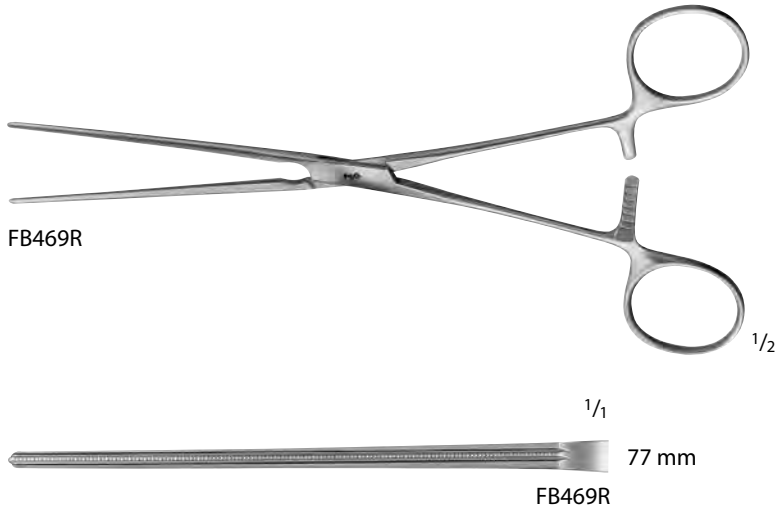

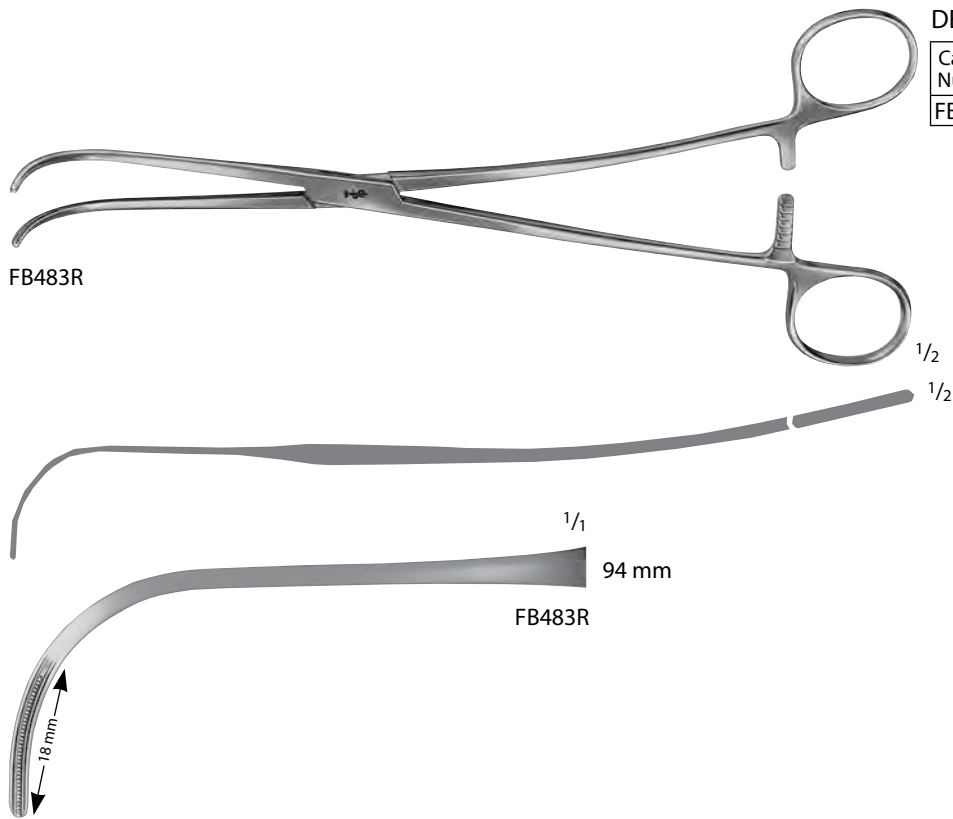

DEBAKEY Atraumatic Suture Forceps

Catalog Number	Jaw	Jaw Length (mm)	Shaft	Length (in.)
FB483R	CVD	94	CVD	9 1/2

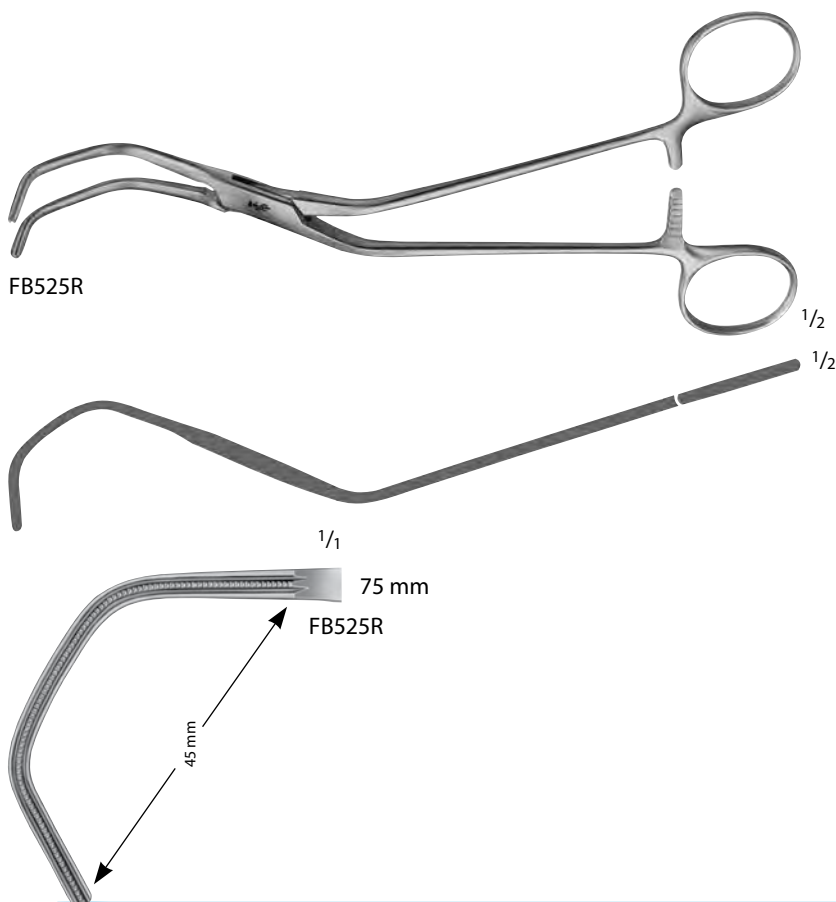

DIETHRICH Atraumatic Aortic Clamp

Catalog Number	Jaw Angle	Jaw Length (mm)	Length (in.)
FB525R	MULTI	45	8 1/4

DEBAKEY Atraumatic Forceps

Catalog Number	Jaw	Jaw Length (mm)	Length (in.)
FB484R	C-CURVE	77	7 1/2
FB498R	C-CURVE	51	8 1/4
FB485R	D-CURVE	80	9
FB499R	D-CURVE	75	9



FB484R-FB485R



FB484R

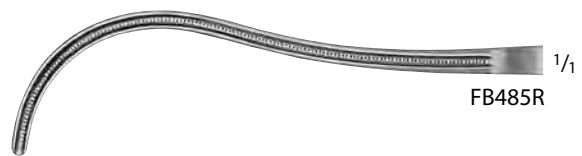

FB485R



FB498R



FB499R

HENLY Atraumatic Clamp

Catalog Number	Jaw Length (mm)	Length (in.)
FB617R	75	7 7/8



FB617R

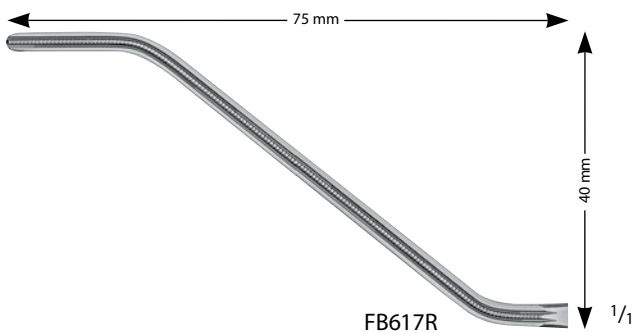

FB617R

DEBAKEY-RUMEL Atraumatic Forceps

Catalog Number	Jaw	Jaw Length (mm)	Length (in.)
FB486R	SIGHT-CVD	81	9 3/4
FB487R	CVD	81	9 5/8

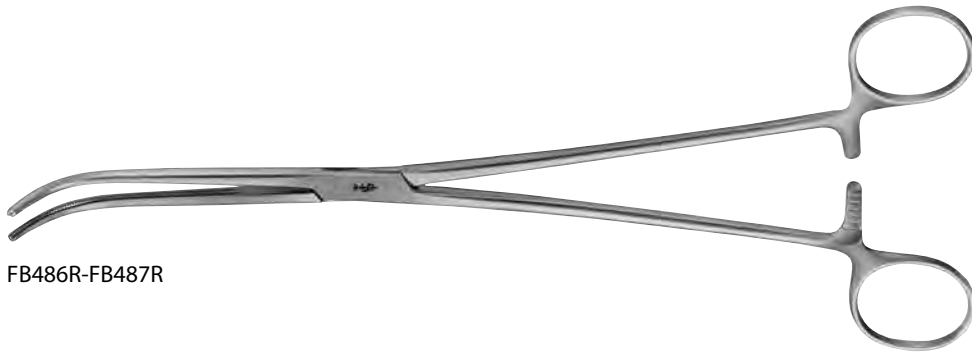

FB486R-FB487R



FB486R



FB487R

LEES Atraumatic Bronchus Clamp

Catalog Number	Jaw Angle	Jaw Length (mm)	Length (in.)
FB573R	90°	42	8 3/4



FB573R

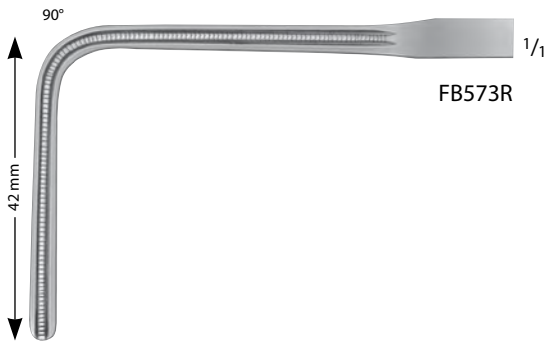

LEES Atraumatic Bronchus Clamp

Catalog Number	Jaw Angle	Jaw Length (mm)	Shaft	Length (in.)
FB574R	ANG	40	CVD	9 5/8



FB574R

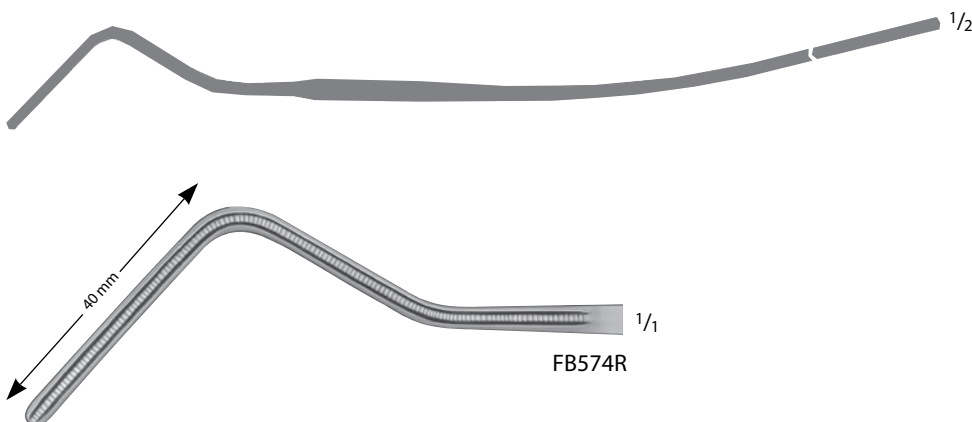

DEBAKEY Atraumatic Multi-Purpose
 Clamp

Catalog Number	Jaw Angle	Jaw Length (mm)	Length (in.)
FB510R	60°	40	9 1/2
FB511R	60°	55	8 3/4
FB512R	60°	65	11
FB513R	60°	100	12



FB510R-FB513R

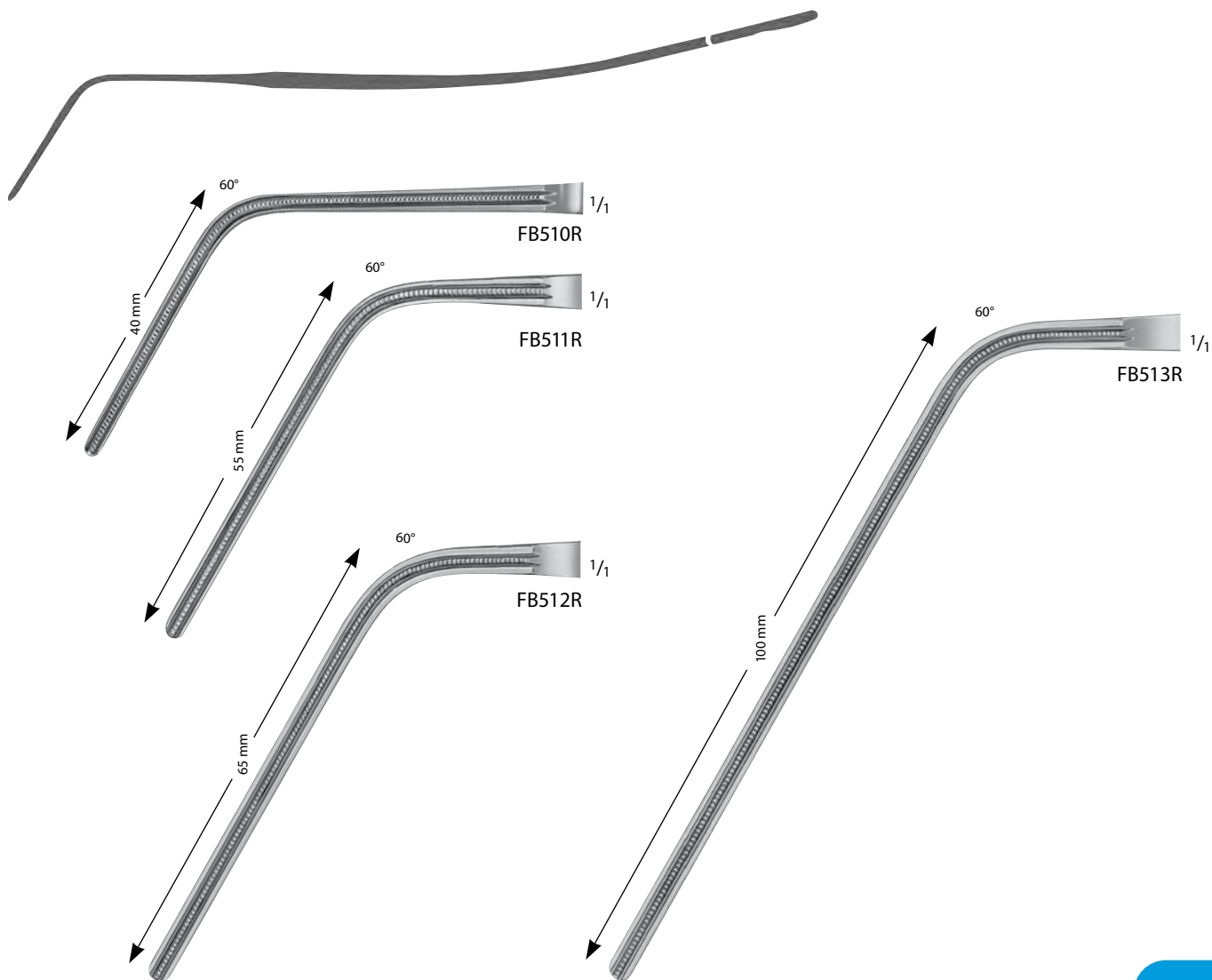

Let Us know if you could not find what you are looking for

DEBAKEY Atraumatic Multi-Purpose
 Clamp

Catalog Number	Jaw Angle	Jaw Length (mm)	Length (in.)
FB515R	90°	45	8 7/8
FB516R	90°	55	8 1/4
FB517R	90°	72	10
FB518R	90°	108	10 3/4



FB515R-FB518R

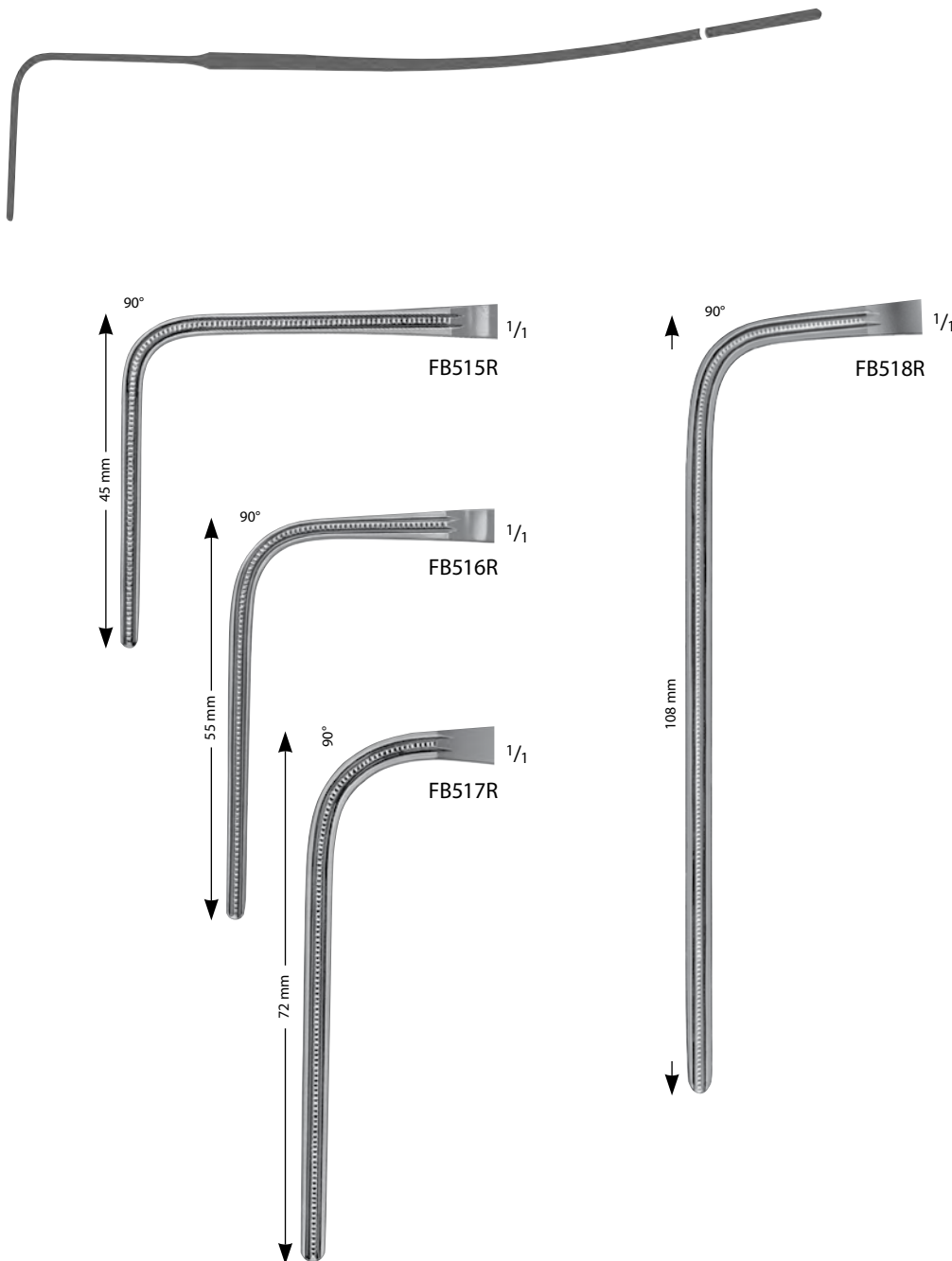

Let Us know if you could not find what you are looking for



FB618R-FB619R

LEMOLE-STRONG Atraumatic Clamp,
 Angled Shaft

Catalog Number	Jaw Size (mm)	Length (in.)
FB618R	40 x 15	7 7/8
FB619R	45 x 20	7 7/8

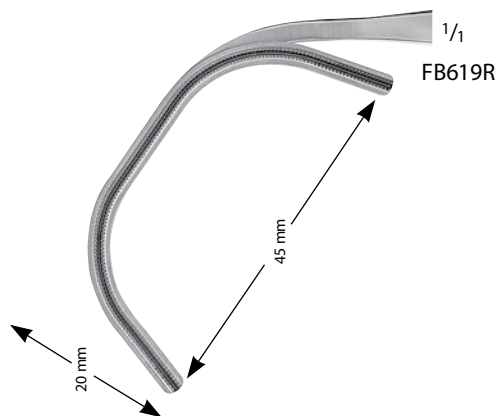
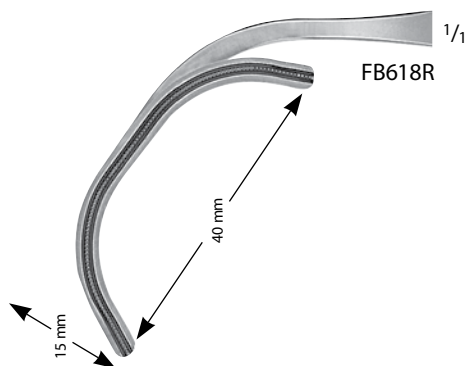

STRONG Aorta Clamp, Straight Shaft

Catalog Number	Jaw	Length (in.)
MG074R	CVD	7 7/8

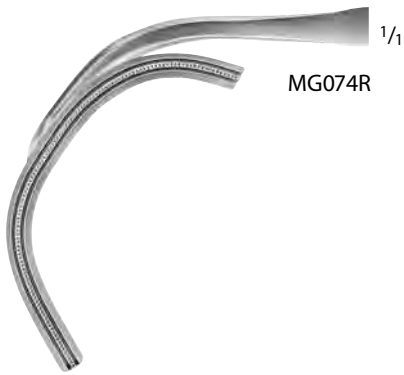
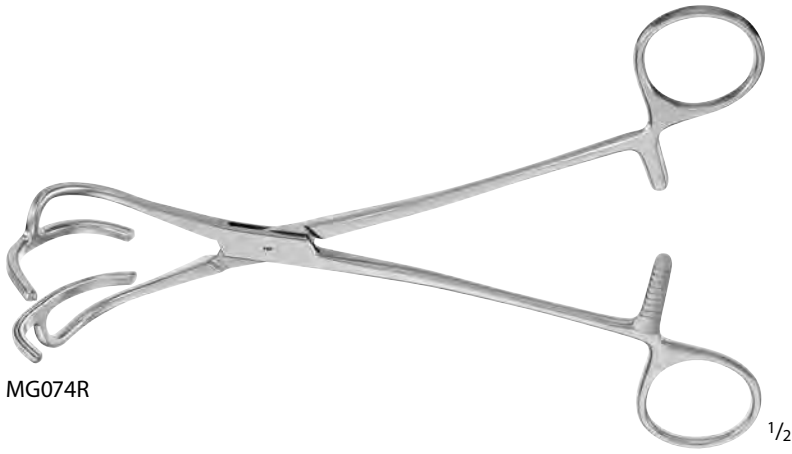

WYLIE Hypogastric Clamp

Catalog Number	Jaw	Jaw Length (mm)	Shaft	Length (in.)
MB241	CVD	70	ANG	8 1/2
MB240	CVD	75	ANG	9 3/4



MB240-MB241

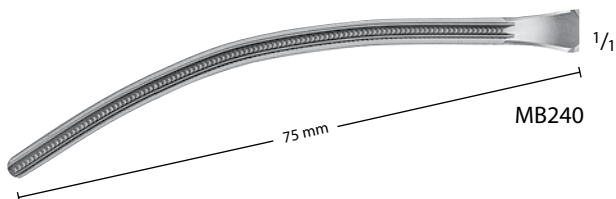
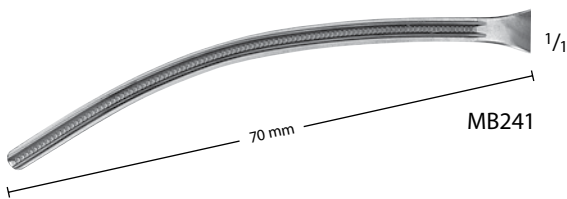

WYLIE Atraumatic Clamp

Catalog Number	Jaw	Length (in.)
FB669R	HEAVY-CVD	8 3/4
FB670R	CVD-BACK	9



FB669R-FB670R

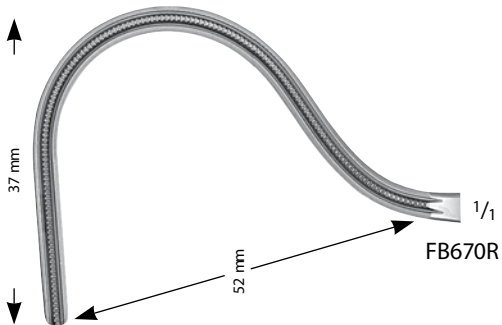
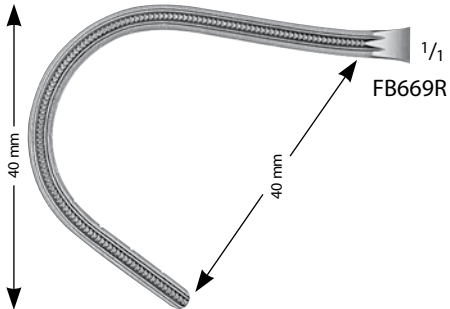

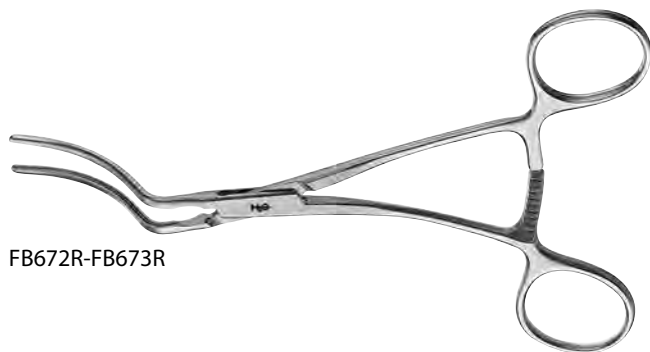

FB672R-FB673R

WYLIE Atraumatic Clamp

Catalog Number	Jaw	Length (in.)
FB672R	CVD-UP	6 1/4
FB673R	CVD-UP	7

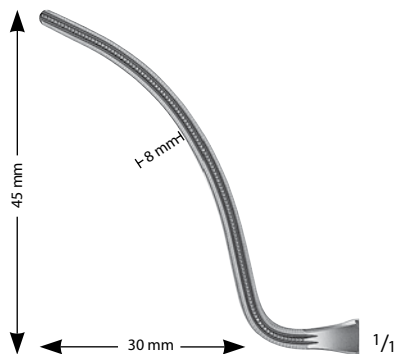

FB672R

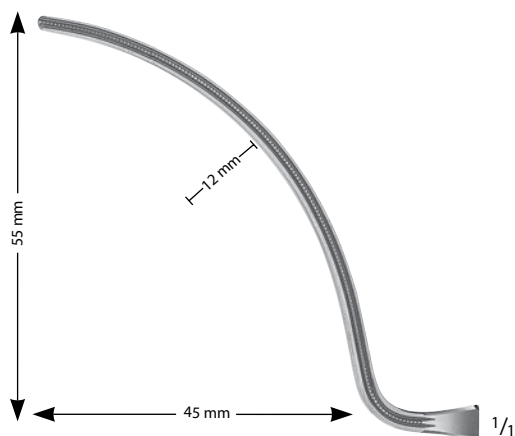

FB673R

WYLIE Atraumatic Clamp

Catalog Number	Jaw	Length (in.)
FB674R	CVD-DOWN	6
FB675R	CVD-DOWN	6 1/2

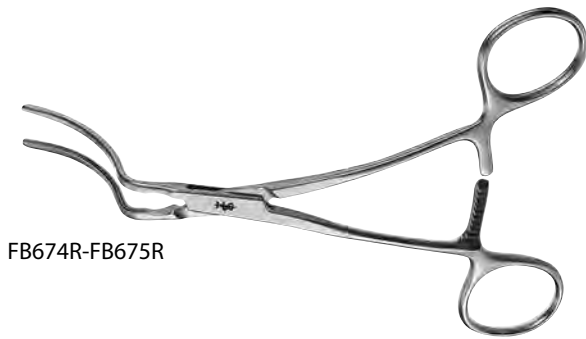

FB674R-FB675R

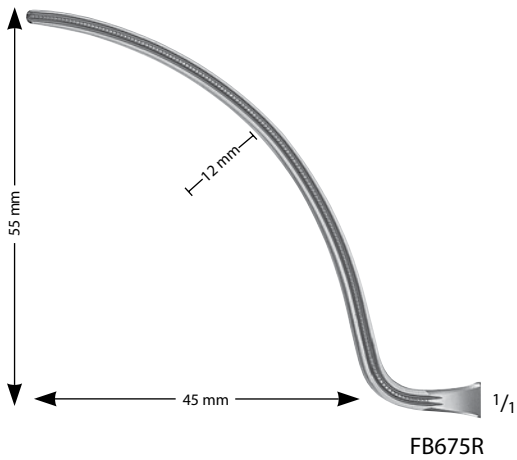
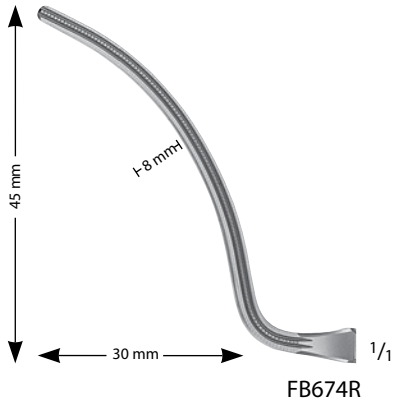

DEBAKEY Atraumatic Patent Ductus
 Clamp

Catalog Number	Jaw Length (mm)	Shaft	Length (in.)
FB450R	51	STR	8 1/4
FB451R	51	ANG	8 1/4



FB450R



FB451R

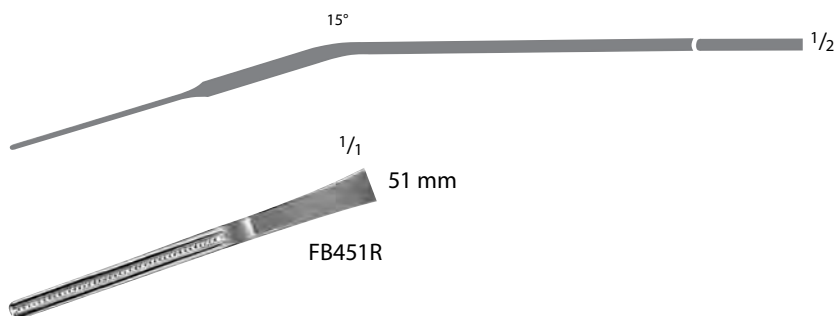



FB453R-FB457R

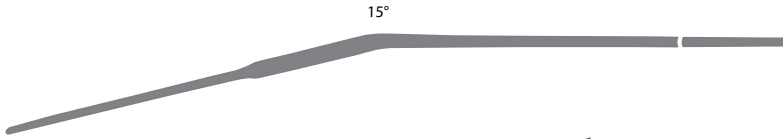

15°



FB453R



FB553R



FB455R

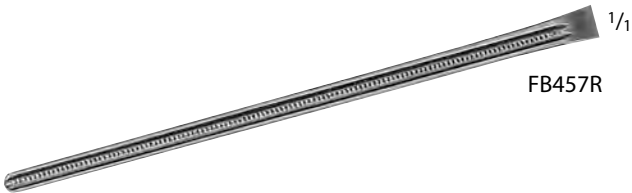

FB457R

DEBAKEY Atraumatic Coarctation
 Clamp

Catalog Number	Jaw Length (mm)	Shaft	Length (in.)
FB453R	41	ANG	7 7/8
FB553R	50	ANG	6 1/2
FB455R	65	ANG	8 7/8
FB457R	80	ANG	9 1/2



FB452R-FB552R

DEBAKEY Atraumatic Coarctation
 Clamp

Catalog Number	Jaw	Jaw Length (mm)	Length (in.)
FB452R	STR	41	8
FB552R	STR	50	6 3/4
FB454R	STR	65	8 7/8
FB456R	STR	80	9 1/2



1/1

FB452R



1/1

FB552R



1/1

FB454R



1/1

FB456R



MG423R

1/2

NOON AV Fistula Clamp

Catalog Number	Jaw Angle	Length (in.)
MG423R	50°	4 3/4



1/1

MG423R



FB458R-FB550R

GLOVER Atraumatic Clamp

Catalog Number	Jaw	Jaw Length (mm)	Length (in.)
FB458R	CVD	65	8 1/2
FB460R	SPOON SHAPED	60	8 3/4
FB550R	SPOON SHAPED	70	9 5/8
FB459R	CVD	86	9 5/8
FB461R	FULL-CVD	47	7 3/4
FB462R	FULL-CVD	63	8 1/4

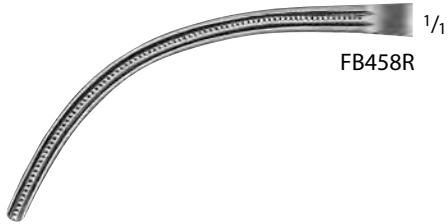

FB458R

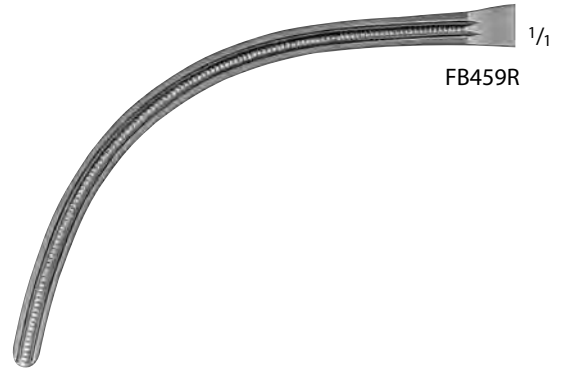

FB459R



FB460R

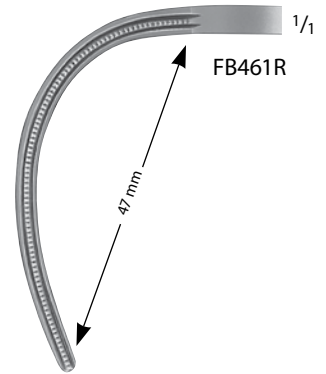

FB461R



FB550R

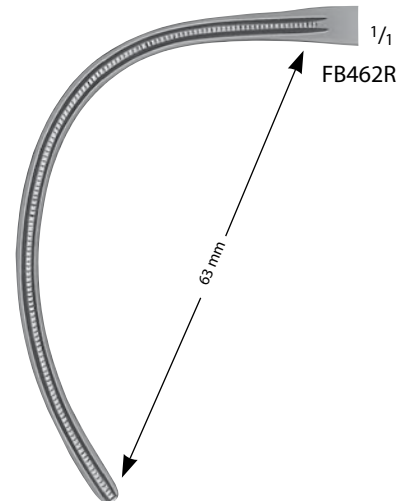

FB462R

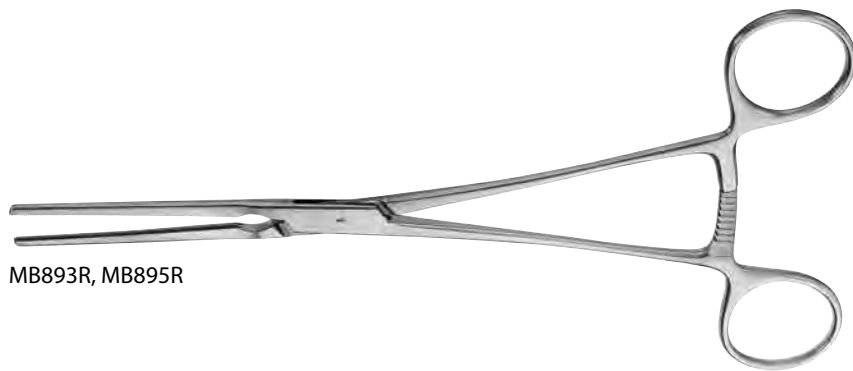

MB893R, MB895R

GLOVER Coarctation Clamp

Catalog Number	Jaw	Jaw Length (mm)	Length (in.)
MB893R	STR	60	9
MB895R	STR	70	10 1/4
MB894R	ANG	60	8 3/4
MB896R	ANG	70	10



MB893R



MB895R



MB894R, MB896R



MB894R



MB896R

GREGORY Atraumata Profunda Clamp

Catalog Number	Jaw	Jaw Length (mm)	Length (in.)
MG014R	X-SMALL	29	5
MB750R	SMALL	57	5 3/4
MB751R	MEDIUM	62	7
MB752R	LARGE	75	

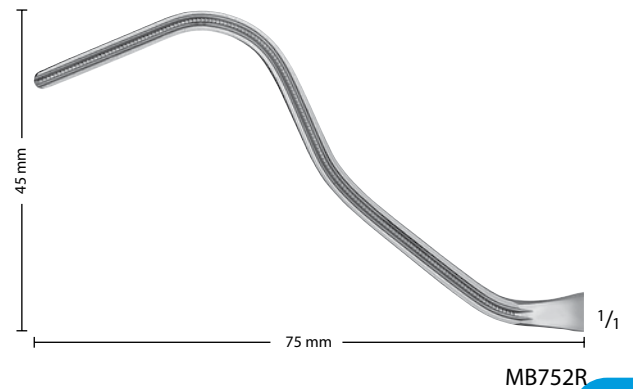
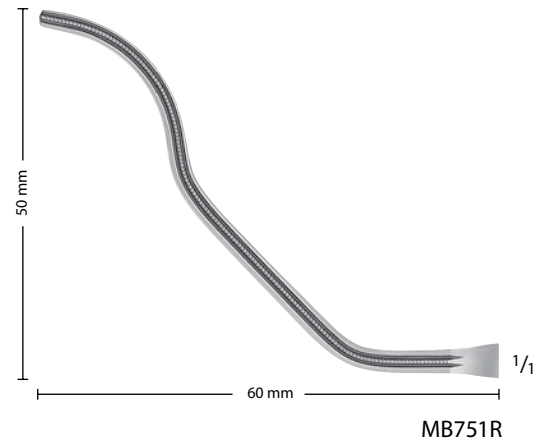
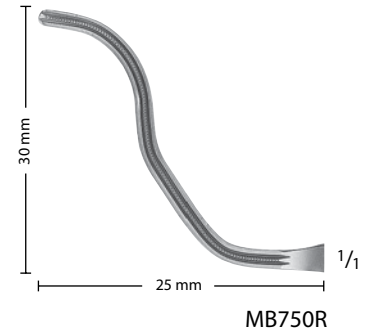
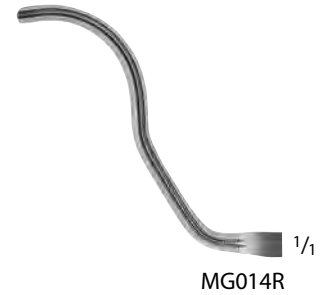
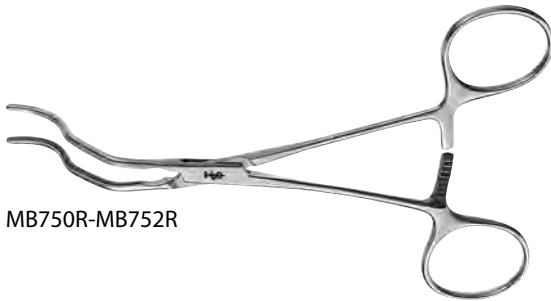
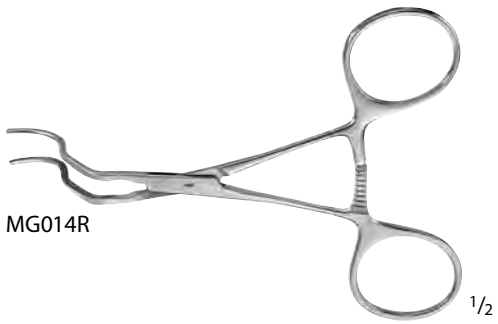

Let Us know if you could not find what you are looking for

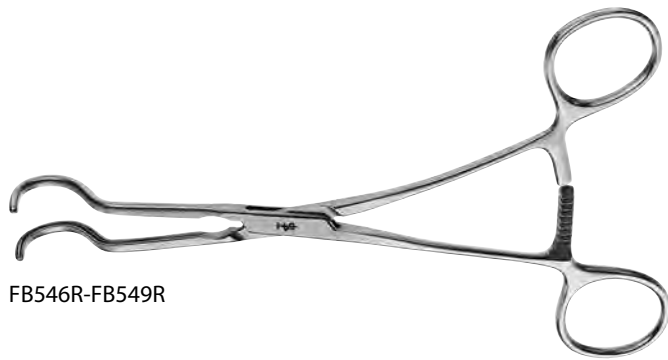

FB546R-FB549R

DALE Femoral Popliteal Clamp

Catalog Number	Jaw	Length (in.)
FB546R	SMALL	6 7/8
FB547R	MEDIUM	7
FB548R	LARGE	7
FB549R	-	7

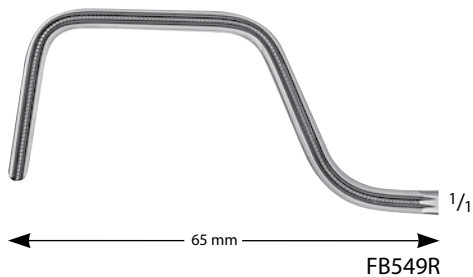
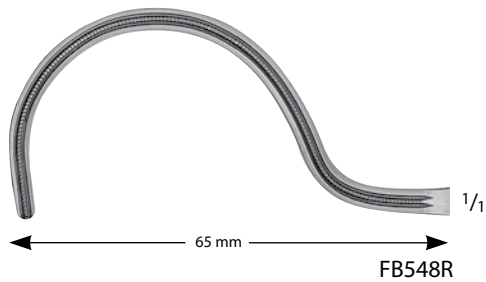
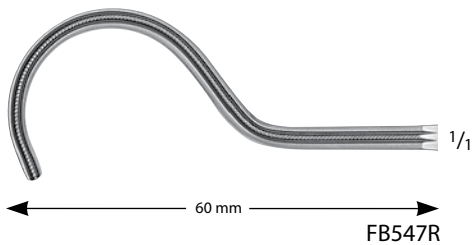
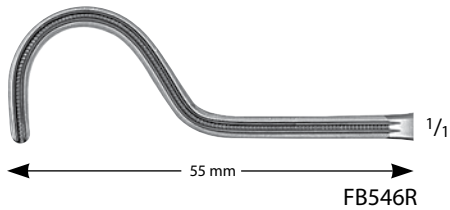

SELMAN Vessel Forceps

Catalog Number	Jaw	Jaw Length (mm)	Length (in.)
MG361R	STR, COOLEY SERR	25	5 1/4
MG362R	ANG, COOLEY SERR	25	5 1/4

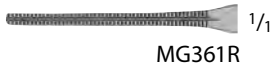

CHERRY Clamp

Catalog Number	Jaw	Teeth	Shaft	Length (in.)
MG368R	CVD	2 x 3	60° ANG	12 3/8

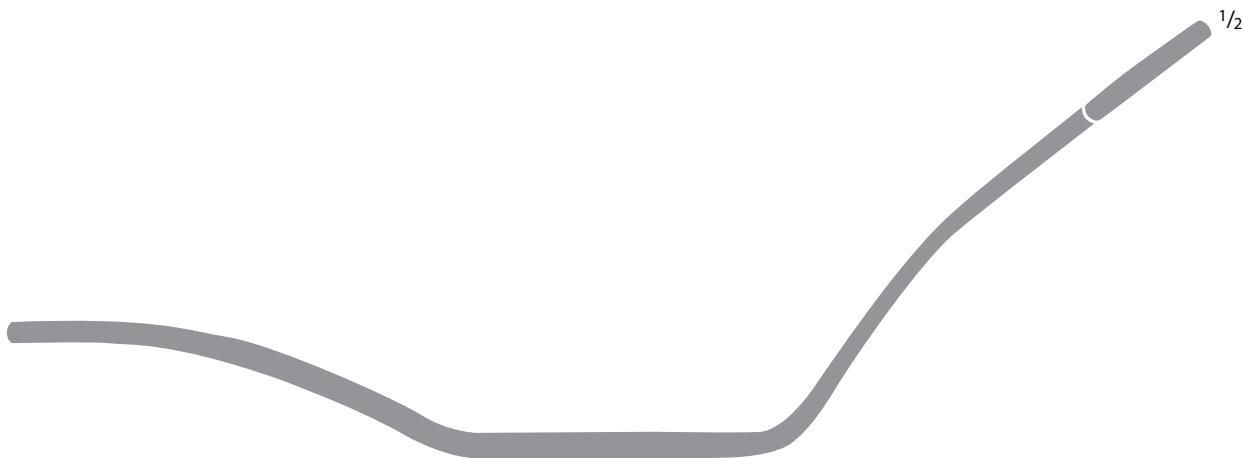



FB463R

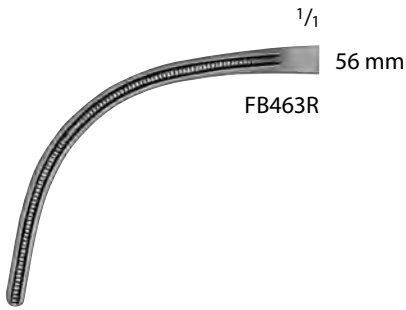

1/1

56 mm

FB463R

DEBAKEY Atraumatic Peripheral
 Clamp #1

Catalog Number	Jaw Length (mm)	Length (in.)
FB463R	56	6 1/4



FB464R

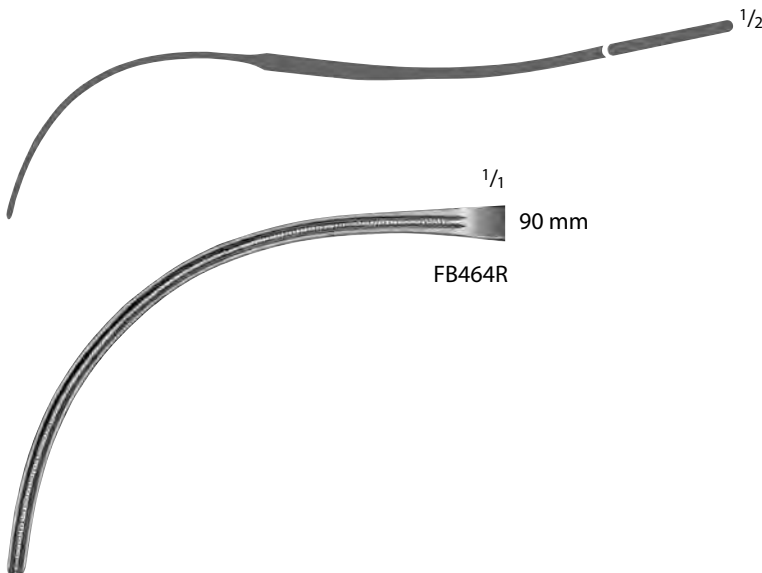

1/1

90 mm

FB464R

DEBAKEY Atraumatic Peripheral
 Clamp #2

Catalog Number	Jaw Length (mm)	Length (in.)
FB464R	90	7 1/2

DEBAKEY Atraumatic Peripheral
 Clamp #3

Catalog Number	Jaw Length (mm)	Length (in.)
FB465R	93	7 7/8



FB465R

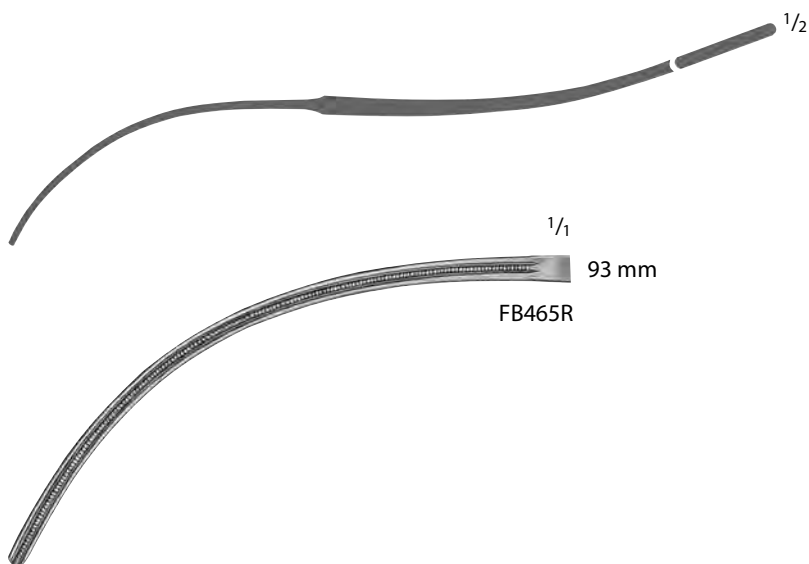

FB465R

DEBAKEY Atraumatic Peripheral
 Clamp #4

Catalog Number	Jaw Angle	Jaw Length (mm)	Length (in.)
FB466R	60°	77	7



FB466R

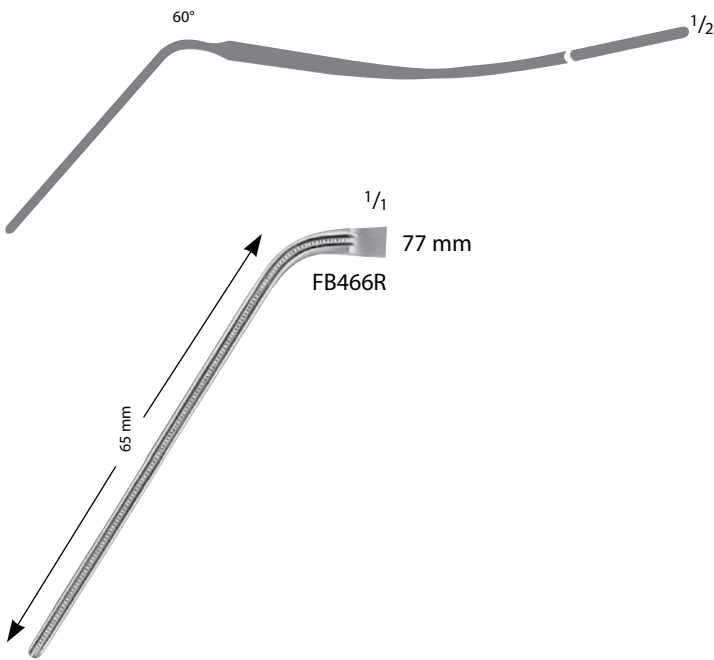

DEBAKEY Atraumatic Iliac Clamp

Catalog Number	Jaw Angle	Jaw Length (mm)	Length (in.)
FB470R	60°	65	7 7/8

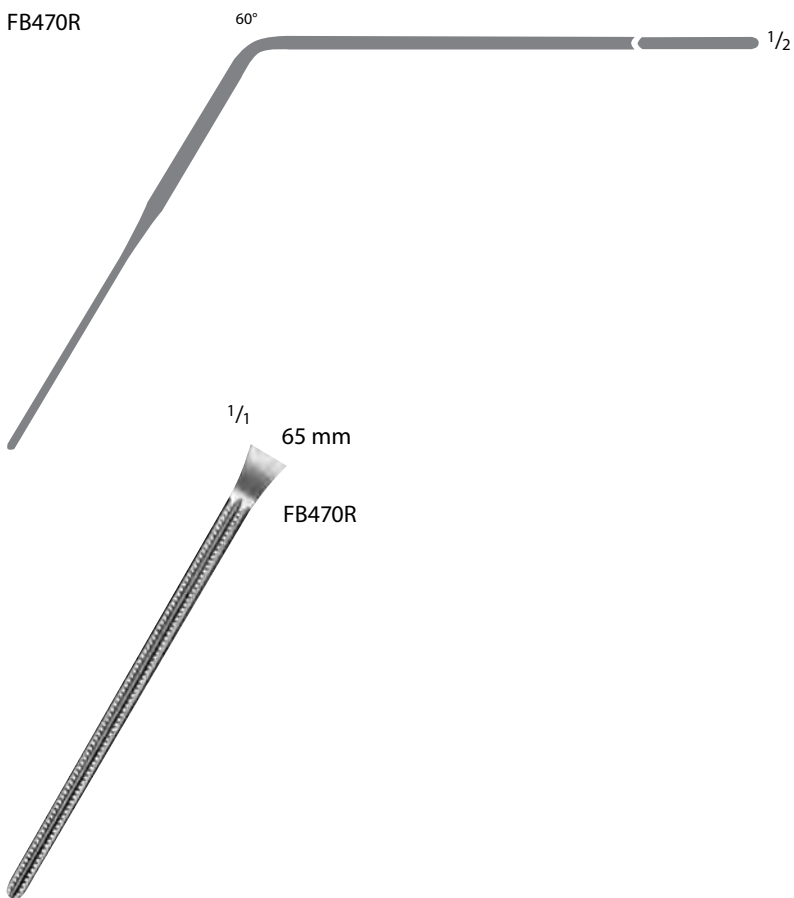

COOLEY Aortic Aneurysm Clamp

Catalog Number	Jaw	Jaw Length (mm)	Length (in.)
MG448R	CVD	75	10

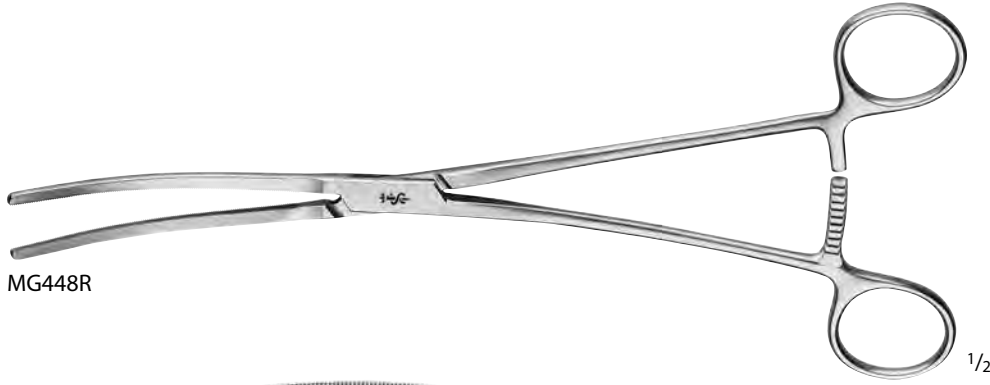

MG448R



MG448R

DEBAKEY Atraumatic Aortic Aneurysm
 Clamp, Light Curved

Catalog Number	Jaw	Jaw Length (mm)	Length (in.)
FB471R	2 x 3 SERR	95	9 3/4
FB472R	2 x 3 SERR	110	11 3/4
FB473R	2 x 3 SERR	130	12 3/8
FB480R	2 x 3 SERR	140	12 3/4

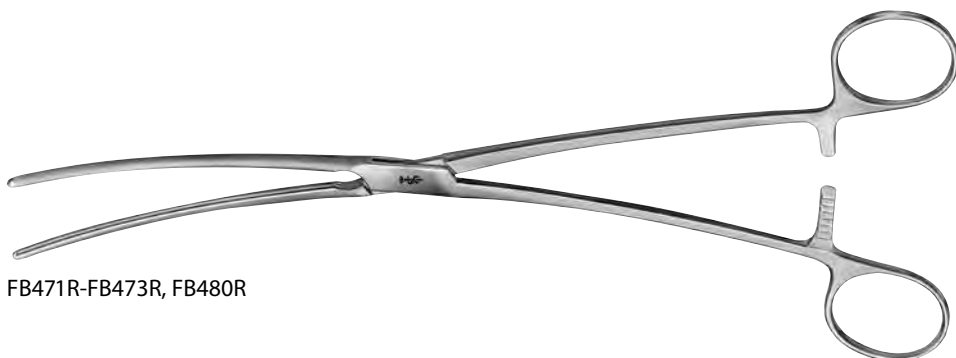

FB471R-FB473R, FB480R



FB471R



FB472R



FB473R



FB480R

DEBAKEY Atraumatic Aortic Aneurysm
 Clamp

Catalog Number	Jaw	Jaw Length (mm)	Length (in.)
FB478R	SLIGHT-CVD	70	10
FB477R	CVD	75	10 1/2
FB476R	HEAVY-CVD	85	11



FB476R-FB478R

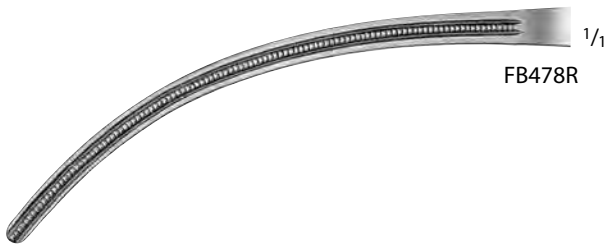

FB478R

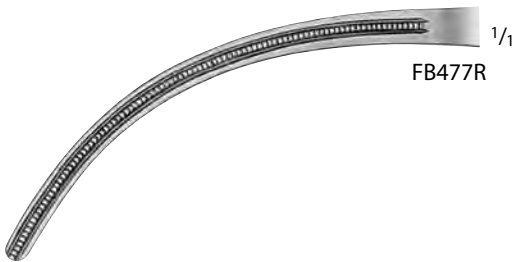

FB477R

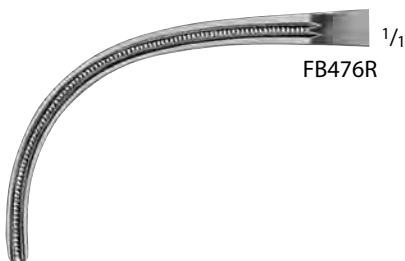

FB476R

DEBAKEY Atraumatic Aortic Aneurysm
 Clamp, S-Curved

Catalog Number	Jaw Length (mm)	Length (in.)
FB475R	115	11 3/4



FB475R

1/2



1/2



FB475R

1/1

DEBAKEY-SEMB Atraumatic Aortic
 Aneurysm Clamp, Curved

Catalog Number	Jaw Length (mm)	Length (in.)
FB482R	100	10 1/2



FB482R

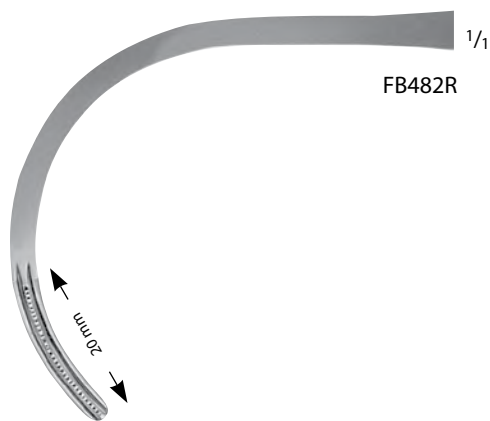

FB482R

DEBAKEY Atraumatic Aortic Aneurysm
 Clamp, Full Curved

Catalog Number	Jaw Length (mm)	Length (in.)
FB481R	111	10 5/8



FB481R

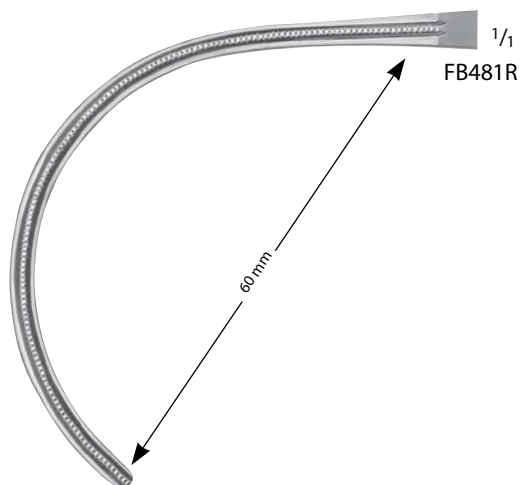
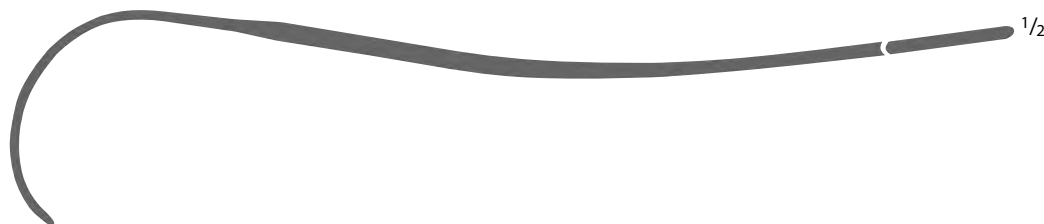

WEBER Atraumatic Aortic Clamp, Left

Catalog Number	Jaw Length (mm)	Length (in.)
FB488R	113	10 1/4

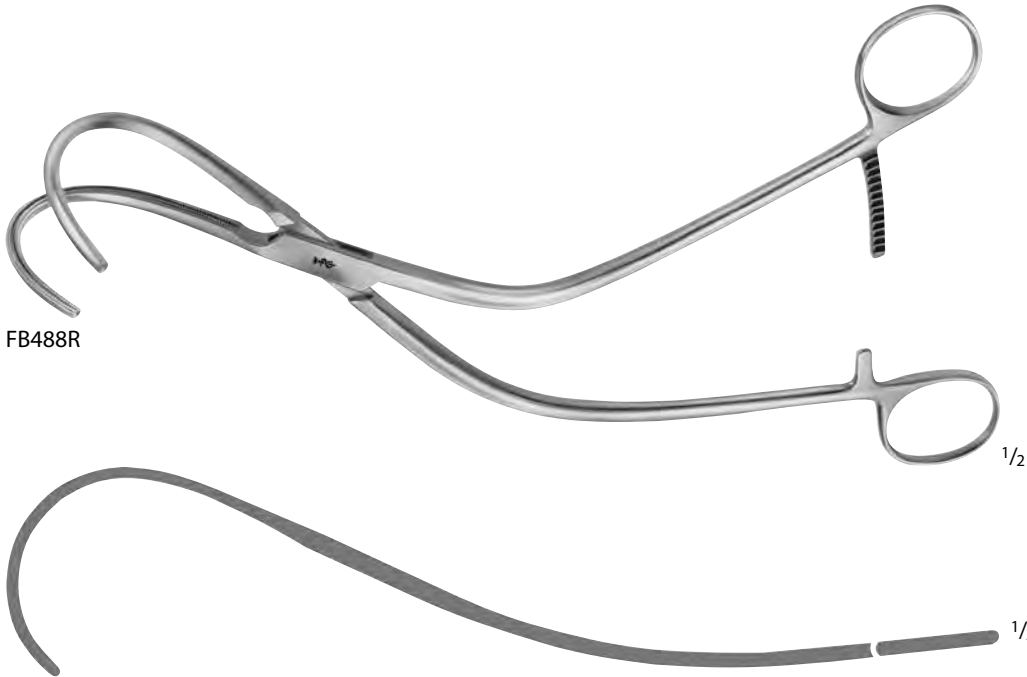

FB488R

1/2

1/2

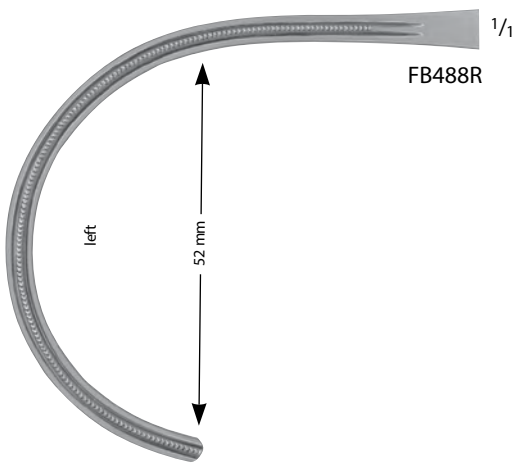

FB488R

left

52 mm

1/1

WEBER Atraumatic Aortic Clamp, Right

Catalog Number	Jaw Length (mm)	Length (in.)
FB489R	113	10 1/4

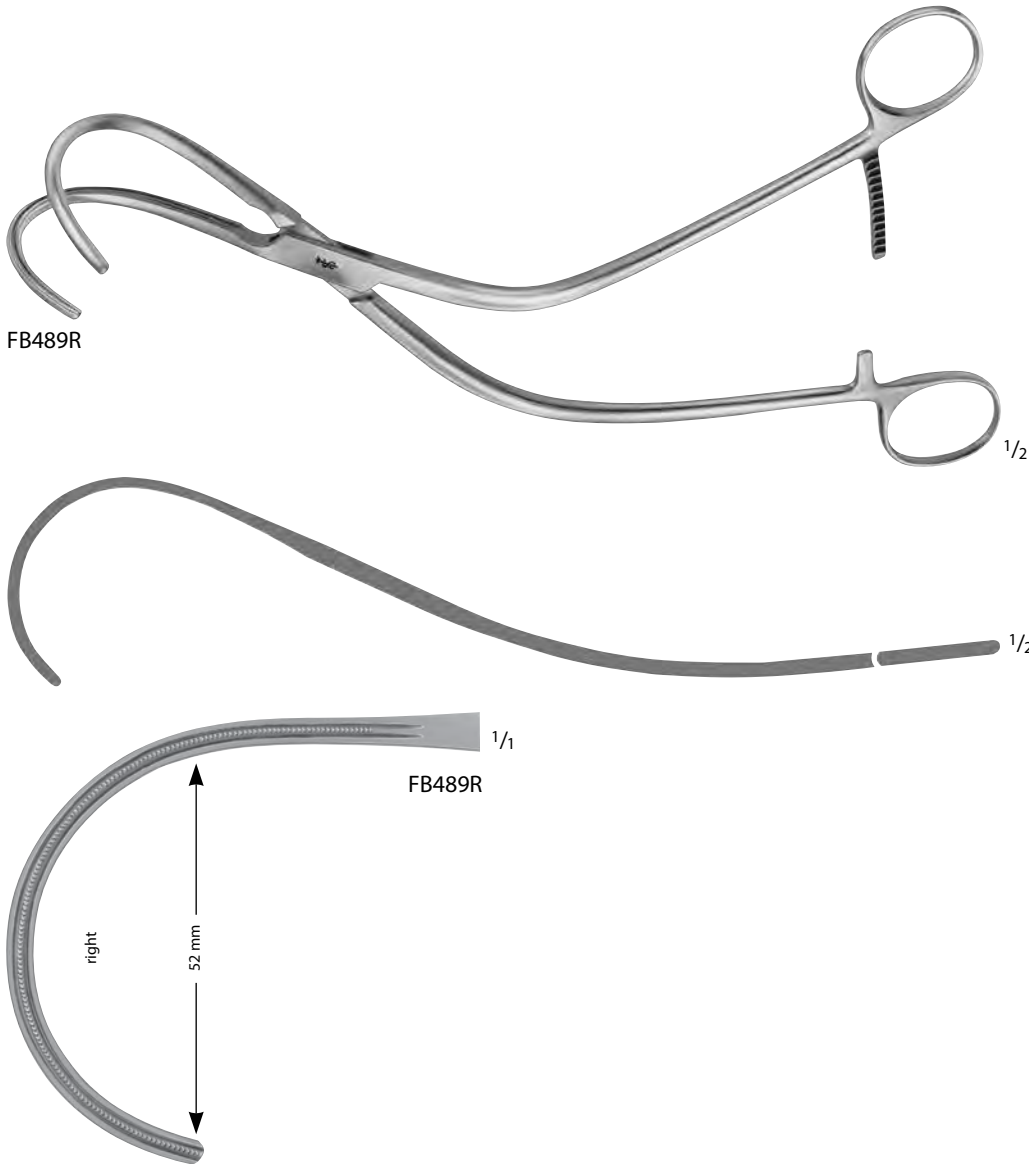

LAMBERT-KAY Atraumatic Aortic
 Clamp

Catalog Number	Weight	Jaw Length (mm)	Length (in.)
FB490R	LIGHT	93	8 1/2
FB492R	HEAVY	100	8 1/4



FB490R-FB492R

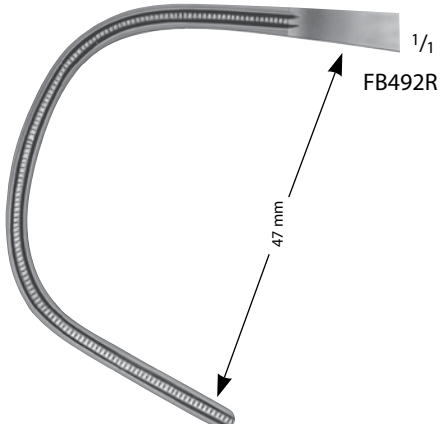
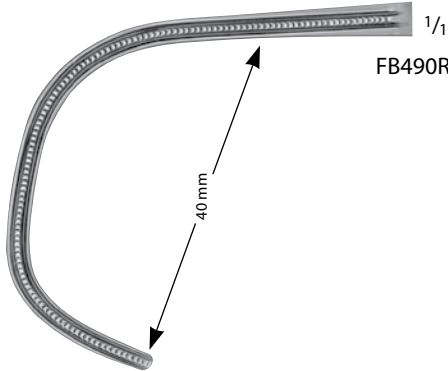

Let Us know if you could not find what you are looking for

DEBAKEY-LAMBERT Atraumatic Aortic
 Clamp

Catalog Number	Jaw Angle	Jaw Length (mm)	Length (in.)
FB491R	MULTI	40	10



FB491R

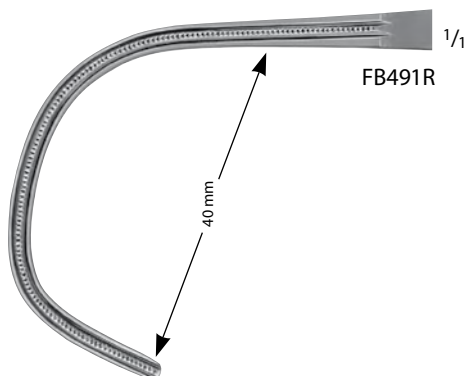
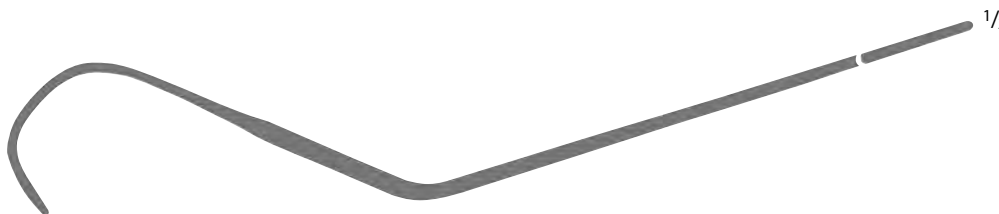

MORRIS Atraumatic Aortic Cross Clamp

Catalog Number	Jaw Angle	Jaw Length (mm)	Length (in.)
FB493R	70°	67	6 7/8

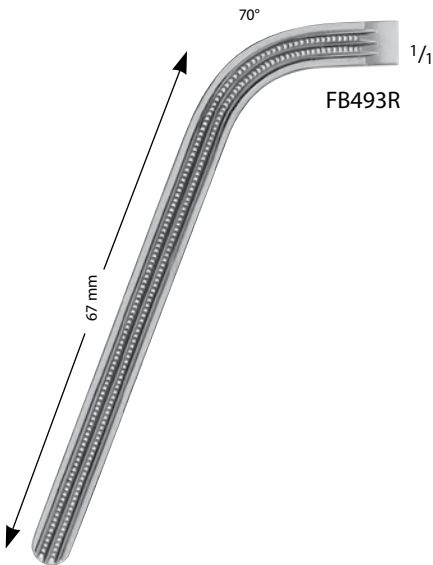

DEBAKEY-MORRIS Atraumatic
 Cross-Clamp

Catalog Number	Jaw Angle	Jaw Length (mm)	Length (in.)
FB494R	70°	70	9 1/2

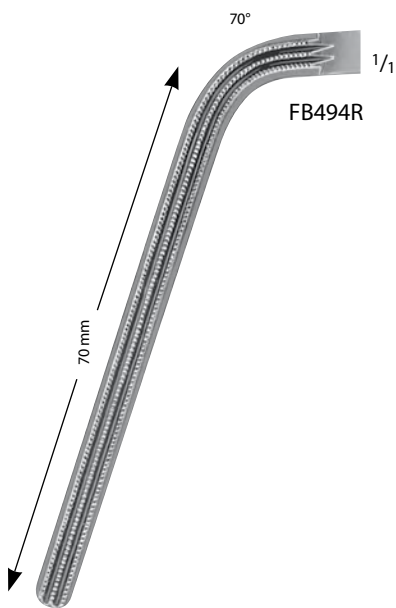
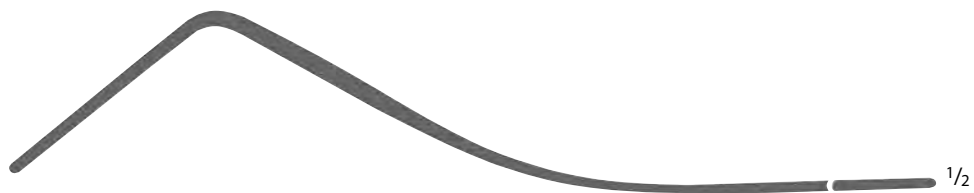
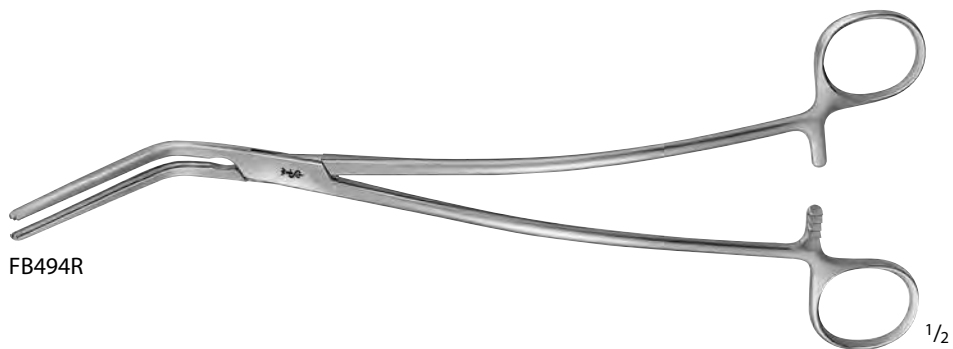

OCHSNER Atraumatic Aortic Clamp

Catalog Number	Jaw Angle	Jaw Length (mm)	Length (in.)
FB495R	70°	50	10 1/4

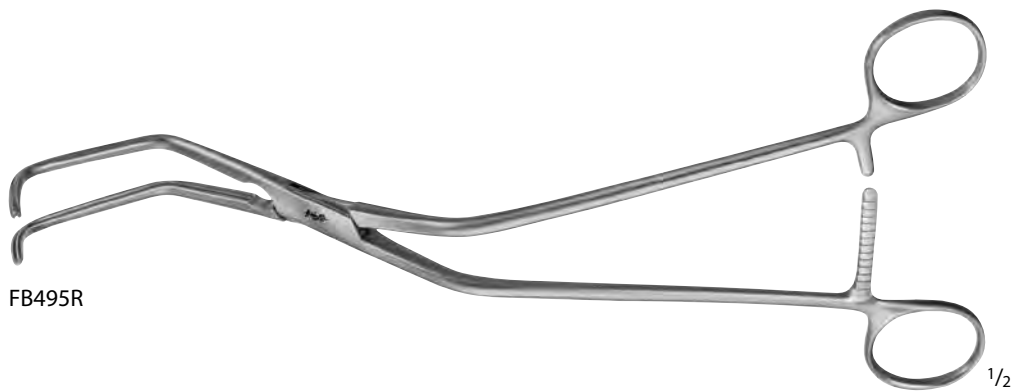

FB495R

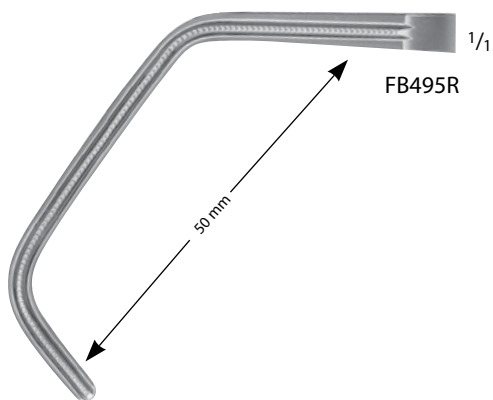
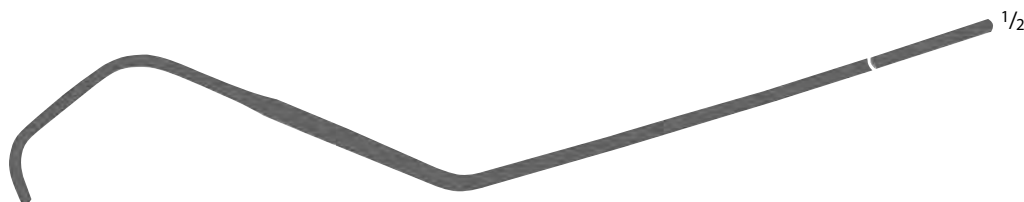

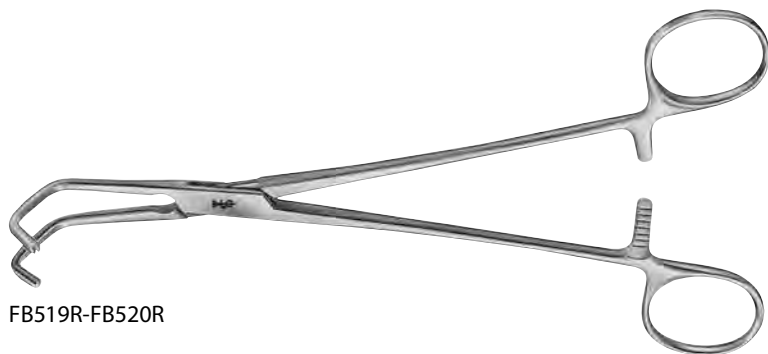

FB519R-FB520R

DEBAKEY-BECK Atraumatic Vena Cava
 Clamp

Catalog Number	Jaw Length (mm)	Length (in.)
FB519R	30	8
FB520R	45	8 1/4

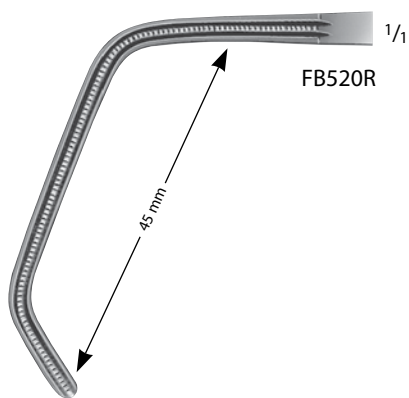
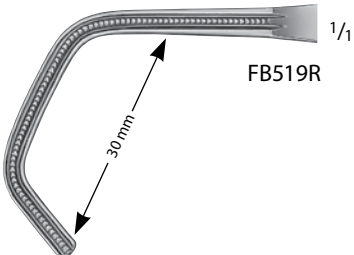



FB500R-FB504R



DEBAKEY Atraumatic Tangential Clamp

Catalog Number	Jaw Size (#)	Jaw Length (mm)	Length (in.)
FB500R	1	38	8 3/4
FB501R	2	48	10 1/2
FB502R	3	54	10 5/8
FB503R	4	58	10 5/8
FB504R	5	75	11

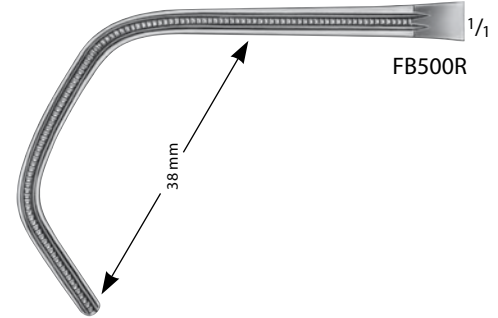

FB500R

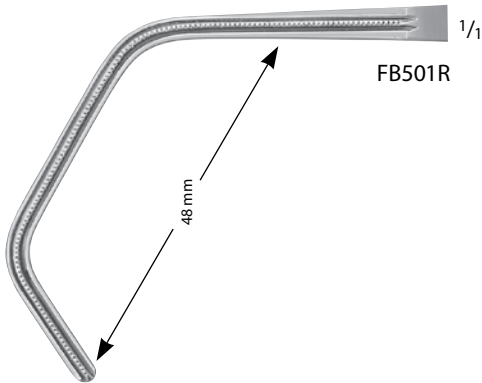

FB501R

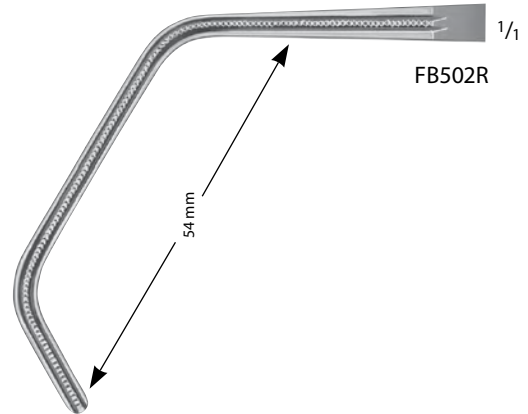

FB502R

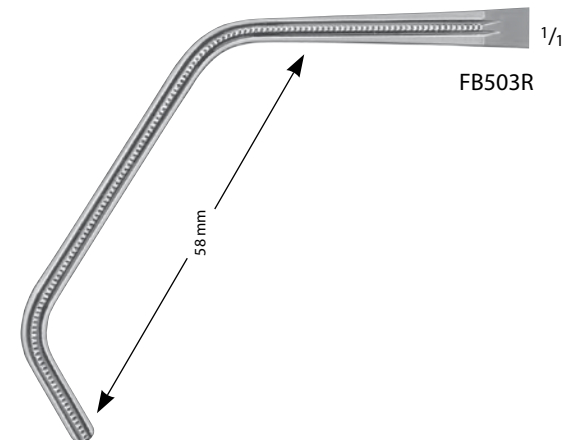

FB503R

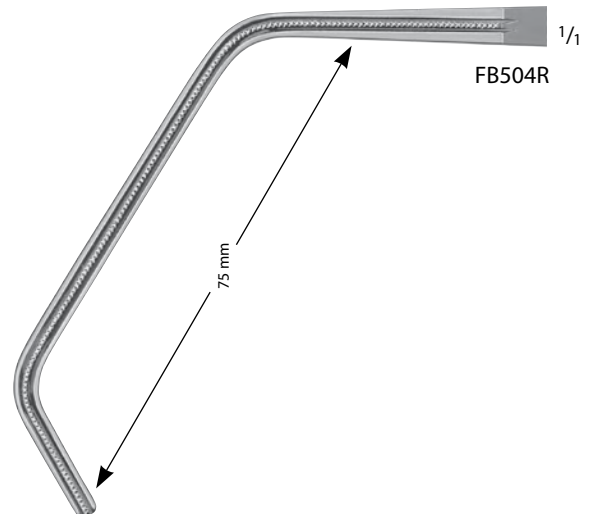

FB504R

Let Us know if you could not find what you are looking for

DEBAKEY-SATINSKY Atraumatic
 Tangential Clamp

Catalog Number	Jaw Length (mm)	Length (in.)
FB506R	32	9 1/4
FB507R	40	9 1/2
FB508R	47	9 5/8



FB506R-FB508R

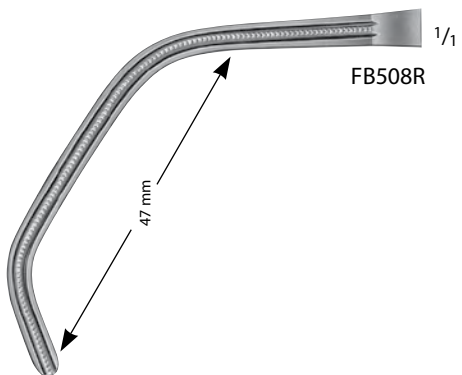
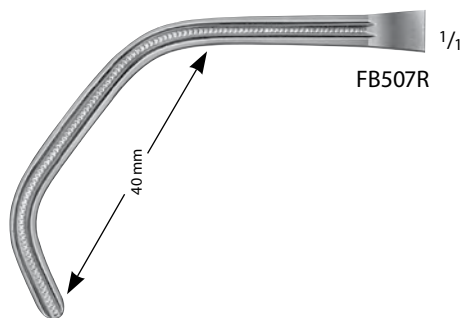
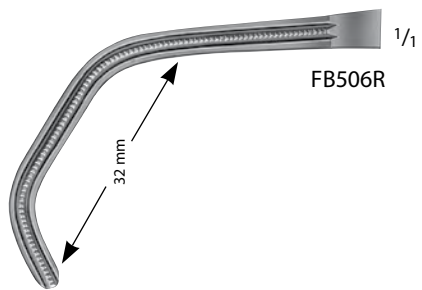
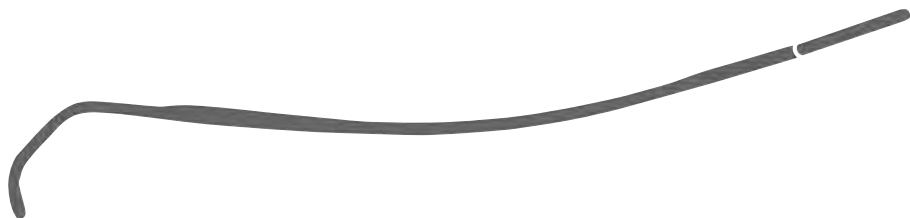

DEBAKEY Atraumatic Sidewinder
 Aortic Clamp

Catalog Number	Jaw Angle	Jaw Length (mm)	Length (in.)
FB576R	70°	60	10 1/2



FB576R

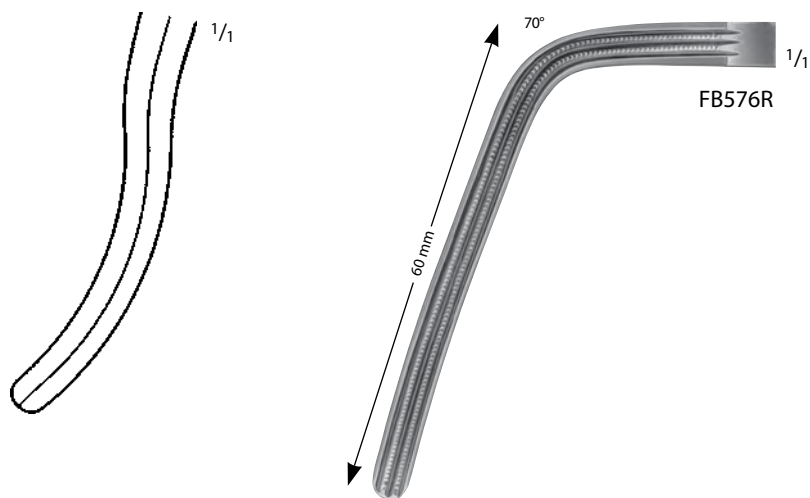

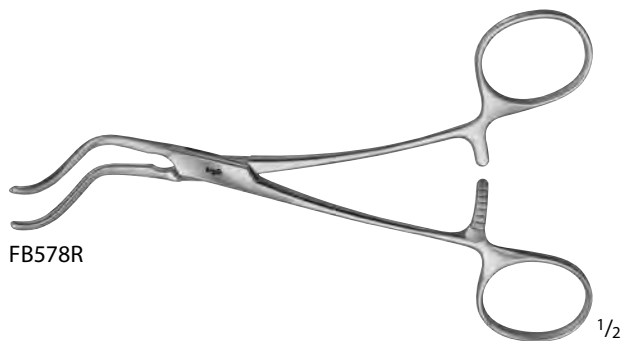

DEBAKEY-SUBRAMANIAN Atraumatic Aortic Clamp

Catalog Number	Jaw Angle	Jaw Length (mm)	Length (in.)
FB578R	70°	30	6 1/8

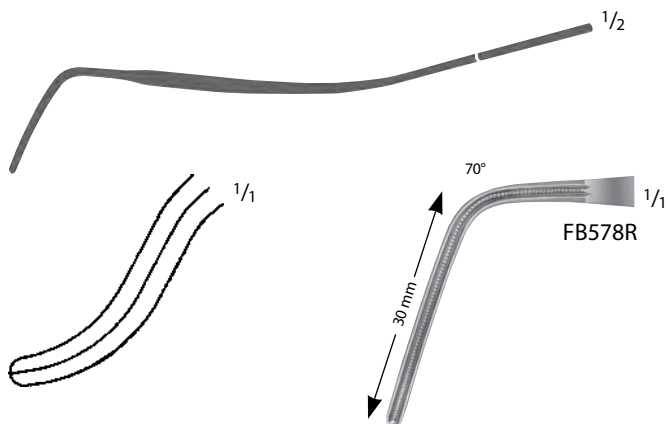

DEBAKEY Vascular Clamp

Catalog Number	Jaw Angle	Jaw Length (mm)	Length (in.)
US123	60°	40	4 1/4
US124	90°	40	3 3/4

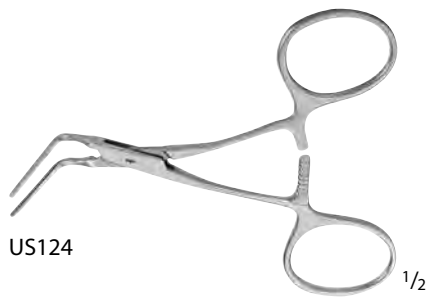
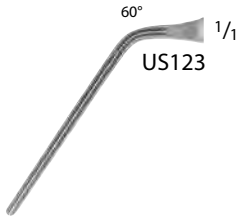

DEBAKEY Partial Occlusion Clamp

Catalog Number	Jaw Angle	Jaw Length (mm)	Length (in.)
US125	MULTI	24	4 1/2

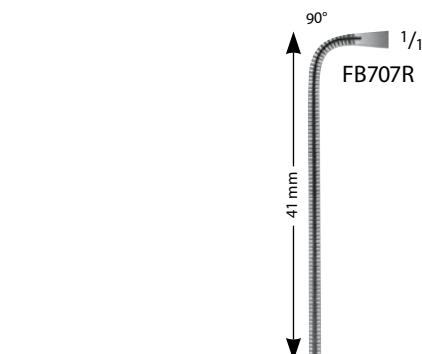
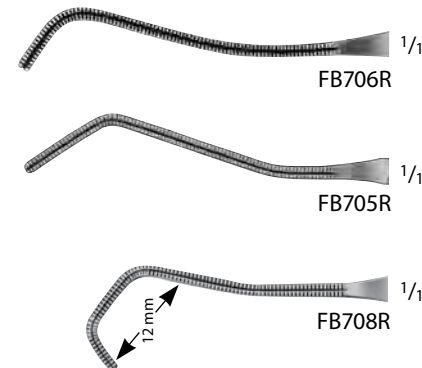
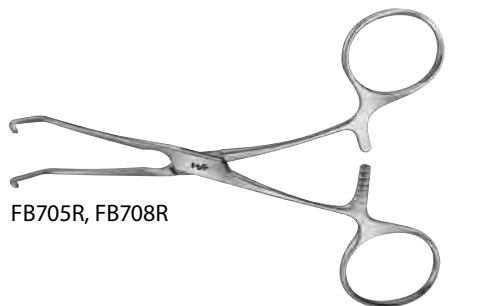
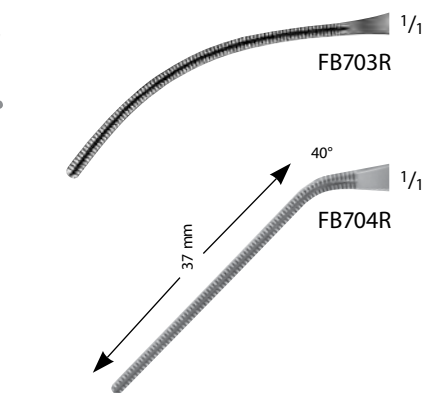
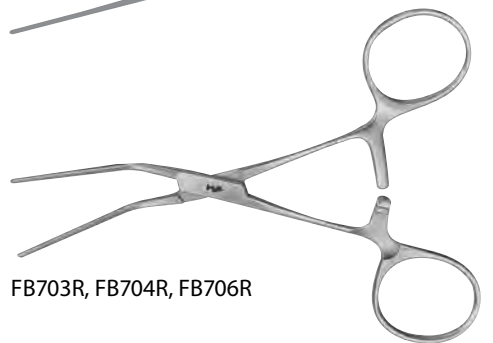
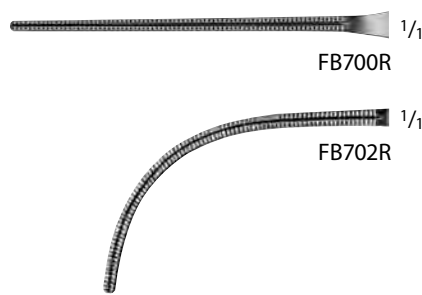
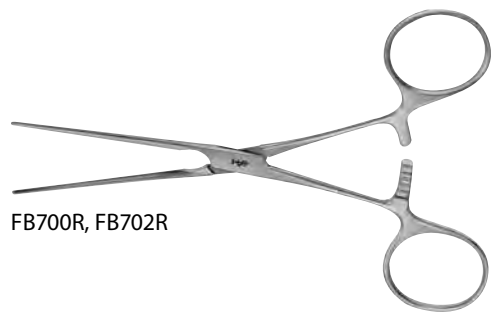

COOLEY Atraumatic Ring Handle
 Bulldog Clamp

Catalog Number	Shaft Angle	Jaw Angle	Jaw Length (mm)	Length (in.)
FB700R	STR	STR	50	5
FB702R	STR	CVD	50	4 1/2
FB701R	15° ANG	STR	50	5
FB703R	SLIGHT-CVD	CVD	50	5
FB704R	SLIGHT-CVD	40°	37	4 3/4
FB706R	SLIGHT-CVD	MULTI	52	5
FB705R	CVD	MULTI	50	4 3/4
FB708R	CVD	MULTI	12	4 1/4
FB707R	ANG	90°	41	4

Let Us know if you could not find what you are looking for

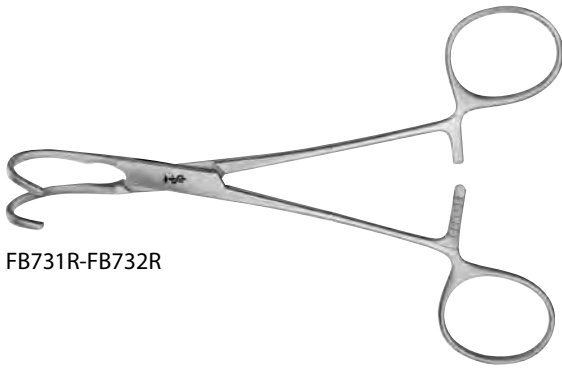

FB731R-FB732R

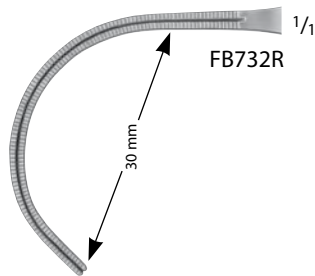
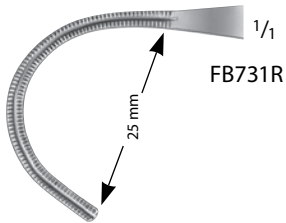

COOLEY-BECK Atraumatic Pediatric
 Clamp, Curved

Catalog Number	Jaw Length (mm)	Length (in.)
FB731R	25	6
FB732R	30	6 1/8

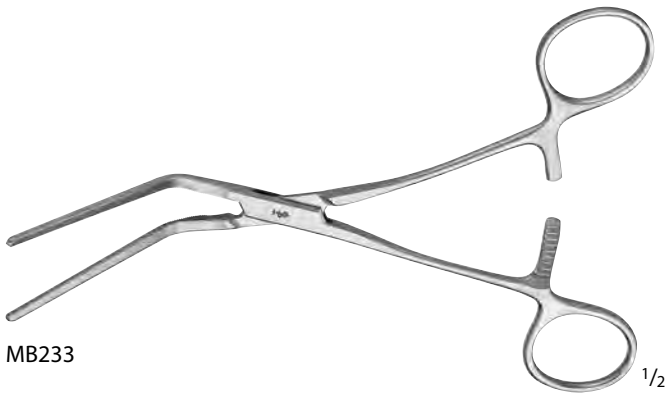

MB233

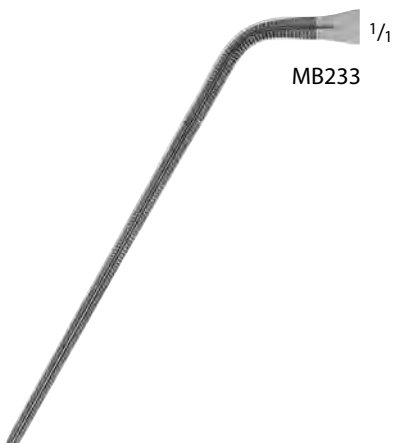

COOLEY Atraumatic Peripheral Vascular
 Clamp, Angled

Catalog Number	Jaw Length (mm)	Length (in.)
MB233	65	7

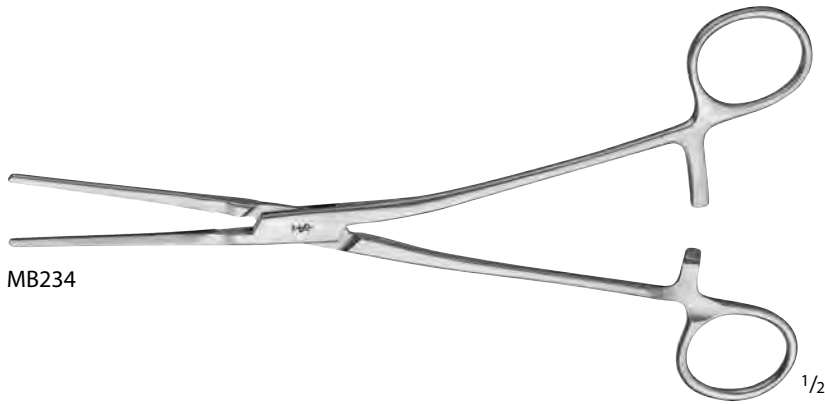

MB234



MB234

COOLEY Atraumatic Coarctation Clamp,
 Straight Jaw, Angled Shaft

Catalog Number	Jaw Length (mm)	Length (in.)
MB234	60	8 3/4



MB350R



MB350R

COOLEY Atraumatic Coarctation Clamp,
 Straight Jaw, Straight Shaft

Catalog Number	Jaw Length (mm)	Length (in.)
MB350R	50	8 3/4

DERRA-COOLEY Atraumatic Clamp

Catalog Number	Jaw Length (mm)	Length (in.)
FB725R	16	6 3/4
FB726R	21	6 7/8
FB727R	27	6 7/8

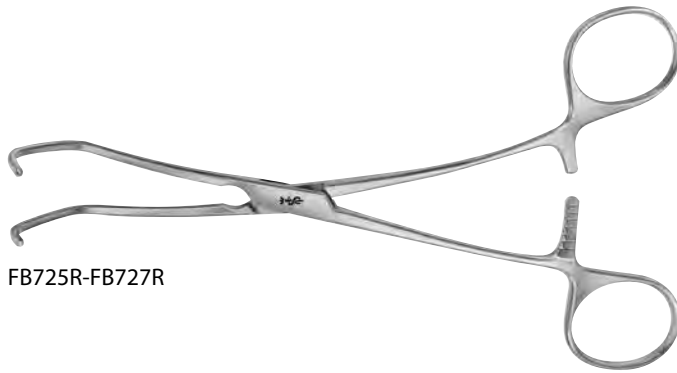

FB725R-FB727R

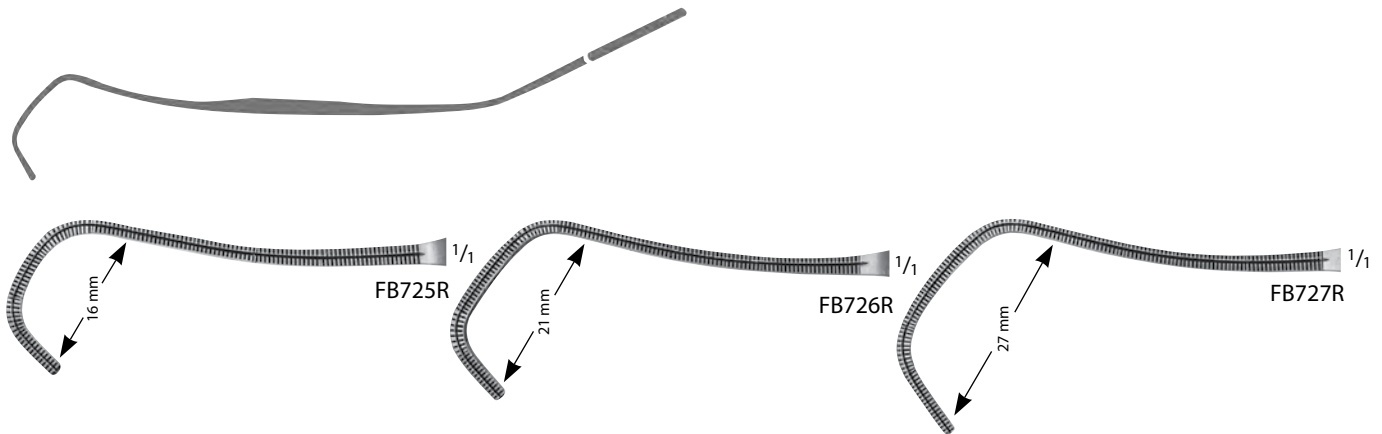

COOLEY Atraumatic Clamp, Spoon Shaped

Catalog Number	Jaw Length (mm)	Length (in.)
FB743R	42	5 3/4

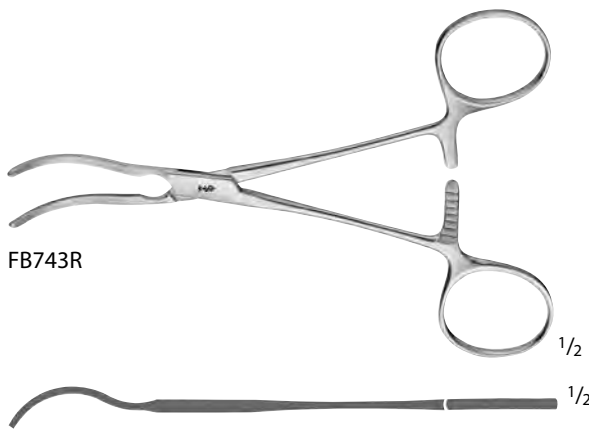

FB743R



FB743R

COOLEY-SATINSKY Atraumatic Pediatric Clamp

Catalog Number	Jaw Length (mm)	Length (in.)
MB613R	21	5 1/2

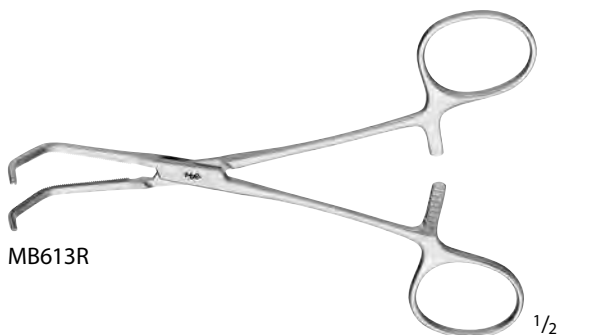

MB613R

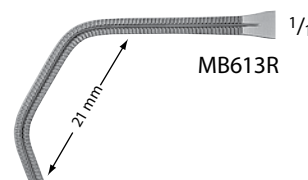

MB613R



MB348R

COOLEY Atraumatic Cardiovascular
 Clamp, Curved

Catalog Number	Jaw Length (mm)	Length (in.)
MB348R	55	8 1/4

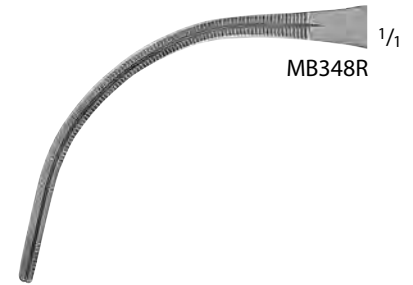

MB743R-MB747R

HENDREN Atraumatic Cardiovascular
 Clamp

Catalog Number	Jaw Length (mm)	Length (in.)
MB743R	13	8 1/4
MB744R	30	8 1/2
MB745R	35	8 1/2
MB746R	40	8 3/4
MB747R	45	8 3/4

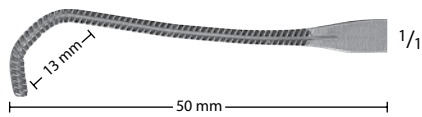

MB743R

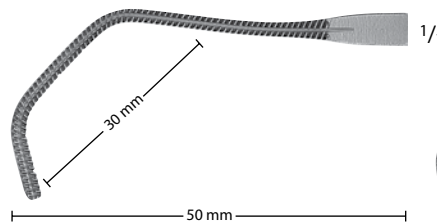

MB744R

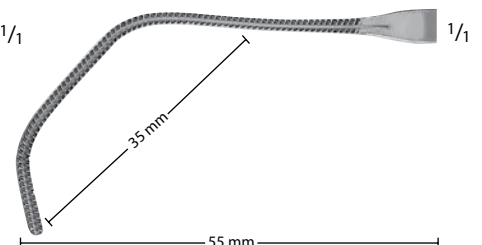

MB745R

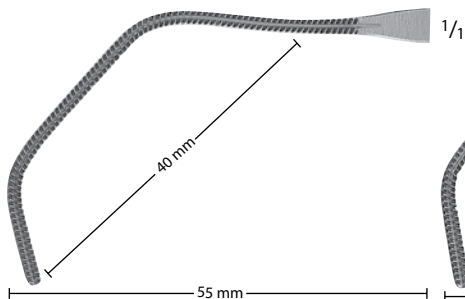

MB746R

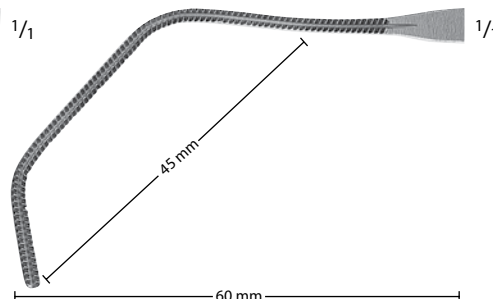

MB747R

COOLEY Atraumatic Pediatric
 Anastomosis Clamp, Curved

Catalog Number	Jaw Length (mm)	Length (in.)
FB734R	36	6 3/4
FB735R	44	6 3/4

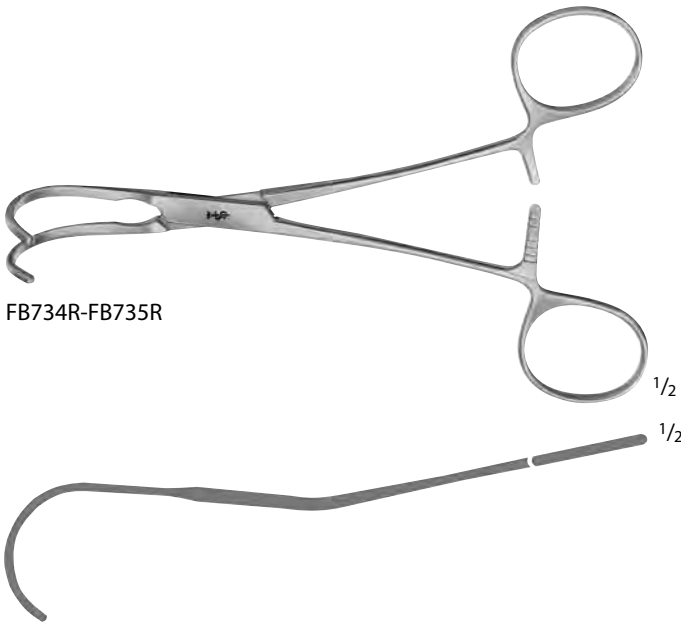

FB734R-FB735R

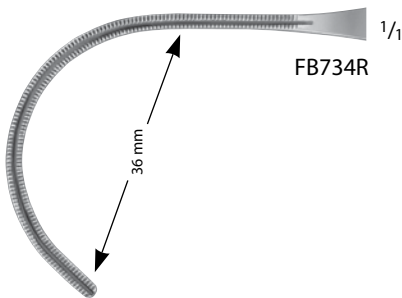

FB734R

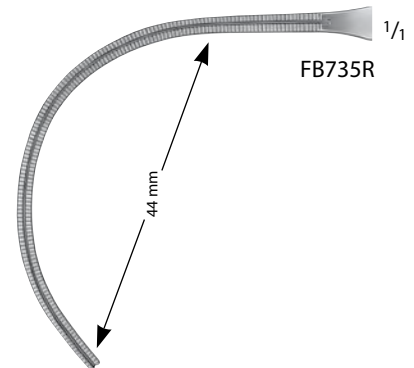

FB735R

POTTS Anastomosis Clamp

Catalog Number	Jaw Angle	Jaw Length (mm)	Length (in.)
MB547R	90°	40	7 1/4

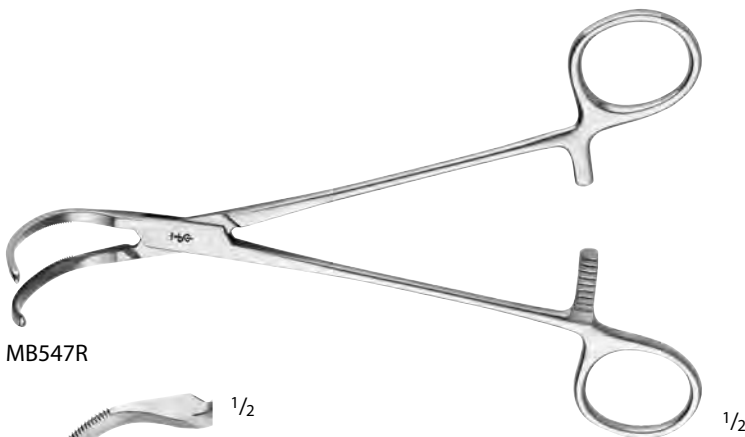

MB547R

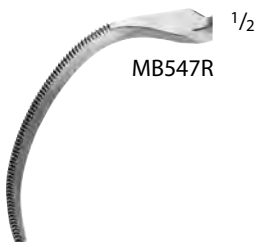

MB547R

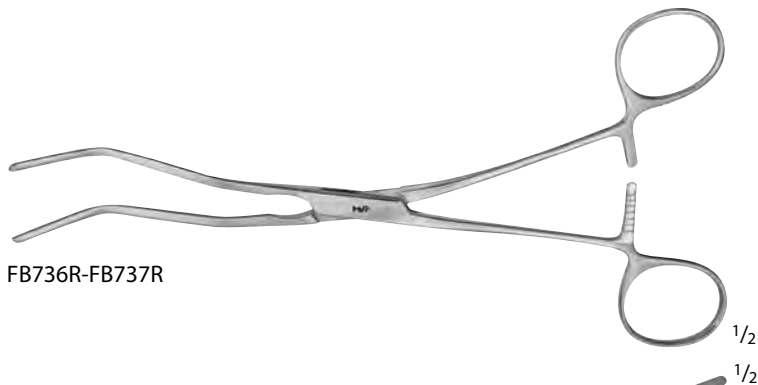

FB736R-FB737R

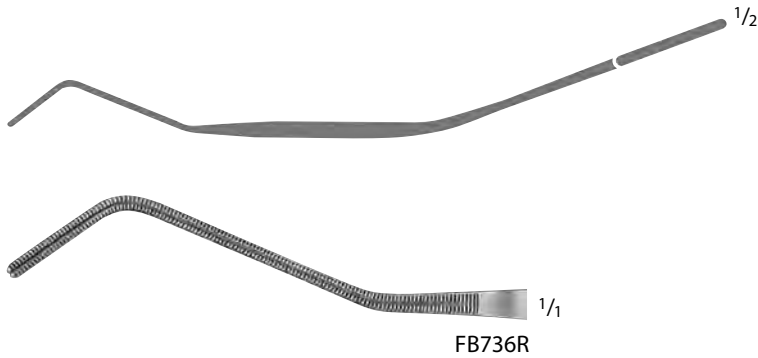

FB736R



FB737R

COOLEY Atraumatic Carotid and Subclavian Clamp

Catalog Number	Jaw Length (mm)	Length (in.)
FB736R	74	7 1/4
FB737R	86	7 3/4

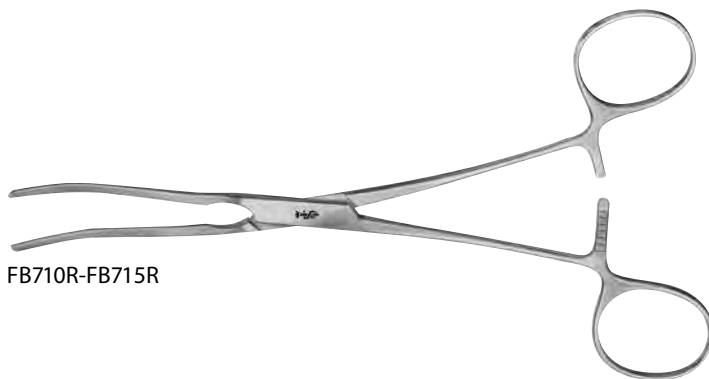

FB710R-FB715R



FB710R



FB712R

COOLEY Atraumatic Patent Ductus Clamp, Straight Shaft

Catalog Number	Jaw Length (mm)	Jaw	Length (in.)
FB710R	41	STR	6 1/4
FB712R	52	STR	6 3/4
FB713R	52	LIGHT-CVD	7
FB715R	63	S-CVD	7



FB713R



FB715R

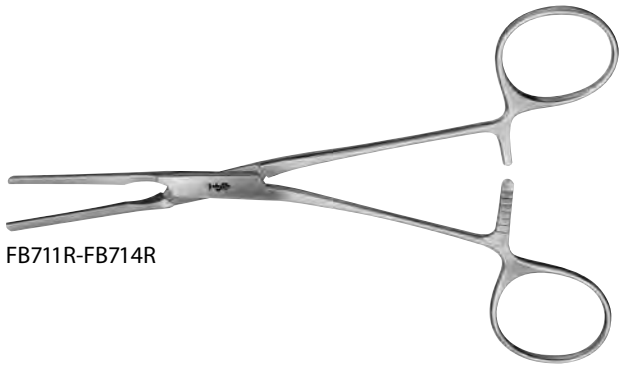

FB711R-FB714R



FB711R

COOLEY Atraumatic Patent Ductus
 Clamp, Angled Shaft

Catalog Number	Jaw Angle	Jaw Length (mm)	Length (in.)
FB711R	STR	41	6 1/4
FB714R	STR	52	6 3/4
FB754R	60°	57	6 1/2
FB755R	60°	67	6 3/4
FB756R	60°	82	7 1/4



FB714R



FB754R-FB756R

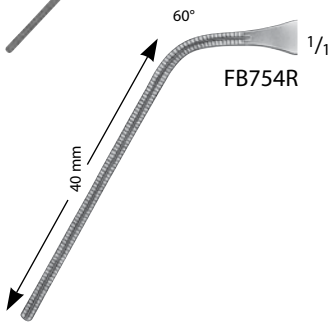
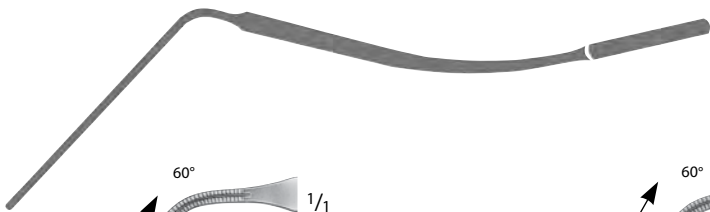

FB754R

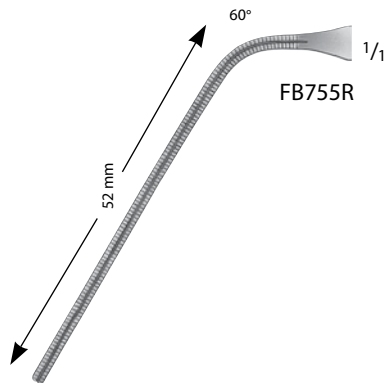

FB755R

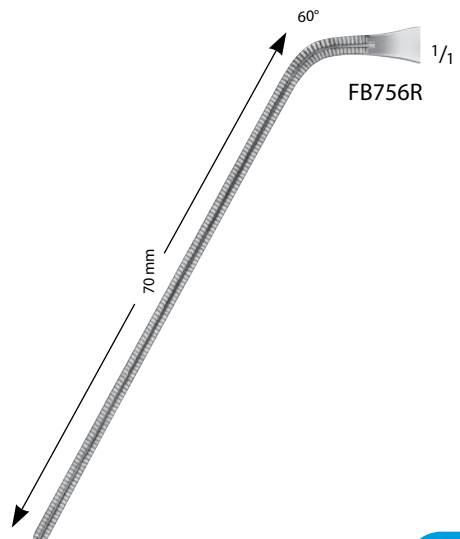

FB756R

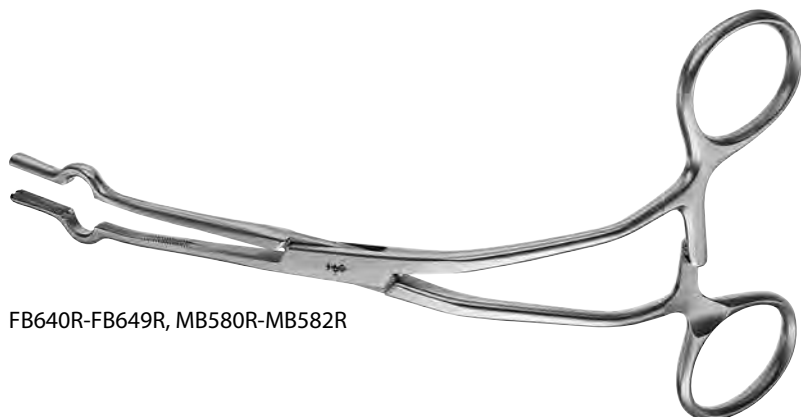

FB640R-FB649R, MB580R-MB582R

COOLEY Cava Occlusion Clamp

Catalog Number	Jaw Size (FR)	Length (in.)
FB640R	20	6 1/4
FB641R	24	6 1/4
FB642R	26	7 1/2
MB580R	28	7 1/2
FB644R	30	7 1/2
MB581R	32	7 1/2
MB582R	34	7 1/2
FB647R	36	7 1/2
FB649R	40	7 1/2



FB640R



FB642R



FB644R



MB582R



FB649R



FB641R



MB580R



MB581R



FB647R

Let Us know if you could not find what you are looking for

COOLEY Atraumatic Pediatric
 Anastomosis Clamp, Angled Shaft

Catalog Number	Jaw Length (mm)	Length (in.)
FB729R	17	6 3/4
FB721R	25	6 1/2
FB722R	28	6 1/2
FB723R	33	6 7/8
FB724R	36	7



FB729R

1/2



1/2

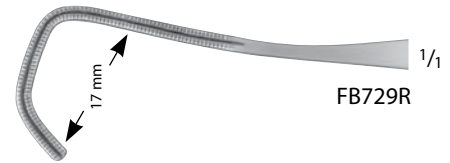

FB729R

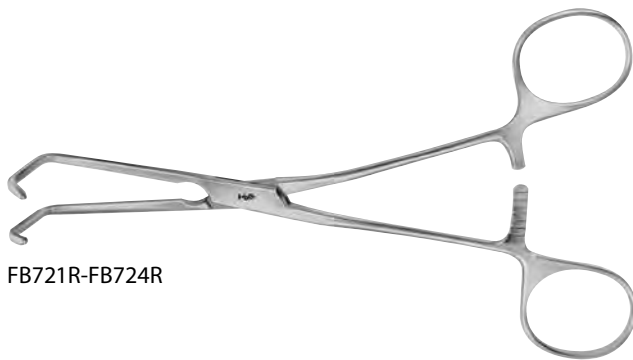

FB721R-FB724R

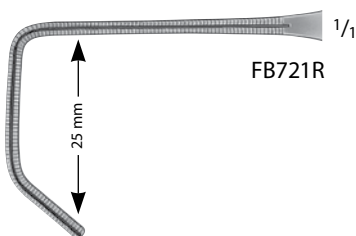

FB721R

1/1

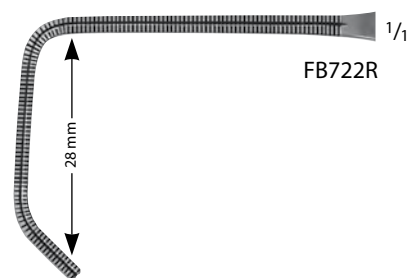

FB722R

1/1

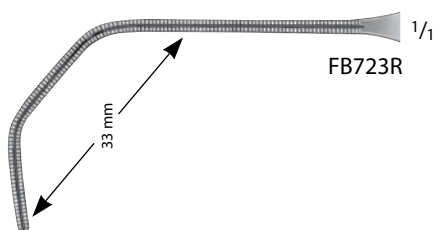

FB723R

1/1

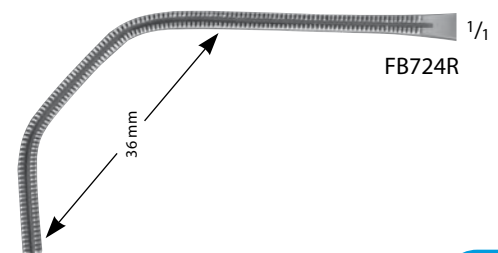

FB724R

1/1

Let Us know if you could not find what you are looking for

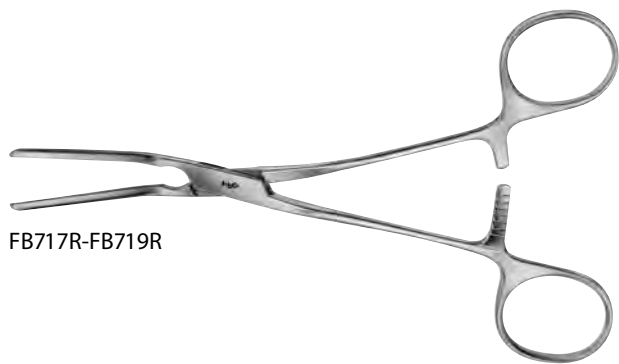

FB717R-FB719R

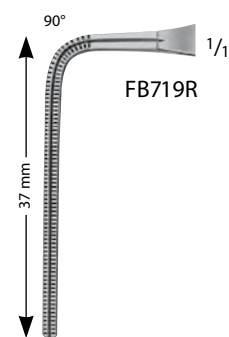
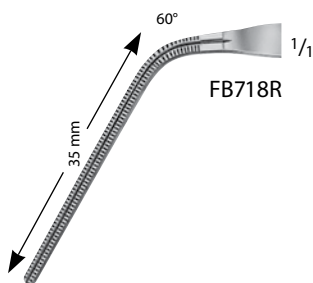
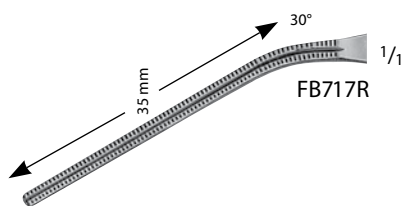

COOLEY Atraumatic Pediatric
 Multi-Purpose Clamp, Angled Shaft

Catalog Number	Jaw Angle	Jaw Length (mm)	Length (in.)
FB717R	30°	35	6 1/2
FB718R	60°	35	6 1/4
FB719R	90°	37	6



FB730R

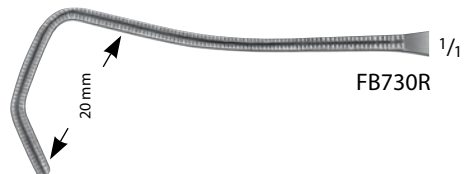
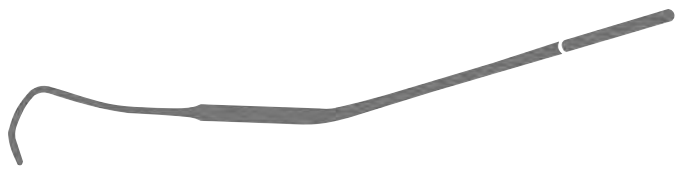

COOLEY Atraumatic Pediatric
 Anastomosis Clamp, Angled Shaft

Catalog Number	Jaw Length (mm)	Length (in.)
FB730R	20	6 7/8

COOLEY Atraumatic Renal Artery
 Clamp, Angled Shaft

Catalog Number	Jaw Length (mm)	Length (in.)
FB738R	108	10 1/4

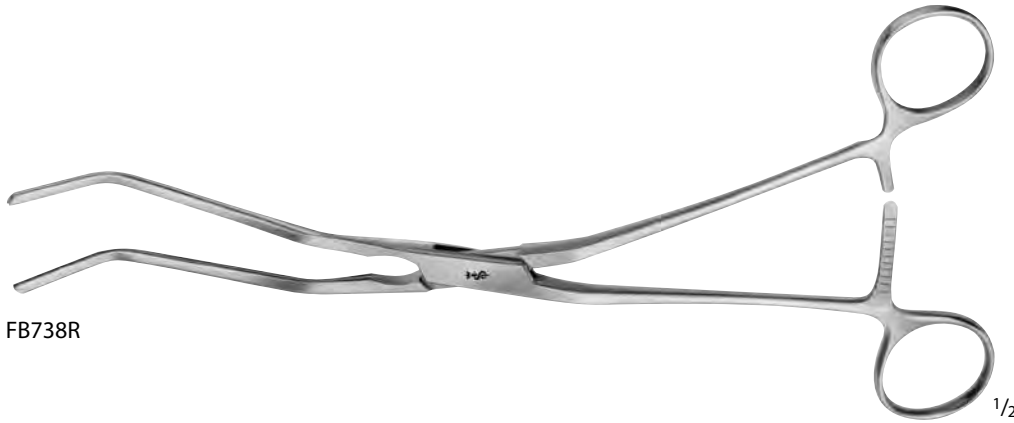

FB738R

1/2

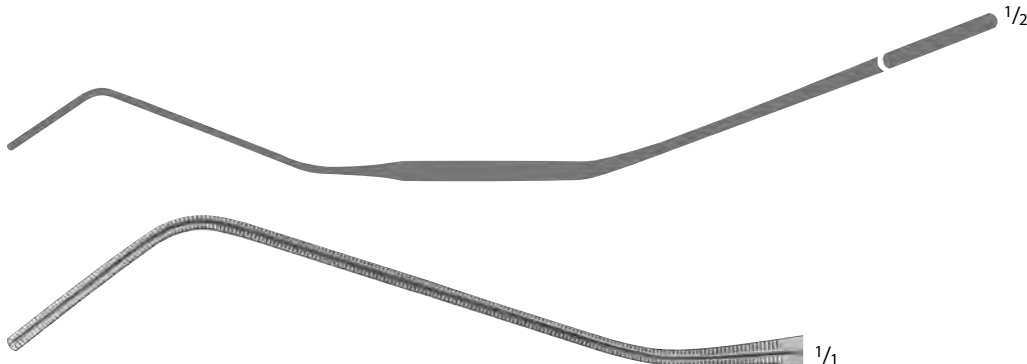

1/2

FB738R

1/1

COOLEY Atraumatic Aorta Clamp,
 Angled Shaft

Catalog Number	Jaw Length (mm)	Length (in.)
MB349R	73	10



MB349R

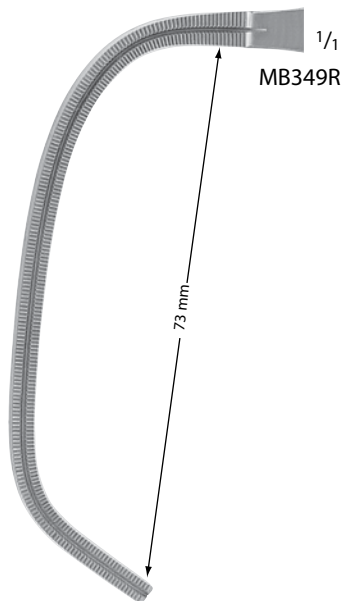

COOLEY Tangential Clamp, Calibrated

Catalog Number	Jaw (mm)	Length (in.)
MG456R	20 x 7	7 3/4
MG457R	25 x 8	7 7/8
MG458R	38 x 10	7 7/8

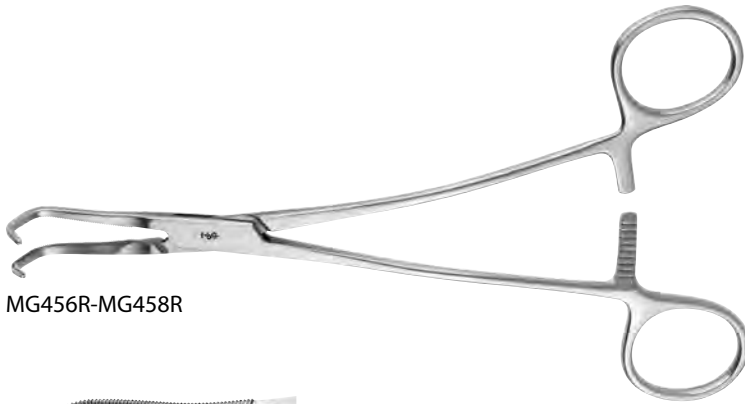

MG456R-MG458R



MG456R

1/1



MG457R

1/1



MG458R

1/1

COOLEY Atraumatic Forceps, S-Shaped

Catalog Number	Jaw Length (mm)	Length (in.)
FB764R	115	12 1/2

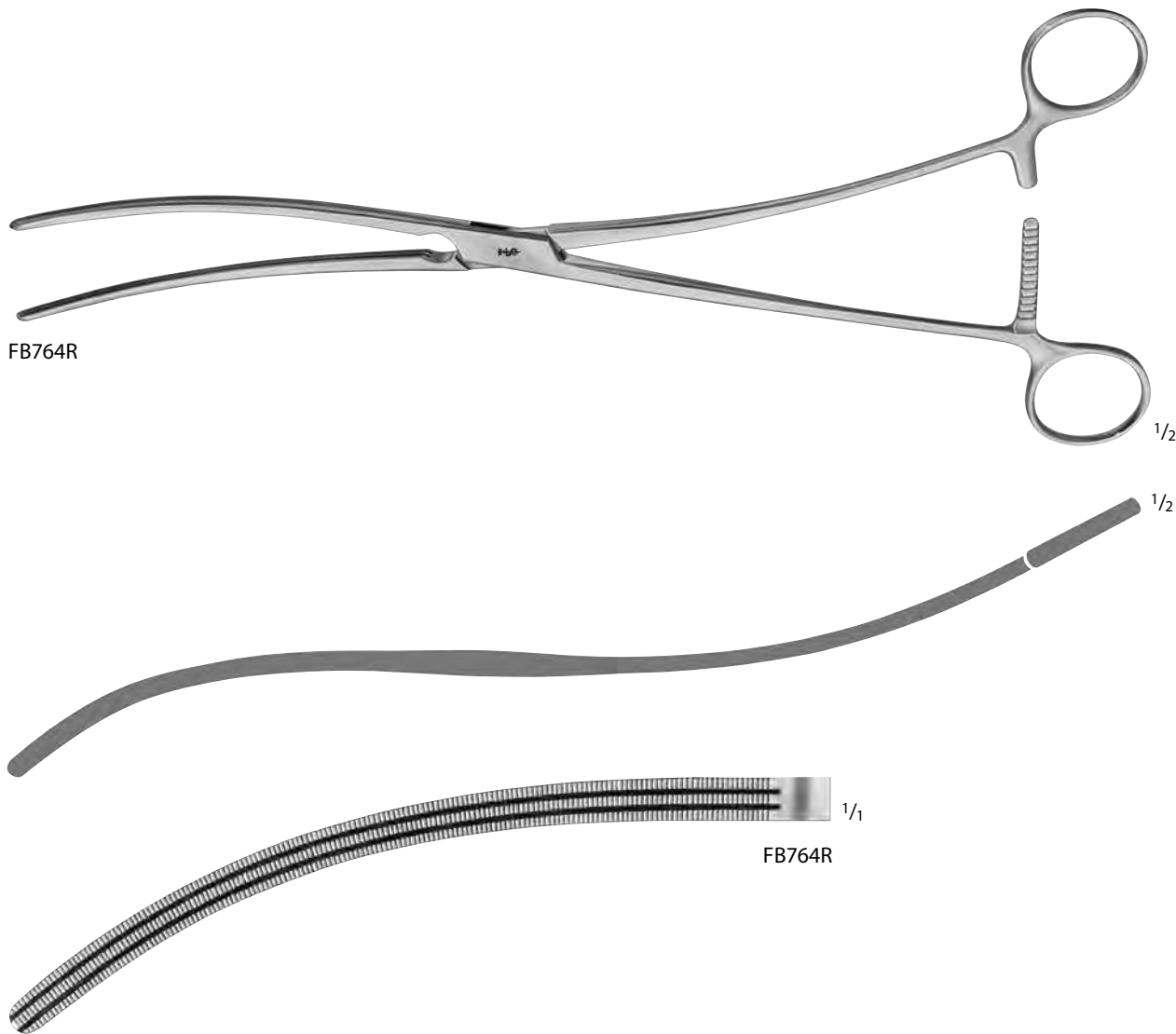

Let Us know if you could not find what you are looking for

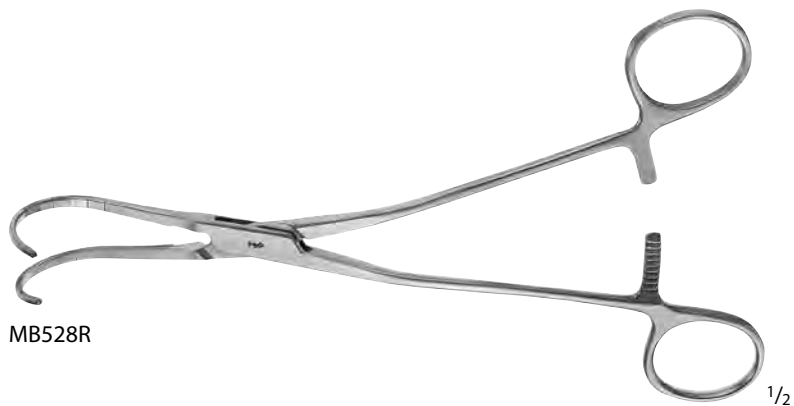

MB528R

COOLEY Atraumatic Multi-Purpose Clamp, Curved, Angled Shaft, Calibrated

Catalog Number	Jaw Length (mm)	Length (in.)
MB528R	32	8

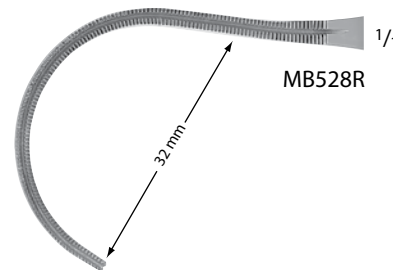

FB765R

COOLEY Atraumatic Forceps, Curved, Angled Shaft

Catalog Number	Jaw Length (mm)	Length (in.)
FB765R	82	11 1/4

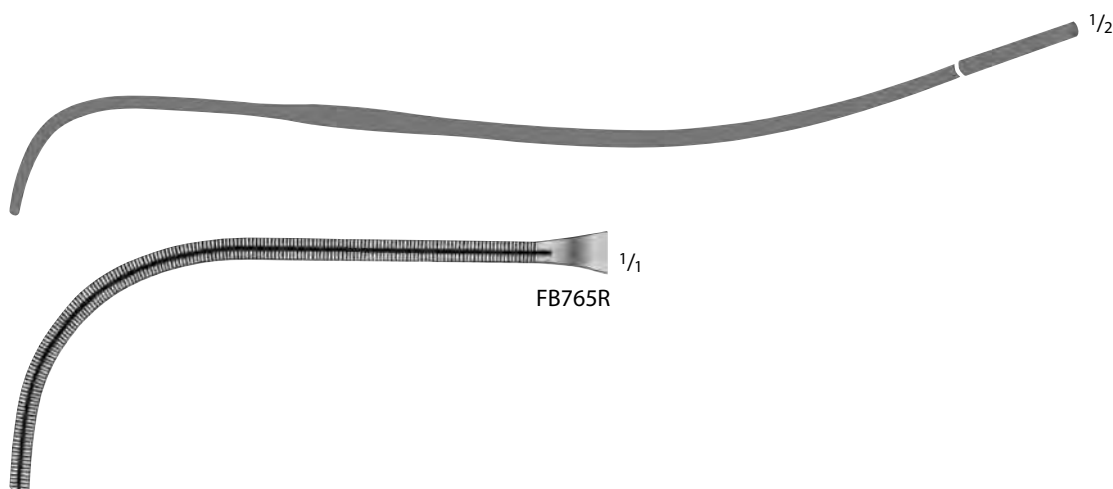

PARRY-COOLEY Atraumatic Forceps

Catalog Number	Jaw Length (mm)	Length (in.)
FB775R	70	11 5/8

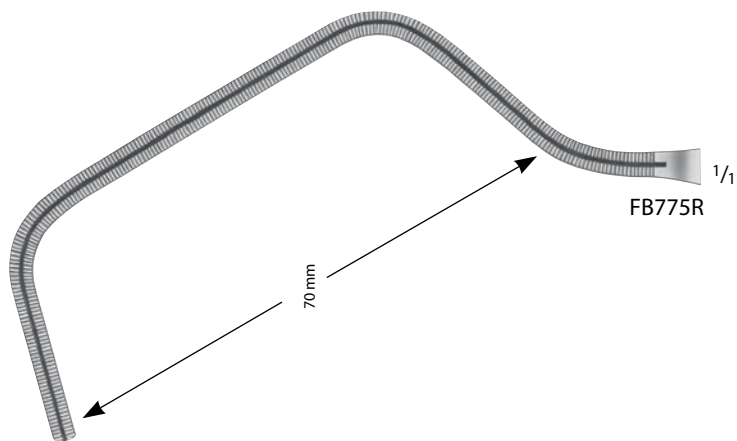
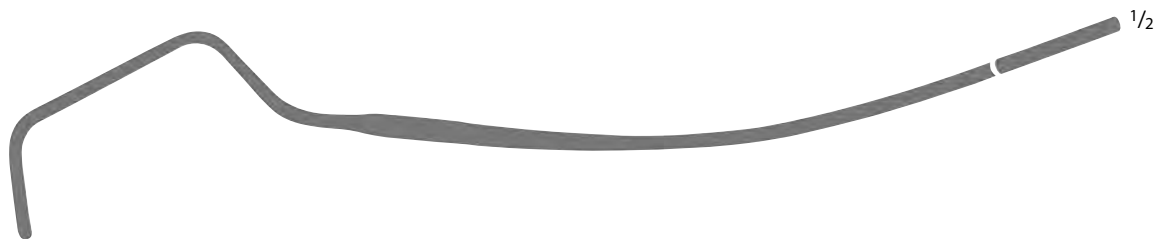

COOLEY Auricular Appendage Clamp

Catalog Number	Jaw	Length (in.)
MG451R	40 x 10	10

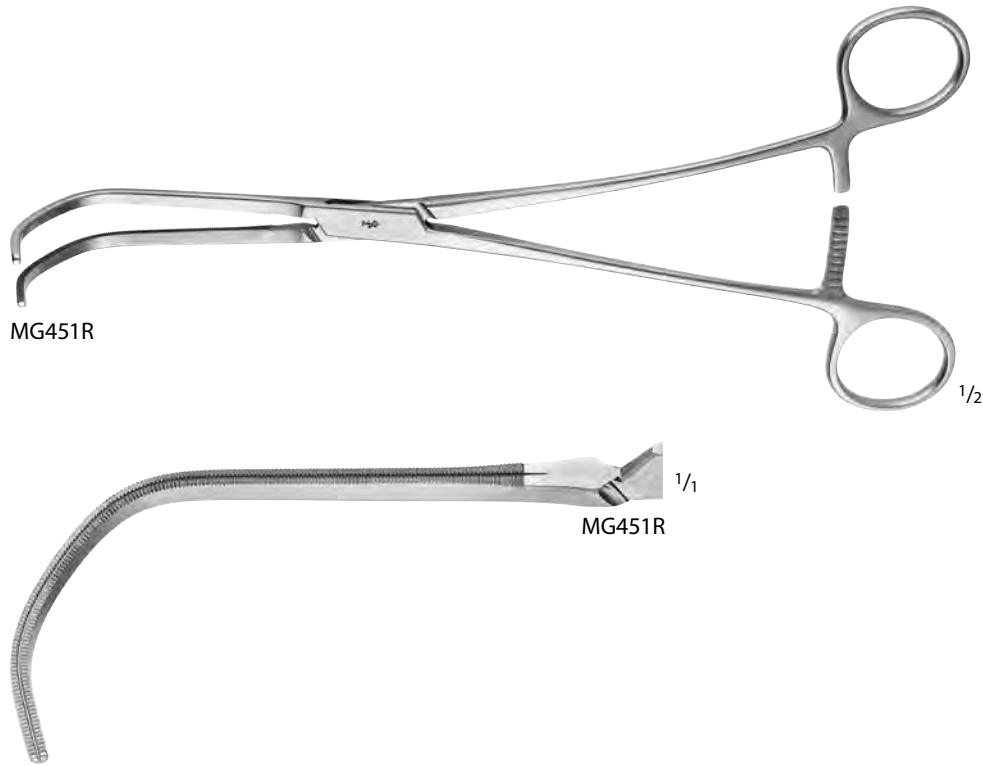

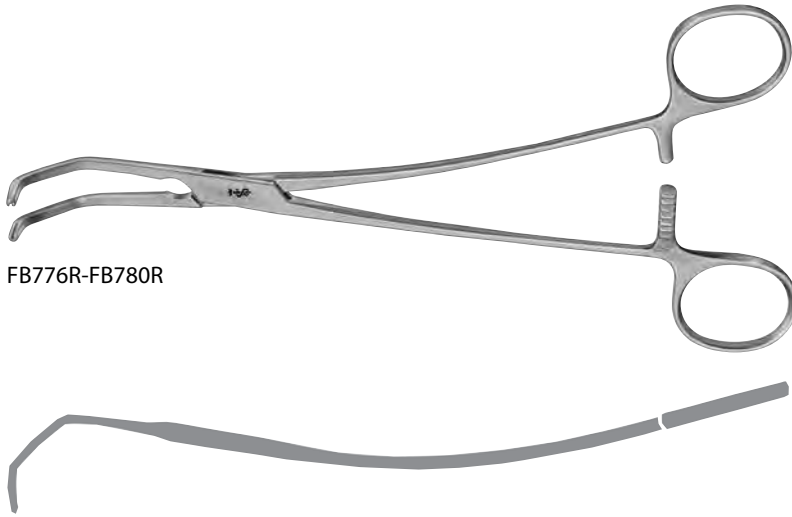

FB776R-FB780R

COOLEY Partial Occlusion Clamp

Catalog Number	Jaw Length (mm)	Length (in.)
FB776R	31	8
FB777R	44	10 1/4
FB778R	50	10 1/2
FB779R	63	10 1/2
FB780R	78	10 3/4

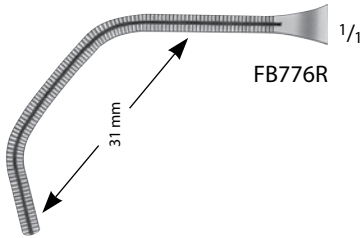

FB776R

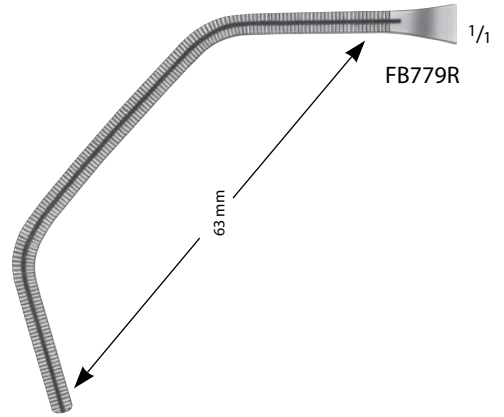

FB779R

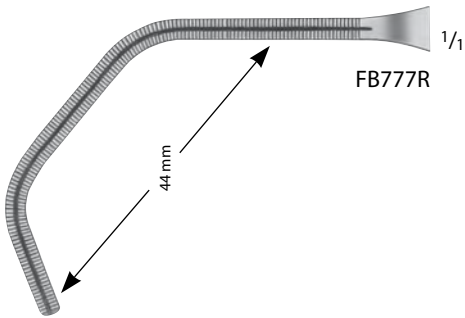

FB777R

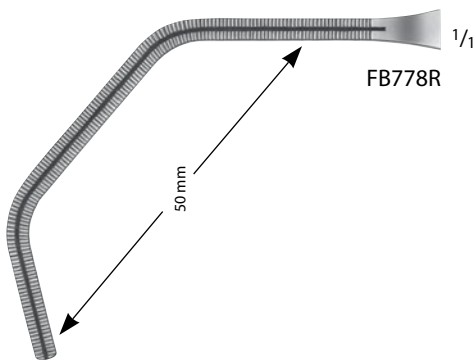

FB778R

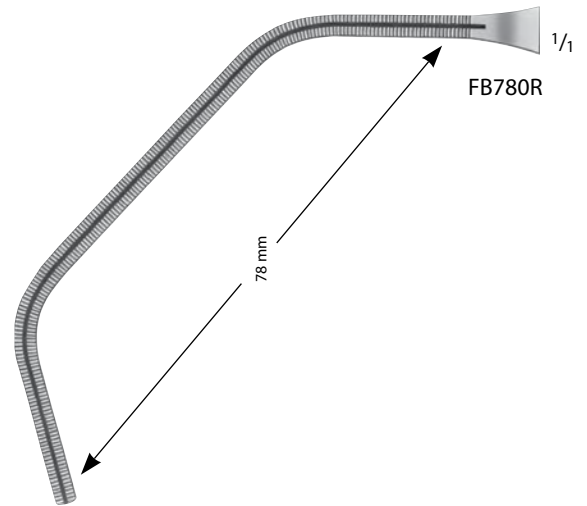

FB780R

Let Us know if you could not find what you are looking for

Atraumatic Multi-Purpose Clamp

Catalog Number	Jaw Length (mm)	Jaw	Length (in.)
FC310R	50	STR	6 3/4
FC311R	50	ANG 15°	6 3/4
FC312R	50	ANG 30°	6 3/4
FC313R	50	ANG 45°	6 1/4

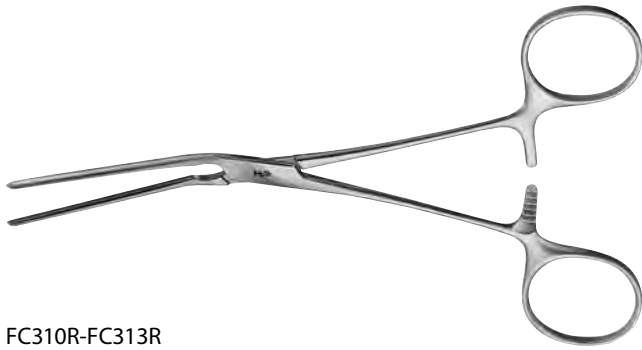

FC310R-FC313R



50 mm

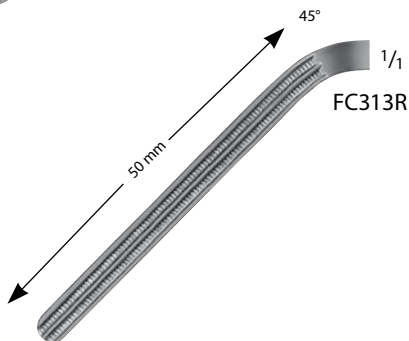
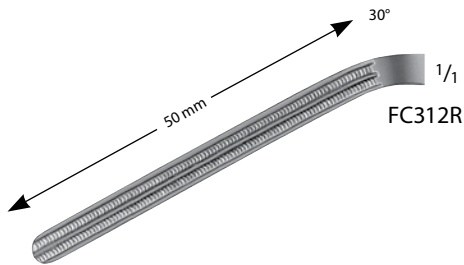
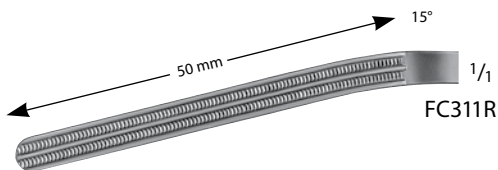
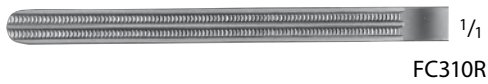

KLINTMALM Liver Transplant Clamp

Catalog Number	Jaw Length (mm)	Length (in.)
MG073R	95	9 3/4

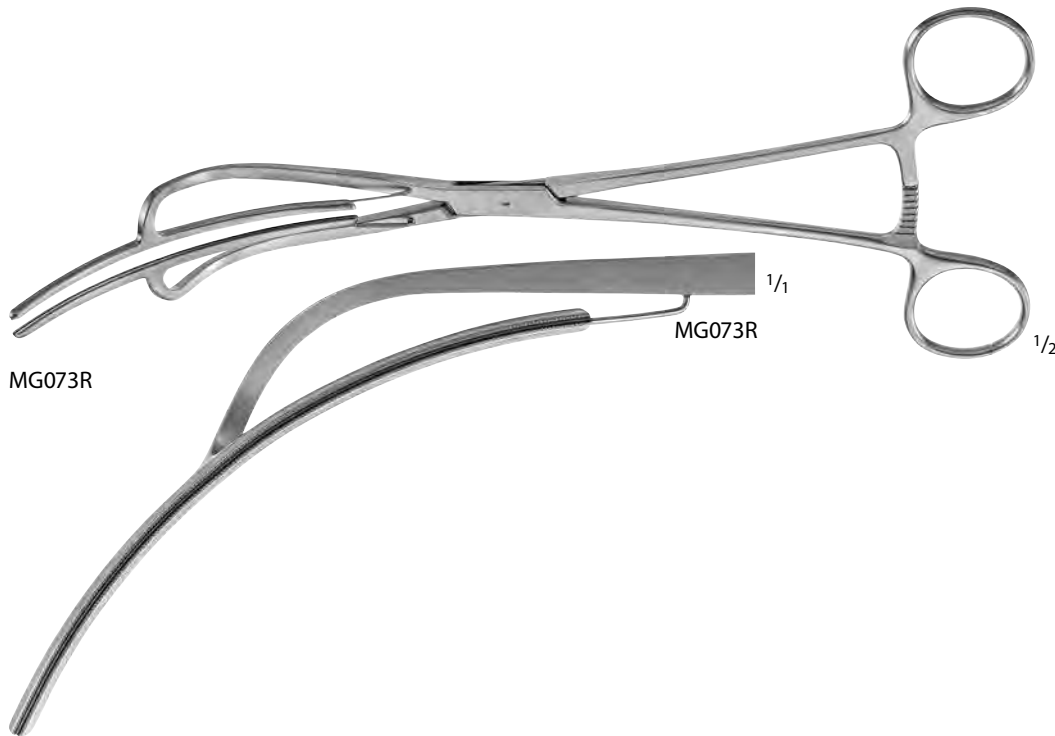

KITZMILLER Clamp

Catalog Number	Jaw	Jaw Length (mm)	Length (in.)
MG012R	ANG LEFT	10	5 1/4
MG013R	ANG RIGHT	10	5 1/4

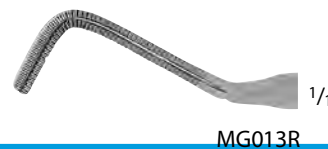
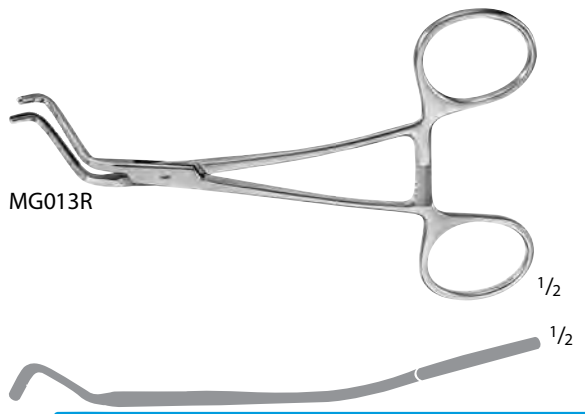
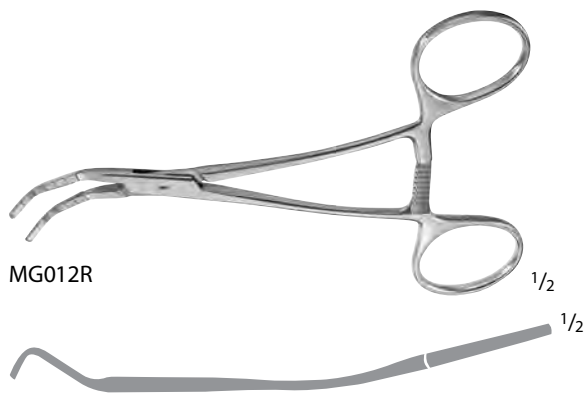

POTTS Liver Clamp W/ Teeth

Catalog Number	Size	Length (in.)
MB481R	SMALL	10
MB482R	MEDIUM	10 1/4
MB483R	LARGE	10 5/8



MB481R-MB483R

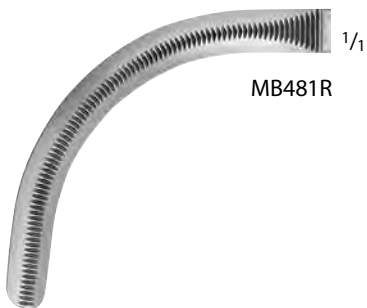

MB481R

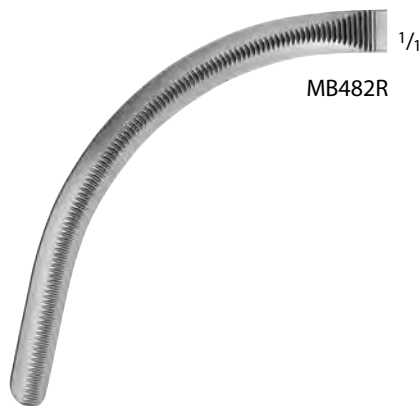

MB482R

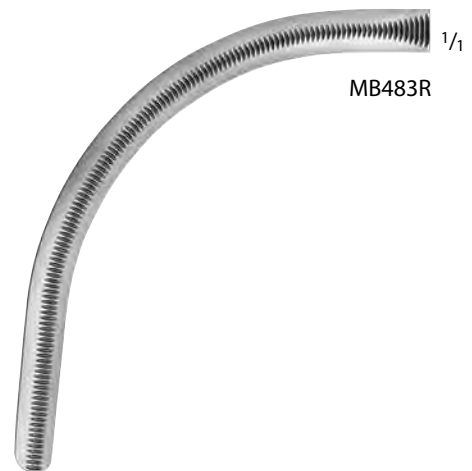

MB483R

PARSONNET Aorta Clamp

Catalog Number	Jaw Length (mm)	Length (in.)
MB671R	28	9 3/8
MB672R	32	9 5/8
MB673R	38	9 5/8
MB674R	45	10



MB671R-MB674R



MB671R

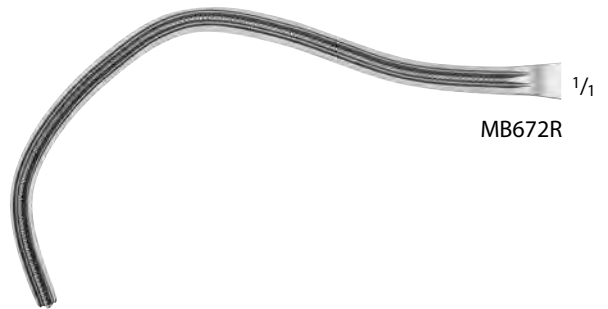

MB672R

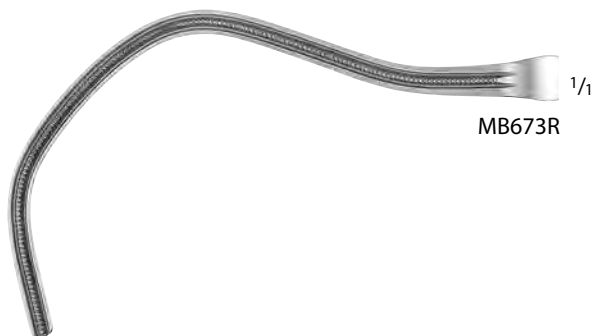

MB673R



MB674R

Let Us know if you could not find what you are looking for

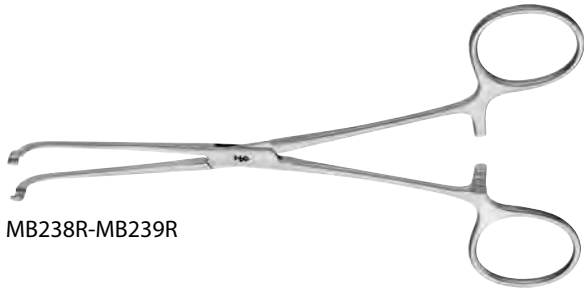

MB238R-MB239R

JAVID Carotid Artery Bypass
 Shunt Clamp

Catalog Number	Jaw	Length (in.)
MB238R	4 MM RING	6 5/8
MB239R	6 MM RING	7



MB238R

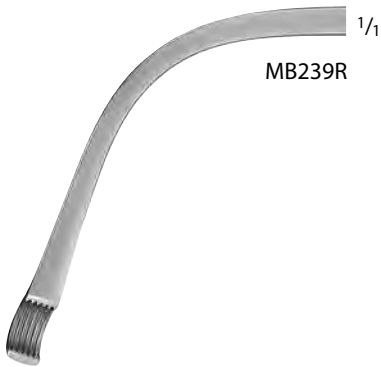

MB239R

JOHNS-HOPKINS Apply/Remove Forceps

Catalog Number	Length (in.)
BH018R	9 1/2

Forceps for applying and removing bulldog clamps BH011R - BH031R and FB420R - FB427R



BH018R



BH011R-BH017R

JOHNS-HOPKINS Bulldog Clamp

Catalog Number	Jaw	Jaw Length (mm)	Length (in.)
BH011R	CVD	12	1 1/2
BH012R	CVD	17	1 7/8
BH013R	CVD	25	2 1/8
BH014R	CVD	30	2 1/2
BH015R	CVD	33	2 3/4
BH016R	CVD	42	3 1/8
BH017R	CVD	52	3 1/2



BH020R



BH026R



BH021R



BH027R

DIEFFENBACH Bulldog Clamp

Catalog Number	Jaw	Jaw Length (mm)	Length (in.)
BH020R	STR	12	1 1/2
BH022R	STR	16	1 7/8
BH026R	STR	16	2 1/8
BH021R	CVD	12	1 1/2
BH023R	CVD	16	1 7/8
BH027R	CVD	16	2 1/8



Bulldog Clamp, Lightweight

Catalog Number	Jaw	Jaw Length (mm)	Length (in.)
MG082R	STR	18	1 1/2
MG083R	ANG	18	1 3/8
MG084R	ANG	21	1 1/2

DEBAKEY-HESS Bulldog Clamp

Catalog Number	Jaw	Jaw Length (mm)	Length (in.)
BH030R	ANG	20	1 3/8
BH031R	ANG	30	1 1/2

GREGORY-DEBAKEY Bulldog Clamp

Catalog Number	Jaw	Jaw Length (mm)	Length (in.)
MB523R	ANG	70	4 3/4

GREGORY Mini-Bulldog Clamp

Catalog Number	Jaw Length (mm)	Jaw	Length (in.)
FB382R	50	ANG	4 1/8
FB383R	65	ANG	4 3/4

Let Us know if you could not find what you are looking for



GREGORY Mini-Bulldog Clamp

Catalog Number	Jaw	Jaw Length (mm)	Length (in.)
FB384R	CVD-LEFT	70	4 3/4
FB385R	CVD-RIGHT	70	4 3/4

FB384R-FB385R



1/1

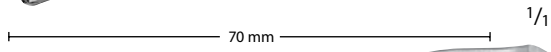

1/1



FB384R



1/1



1/1

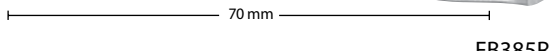

FB385R



FB420R, FB422R, FB424R, FB426R



FB421R, FB423R, FB425R, FB427R



FB328R



FB330R



FB329R



FB331R



MB741R



MB285R



BH032R



BH034R

DEBAKEY Atraumatic Mini-Bulldog
 Clamp

Catalog Number	Jaw	Jaw Length (mm)	Length (in.)
FB420R	STR	20	3 1/8
FB422R	STR	30	3 1/2
FB424R	STR	45	4 1/8
FB426R	STR	65	5
FB421R	CVD	20	3 1/8
FB423R	CVD	30	3 1/4
FB425R	CVD	45	3 3/4
FB427R	CVD	65	4 1/2

Atraumatic Mini-Bulldog Clamp

Catalog Number	Jaw	Jaw Length (mm)	Length (in.)
FB328R	STR	14	1 3/8
FB330R	STR	19	1 3/4
FB329R	CVD	14	1 3/8
FB331R	CVD	19	1 3/4

DIETHRICH Micro Bulldog Clamp

Catalog Number	Jaw	Jaw Length (mm)	Length (in.)
MB741R	STR	16	2
MB285R	STR	20	2 1/4
BH032R	ANG	10	1 7/8
BH034R	ANG	13	1 7/8



FB352R



FB353R



FB357R

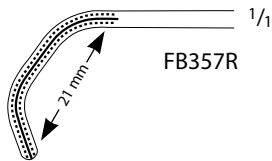

FB358R

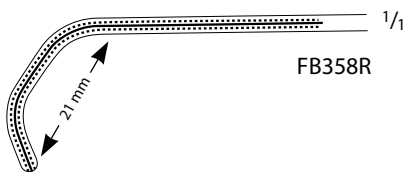

FB359R

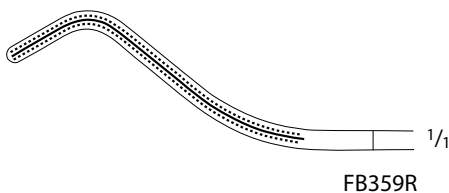

DEBAKEY Atraumatic Mini-Bulldog
 Clamp

Catalog Number	Jaw Angle	Jaw Length (mm)	Length (in.)
FB352R	STR	20	2
FB353R	CVD	20	1 7/8
FB357R	MULTI	21	3
FB358R	MULTI	42	4
FB359R	S-SHAPED	38	3 3/4



FB431R



FB432R, FB434R, FB436R



FB433R, FB435R, FB437R



MB737R-MB740R



MB586R-MB589R

GLOVER Atraumatic Mini-Bulldog Clamp

Catalog Number	Jaw Angle	Jaw Length (mm)	Length (in.)
FB431R	75°	20	2
FB432R	STR	25	2 3/4
FB434R	STR	40	3 3/4
FB436R	STR	60	4 1/2
FB433R	CVD	25	2 1/2
FB435R	CVD	40	3 1/2
FB437R	CVD	60	4 1/4

COOLEY Atraumatic Bulldog Clamp

Catalog Number	Jaw	Jaw Length (mm)	Length (in.)
MB737R	STR	20	2
MB738R	STR	30	2 1/2
MB739R	STR	45	3 1/4
MB740R	STR	60	5
MB586R	CVD	44	1 3/4
MB587R	CVD	64	2 1/2
MB588R	CVD	75	3 1/8
MB589R	CVD	60	4 3/4



FB370R

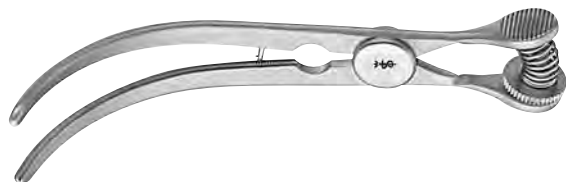

FB374R-FB376R



FB377R

GLOVER Atraumatic Bulldog Clamp

Catalog Number	Jaw	Jaw Length (mm)	Length (in.)
FB370R	STR	25	2
FB374R	CVD	20	1 1/2
FB375R	CVD	30	2 3/8
FB376R	CVD	45	3
FB377R	CVD	55	4 3/4



FD628R

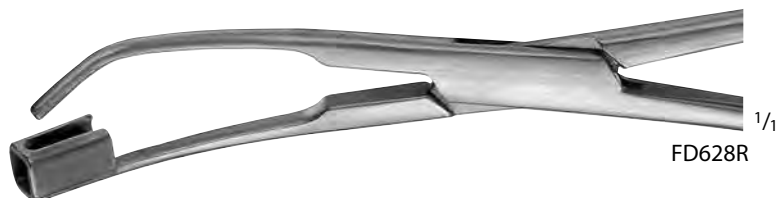

FD628R

SCHWARTZ Apply/Remove Forceps

Catalog Number	Length (in.)
FD628R	7 1/2



FD622R

FD623R

FD624R

SCHWARTZ Micro-Vessel Clamp,
 Cross-Serrated

Catalog Number	Jaw	Jaw Length (mm)	Closing Force	Length (in.)
FD622R	STR	8	400G	1
FD623R	25°	8	400G	1
FD624R	45°	8	400G	1

Let Us know if you could not find what you are looking for



1/1

FE010K, FE020K

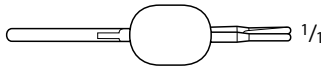

1/1

FE010K, FE020K



1/1

FE011K, FE021K

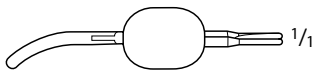

1/1

FE011K, FE021K



1/1

FE012K, FE022K

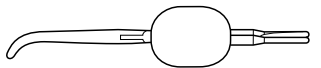

1/1

FE012K, FE022K



1/1

FE013K, FE023K

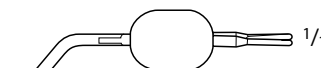

1/1

FE013K, FE023K



1/1

FE014K, FE024K



1/1

FE014K, FE024K



1/1

FE005K



1/1

FE005K

MUELLER Atraumatic Micro-Vessel Clamp

Catalog Number	Jaw	Closing Force
FE010K	STR	50G
FE020K	STR	80G
FE011K	FULL-CVD	50G
FE021K	FULL-CVD	80G
FE012K	CVD-TIP	50G
FE022K	CVD-TIP	80G
FE013K	ANG	50G
FE023K	ANG	80G
FE014K	LAT-ANG	50G
FE024K	LAT-ANG	80G

MUELLER Ligature Forceps

Catalog Number	Jaw
FE005K	STR



FE031S, FE041S



FE032S, FE042S



FE030S, FE040S



FE034S, FE044S

MUELLER Alpha Vessel Clamp

Catalog Number	Jaw	Closing Force
FE031S	SLIGHT-CVD	250G
FE041S	SLIGHT-CVD	350G
FE032S	CVD	250G
FE042S	CVD	350G
FE030S	ANG	250G
FE040S	ANG	350G
FE034S	KNEE-BENT	250G
FE044S	KNEE-BENT	350G



NABATOFF Vein Stripper Set

Catalog Number	Description
FB031R	METAL CASE
FB040R	HANDLE
FB033	PLASTIC PROBE TIP
FB034R	METAL PROBE TIP, 3 MM
FB035R	METAL OLIVE, 6 MM
FB036R	METAL OLIVE, 9 MM
FB037R	METAL OLIVE, 12 MM
FB038R	METAL OLIVE, 15 MM



NABATOFF Mini Vein Stripper Set

Catalog Number	Description
FB031R	METAL CASE
FB053R	METAL OLIVE, 3 MM
FB054R	METAL OLIVE, 4 MM
FB055R	METAL OLIVE, 5 MM





VARADY Varix Dissector, Double Ended

Catalog Number	Tip Size (mm)	Length (in.)
FB120R	0.30 / 0.30	7



VARADY Varix Extractor, Double Ended W/ Hook

Catalog Number	Tip Size (mm)	Length (in.)
FB125R	0.25 / 0.40	6 3/4
FB122R	0.75 / 0.60	7
FB121R	0.75 / 1.2	7



VARADY Mini-Varix Extractor, Double Ended W/ Hook

Catalog Number	Tip Size (mm)	Length (in.)
FB126R	0.35 / 0.50	6 3/4



VARADY Micro Spatula, Double Ended

Catalog Number	Tip Size (mm)	Length (in.)
FB124R	0.35 / 0.25	6 7/8



Enderterectomy Stripper

Catalog Number	Tip Size (mm)	Length (in.)
FB108R	2	21 3/4
FB109R	3	21 3/4
FB110R	4	21 3/4
FB112R	6	21 3/4
FB113R	7	21 3/4
FB114R	8.5	21 3/4
FB115R	10	21 3/4
FB116R	12	21 3/4
FB117R	14	21 3/4
FB119R	-	4 1/4

FB119R is the handle for FB108R-FB117R

FB108R-FB117R

○ 1/1

FB108R

○ 1/1

FB109R

○ 1/1

FB110R

○ 1/1

FB112R

○ 1/1

FB113R

○ 1/1

FB114R

○ 1/1

FB115R

○ 1/1

FB116R

○ 1/1

FB117R



FB119R

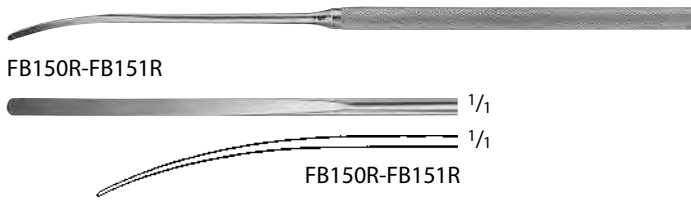

FB150R-FB151R

1/1

1/1

FB150R-FB151R



MB063R

1/1

MB063R



FB160R-FB172R, MG008R-MG010R

1/1

FB160R

1/1

FB161R

1/1

FB162R

1/1

FB163R

1/1

FB164R

1/1

FB165R

1/1

FB166R

1/1

FB167R

1/1

FB168R

1/1

FB169R

1/1

MG008R

1/1

FB170R

1/1

MG009R

1/1

FB172R

1/1

MG010R

Vascular Spatula, Blunt, 3 mm

Catalog Number	Length (in.)
FB150R	7 1/4
FB151R	8 1/2

JACOBSON Endarterectomy Spatula

Catalog Number	Length (in.)
MB063R	7

DEBAKEY Vascular Dilator, Malleable

Catalog Number	Tip Size (mm)	Length (in.)
MG011R	SET OF 12	-
MG055R	SET OF 5	-
FB160R	0.5	7 1/2
FB161R	1.0	7 1/2
FB162R	1.5	7 1/2
FB163R	2.0	7 1/2
FB164R	2.5	7 1/2
FB165R	3.0	7 1/2
FB166R	3.5	7 1/2
FB167R	4.0	7 1/2
FB168R	4.5	7 1/2
FB169R	5.0	7 1/2
MG008R	6.0	7 1/2
FB170R	7.0	7 1/2
MG009R	8.0	7 1/2
FB172R	9.0	7 1/2
MG010R	10.0	7 1/2

MG011R Includes:

1 Dilator of each FB161R-165R, FB167R, FB169R, MG008R, FB170R, MG009R, FB172R, MG010R

MG055R Includes:

1 Dilator of each FB161R-165R



MB246-MB254



MB246



MB247



MB248



MB249



MB250



MB251



MB252

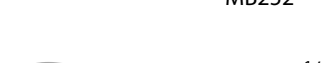

MB253



MB254



MB255

GARRETT Vascular Dilator

Catalog Number	Tip Size (mm)	Length (in.)
MB245	COMPLETE SET	5 1/2
MB246	1.0	5 1/2
MB247	1.5	5 1/2
MB248	2.0	5 1/2
MB249	2.5	5 1/2
MB250	3.0	5 1/2
MB251	3.5	5 1/2
MB252	4.0	5 1/2
MB253	4.5	5 1/2
MB254	5.0	5 1/2
MB255	TUBE	5 1/2

MB245 Includes:

1 Dilator of each MB246-MB254

MB255:

Tube for GARRETT Vascular Dilators
 MB245-MB254

Let Us know if you could not find what you are looking for

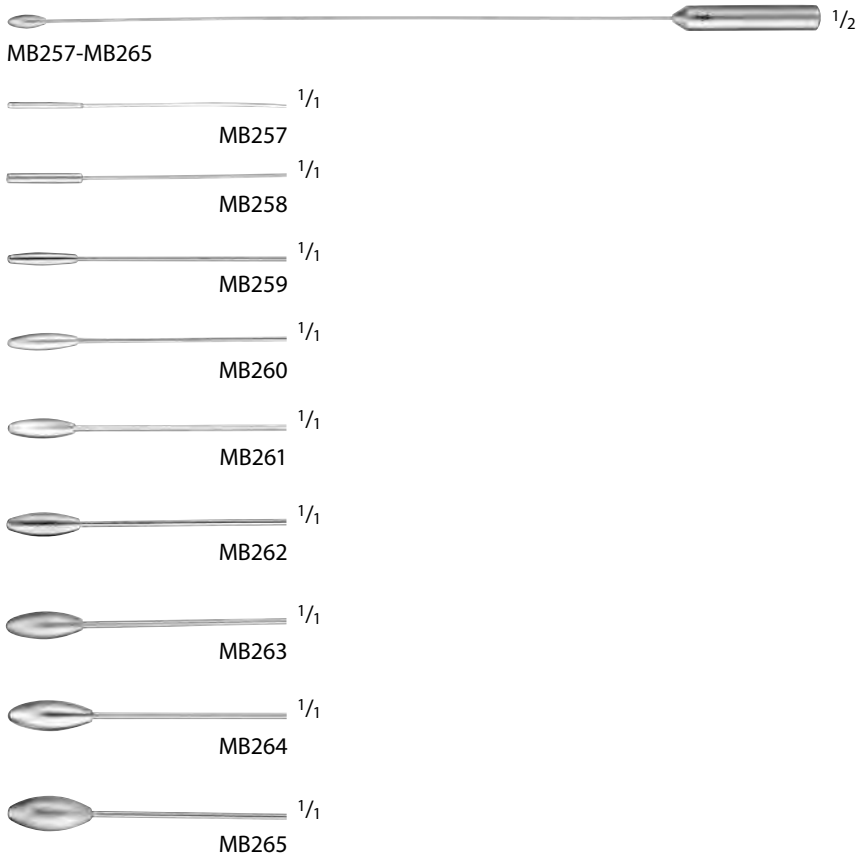

GARRETT Vascular Dilator

Catalog Number	Tip Size (mm)	Length (in.)
MB256	COMPLETE SET	8 1/2
MB257	1.0	8 1/2
MB258	1.5	8 1/2
MB259	2.0	8 1/2
MB260	2.5	8 1/2
MB261	3.0	8 1/2
MB262	3.5	8 1/2
MB263	4.0	8 1/2
MB264	4.5	8 1/2
MB265	5.0	8 1/2
MB266	TUBE	8 1/2

MB256 Includes:
 1 Dilator of each MB257-MB265

MB266:
 Tube for GARRETT Vascular Dilator

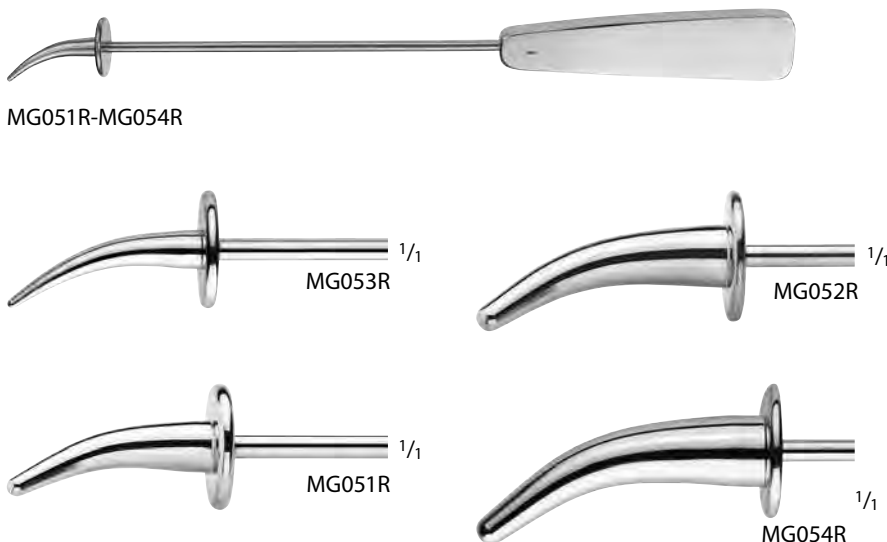

Aortic Arch Dilator

Catalog Number	Tip Size (mm)	Length (in.)
MG053R	5	8
MG051R	6	8
MG052R	8	8
MG054R	9.5	8

Let Us know if you could not find what you are looking for



FB153R-FB156R



FB153R



FB154R



FB155R



FB156R



MD610-MD611



MB601R



MB602R



MB634R

SCHMID Vessel Irrigation Cannula,
 Silver Plated

Catalog Number	Tip Size (mm)	Length (in.)
FB153R	3	6
FB154R	4	6
FB155R	5	6
FB156R	6	6

Heparin Needle

Catalog Number	Gauge	Length (in.)
MD610	13	3 1/2
MD611	18	3 3/4

ZANGER Heparin Cannula, Malleable

Catalog Number	Tip Size (mm)	Length (in.)
MB601R	3.5	2 3/4

IMA Heparin Cannula, Malleable

Catalog Number	Tip Size (mm)	Length (in.)
MB602R	1.5	2 1/8

Luer Lock Adapter

Catalog Number	Length (in.)
MB634R	1 1/2



FK340R

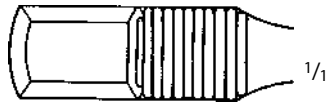
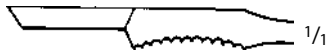

FK340R



FK341R

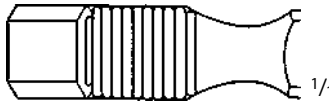
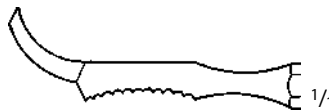

FK341R



FK344R

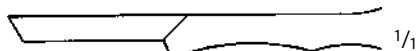

FK344R



FK345R

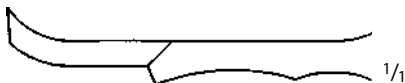

FK345R

FARABEUFG Elevator

Catalog Number	Tip Size (mm)	Blade Shape	Length (in.)
FK340R	12.5	STR	5 3/4
FK341R	12.5	CVD	5 1/4

FARABEUFG-COLLIN Elevator

Catalog Number	Tip Size (mm)	Blade Shape	Length (in.)
FK344R	11	STR	6 1/4
FK345R	11	CVD	6 1/4



MB812R

MATSON Rib Stripper/Elevator

Catalog Number	Length (in.)
MB812R	8 3/4



FK355R-FK359R

LAMBOTTE Rib Elevator

Catalog Number	Tip Size (mm)	Length (in.)
FK355R	5	8 1/2
FK356R	10	8 1/2
FK357R	15	8 1/2
FK358R	20	8 1/2
FK359R	25	8 1/2

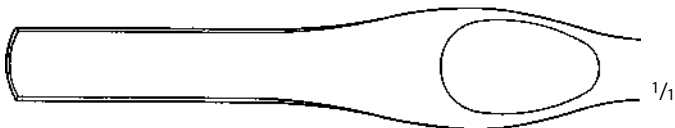
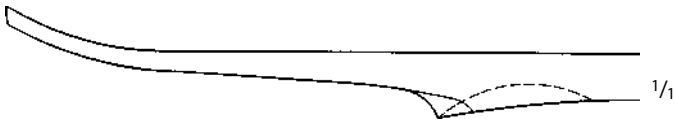

FK355R-FK359R



FK381R-FK387R

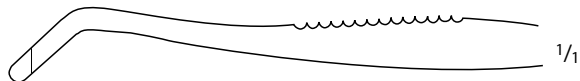

FK381R

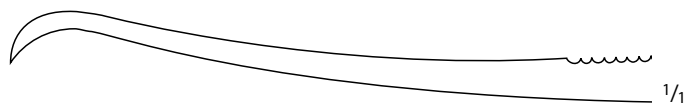

FK382R

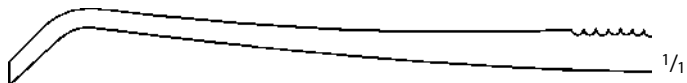

FK383R

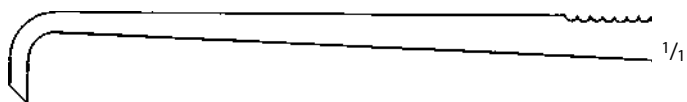

FK384R

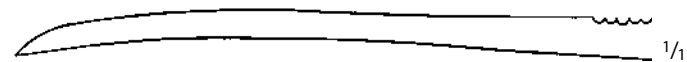

FK387R

SEMB Elevator

Catalog Number	Tip Size (mm)	Length (in.)
FK381R	12	7 1/2
FK382R	12	9
FK383R	13	9
FK384R	13	9
FK387R	15	9

DOYEN Elevator

Catalog Number	Blade End	Blade Shape	Length (in.)
FK400R	PEDIATRIC	LEFT-CVD	6 7/8
FK402R	ADULT	LEFT-CVD	6 7/8
FK401R	PEDIATRIC	RIGHT-CVD	6 7/8
FK403R	ADULT	RIGHT-CVD	6 7/8
FK408R	-	LEFT-CVD	9 1/2
FK409R	-	RIGHT-CVD	9 1/2



FK400R-FK402R

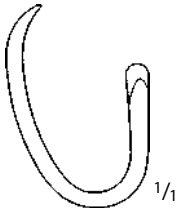

FK400R

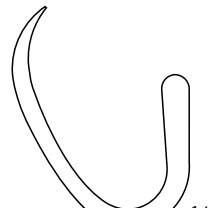

FK402R



FK401R-FK403R

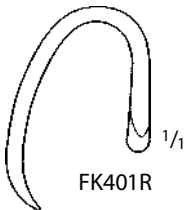

FK401R

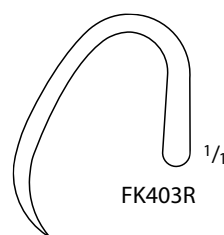

FK403R



FK408R

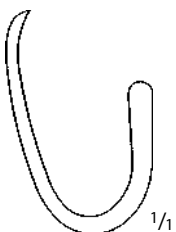

FK408R



FK409R

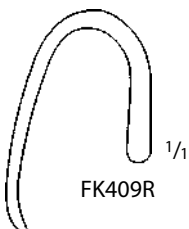

FK409R



FK420R

ALEXANDER Elevator

Catalog Number	Tip Size (mm)	Length (in.)
FK420R	12	8 1/4

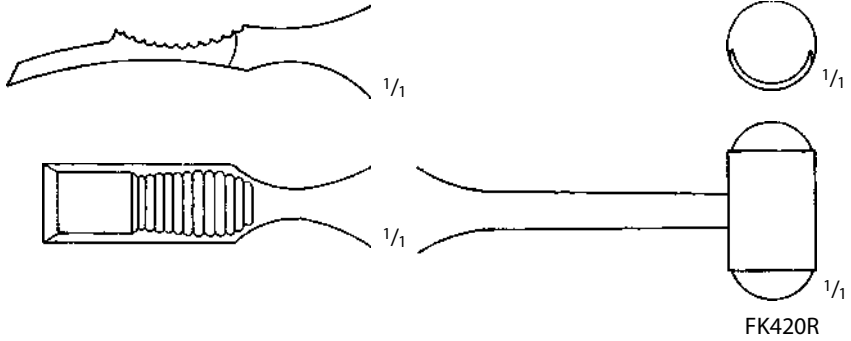

FB870R

Rib Shears

Catalog Number	Blade	Length (in.)
FB870R	S/B	9



FB873R

GLUCK Rib Shears

Catalog Number	Length (in.)
FB873R	7 1/2



FB878R

BETHUNE Rib Shears

Catalog Number	Length (in.)
FB878R	13 3/8



FB881R-FB882R

SAUERBRUCH Rib Shears

Catalog Number	Size	Length (in.)
FB881R	PEDIATRIC	9 1/2
FB882R	ADULT	10 5/8



FB890R

GIERTZ-STILLE Rib Shears

Catalog Number	Length (in.)
FB890R	9 3/4



MG094R

SWEET Sternum Punch

Catalog Number	Length (in.)
MG094R	10

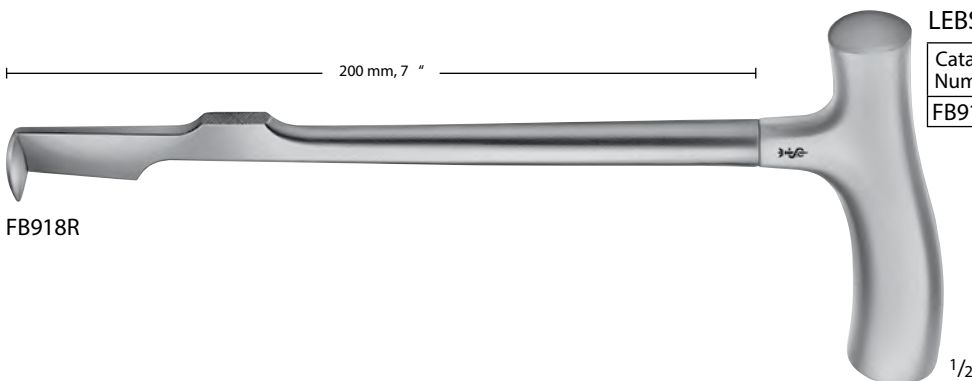

FB918R

LEBSCHE Sternum Chisel

Catalog Number	Length (in.)
FB918R	9 3/4

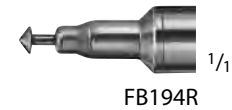
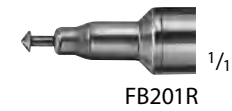
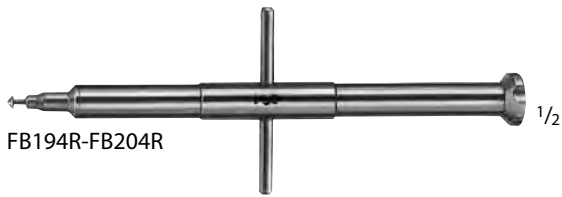

Aorta Punch

Catalog Number	Tip Size (mm)	Length (in.)
FB201R	3.0	5 1/2
FB202R	3.5	5 1/2
FB194R	4.0	5 1/2
FB203R	4.5	5 1/2
FB195R	5.0	5 1/2
FB204R	5.5	5 1/2
FB196R	6.0	5 1/2

Valvulotome

Catalog Number	Tip	Length (in.)
MB360R	ANTEGRADE	6 3/8
MB358R	RETROGRADE	9 1/2
MB359R	RETROGRADE	12 1/4



JENKNER Tunnelling Instruments

Catalog Number	Diameter (mm)	Description	Length (in.)
FC004R	12	TUNNELLING TUBE W/ CONICAL TIP	16
FC005R	12	TUNNELLING TUBE W/ CONICAL TIP	20
FC014R	14	TUNNELLING TUBE W/ CONICAL TIP	16
FC015R	14	TUNNELLING TUBE W/ CONICAL TIP	20
FC034R	5	TUNNELLING FORCEPS F/ FC004R/ FC014R	16
FC035R	5	TUNNELLING FORCEPS F/ FC005R/ FC015R	20
FC030	-	HANDLE F/ TUNNELLING TUBES	-

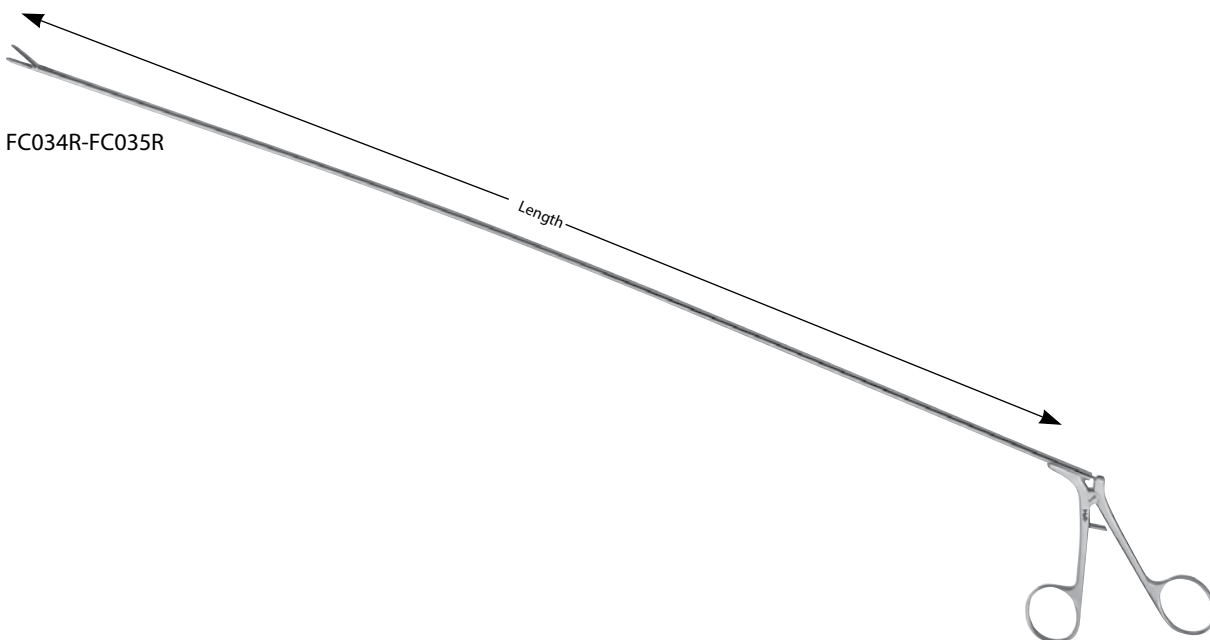
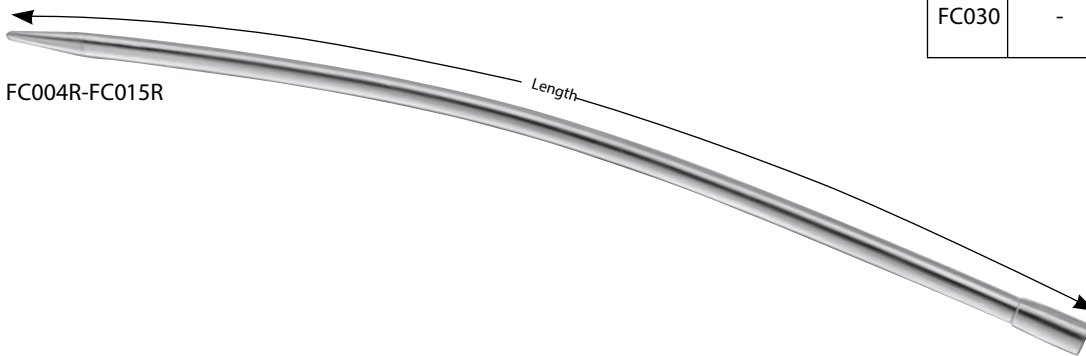

FC030

Let Us know if you could not find what you are looking for

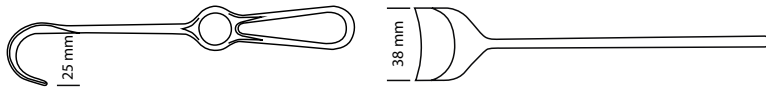

Dimensions for blade size of retractors
 1st number = depth Example: 25 x 38 mm
 2nd number = width



CUSHING Vessel Hook

Catalog Number	Tip Size (mm)	Tip	Length (in.)
BT082R	1 x 4	BLUNT	7 1/2
BT083R	1 x 7	BLUNT	7 1/2
BT084R	1 x 6	BLUNT	11

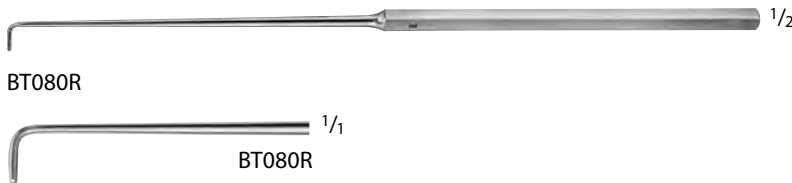

CRILE Vessel Hook

Catalog Number	Tip Size (mm)	Tip	Length (in.)
BT080R	1.5 x 9	BLUNT	7 7/8



DANDY Nerve Hook

Catalog Number	Tip Size (mm)	Tip	Length (in.)
MD562	1 x 8	BLUNT	8 3/4

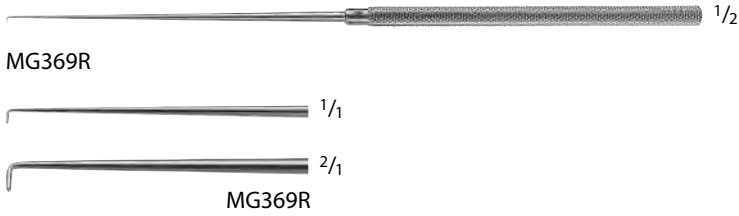

Blunt Hook

Catalog Number	Tip Size (mm)	Tip	Length (in.)
MG369R	2	RND	7

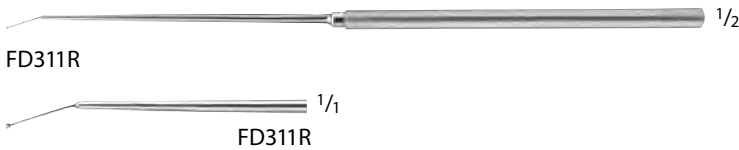

JACOBSON Probe

Catalog Number	Tip	Length (in.)
FD311R	ANG, SINGLE PROBE	7 1/4
FD312R	STR, DOUBLE PROBE	7 1/4

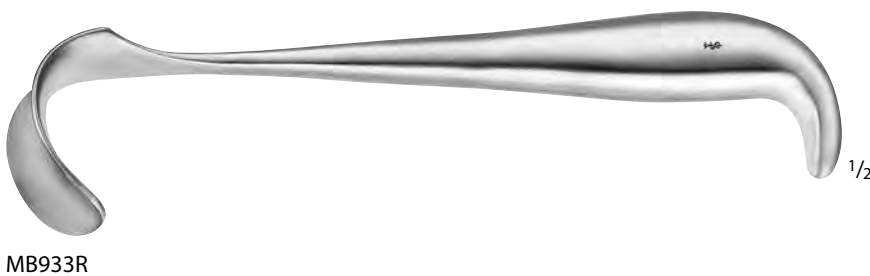
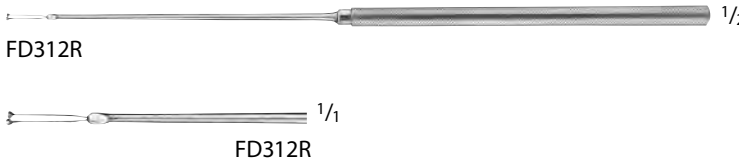

BREWSTER Retractor

Catalog Number	Blade Size (mm)	Blade	Length (in.)
MB933R	25 x 45	CVD CONVEX	9

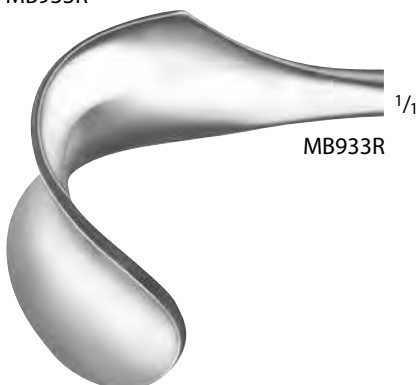

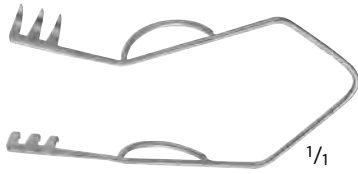

BV014R



BV021R-BV024R

PARSONNET Epicardial Retractors

Catalog Number	Blade End	Tip	Length (in.)
BV014R	3 x 3 PRONGS	SHARP	2

IMA Epicardial Retractor

Catalog Number	Blade End	Tip	Length (in.)
BV021R	3 x 3 PRONGS	SHARP	1
BV022R	3 x 3 PRONGS	SHARP	1 1/4
BV023R	3 x 3 PRONGS	SHARP	1 1/2
BV024R	3 x 3 PRONGS	SHARP	2



MB047R-MB048R, MB700R-MB703R

ROSS Aortic Valve Retractor

Catalog Number	Blade Size (mm)	Length (in.)
MB047R	15 x 15	10
MB048R	13 x 22	10
MB700R	17 x 24	10
MB701R	13 x 27	10
MB702R	30 x 28	10
MB703R	40 x 25	10



MB047R



MB048R



MB700R



MB701R



MB702R



MB703R



FB923R-FB927R

1/2

COOLEY Atrium Retractor, Left

Catalog Number	Blade Size (mm)	Length (in.)
FB923R	25 x 20	9 5/8
FB924R	25 x 25	9 5/8
FB925R	25 x 30	9 5/8
FB926R	25 x 35	9 5/8
FB927R	25 x 45	9 5/8



25 x 20 mm

FB923R

1/1



25 x 25 mm

FB924R

1/1

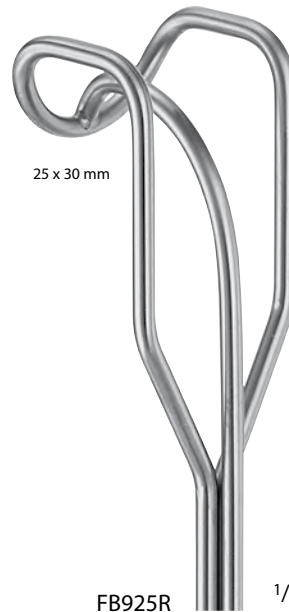

25 x 30 mm

FB925R

1/1

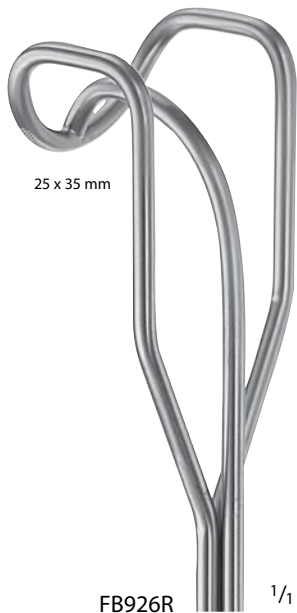

25 x 35 mm

FB926R

1/1

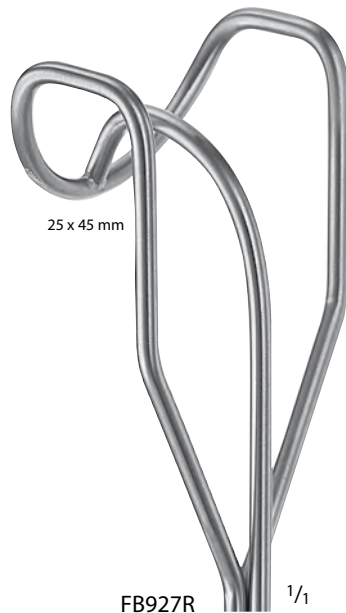

25 x 45 mm

FB927R

1/1



FB963R-FB968R

COOLEY Atrium Retractor, Right

Catalog Number	Blade Size (mm)	Length (in.)
FB963R	25 x 20	9 1/4
FB964R	40 x 25	9 1/4
FB965R	40 x 30	9 1/4
FB966R	40 x 35	9 1/4
FB967R	40 x 45	9 1/4
FB968R	50 x 35	9 1/4



25 x 20 mm

FB963R

1/1



40 x 25 mm

FB964R

1/1

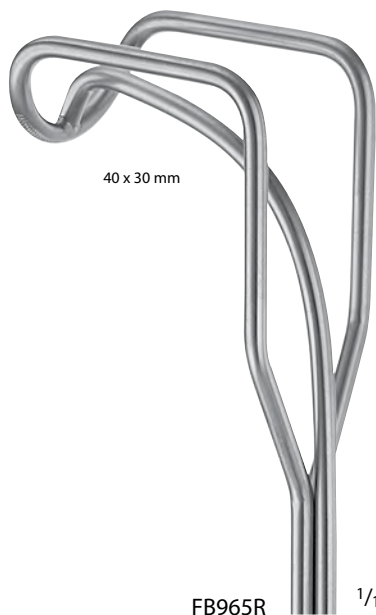

40 x 30 mm

FB965R

1/1

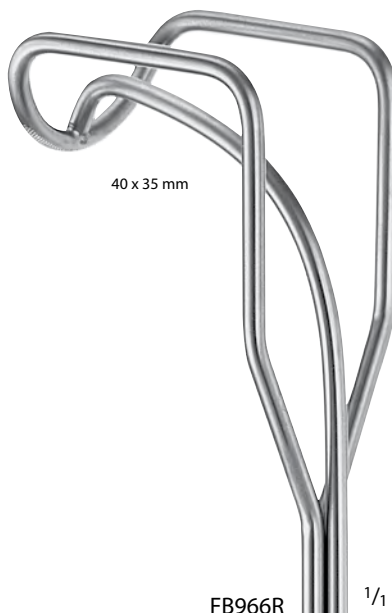

40 x 35 mm

FB966R

1/1

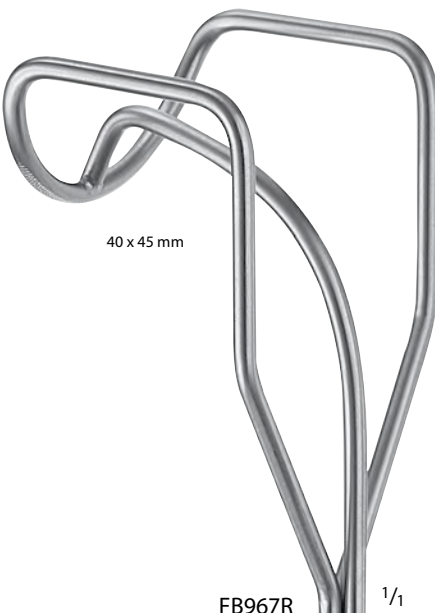

40 x 45 mm

FB967R

1/1

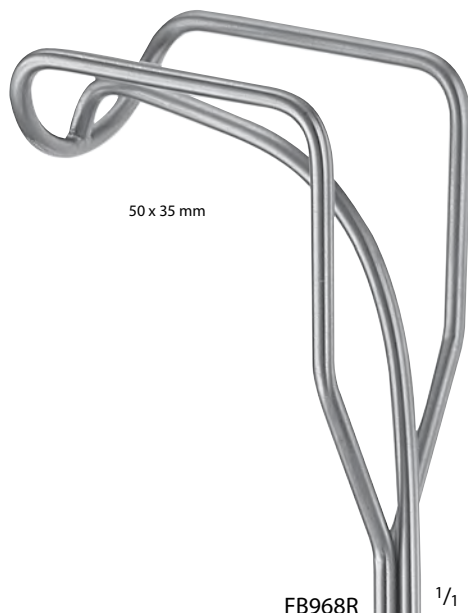

50 x 35 mm

FB968R

1/1

COOLEY Atrial Retractor, Right

Catalog Number	Blade Size (mm)	Length (in.)
MB383R	22 x 19	9 1/4
MB385R	29 x 19	9 1/4
MB386R	38 x 38	9 1/4
MB387R	48 x 44	9 1/4



MB383R-MB387R

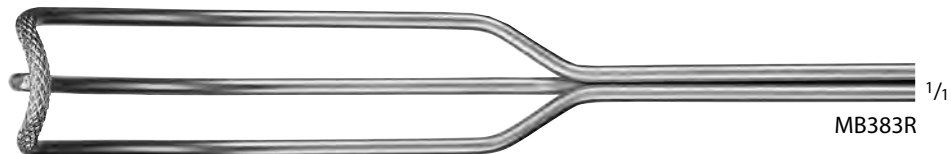

MB383R

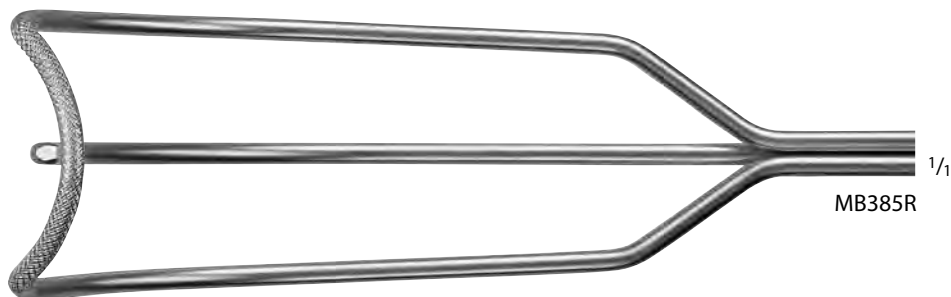

MB385R

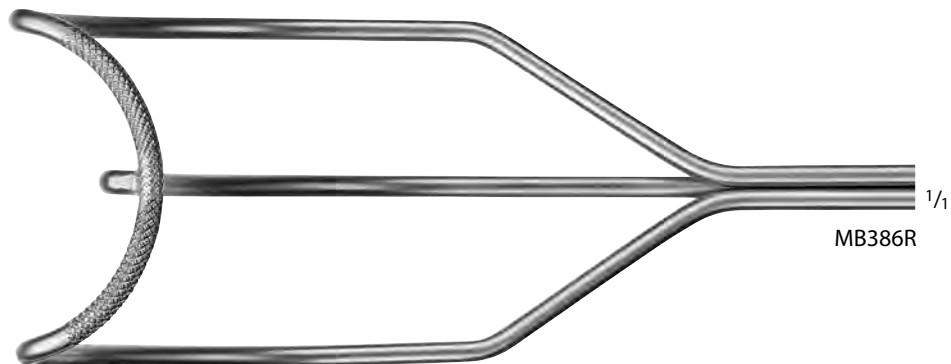

MB386R

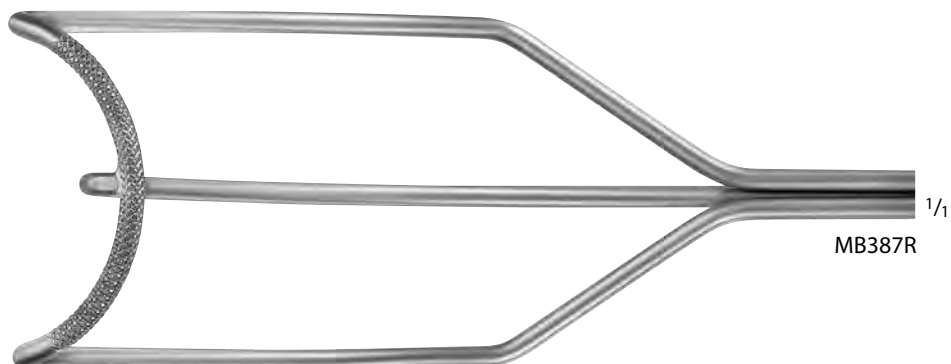

MB387R

Let Us know if you could not find what you are looking for



MB356R-MB357R

COOLEY Atrial Retractor, Left

Catalog Number	Blade Size (mm)	Length (in.)
MB356R	19 x 38	9 1/4
MB357R	19 x 44	9 1/4

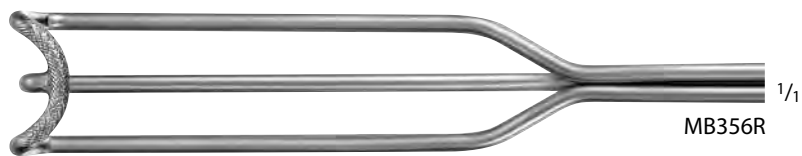

MB356R

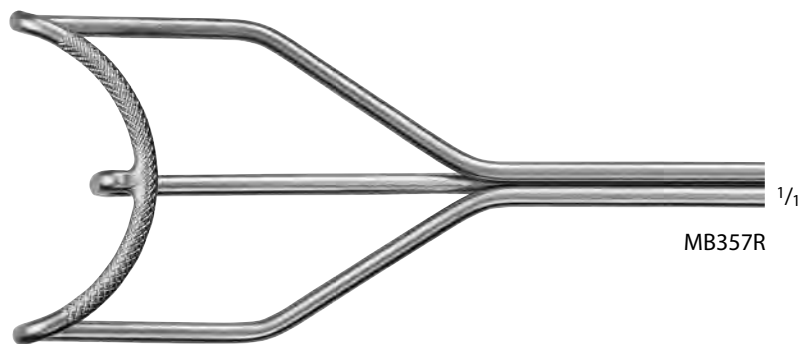

MB357R

KRASKY Retractor

Catalog Number	Blade End	Tip	Blade Size (mm)	Length (in.)
MG067R	6 PRONGS	SHARP	51 x 25	11



MG067R

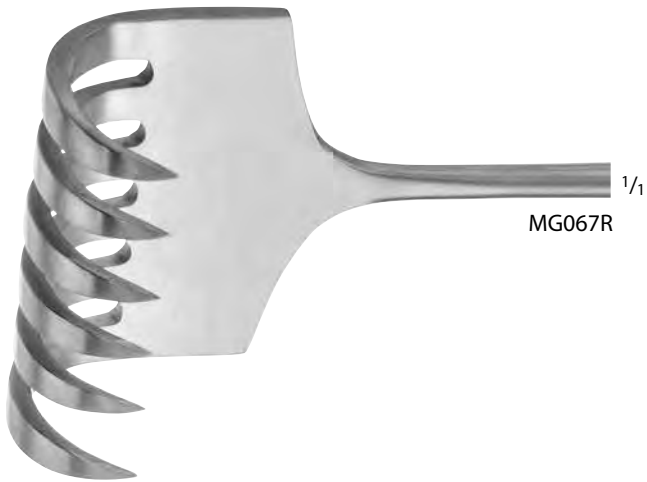

MG067R

CORYLLOS Retractor

Catalog Number	Blade Size (mm)	Length (in.)
BT521R	80 x 20	10
BT522R	115 x 38	10
BT523R	115 x 65	10

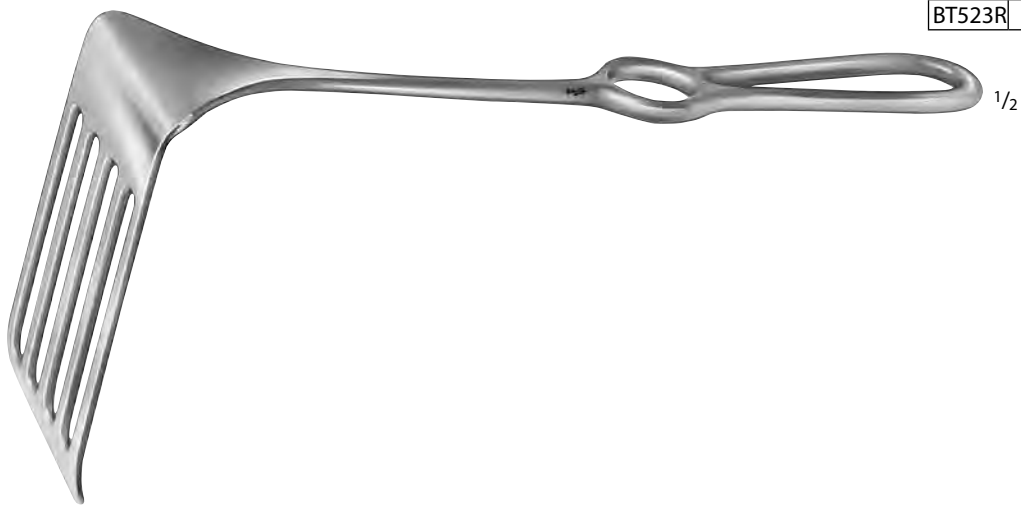

BT521R-BT523R

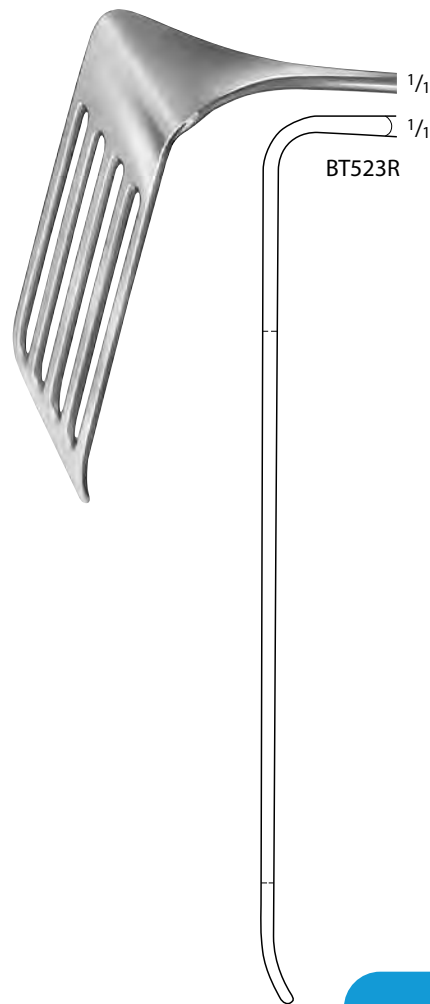
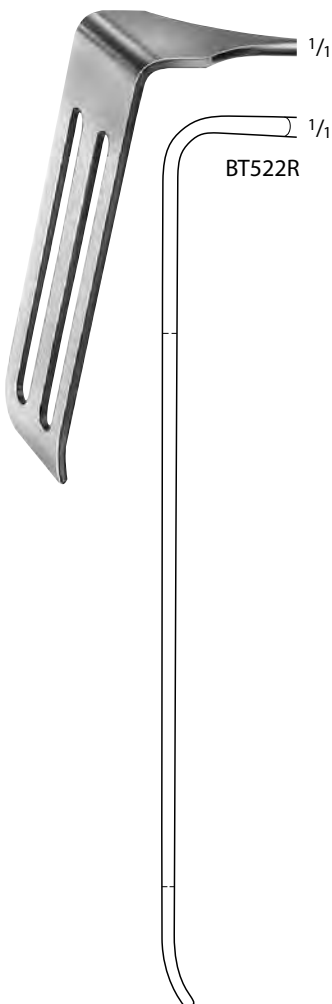
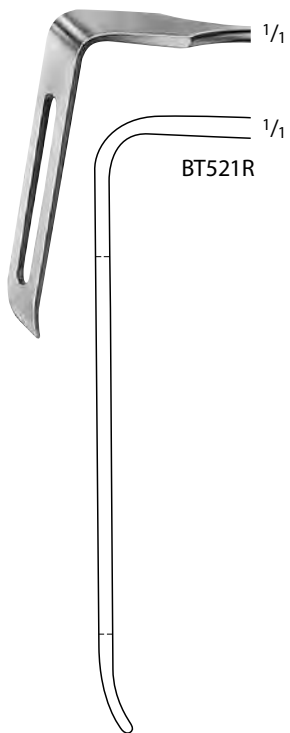

DAVIDSON Scapula Retractor

Catalog Number	Blade Size (mm)	Length (in.)
MB758R	80 x 50	7 3/4
BT531R	90 x 80	7 3/4

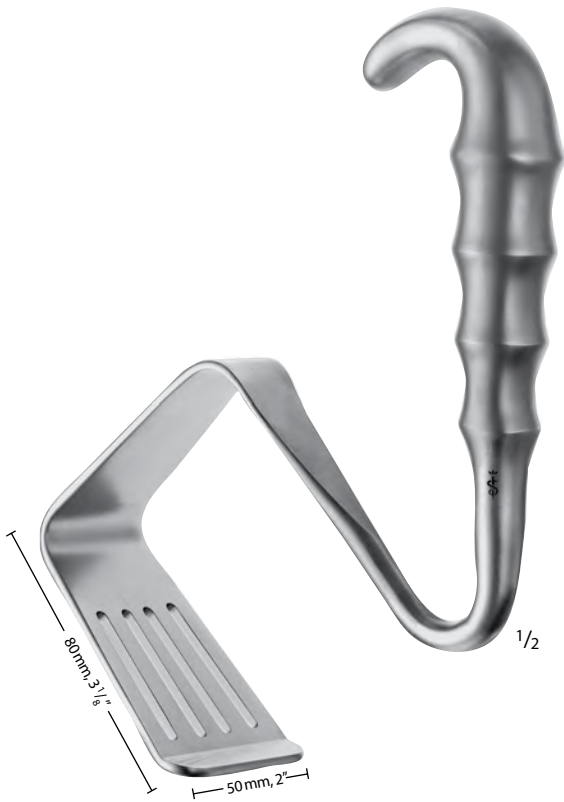

MB758R

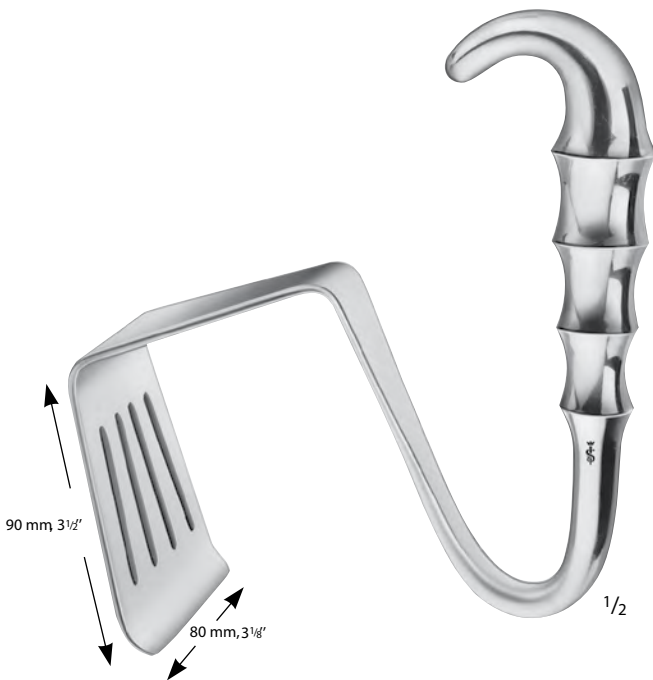

BT531R



MB971R-MB972R

SEMBA Lung Retractor

Catalog Number	Blade Size (mm)	Length (in.)
MB971R	29 x 19	9 1/4
MB972R	41 x 25	9 1/4



BT559R

ALLISON Lung Spatula

Catalog Number	Blade Size (mm)	Length (in.)
BT559R	40	10
BT560R	54	12 1/2

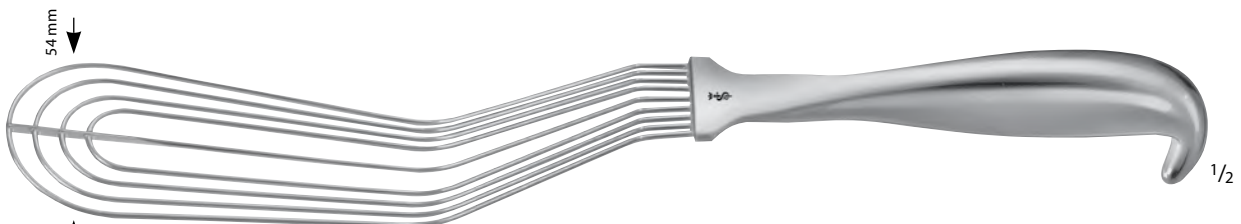

BT560R

ALLISON "Sweetheart" Lung Spatula

Catalog Number	Blade Size (mm)	Length (in.)
BT561R	137	11 3/4

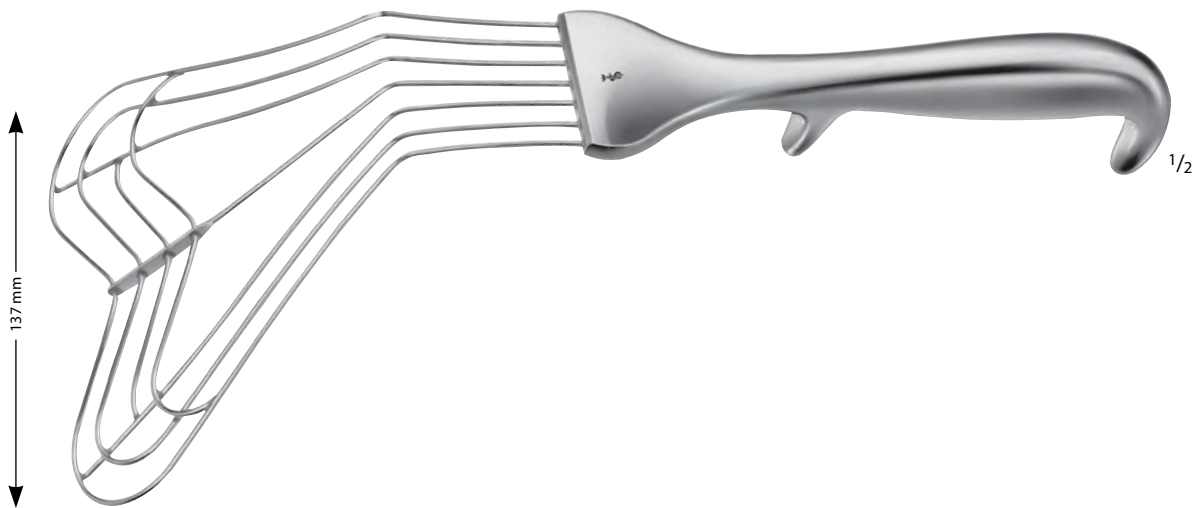

BT561R

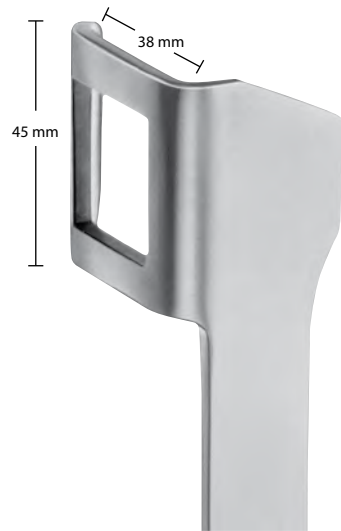

Dimensions for blade size of rib spreaders:
 1st number = Depth
 2nd number = Width
 Example: 38 x 45 mm

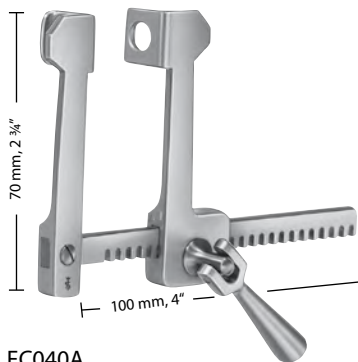

FC040A

FINOCHIETTO Rib Spreader, Aluminum

Catalog Number	Blade Size (mm)
FC040A	12 x 15

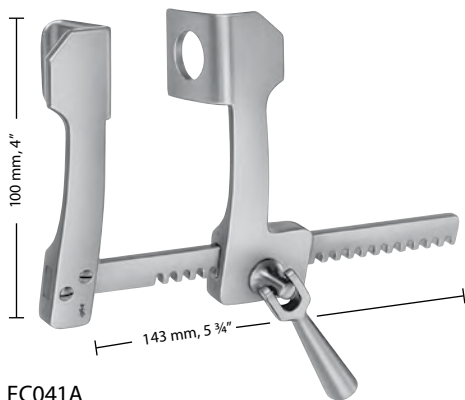

FC041A

FINOCHIETTO-HAIGHT Rib Spreader, Aluminum

Catalog Number	Blade Size (mm)
FC041A	28 x 30

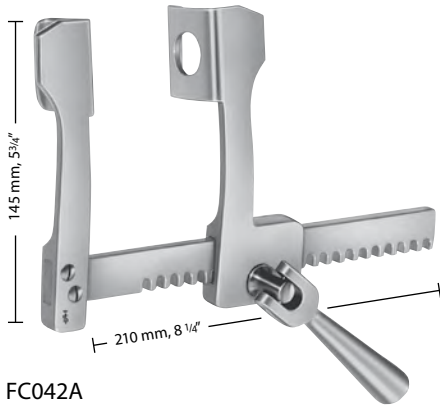

FC042A

FINOCHIETTO Rib Spreader, Aluminum

Catalog Number	Blade Size (mm)
FC042A	31 x 45

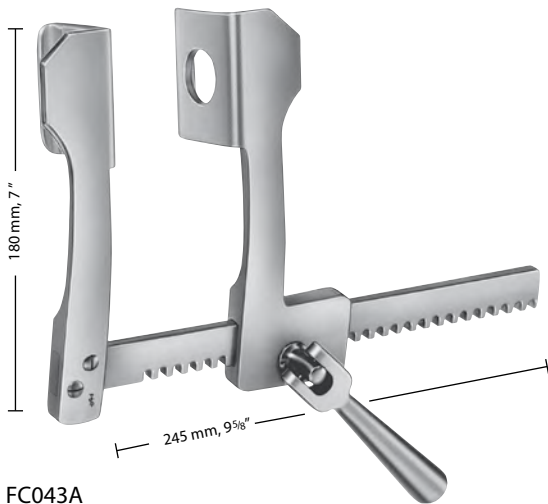

FC043A

FINOCHIETTO Rib Spreader, Aluminum

Catalog Number	Blade Size (mm)
FC043A	42 x 61

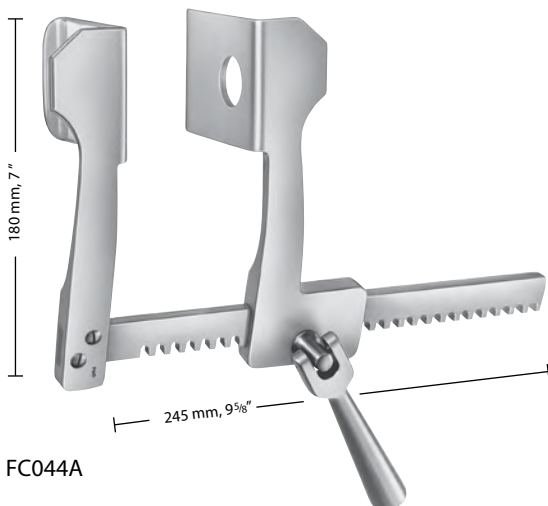

FC044A

FINOCHIETTO Rib Spreader, Aluminum

Catalog Number	Blade Size (mm)
FC044A	74 x 64

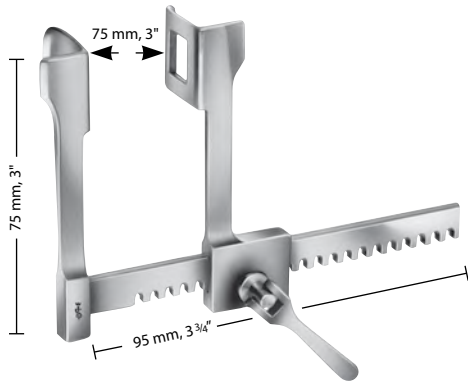

FB830R

FINOCHIETTO Rib Spreader, Infant

Catalog Number	Blade Size (mm)
FB830R	18 x 21

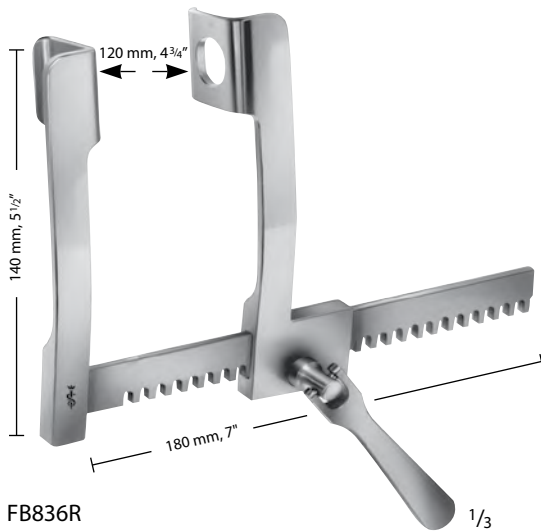

FB836R

FINOCHIETTO Rib Spreader, Pediatric

Catalog Number	Blade Size (mm)
FB836R	28 x 32

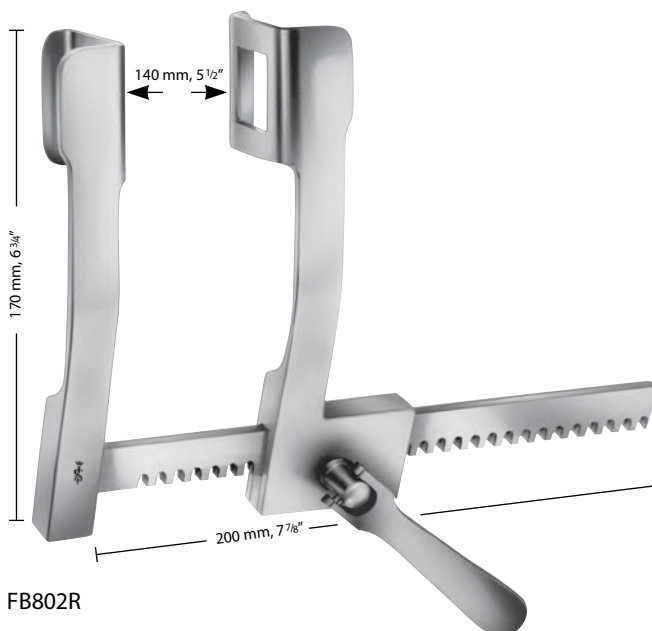

FB802R

FINOCHIETTO Rib Spreader, Small Adult

Catalog Number	Blade Size (mm)
FB802R	36 x 45

FINOCHIETTO Rib Spreader, Adult

Catalog Number	Blade Size (mm)
FB803R	44 x 65
FB804R	65 x 65

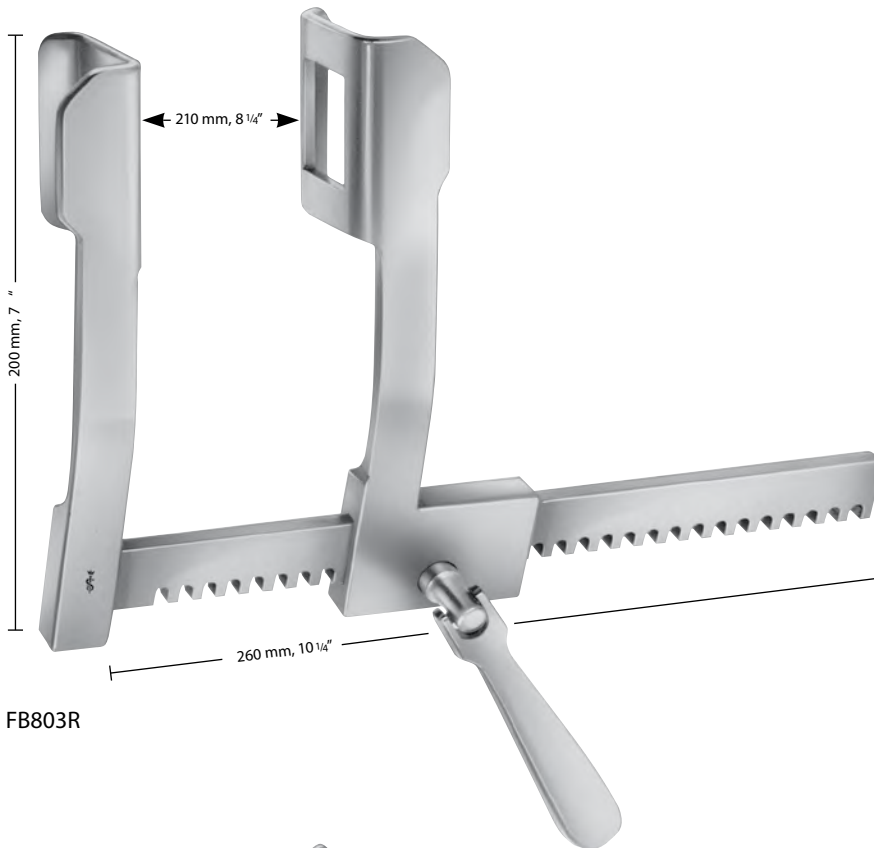

FB803R

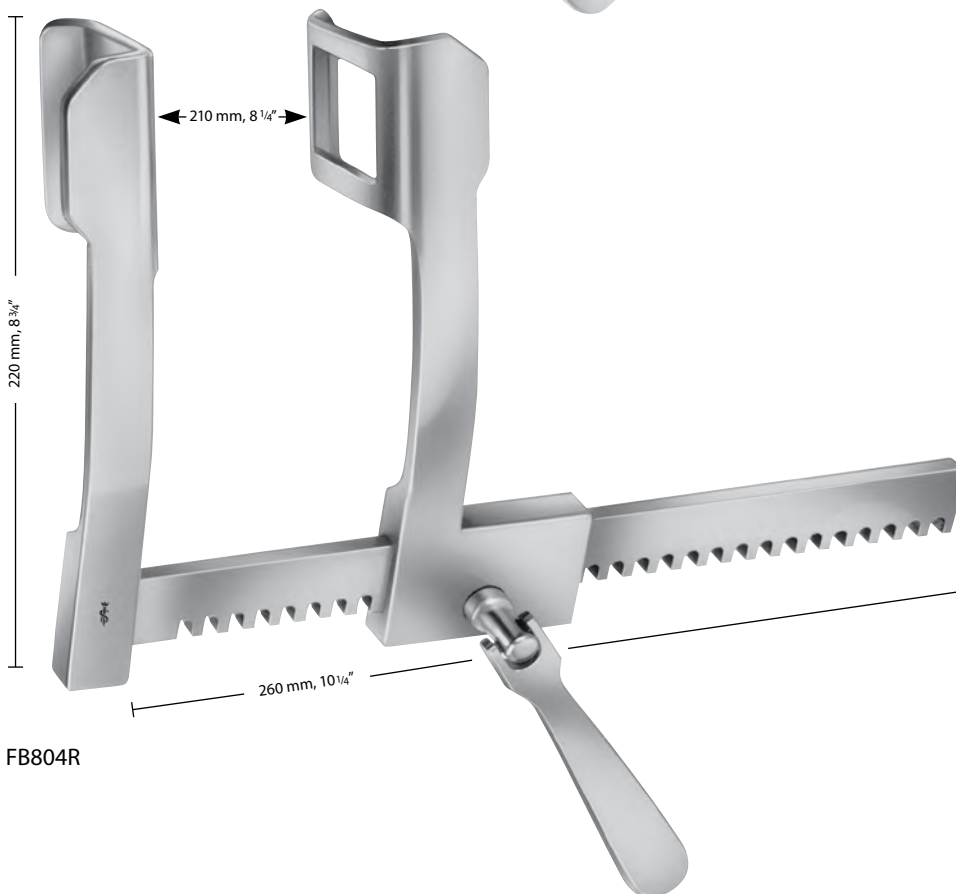

FB804R

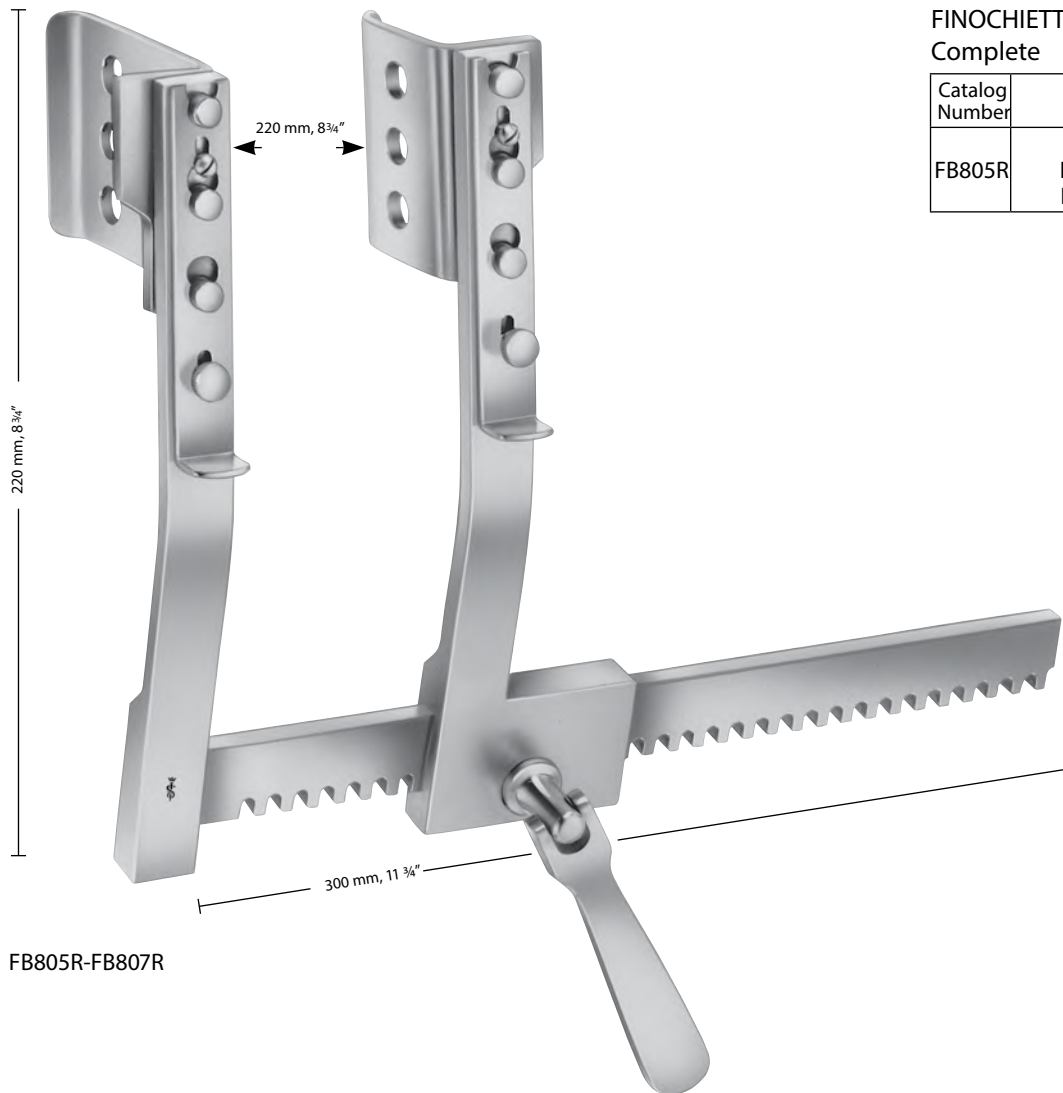

FB805R-FB807R

FINOCHIETTO-BURFORD Rib Spreader, Complete

Catalog Number	Description
FB805R	COMPLETE,W/ BLADES FB806R (45 MM x 64 MM) FB807R (75 MM x 64 MM)

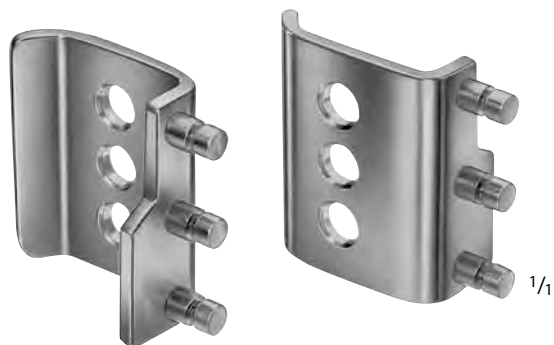

FB806R



FB807R

HAIGHT Rib Spreader

Catalog Number	Blade Size (mm)
FB835R	30 x 30

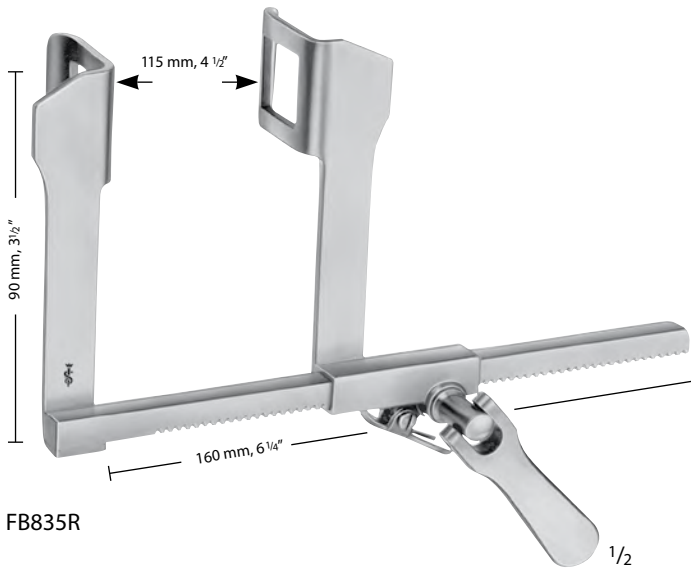

Rib Spreader, Premie

Catalog Number	Blade Size (mm)	Description
MG062R	7 x 7	SPREAD 1 1/2", ARM LENGTH 1 1/2"

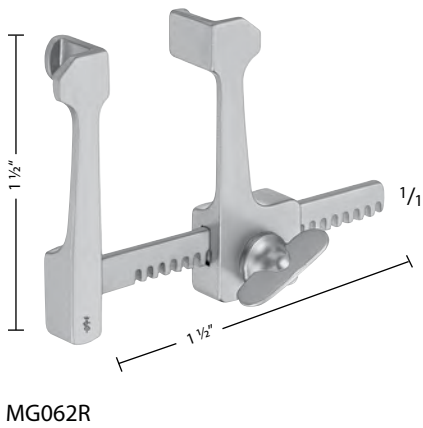

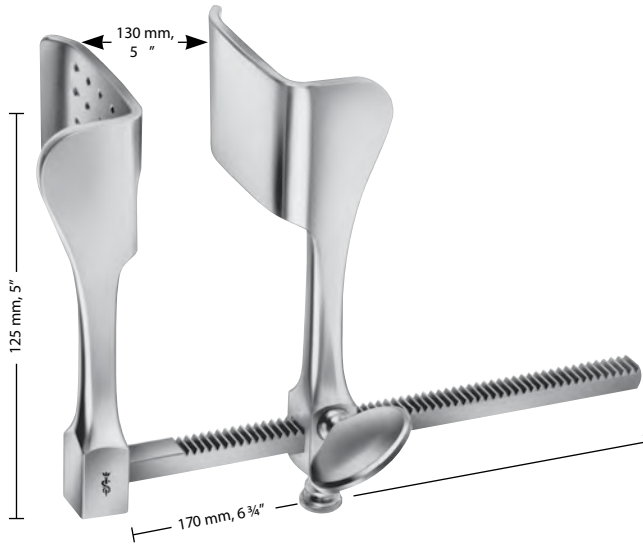

FB800R

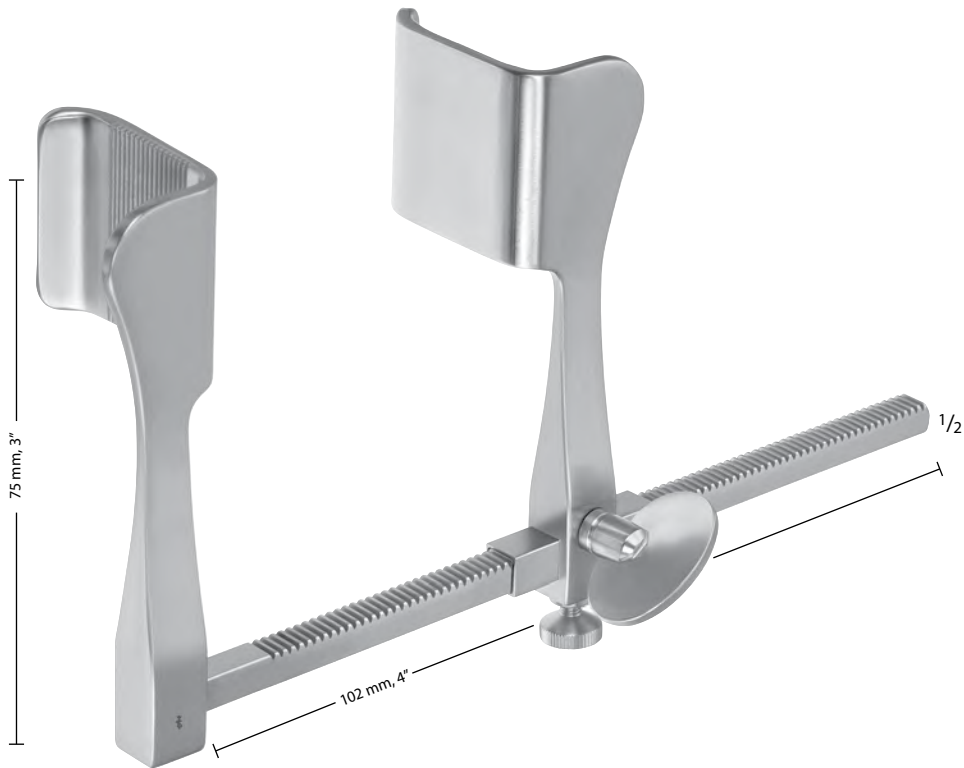

MG061R

TUFFIER Rib Spreader

Catalog Number	Blade Size (mm)	Blade End
FB800R	43 x 53	RIBBED
MG061R	45 x 47	SERR



FB844R

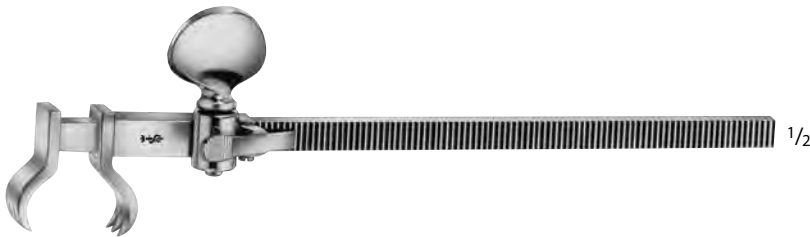
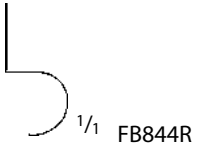

FB841R-FB842R



FB841R



FB841R



FB842R

BAILEY Rib Contractor

Catalog Number	Description	Length (in.)
FB844R	PEDIATRIC	6
FB841R	SMALL ADULT	7 7/8
FB842R	ADULT	7 7/8



MG015R

FAVALORO-MORSE Sternal Retractor

Catalog Number	Blade Size (mm)
MG015R	40 x 29

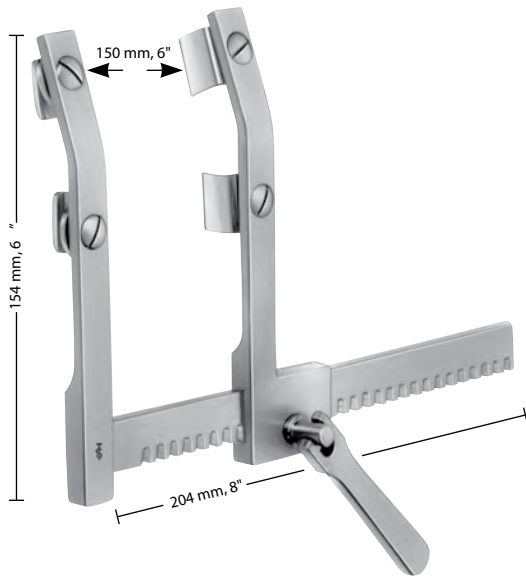

FB845R

MORSE Sternotomy Retractor, Pediatric

Catalog Number	Blade Size (mm)
FB845R	12 x 20

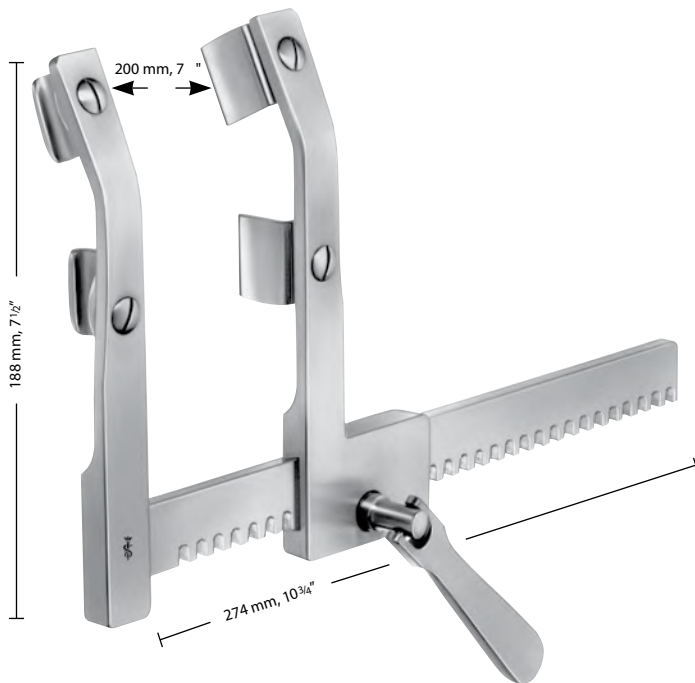

FB846R

MORSE Sternotomy Retractor, Adult

Catalog Number	Blade Size (mm)
FB846R	19 x 29

REINHOFF Rib Spreader

Catalog Number	Blade Size (mm)
MG063R	45 x 50

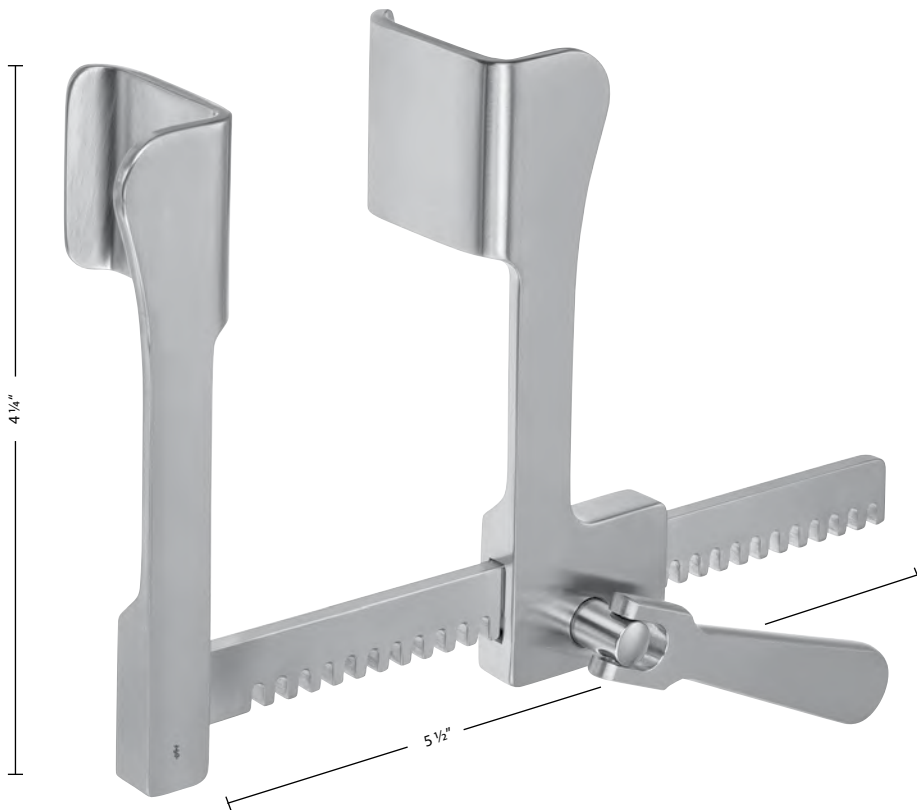

MG063R

COOLEY Sternotomy Spreader, Pediatric

Catalog Number	Blade Size (mm)
FB851R	21 x 45

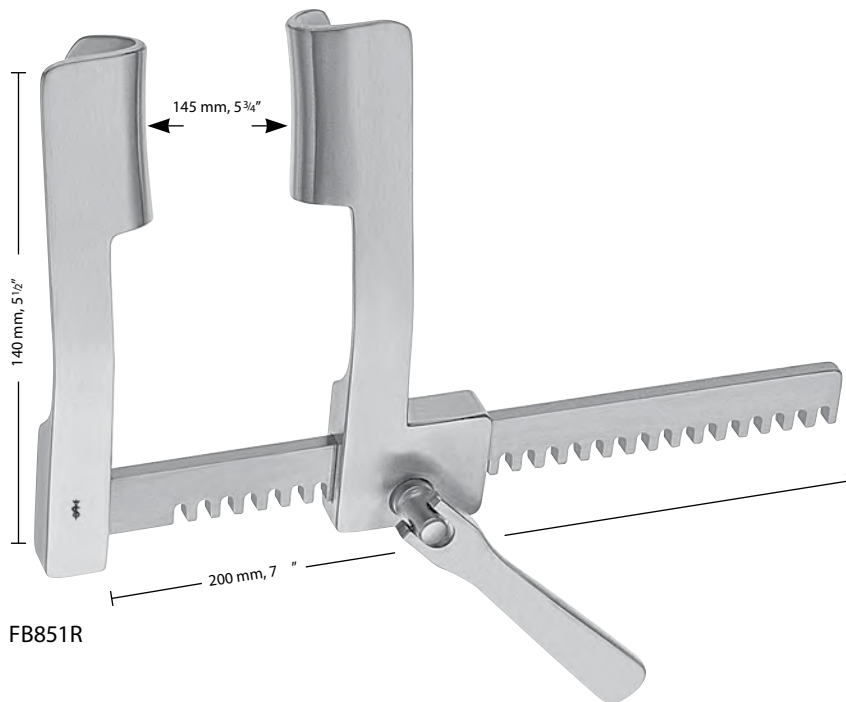

COOLEY Sternotomy Spreader, Adult

Catalog Number	Blade Size (mm)
FB850R	32 x 50

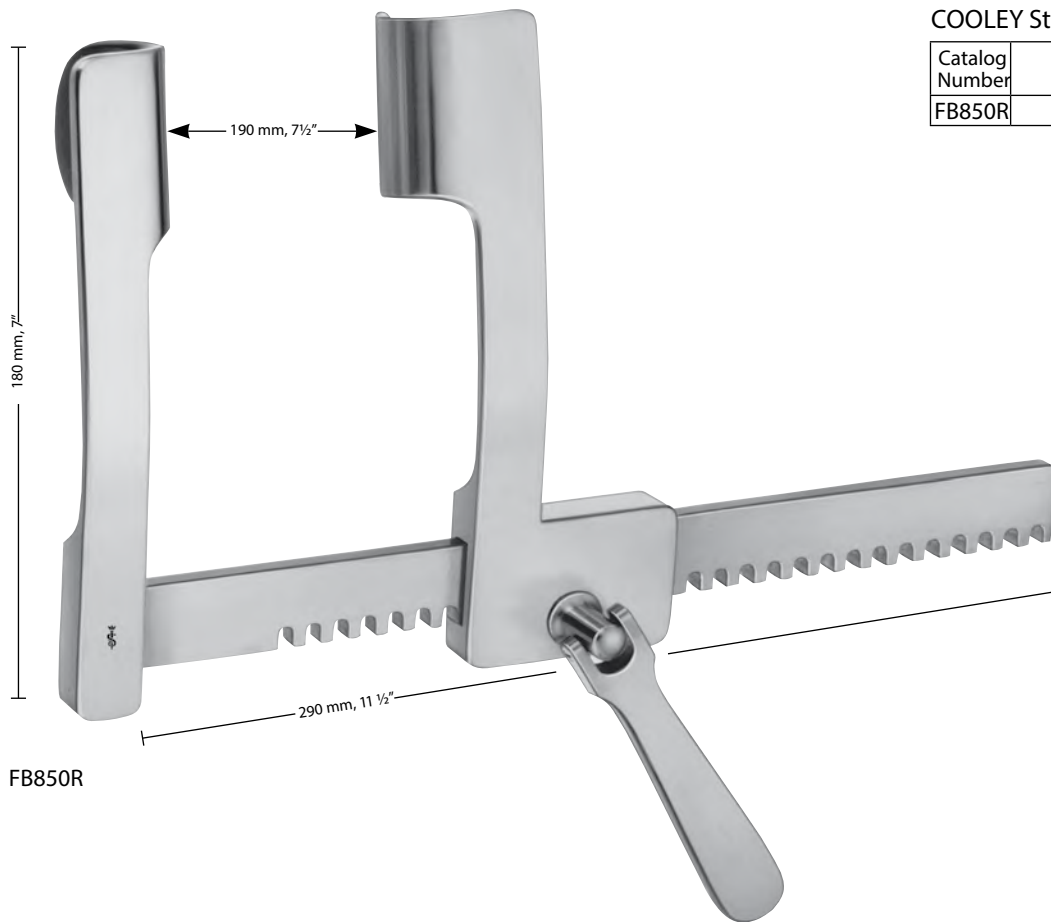

FB850R



FB850R

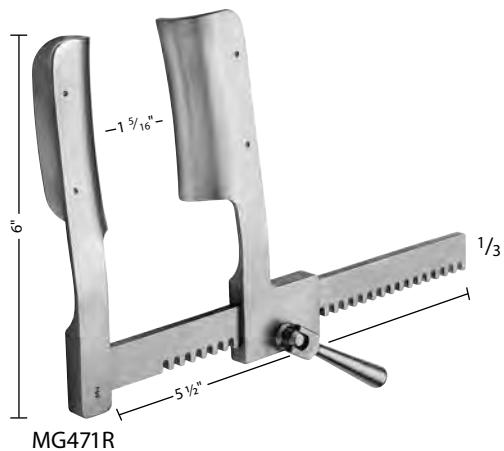

COOLEY Sternotomy Spreader, Extra Large

Catalog Number	Blade Size (mm)
MG471R	35 x 100

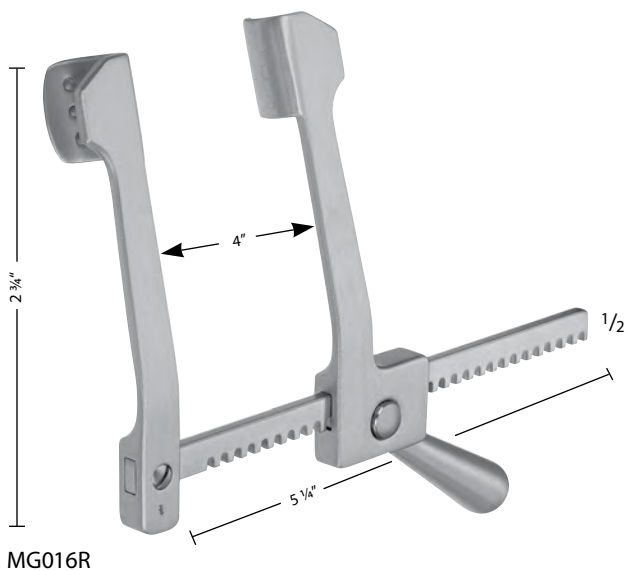

COOLEY Sternal Retractor, Aluminum, Pediatric

Catalog Number	Blade Size (mm)
MG016R	17 x 19 W/ PINS

Sternal Retractor

Catalog Number	Blade Size (mm)	Description
MG017R	12 x 10	DOUBLE BLADES 12 x 10 MM
MG018R	14 x 14	DOUBLE BLADE 14 x 14 MM
MG019R	20 x 19	DOUBLE BLADE 20 x 19 MM

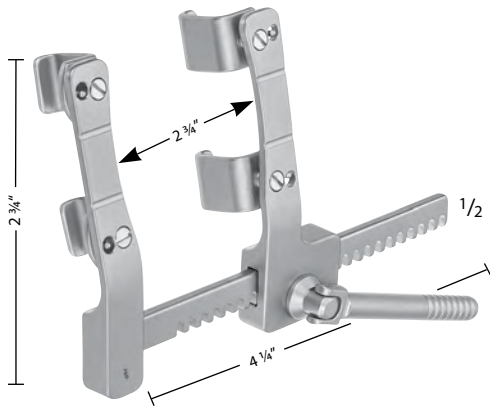

MG017R

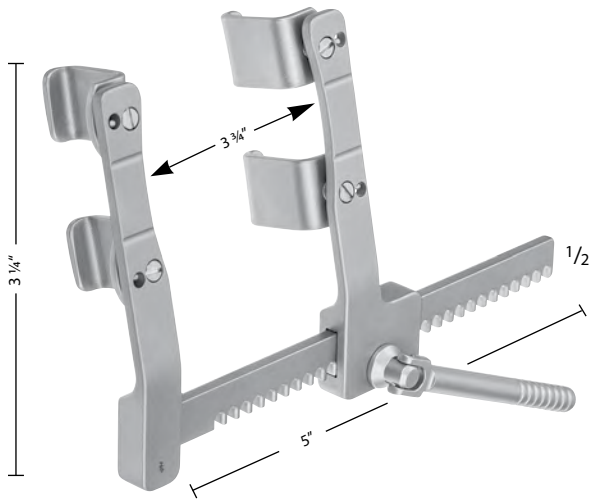

MG018R

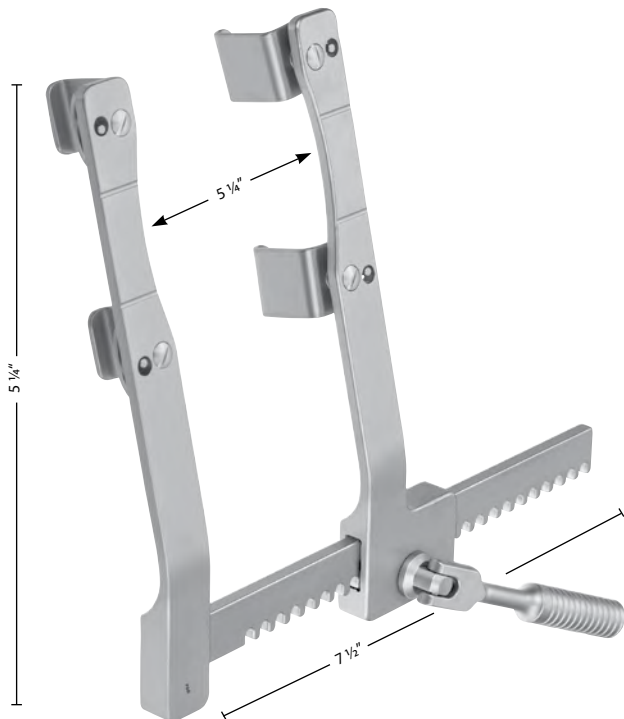

MG019R

CHAUX Sternal Retractor

Catalog Number	Blade Size (mm)	Description
MG020R	27 x 30	ROTATION FOR IMA EXPOSURE

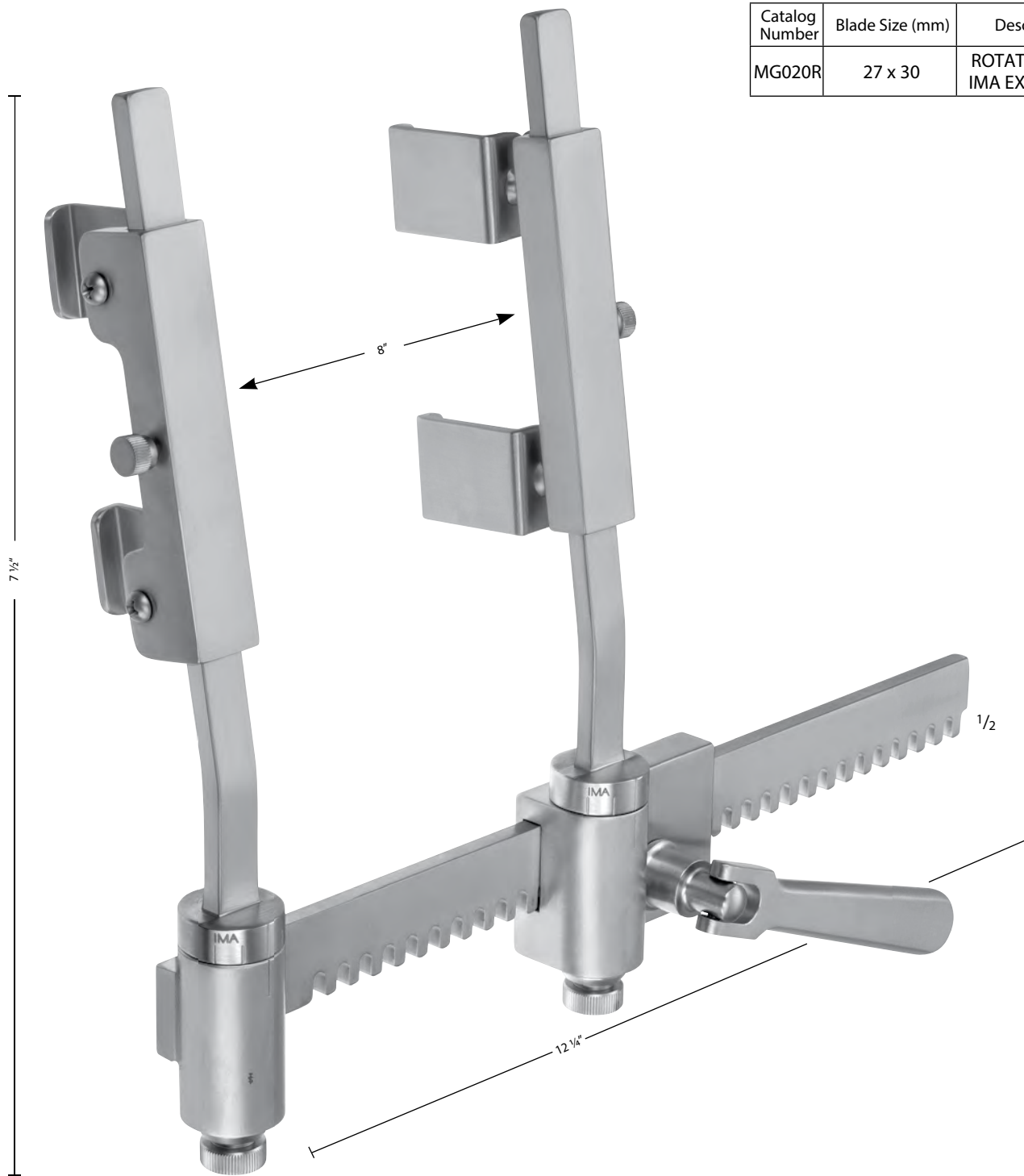

MG020R

Let Us know if you could not find what you are looking for

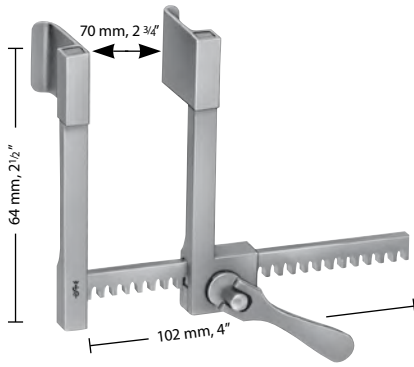

FB852R



STRUCK Rib Spreader, Infant

Catalog Number	Description
FB852R	COMPLETE
FB853R	SPREADER ONLY, 64 x 92 MM
FB854R	OPT. BLADES, 10 x 10 MM, 2/SET
FB855R	OPT. BLADES, 10 x 15 MM, 2/SET
FB856R	OPT. BLADES, 10 x 20 MM, 2/SET
FB857R	BLADES, 15 x 20 MM, 2/SET
FB858R	BLADES, 20 x 20 MM, 2/SET

FB852R Includes:
 FB853R Spreader only
 FB857R Blades (pair)
 FB858R Blades (pair)



ENT-EAR

Scissors	536
Needles	537 - 538
Tissue, Dressing and Sponge Forceps	539 - 542
Alligator Forceps	543 - 549
Nippers, Crimping Forceps and Snares	550 - 553
Hooks and Probes	554 - 555
Retractors	556 - 557
Picks	558 - 561
Specula	562 - 567
Cotton Applicators	568
Knives	569 - 575
Suction Irrigation	576 - 579
Dissectors, Chisels and Gouges	580 - 581
Elevators, Scrapers and Excavators	582 - 583
Augers, Measurers and Rasps	584
Curettes, Loops and Spoons	585 - 589
Rongeurs	590
Tuning Forks	591
Miscellaneous	592 - 593

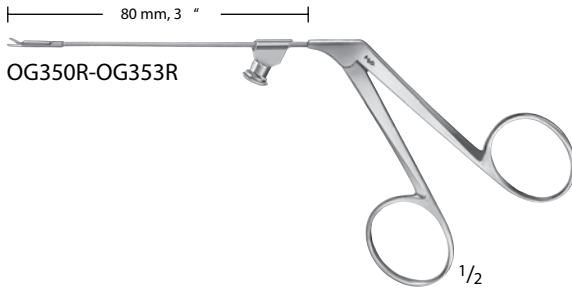

BELLUCCI Micro Scissors

Catalog Number	Tip	Blade	Working Length (in.)	Length (in.)
OG350R	S/S	STR	3 1/8	5 1/4
OG352R	S/S	CVD-LEFT	3 1/8	5 1/4
OG353R	S/S	CVD-RIGHT	3 1/8	5 1/4
OG351R	B/B	ANG-UP	3 1/8	5 1/4

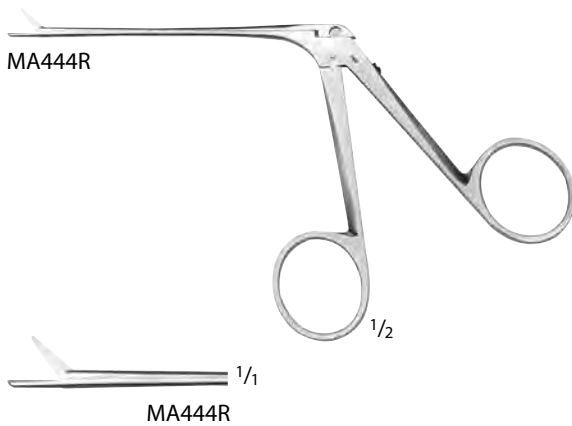
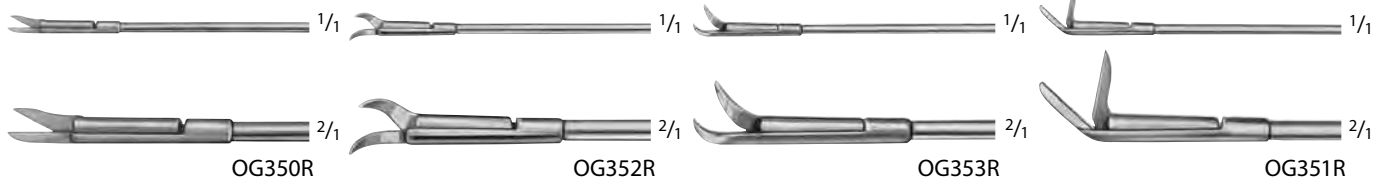

BELLUCCI Scissors

Catalog Number	Tip	Blade	Blade Size (mm)	Working Length (in.)	Length (in.)
MA444R	B/B	STR	7	3	5 1/4
OG355R	S/S	CVD-UP	-	3 1/8	5 1/4

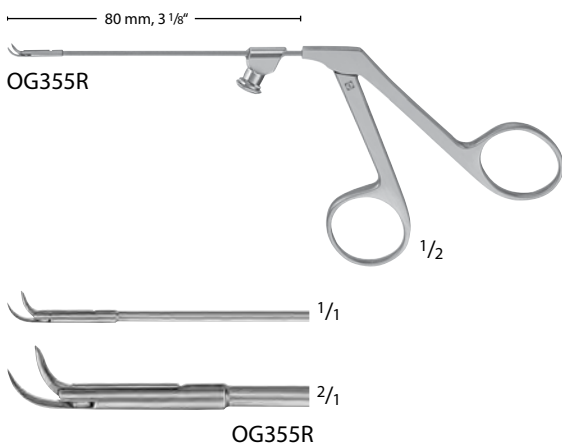

WIET Ear Scissors, Bayonet-Shaped

Catalog Number	Tip	Blade	Length (in.)
MB049R	S/S	STR	6 1/2

Let Us know if you could not find what you are looking for

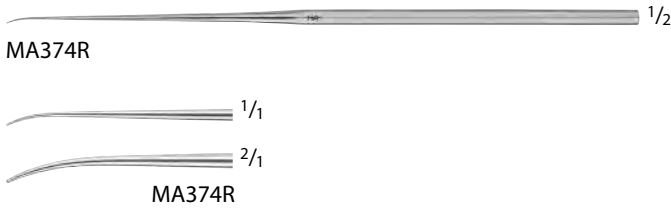

HOUSE Needle

Catalog Number	Tip	Blade Shape	Length (in.)
MA374R	DEL	CVD	6 1/2

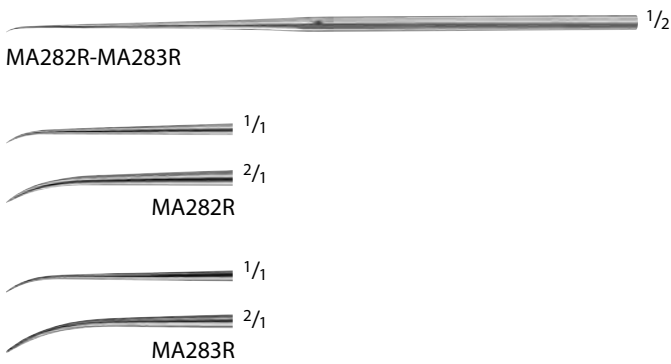

HOUSE Needle, Malleable

Catalog Number	Tip	Blade Angle	Length (in.)
MA282R	SEMI-SHARP	CVD	6 1/2
MA283R	W/ ROSEN POINT, SEMI-SHARP	CVD	6 1/2

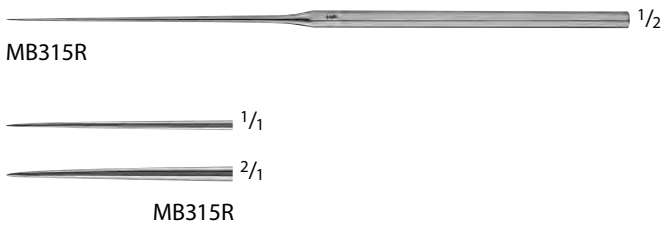

HOUSE-BARBARA Needle

Catalog Number	Tip	Blade Angle	Length (in.)
MB315R	SHARP	STR	6 1/2

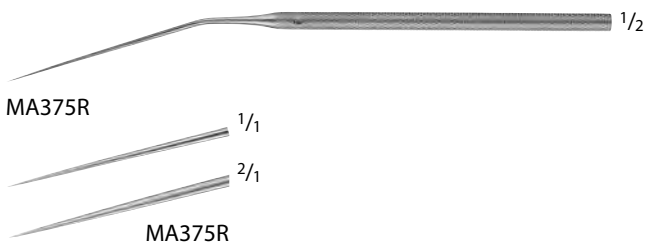

MCGEE Perforating Needle

Catalog Number	Tip	Blade Angle	Length (in.)
MA375R	SHARP	ANG 20°	6 3/8



MA378R



Micro Needles

Catalog Number	Tip	Blade Angle	Length (in.)
OG001R	SHARP-POINT	STR	6 1/4
OG002R	SHARP-POINT	CVD	6 1/4
OG003R	SHARP-POINT	HEAVY-CVD	6 1/4

PAPARELLA Needle, Malleable, Heavy

Catalog Number	Tip Size (#)	Blade Angle	Working Length (in.)	Length (in.)
MA376R	6	STR	2 3/4	6 1/2

SAUNDERS-PAPARELLA Needle, Malleable, Fine

Catalog Number	Tip Size (#)	Blade Angle	Working Length (in.)	Length (in.)
MA377R	5	STR	2 3/4	6 1/2

WRIGHT Fascia Needle

Catalog Number	Tip	Tip Size (mm)	Length (in.)
MA378R	CVD	2	5 1/8



MA550R



MA550R



MA703R

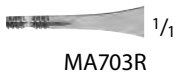

MA703R



OF405R



OF405R



OF403R



OF403R

SHEEHY Ossicle Holding Forceps

Catalog Number	Length (in.)
MA550R	4 3/4

DERLACKI Ossicle Holding Forceps

Catalog Number	Tip	Length (in.)
MA703R	1 MM TEETH W/ VERTICAL AND HORIZONTAL GROOVE	5

HARTMANN Tampon Forceps

Catalog Number	Tip	Length (in.)
OF405R	HEAVY	5
OF403R	DELICATE	5 1/4



OF407R



OF407R

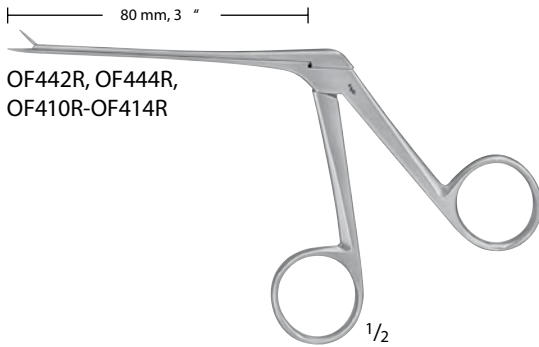

OF442R, OF444R,
 OF410R-OF414R



OF442R



OF444R

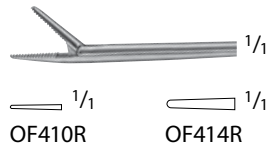

OF410R

OF414R

TILLEY Ear Tampon Forceps

Catalog Number	Tip	Length (in.)
OF407R	X-DEL	5 1/2

HARTMANN-WULLSTEIN Ear Forceps

Catalog Number	Tip Size (mm)	Jaw	Working Length (in.)
OF442R	1	STR, CUP	3 1/8
OF444R	2	STR, CUP	3 1/8
OF410R	0.5 x 6	STR, SERR	3 1/8
OF414R	1 x 8	STR, SERR	3 1/8

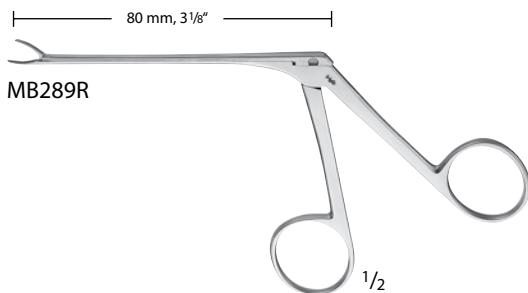

MB289R



MB289R

WEINGARTNER Ear Forceps

Catalog Number	Jaw	Working Length (in.)
MB289R	SERR	3 1/8

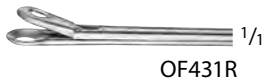
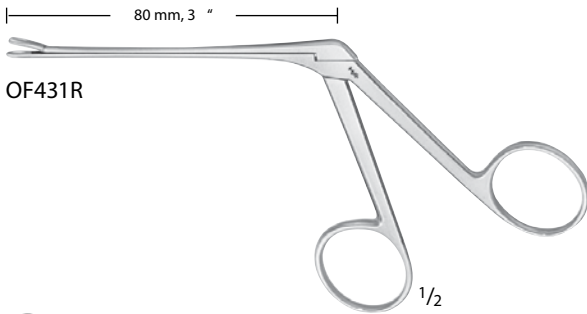

MA549R

QUIRE Foreign Body Forceps

Catalog Number	Working Length (in.)	Length (in.)
OF300R	3 1/2	4 3/4

BUCK Alligator Forceps

Catalog Number	Working Length (in.)	Length (in.)
OF303R	1 7/8	3 1/2

HENCKEL Spoon Forceps

Catalog Number	Tip Size (mm)	Jaw	Working Length (in.)
OF431R	3 x 5	FLAT, OVAL SPOON	3 1/8

LEIVERS Vent Tube Introducer Forceps

Catalog Number	Working Length (in.)	Length (in.)
MA549R	2 7/8	5 3/8

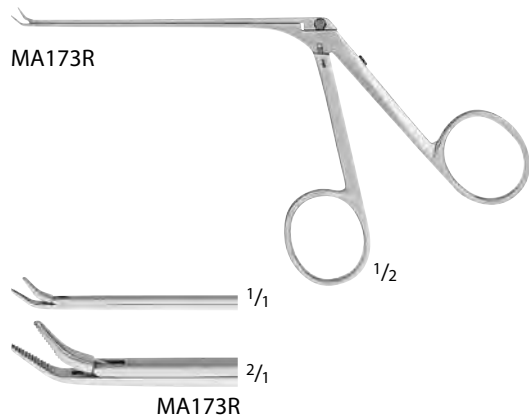
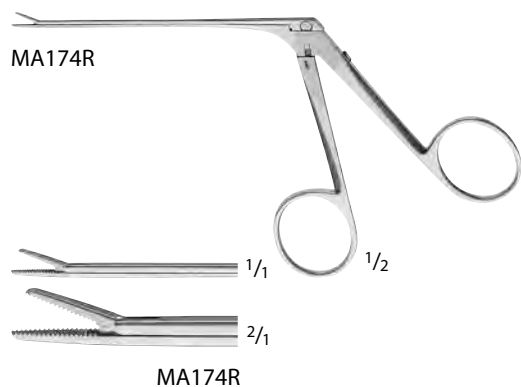
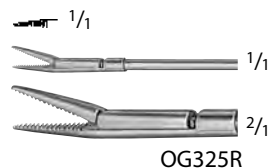
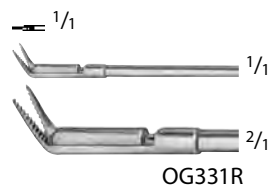
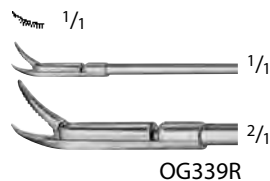
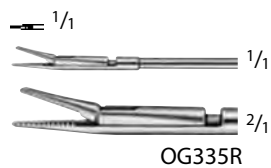
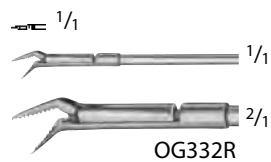
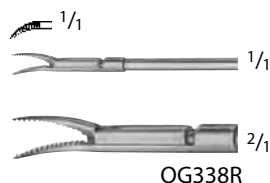
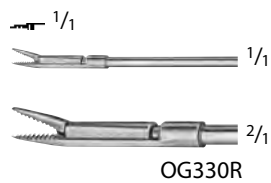
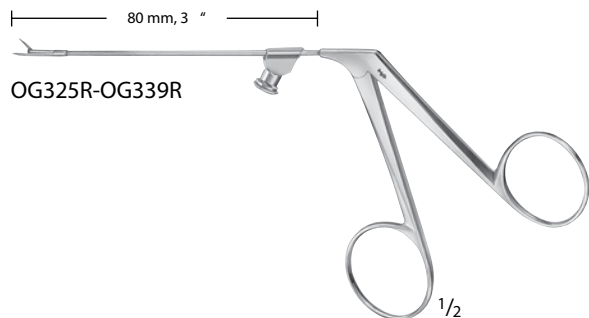

Alligator Forceps, Serrated

Catalog Number	Tip Size (mm)	Jaw	Working Length (in.)
OG330R	0.8 x 3.5	STR	3 1/8
OG335R	1 x 5	STR	3 1/8
OG325R	1.5 x 6.0	STR	3 1/8
MA174R	4	STR	3 1/8
OG338R	1 x 5	CVD-LEFT	3 1/8
OG339R	1 x 5	CVD-RIGHT	3 1/8
OG332R	0.8 x 3.5	ANG-DOWN 45°	3 1/8
OG331R	0.8 x 3.5	ANG-UP 55°	3 1/8
MA173R	4	ANG-UP	3

Let Us know if you could not find what you are looking for

BELLUCCI Alligator Ear Forceps

Catalog Number	Tip Size (mm)	Jaw	Working Length (in.)
MA159R	8	STR, SERR	3 1/4



Alligator Ear Forceps, Ebony

Catalog Number	Tip Size (mm)	Jaw	Working Length (in.)
MA659R	0.8 x 4.5	STR, SERR	3

HARTMANN Ear Forceps

Catalog Number	Tip Size (mm)	Jaw	Working Length (in.)
OF411R	1 x 8	STR, SERR	3 1/8
OF420R	1 x 8	STR, 1 x 2 TEETH	3 1/8

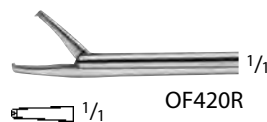
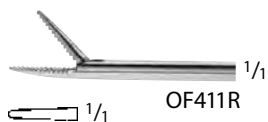
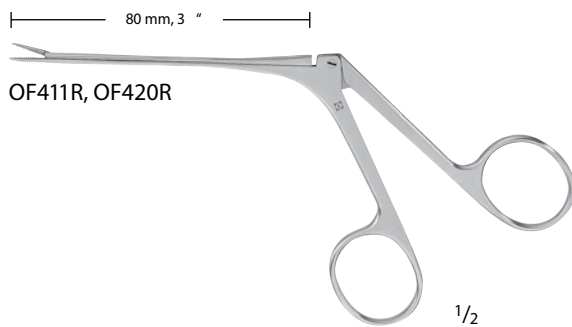

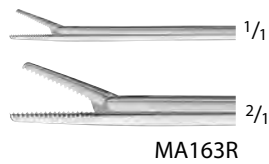
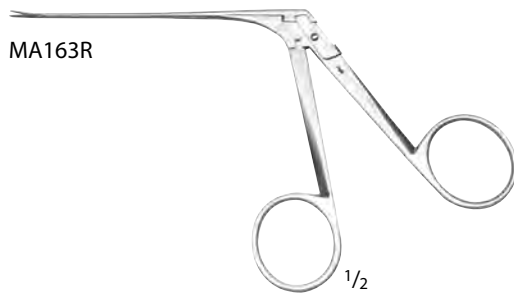

HOUSE Alligator Ear Forceps,
 Horizontal Opening

Catalog Number	Tip Size (mm)	Jaw	Working Length (in.)
MA163R	6	SERR	3 1/8



HOUSE Miniature Alligator Ear Forceps,
 Delicate

Catalog Number	Tip Size (mm)	Jaw	Working Length (in.)
MA165R	4	SERR	3 1/8



HOUSE Strut Forceps

Catalog Number	Tip Size (mm)	Jaw	Working Length (in.)
MA164R	6	STR, SMOOTH	3 1/8



MA168R



MA169R

NOYES Ear Forceps

Catalog Number	Tip Size (mm)	Jaw	Working Length (in.)
MA168R	6	SERR	3
MA169R	7	SERR, 1 x 2 TEETH	3

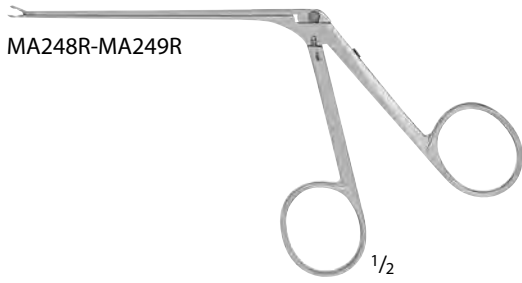

Cup Forceps

Catalog Number	Jaw	Cup Size (mm)	Working Length (in.)
MA249R	FINE	0.7 x 1.0	2 3/4
MA248R	EXTRA FINE	0.9 x 2.0	2 3/4

HARTMANN-HERZFELD Cup Forceps

Catalog Number	Jaw	Cup Size (mm)	Working Length (in.)
MA240R	STR	1.5	3 1/8
MA241R	STR	3.0	3 1/8
MA242R	UPBITE	2.0	3 1/8

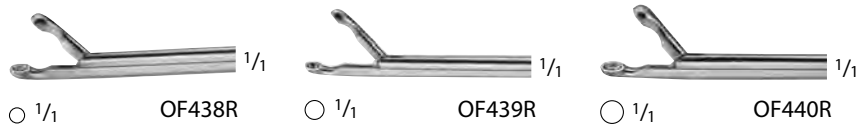
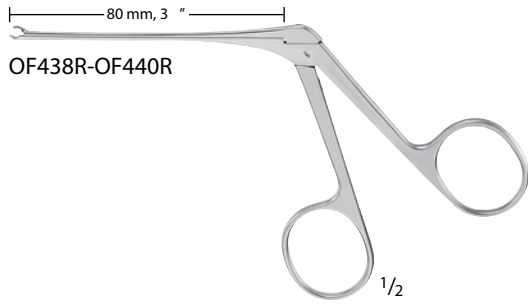

HARTMANN Cup Forceps

Catalog Number	Cup Size (mm)	Jaw	Working Length (in.)
OF438R	2.0	STR	3 1/8
OF439R	2.5	STR	3 1/8
OF440R	3.0	STR	3 1/8

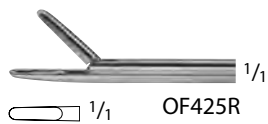
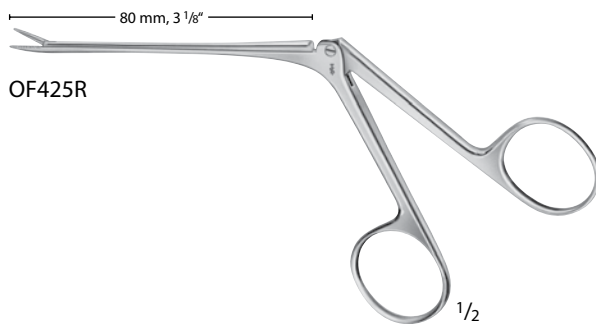

HARTMANN Forceps, Oval

Catalog Number	Cup Size (mm)	Jaw	Working Length (in.)
OF425R	2 x 7	STR	3 1/8

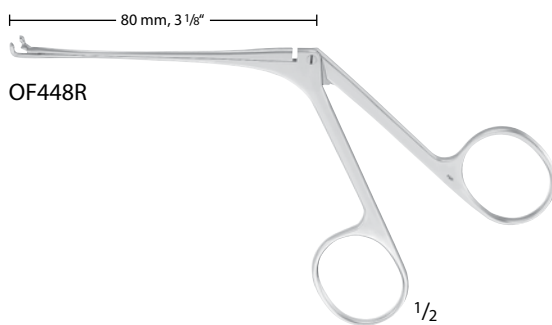

HARTMANN-CITELLI Cup Forceps

Catalog Number	Cup Size (mm)	Jaw	Working Length (in.)
OF448R	2.0	UPBITE	3 1/8

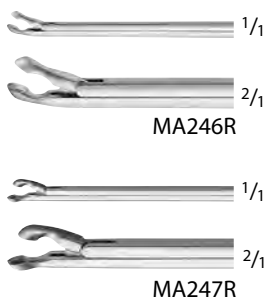
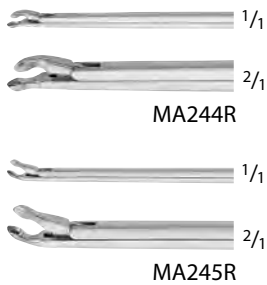
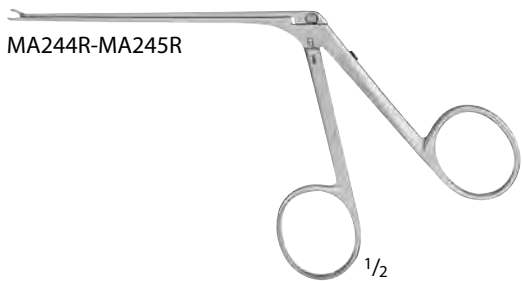

HOUSE Cup Forceps, Miniature

Catalog Number	Cup Size (mm)	Jaw	Working Length (in.)
MA243R	0.6 x 1.0	STR	3 1/8
MA244R	0.6 x 1.0	ANG 15° LEFT	5 1/8
MA245R	0.6 x 1.0	ANG 15° RIGHT	5 1/8

HOUSE Oval Cup Forceps

Catalog Number	Cup Size (mm)	Jaw	Working Length (in.)
MA247R	0.9	ANG 15° LEFT	2 3/4
MA246R	0.9	ANG 15° RIGHT	2 3/4

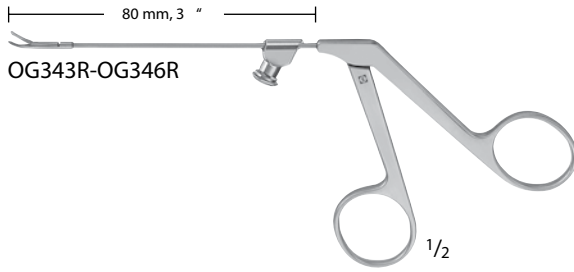

WULLSTEIN Micro Cup Forceps

Catalog Number	Cup Size (mm)	Jaw	Working Length (in.)
OG345R	0.8 x 1.3	STR	3 1/8
OG348R	1.7 x 2.5	STR	3 1/8
OG343R	0.8 x 1.3	CVD-LEFT	3 1/8
OG344R	0.8 x 1.3	CVD-RIGHT	3 1/8
OG346R	1.0	STR, ROUND	3 1/8

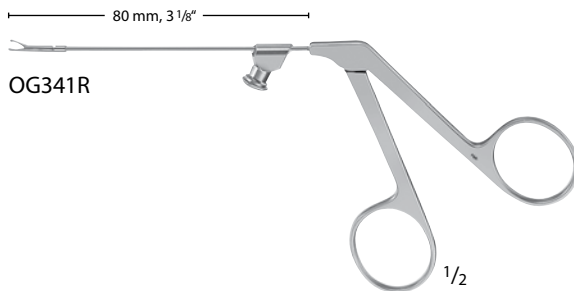
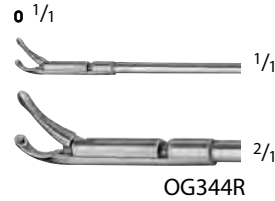
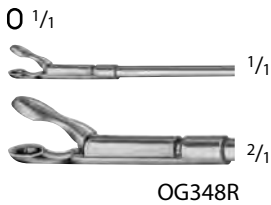
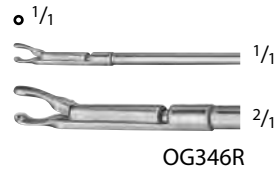
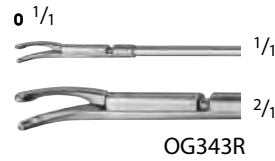
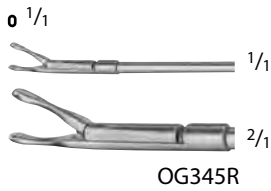

Micro Cup Forceps

Catalog Number	Cup Size (mm)	Jaw	Working Length (in.)
OG341R	0.9 x 1	STR	3 1/8
OG342R	0.9 x 1	CVD, UP	3 1/8

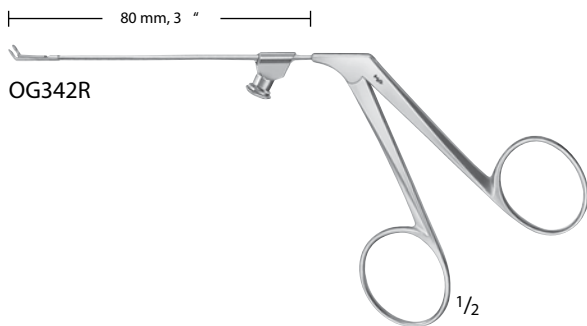

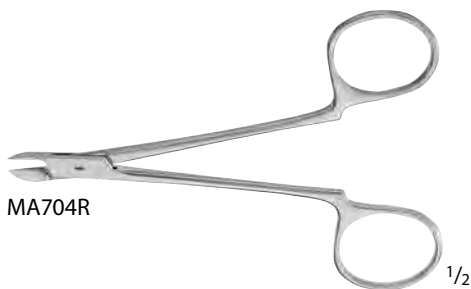
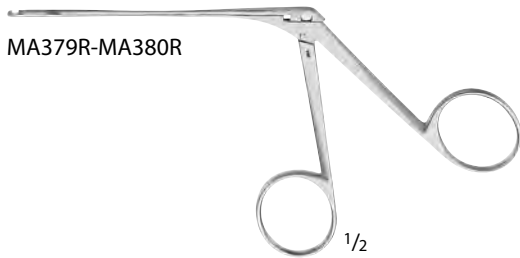
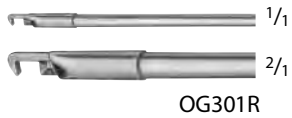
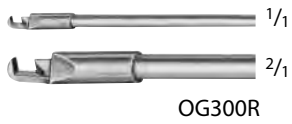
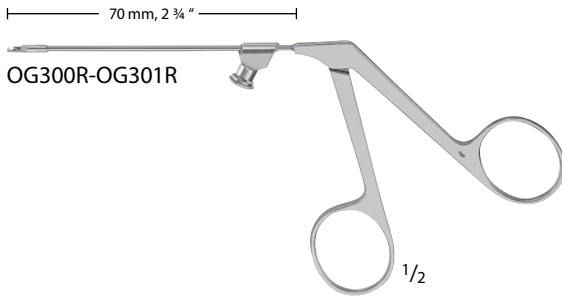

DIETER Malleus Nipper

Catalog Number	Tip	Working Length (in.)
OG300R	UP BITE	2 3/4
OG301R	DOWN BITE	2 3/4

HOUSE-DIETER Malleus Nipper

Catalog Number	Jaw Length (mm)	Working Length (in.)
MA379R	1.5	3 1/8
MA380R	2.0	3 1/8

LEMPERT Malleus Cutter

Catalog Number	Jaw Length (mm)	Length (in.)
MA704R	11	4 1/2

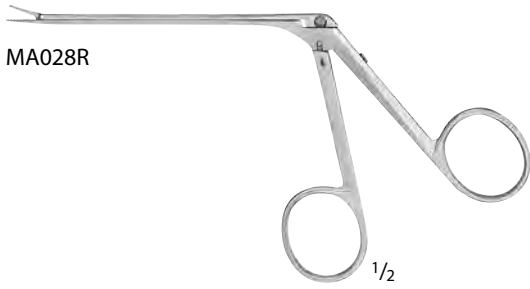

HOUSE Alligator Crimper

Catalog Number	Jaw Length (mm)	Tip	Working Length (in.)	Length (in.)
MA028R	8	SERR	2 7/8	5 1/8

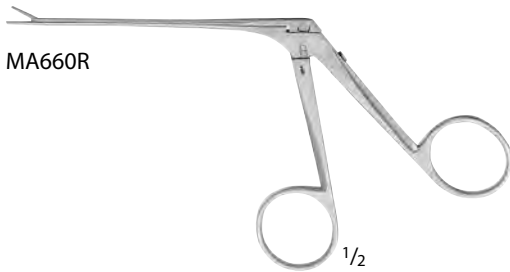

SCHEER Wire Crimper

Catalog Number	Jaw Length (mm)	Tip	Working Length (in.)	Length (in.)
MA660R	7	SMOOTH	3 1/4	5 1/8



SCHUKNECHT Wire Crimper

Catalog Number	Jaw Length (mm)	Working Length (in.)	Length (in.)
MA662R	3	3 1/8	5 1/8

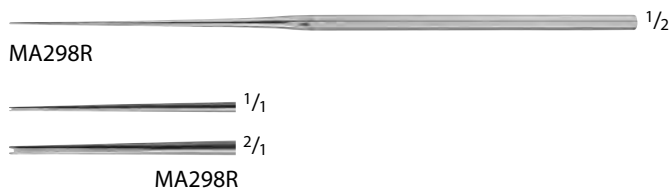
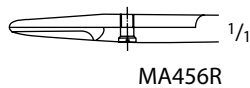
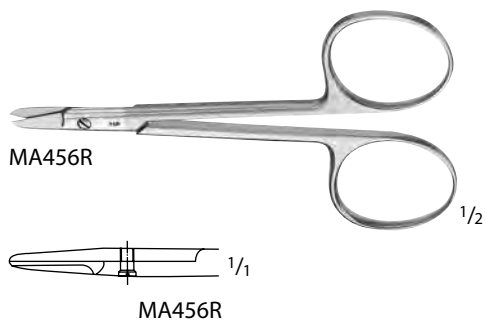
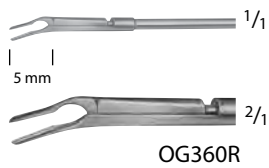
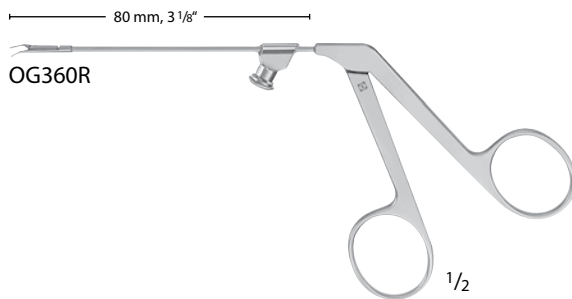
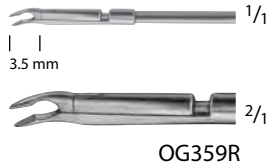
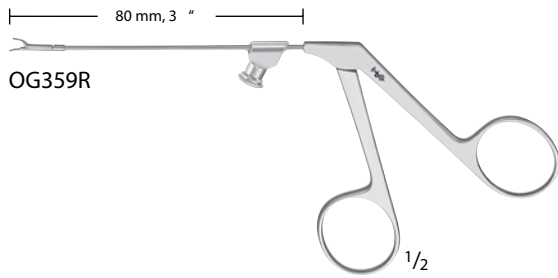

MCGEE Wire Crimper

Catalog Number	Tip Size (mm)	Blade	Working Length (in.)
OG359R	3.5	CVD-DOWN	3 1/8
OG360R	5	CVD-DOWN	3 1/8

GUILFORD-WRIGHT Wire Cutter

Catalog Number	Jaw	Length (in.)
MA456R	SERR	3 3/8

HOUSE Strut Guide

Catalog Number	Tip Size (mm)	Tip	Length (in.)
MA298R	0.6	ANG	6 1/2



Ear Snare Wire, Pkg/100

Catalog Number	Diameter (mm)
OF528R	0.2



KRAUSE Ear Snare, Extra Delicate

Catalog Number	Length (in.)
OF505R	6 1/4

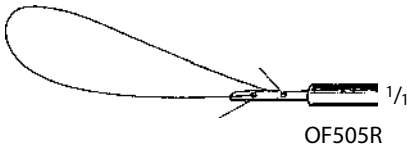

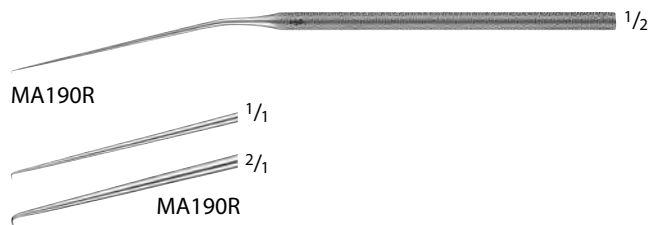
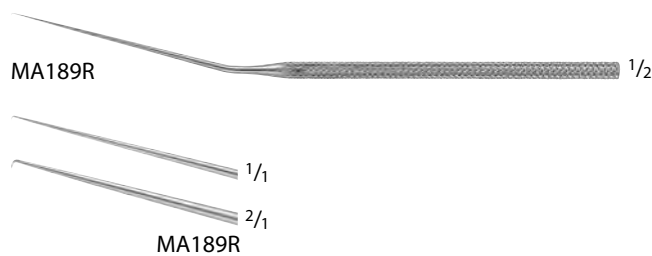
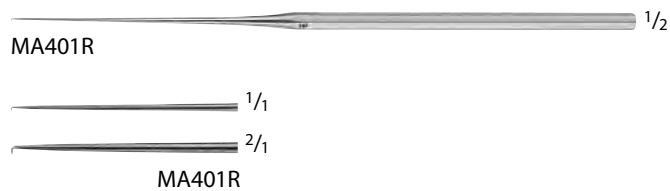
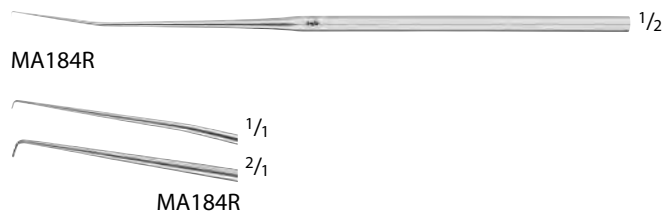
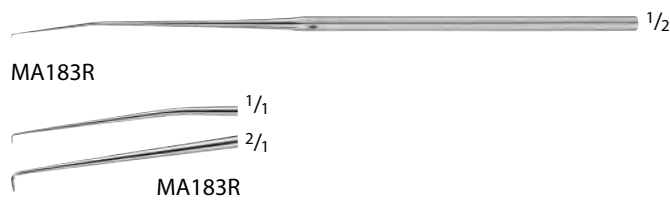
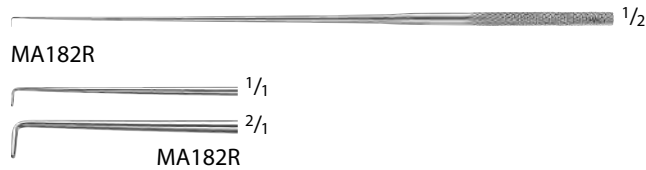
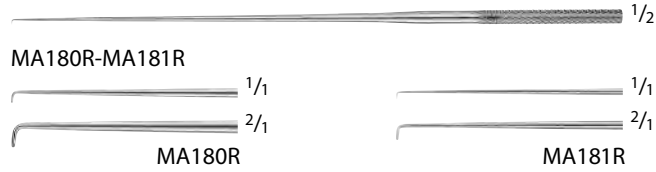

DAY Ear Hook

Catalog Number	Size	Tip Size (mm)	Tip	Length (in.)
MA180R	X-SMALL	1.5	ANG 90°	6 1/4
MA181R	SMALL	2.0	ANG 90°	6 1/4
MA182R	LARGE	2.5	ANG 90°	6 1/4

HOUSE Hook Ear Hook

Catalog Number	Tip Size (mm)	Tip	Length (in.)
MA183R	1	ANG 90° LEFT	6 5/8
MA184R	1	ANG 90° RIGHT	6 5/8

SAUNDERS-PAPARELLA Stapes Hook

Catalog Number	Tip Size (mm)	Tip	Tip Size (#)	Length (in.)
MA401R	0.5	ANG 90°, MALLEABLE	9	6 1/2

SCHUKNECHT Hook

Catalog Number	Tip Size (mm)	Tip	Length (in.)
MA189R	0.4	ANG-UP, ANTERIOR	6 1/4
MA190R	0.6	ANG-DOWN, POSTERIOR	6 1/4

OG007R-OG014R 1/2

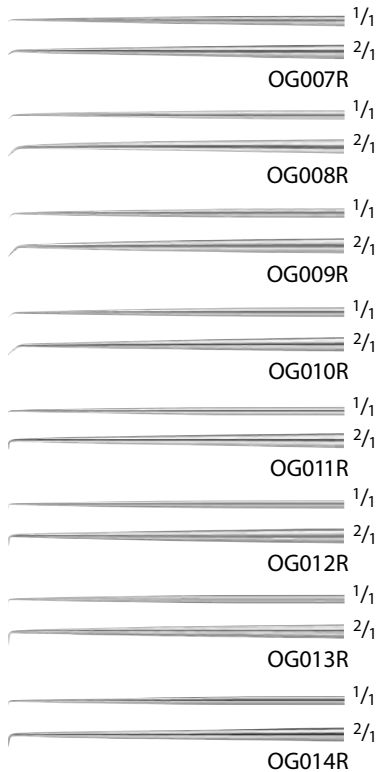

SHAMBAUGH Fen Hook

Catalog Number	Tip Size (mm)	Angle	Length (in.)
OG007R	0.4	45°	6 1/4
OG008R	0.6	45°	6 1/4
OG009R	0.8	45°	6 1/4
OG010R	1.0	45°	6 1/4
OG011R	0.4	90°	6 1/4
OG012R	0.6	90°	6 1/4
OG013R	0.8	90°	6 1/4
OG014R	1.0	90°	6 1/4

OF277R-OF279R 1/2

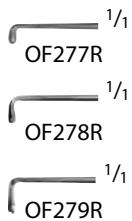

LUCAE Ear Hook Button

Catalog Number	Size	Length (in.)
OF277R	SMALL	5 1/2
OF278R	MEDIUM	5 1/2
OF279R	LARGE	5 1/2

OF282R-OF285R 1/2

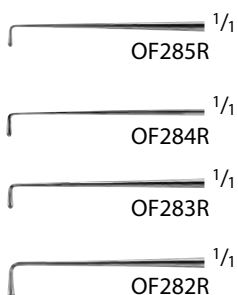

WAGENER Nerve Hook Button

Catalog Number	Size	Length (in.)
OF285R	X-SMALL	6
OF284R	SMALL	6
OF283R	MEDIUM	6
OF282R	LARGE	6



BV030R



BV030R



BV032R



BV032R



BV033R

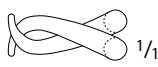

BV033R



BV078R

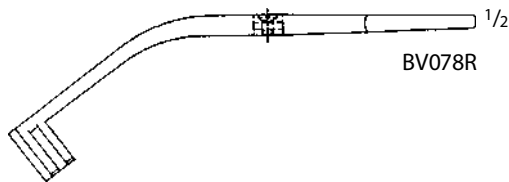

BV078R



1/1

JANSEN Retractor

Catalog Number	Tip	Blade End	Length (in.)
BV030R	SHARP	3 x 3 PRONGS	4
BV032R	BLUNT	3 x 3 PRONGS	4
BV033R	BLUNT	3 x 4 PRONGS	4

PLESTER-PAPARELLA-WEITLANER
 Retractor

Catalog Number	Tip	Blade End	Length (in.)
BV078R	SHARP	2 x 2 PRONGS	5 1/8

SCHUKNECHT Retractor

Catalog Number	Tip	Blade End	Length (in.)
MA433R	ANG, SHARP	3 x 3 PRONGS	5 1/8



MA433R

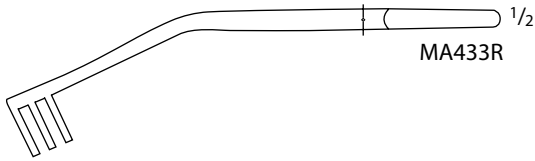

MA433R

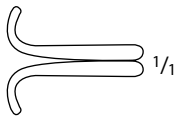

1/1



MA432R

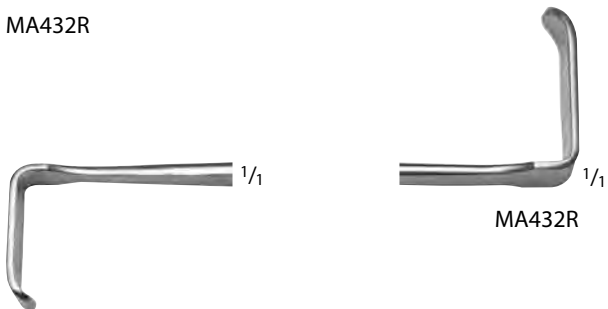

MA432R

HOUSE Hand Retractor, Double Ended

Catalog Number	Blade Size (mm)	Length (in.)
MA432R	20 x 7 / 25 x 9	6

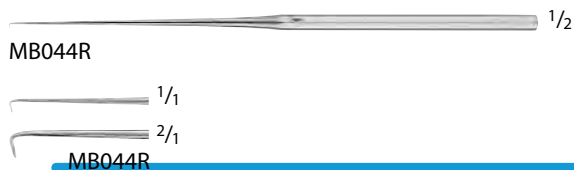
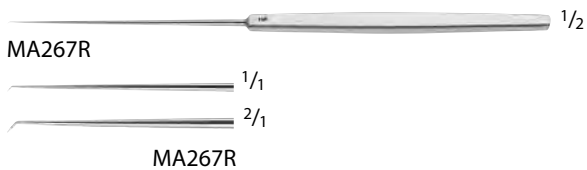
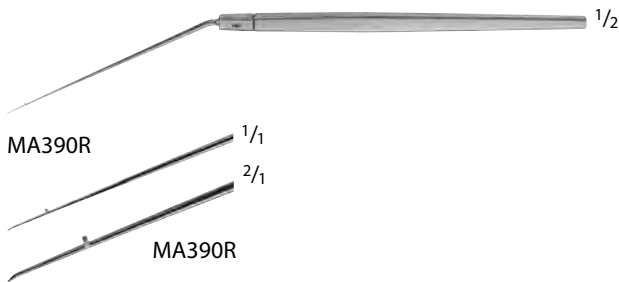
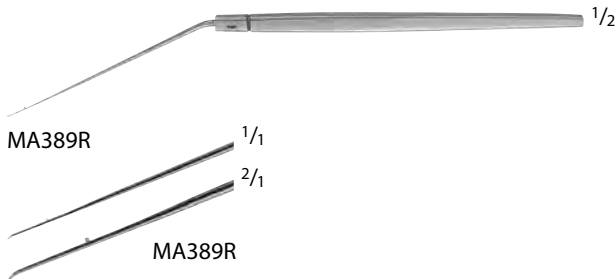
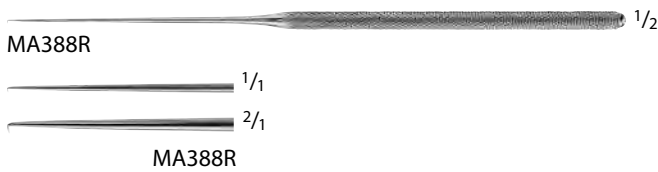
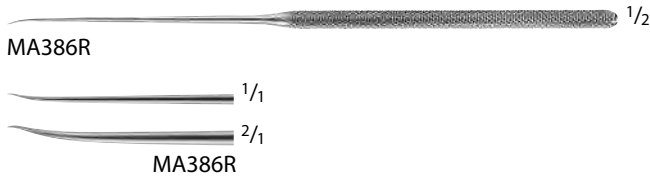
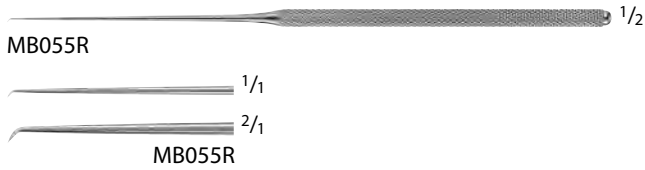

AUSTIN Pick

Catalog Number	Tip Size (mm)	Tip	Length (in.)
MB055R	1.0	ANG 45°	6 1/4

BELLUCCI Pick

Catalog Number	Tip	Tip Size (mm)	Length (in.)
MA386R	CVD POINT, 4 MM FROM TIP	-	6 5/8
MA388R	ANG 90°	0.5	6 5/8

FARRIOR Footplate Pick, with Notch

Catalog Number	Tip	Shaft	Length (in.)
MA389R	ANTERIOR, CVD-RIGHT	ANG	5 7/8
MA390R	POSTERIOR, CVD-LEFT	ANG	5 7/8

GUILFORD-WRIGHT Footplate

Catalog Number	Tip Size (mm)	Tip	Length (in.)
MA267R	0.5	ANG 45°	5 1/2

GUILFORD-WRIGHT Stapes Pick, Heavy

Catalog Number	Tip	Length (in.)
MB044R	ANG 90°	5 1/2

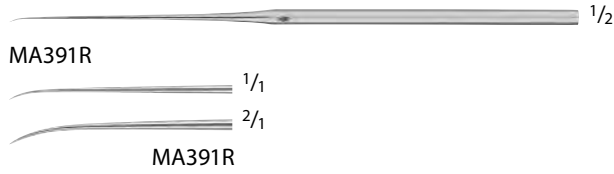

HOUGH Footplate Pick

Catalog Number	Tip	Length (in.)
MA391R	CVD	5 7/8

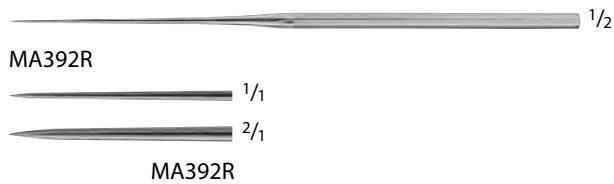

HOUGH Pick

Catalog Number	Tip	Length (in.)
MA392R	STR	5 7/8

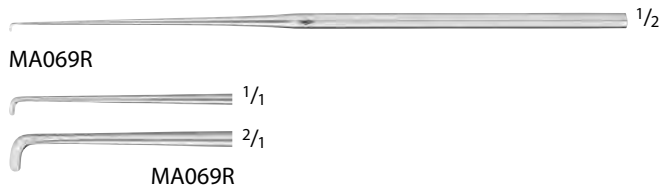

HOUSE-CRABTREE Dissector Pick

Catalog Number	Tip Size (mm)	Tip	Length (in.)
MA069R	2.5	ANG 90°	6 5/8

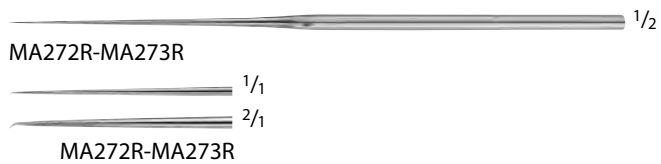

HOUSE Oval Window Pick

Catalog Number	Tip Size (mm)	Tip	Shaft	Length (in.)
MA272R	0.33	ANG 30°	-	6 1/2
MA273R	0.66	ANG 30°	-	6 1/2
MA284R	0.33	ANG 90°	FINE	6 1/2
MA393R	0.33	ANG 90°	MEDIUM	6 5/8

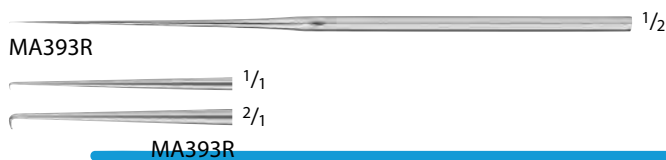
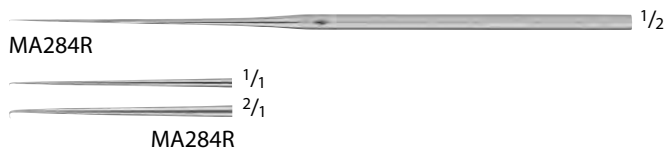

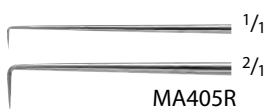

HOUSE Strut Pick

Catalog Number	Tip Size (mm)	Tip	Length (in.)
MA397R	0.5	ANG 90°	6 1/2
MA396R	0.66	ANG 90°	6 1/2
MA395R	0.75	ANG 90°	6 1/2
MA394R	1.0	ANG 90°	6 1/2
MA406R	1.5	ANG 90°	6 1/2
MA405R	3.0	ANG 90°	6 1/2

HOUSE-BARBARA Pick, Malleable

Catalog Number	Tip	Length (in.)
MA251R	STR	6 1/2

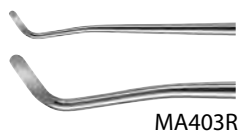
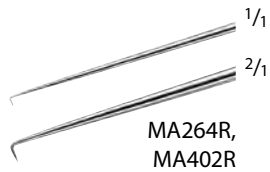
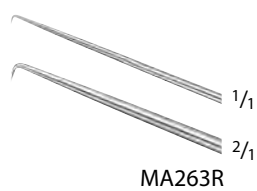
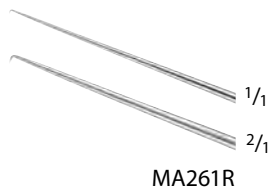

KOS Pick, Bayonet-Shaped

Catalog Number	Tip Size (mm)	Tip	Length (in.)
MA399R	85	STR	7
MA398R	-	ANG-UP 90°	7

MCGEE Footplate Pick

Catalog Number	Tip Size (mm)	Tip	Shaft	Length (in.)
MA261R	0.2	ANTERIOR	ANG-UP	6 1/2
MA402R	0.2	POSTERIOR	ANG-DOWN	6 1/2
MA263R	1.0	ANTERIOR	ANG-UP	6 1/2
MA264R	1.0	POSTERIOR	ANG-DOWN	6 1/2

PAPARELLA Pick

Catalog Number	Tip Size (#)	Tip	Length (in.)
MA403R	17	LEFT	6 1/2
MA404R	16	RIGHT	6 1/2



US101-US103



OF102C-OF104C



OF121C-OF124C



MA077R-MA080R

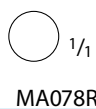
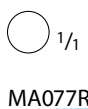

Ear Speculum, Oval, Ebony

Catalog Number	Tip Size (mm)
US101	4.5 x 5.5
US102	5.5 x 6.5
US103	6.5 x 7.5

POLITZER Ear Speculum, Round, Pediatric

Catalog Number	Tip Size (mm)
OF101C	SET OF 3 OF102C-OF104C
OF102C	2
OF103C	3
OF104C	4

BOUCHERON Ear Speculum, Round, Adult

Catalog Number	Tip Size (mm)
OF120C	SET OF 4 OF121C-OF124C
OF121C	4.2
OF122C	5.2
OF123C	6.2
OF124C	7.2

BOUCHERON Ear Speculum, Round, Large

Catalog Number	Tip Size (mm)
MA076R	SET OF 4 MA077R-MA080R
MA077R	5.5
MA078R	6.6
MA079R	7.5
MA080R	9.0



MA072R-MA075R



MA072R



MA073R



MA074R

BOUCHERON Ear Speculum, Round, Small

Catalog Number	Size (#)	Tip Size (mm)
MA071R	-	SET OF 4 MA072R-MA075R
MA072R	1	3.0
MA073R	2	4.0
MA074R	3	4.5
MA075R	4	5.0



MA075R



MA090R-MA096R,
MA648R-MA649R



MA648R



MA649R



MA090R



MA091R



MA092R

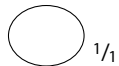

MA093R



MA094R



MA095R

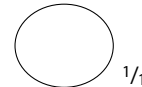

MA096R

FARRIOR Ear Speculum, Oval, Oblique

Catalog Number	Size (#)	Tip Size (mm)
MA648R	XX-SMALL	3 x 4
MA649R	X-SMALL	4 x 5
MA089R	-	SET OF 7 MA090R-MA096R
MA090R	1	5 x 6
MA091R	2	6 x 7
MA092R	3	7 x 8
MA093R	4	8 x 10
MA094R	5	9 x 11
MA095R	6	10 x 12
MA096R	7	11 x 13



MA097R-MA104R



MA098R



MA099R



MA100R



MA101R



MA102R



MA103R



MA104R

FARRIOR Ear Speculum, Round, Oblique

Catalog Number	Size (#)	Tip Size (mm)
MA097R	-	SET OF 7 MA098R-MA104R
MA098R	1	6
MA099R	2	7
MA100R	3	8
MA101R	4	9
MA102R	5	10
MA103R	6	11
MA104R	7	12



MA082R-MA088R,
 MA646R-MA647R



MA646R



MA647R



MA082R



MA083R



MA084R

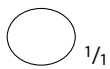

MA085R



MA086R



MA087R



MA088R

FARRIOR Ear Speculum, Oval, Regular

Catalog Number	Size (#)	Tip Size (mm)
MA646R	XX-SMALL	3 x 4
MA647R	X-SMALL	4 x 5
MA081R	-	SET OF 7 MA082R-MA088R
MA082R	1	4.5 x 6
MA083R	2	5.5 x 7
MA084R	3	6.5 x 8
MA085R	4	7.5 x 9
MA086R	5	8 x 10
MA087R	6	9 x 11.25
MA088R	7	10 x 12.5



MA106R-MA112R



MA106R



MA107R



MA108R



MA109R



MA110R



MA111R



MA112R

FARRIOR Ear Speculum, Round, Regular

Catalog Number	Size (#)	Tip Size (mm)
MA105R	-	SET OF 7 MA106R-MA112R
MA106R	1	5.0
MA107R	2	6.0
MA108R	3	7.0
MA109R	4	8.0
MA110R	5	9.0
MA111R	6	10.0
MA112R	7	10.5



MB137R, MA650R-MA652R



MB242R



MB243R



MB244R

GRUBER Ear Speculum, Oval, Infant

Catalog Number	Size (#)	Tip Size (mm)
MB242R	SMALL	2.0 x 2.5
MB243R	MEDIUM	2.5 x 3.0
MB244R	LARGE	3.0 x 4.0



MA117R



MA117R

GRUBER Ear Speculum, Oval, Infant, Long

Catalog Number	Tip Size (mm)
MA117R	4.5 x 5.0



MA119R-MA121R



MA119R



MA120R



MA121R

GRUBER Ear Speculum, Oval, Light

Catalog Number	Size (#)	Tip Size (mm)
MA118R	-	SET OF 3 MA119R-MA121R
MA119R	1	1.6 x 2.4
MA120R	2	2.4 x 3.2
MA121R	3	3.2 x 4.7



MA114R-MA116R



MA114R



MA115R



MA116R

GRUBER Ear Speculum, Oval, Heavy, Long

Catalog Number	Size (#)	Tip Size (mm)
MA114R	1	5 x 6
MA115R	2	6 x 7
MA116R	3	7 x 8



MA125R-MA127R



MA125R



MA126R



MA127R



MA128R



MA130R-MA136R



MA130R



MA136R



OF115C-OF117C



OF115C



OF116C



OF117C



MA132R-MA135R



MA132R



MA133R



MA134R



MA135R

GRUBER Ear Speculum, Round, Short, Light

Catalog Number	Size (#)	Tip Size (mm)
MA124R	-	SET OF 3 MA125R-MA127R
MA125R	1	3 x 33
MA126R	2	4 x 35
MA127R	3	5 x 37

GRUBER Ear Speculum, Round, Long, Heavy

Catalog Number	Description
MA128R	SET OF 3

HARTMANN Ear Speculum, Infant

Catalog Number	Tip	Tip Size (mm)
MA130R	ROUND	2.5
MA136R	OVAL	2.5 x 3

HARTMANN Ear Speculum, Infant

Catalog Number	Tip Size (mm)
OF115C	1.8
OF116C	3.2
OF117C	4.6

HARTMANN Ear Speculum, Oval

Catalog Number	Size (#)	Tip Size (mm)
MA131R	-	SET OF 4 MA132R-MA135R
MA132R	1	4.5 x 5.5
MA133R	2	5.5 x 6
MA134R	3	6.5 x 7
MA135R	4	7.5 x 8



MA129R, MA650R-MA652R



MA650R



MA651R



MA137R



MA652R

HARTMANN Ear Speculum, Round, Adult

Catalog Number	Size (#)	Tip Size (mm)
MA129R	-	SET OF 4 MA137R, MA650R-MA652R
MA650R	1	4
MA651R	2	5
MA137R	3	6
MA652R	4	7



OF111C-OF114C



OF111C



OF112C



OF113C



OF114C

HARTMANN Ear Speculum, Round

Catalog Number	Tip Size (mm)
OF111C	3.5
OF112C	5.0
OF113C	6.5
OF114C	8.0



MA606R

SHEA Speculum Holder

Catalog Number	Length (in.)
MA606R	11 3/4

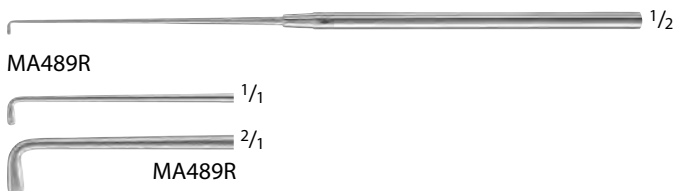
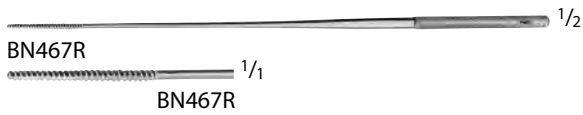

LATHBURY-FARRELL Cotton Applicator,
 Triangular Serrated

Catalog Number	Tip Size (mm)	Length (in.)
BN467R	0.9	5 1/2
BN465R	1.4	5 1/2
BN466R	1.2	6 1/4

Cotton Applicator, Spiral

Catalog Number	Tip Size (mm)	Length (in.)
BN452R	1.5	7
BN457R	1.8	7

FARRELL Cotton Applicator

Catalog Number	Tip Size (mm)	Tip	Length (in.)
BN460R	1.2	ROUND-SERR	5 1/2
BN461R	1.2	SPIRAL	6 1/4

ALLPORT Mastoid Searcher

Catalog Number	Tip Size (mm)	Tip	Length (in.)
MA489R	3	ANG 90°	6 3/4



MA230R

Ear Knife Handle, for Myringotomy
 Blades with Round Ends

Catalog Number	Length (in.)
MA230R	3 5/8



MA204R



MA204R

AUSTIN Dissecting Knife

Catalog Number	Blade Size (mm)	Blade Shape	Length (in.)
MA204R	0.5	ANG 45°	6 1/4



MA210R



MA210R

DERLACKI Capsule Knife

Catalog Number	Blade Size (mm)	Blade Shape	Length (in.)
MA210R	0.25	ANG 20°	6 1/4
MA209R	0.5	SLIGHT CVD	6 1/4



MA209R



MA209R



OG100R



OG100R

Footplate Knife

Catalog Number	Blade Shape	Length (in.)
OG100R	STR	6 1/4

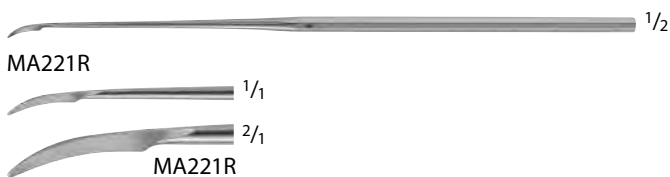
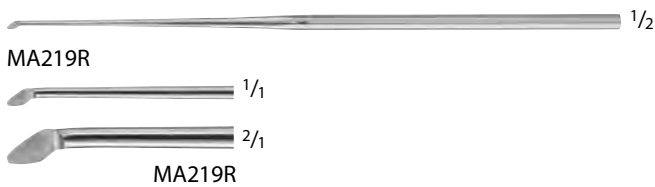
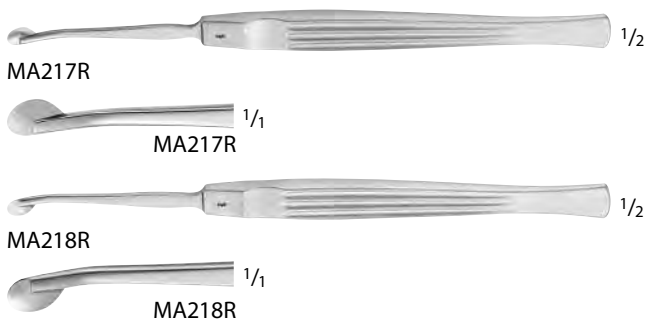
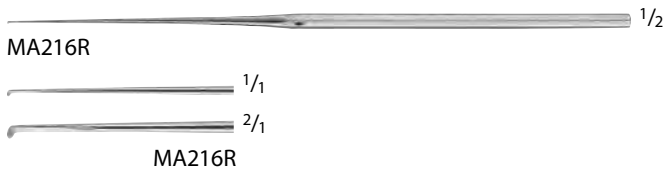
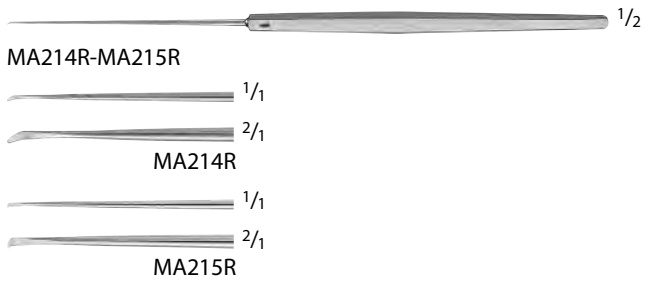
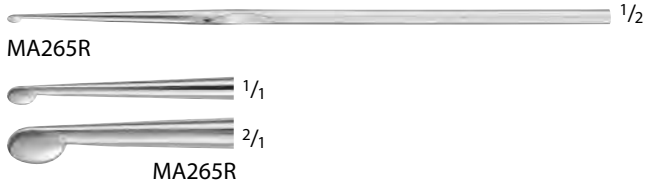

GUILFORD-WRIGHT Flap Knife

Catalog Number	Blade Size (mm)	Length (in.)
MA265R	3.6 x 2.5	6 1/4

HARRISON Knives

Catalog Number	Size	Blade Shape	Length (in.)
MA214R	SMALL	ANG 45°	6 1/8
MA215R	SMALL	ANG 90°	6 1/8

HOUSE Incudostapedial Joint Knife

Catalog Number	Blade Size (mm)	Blade Shape	Length (in.)
MA216R	0.75	ANG 60°	6 5/8

HOUSE Knife

Catalog Number	Blade Size (mm)	Blade Shape	Length (in.)
MA217R	7.0	ANG LEFT	6 1/4
MA218R	7.0	ANG RIGHT	6 1/4
MA219R	2 x 3	ANG 45°	6 1/2
MA221R	7.5	ANG 45°	6 1/2

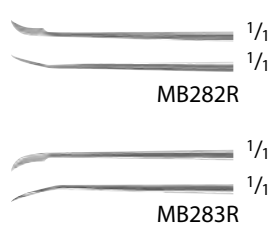
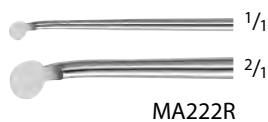
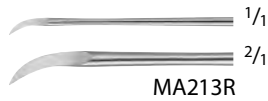

GHANDI Knife, Sickle Blade

Catalog Number	Blade Size (mm)	Length (in.)
MA213R	4.0	5 1/8

CULBERTSON Canal Knife

Catalog Number	Tip Size (mm)	Length (in.)
MA208R	1.4	6 1/4

JORDAN Canal Knife

Catalog Number	Blade Size (mm)	Blade Shape	Length (in.)
MA278R	2 x 3	ANG 45°	6 1/2

MCCABE Canal Knife

Catalog Number	Blade Size (mm)	Blade Shape	Length (in.)
MA222R	2.5	ANG 45°	6 1/4

PAPARELLA Canal Knife

Catalog Number	Size (#)	Blade Size (mm)	Blade Shape	Length (in.)
MA227R	1	2	STR	6 1/2
MA228R	2	2	STR	6 1/2

PAPARELLA Sickle Knife

Catalog Number	Size (#)	Blade Size (mm)	Blade Shape	Length (in.)
MB282R	14	5	CVD RIGHT	6 1/2
MB283R	15	5	CVD LEFT	6 1/2

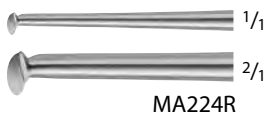

MCCABE Knife Flap Dissector, Double Ended, Angled

Catalog Number	Blade Shape	Length (in.)
MA223R	20° / 45°	7 1/4
MB176R	20° / 40°	7 1/4

MCHUGH Flap Knife

Catalog Number	Blade Shape	Length (in.)
MA224R	OVAL	6 1/2

Myringotomy Knife

Catalog Number	Blade Size (mm)	Blade Shape	Length (in.)
MA225R	8	STR	6 1/2
MA226R	9	CVD	6 1/2

PLESTER Knife, Sickle Knife

Catalog Number	Blade Shape	Length (in.)
OG101R	CVD	6 1/4

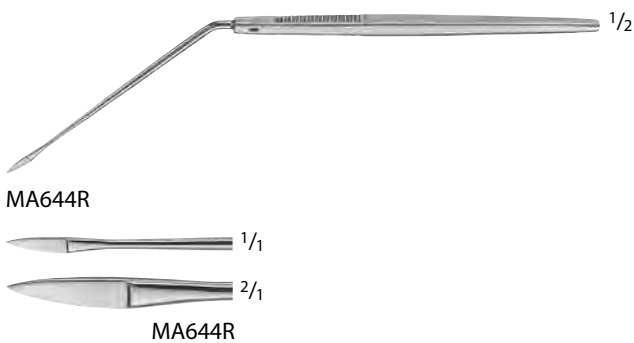
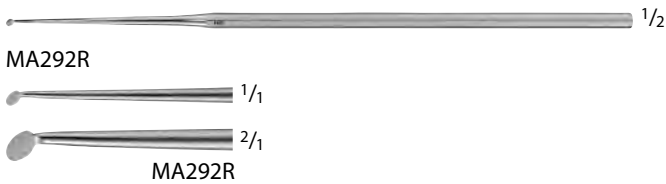
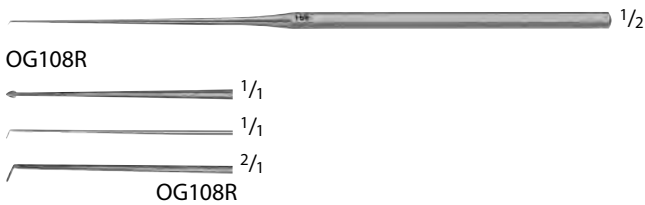
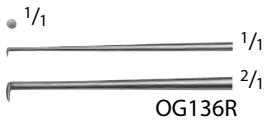
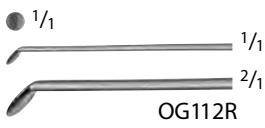
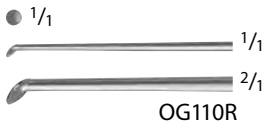
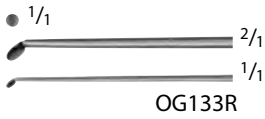

Round Cutting Knife

Catalog Number	Blade Size (mm)	Blade Shape	Length (in.)
OG133R	1.5	45°	6 1/4
OG110R	2.0	45°	6 1/4
OG112R	2.6	45°	6 1/4
OG136R	1.5	90°	6 1/4

ROSEN Knife

Catalog Number	Blade Size (mm)	Blade Shape	Length (in.)
OG108R	-	SPEAR	6 1/4
MA292R	2	45° UP ROUND	6 1/4

ROYCE Ear Knife

Catalog Number	Blade	Blade Size (mm)	Shaft	Length (in.)
MA644R	DOWN-CUTTING	8	ANG	6 1/4



OG123R-OG124R



OG123R



OG124R



MA056R-MA057R



MA056R



MA057R



MA586R



MA586R



MA587R



MA587R

SCHUKNECHT Roller Knife

Catalog Number	Blade Shape	Length (in.)
OG123R	RIGHT-ANG	6 1/4
OG124R	STR	6 1/4

SHEEHY Knife Curette

Catalog Number	Size	Blade Size (mm)	Blade Shape	Length (in.)
MA056R	SMALL	2.0	WEAPON	6 5/8
MA057R	LARGE	2.5	WEAPON	6 5/8

Sickle Knife

Catalog Number	Blade Tip	Blade Size (mm)	Blade Shape	Length (in.)
MA586R	SHARP	10	CVD	7 1/2
MA587R	BLUNT	10	CVD	7 1/2

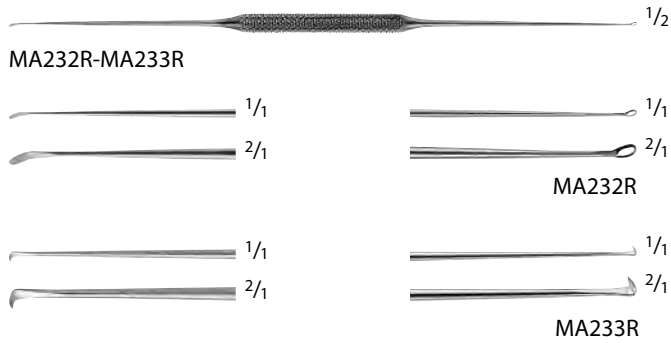

TABB Flap Knife, Double Ended, Angled

Catalog Number	Blade Size (mm)	Blade Shape	Length (in.)
MA232R	0.9 / 1.0	25° / 45°	6 1/2
MA233R	0.9 / 1.0	90° / 115°	6 1/2

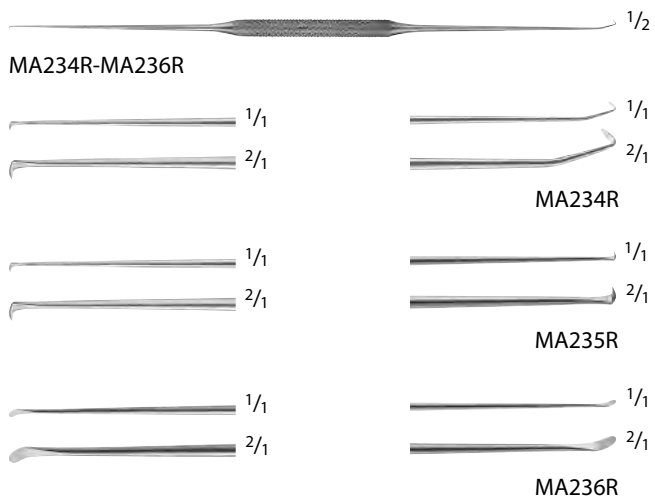

TABB Myringotomy Knife, Double Ended, Angled

Catalog Number	Blade Size (mm)	Blade Shape	Length (in.)
MA234R	1.0 / 1.0	90° / 120°	6 1/4
MA235R	1.3 / 1.3	90° / 115°	6 1/4
MA236R	1.1 / 1.1	25° / 45°	6 1/4

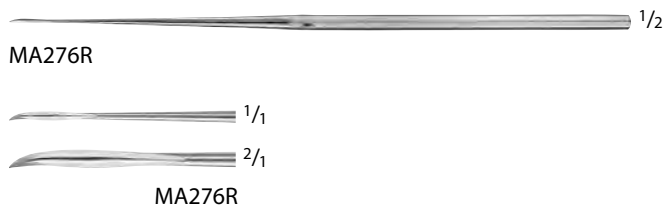

HOUSE Tympanoplasty Knife

Catalog Number	Blade Size (mm)	Blade Shape	Length (in.)
MA276R	7	CVD	6 1/2



MA717R-MA718R

ANTHONY Suction Tube, Straight

Catalog Number	Tip Size (mm)	Length (in.)
MA717R	2 I.D.	6 1/8
MA718R	3 I.D.	6 1/8

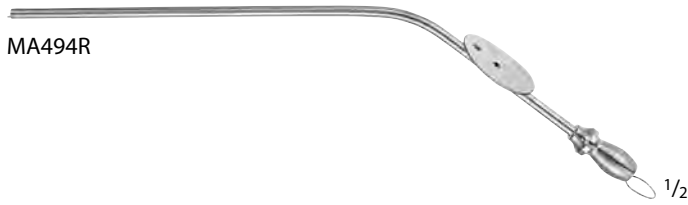

MA494R

BARNES Hospital Suction Tube

Catalog Number	Tip Size (FR)	Working Length (in.)	Length (in.)
MA494R	9	3 3/4	6 1/8



MB380R-MB382R

BARON Suction Tube

Catalog Number	Tip Size (FR)	Working Length (in.)	Length (in.)
MB380R	3	4	4
MB381R	5	4	4
MB382R	7	4	4
MD887	3	2 3/4	5 1/2
MD888	5	2 3/4	5 1/2
MD889	7	2 3/4	5 1/2
MG375R	-	-	6

MG375R Stylet may be used with all
 BARON Suction Tubes



MD887-MD889



MG375R

MA502R



MA503R



MA497R



MA498R



MA495R



MA496R



MB614R-MB616R



HOUSE-BARON Suction Tube, Long

Catalog Number	Tip Size (FR)	Working Length (in.)	Length (in.)
MA502R	3	3 5/8	5 1/2
MA503R	5	3 5/8	6 1/8

BRACKMANN Suction Tube

Catalog Number	Tip Size (FR)	Working Length (in.)	Length (in.)
MA497R	5	3	6
MA498R	7	3	6
MA495R	5	4 1/8	6
MA496R	7	4 1/8	6

HOUSE Suction Tube, Straight

Catalog Number	Tip	Length (in.)
MB614R	18 GA	4 1/8
MB615R	20 GA	4 1/8
MB616R	22 GA	4 1/8

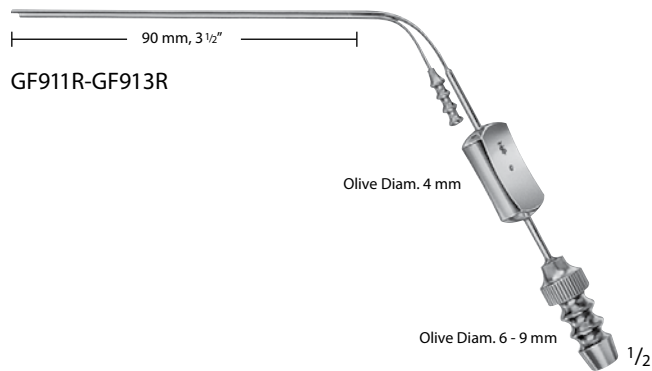

HOUSE Suction Irrigation Cannula

Catalog Number	Tip Size (mm)	Working Length (in.)
GF911R	0.9 / 0.7	3 1/2
GF912R	1.2 / 0.9	3 1/2
GF913R	1.5 / 1.2	3 1/2



WILLIAM-HOUSE Suction Irrigator

Catalog Number	Tip Size (FR)	Working Length (in.)	Length (in.)
MA524R	2.5 x 4	2 3/4	4 1/2
MA526R	4 x 5	3	4 1/2
MA525R	2.5 x 4	3	5 1/2
MA528R	5 x 7	3	5 1/2
MA529R	6 x 8	3	5 1/2
MA530R	7 x 10	3	5 1/2
MA531R	8 x 12	3	5 1/2
MA532R	12 x 14	3	5 1/2
MA523R	2 x 2.5	3 3/8	5 1/8

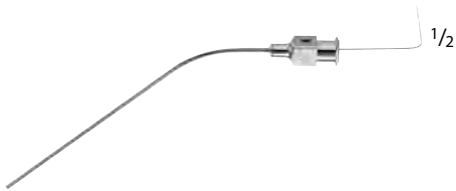

MB450R-MB453R



MA513R-MA522R

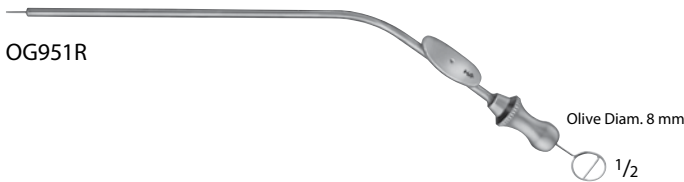

OG951R



GF771R-GF775R

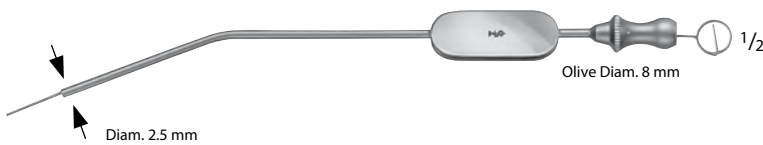

GF770R



GF768R

ROSEN Suction Tube

Catalog Number	Tip	Working Length (in.)	Length (in.)
MB450R	18 GA	2 3/8	3 1/2
MB451R	20 GA	2 3/8	3 1/2
MB452R	22 GA	2 3/8	3 1/2
MB453R	24 GA	2 3/8	3 1/2
MA513R	14 GA	2 3/8	4
MA514R	15 GA	2 3/8	4
MA515R	16 GA	2 3/8	4
MA516R	17 GA	2 3/8	4
MA518R	19 GA	2 3/8	4
MA522R	26 GA	2 3/8	4

BELLUCCI Suction Tube, Detachable Tips

Catalog Number	Diameter (mm)	Description	Length (in.)
OG950R	-	SET	-
OG951R	8	SUCTION TUBE W/ FINGER CUT-OFF AND STYLET	6 1/8

OG950R Includes

1 Suction Tube OG951R and Stylet

ZOELLNER Suction, Tips Only for GF770R

Catalog Number	Tip	Diameter (mm)
GF771R	18 GA	1.2
GF772R	20 GA	1.0
GF773R	22 GA	0.7
GF774R	24 GA	0.5
GF775R	26 GA	0.4

ZOELLNER Suction Tube

Catalog Number	Diameter (mm)	Length (in.)
GF770R	2.5	7

HOUSE Cut-Off Adapter

Catalog Number	Length (in.)
GF768R	2 1/4

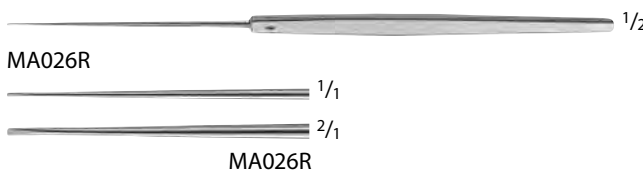
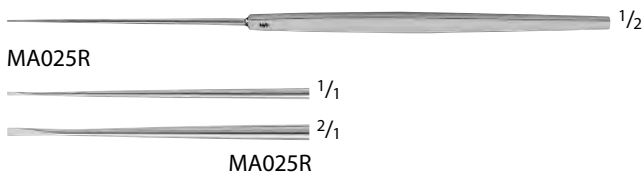
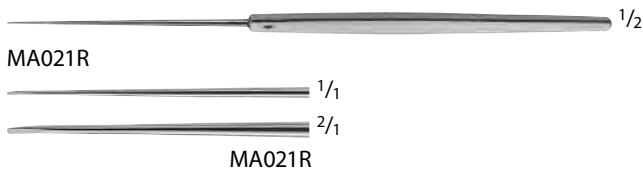
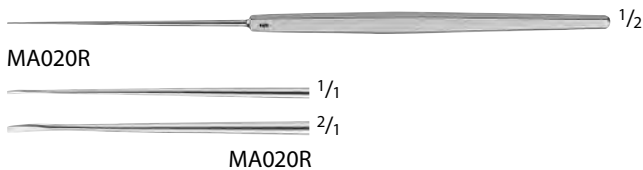
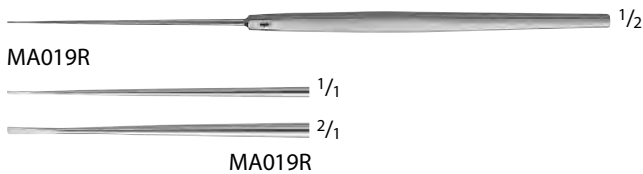
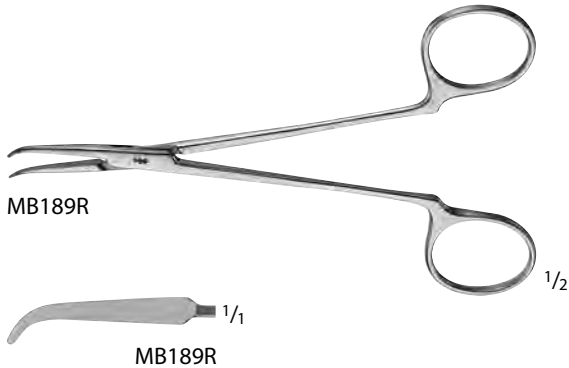
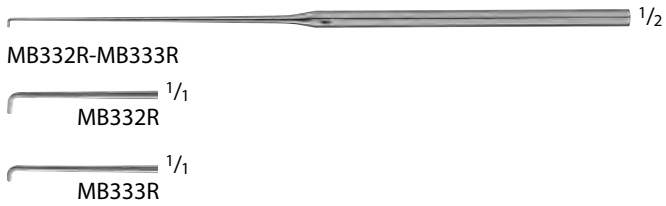

CRABTREE "JIMMY" Dissector

Catalog Number	Tip Size (mm)	Tip	Length (in.)
MB333R	1.3	SMALL	6 1/2
MB332R	2.0	LARGE	6 1/2

MCCABE Facial Nerve Dissector

Catalog Number	Tip Size (mm)	Jaw	Length (in.)
MB189R	25	ANG	5 1/2

DERLACKI Chisel

Catalog Number	Tip Size (mm)	Blade Shape	Length (in.)
MA019R	0.5	STR	6 1/4
MA020R	0.5	ANG 10°	6 1/4
MA021R	0.5	ANG 20°	6 1/4

HOUSE Footplate Chisel

Catalog Number	Tip Size (mm)	Blade Shape	Length (in.)
MA025R	0.6	STR	6 1/4
MA026R	0.6	SLIGHT-CVD	6 1/4



MA175R



MA176R



MA177R

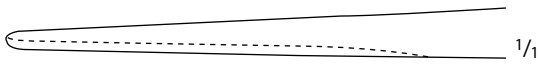

MA175R-MA177R

BISHOP Mastoid Gouge

Catalog Number	Tip Size (mm)	Length (in.)
MA175R	3	6
MA176R	4	6
MA177R	5	6



MA629R



MA629R



MB108R



MB108R

PARKES Hump Gouge, Double Guarded

Catalog Number	Tip Size (mm)	Length (in.)
MA629R	6	7
MB108R	10	7

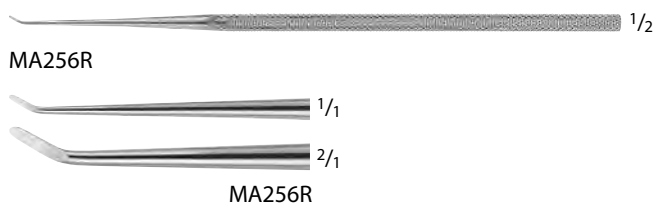
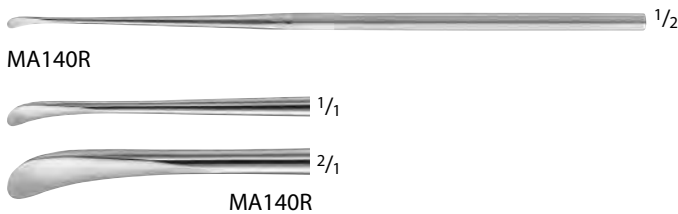
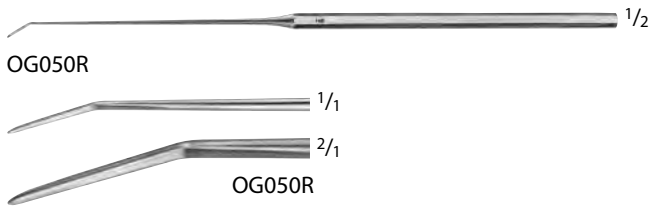
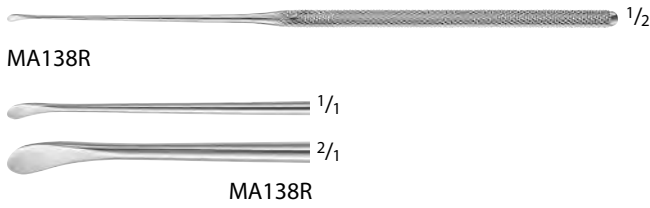

AUSTIN Duckbill Elevator

Catalog Number	Tip Size (mm)	Tip	Length (in.)
MA138R	2	CVD	6 1/4

HOUSE Elevator, Angled

Catalog Number	Tip Size (mm)	Tip	Length (in.)
OG050R	1	ANG	6 1/4

PAPARELLA Duckbill Elevator

Catalog Number	Tip Size (mm)	Size (#)	Length (in.)
MA140R	3	18	6 1/2

GUILFORD-WRIGHT Drum Elevator, Angled

Catalog Number	Tip Size (mm)	Length (in.)
MA255R	2	5 1/2

HOUGH Drum Scraper

Catalog Number	Tip Size (mm)	Tip	Length (in.)
MA256R	0.5	ANG 45°	6 1/4

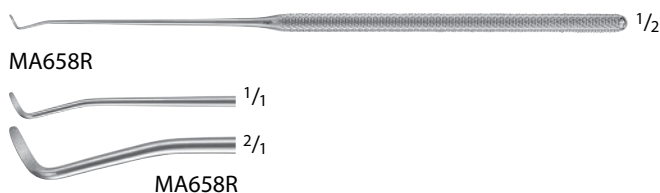
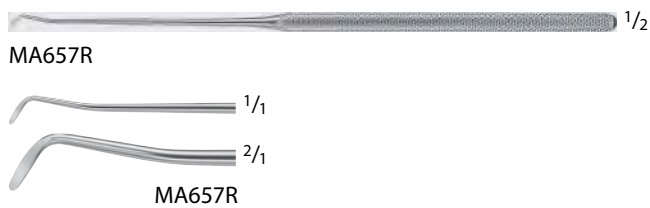
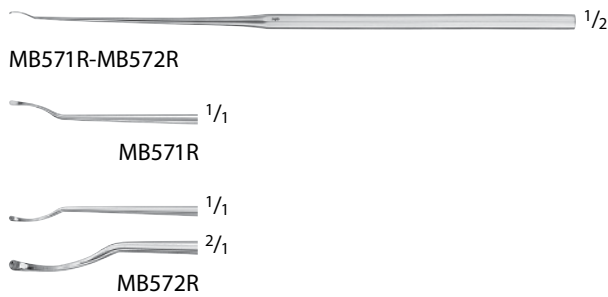
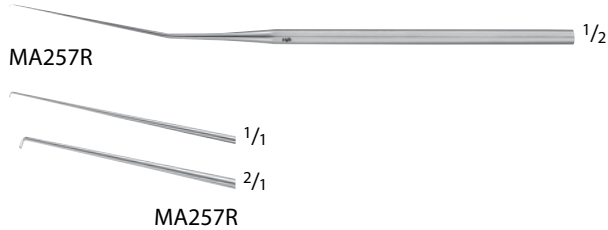
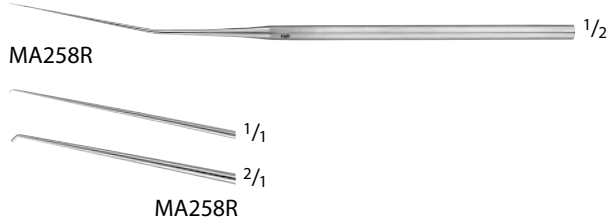
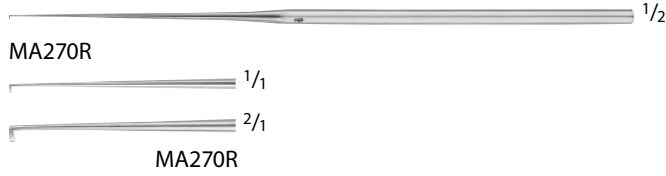

HOUGH Excavator

Catalog Number	Tip Size (mm)	Tip	Length (in.)
MA270R	0.33	ANG 30°	6 1/2
MA258R	0.33	ANG 45°	6
MA257R	0.33	ANG 90°	6

HOUGH Whirlybird Excavator

Catalog Number	Tip Size (mm)	Tip	Length (in.)
MB571R	0.7 x 3.0	CVD-LEFT	6
MB572R	0.7 x 3.0	CVD-RIGHT	6

AUSTIN Excavator

Catalog Number	Tip Size (mm)	Tip	Length (in.)
MA657R	1	ANG LEFT	6 1/4
MA658R	1	ANG RIGHT	6 1/4

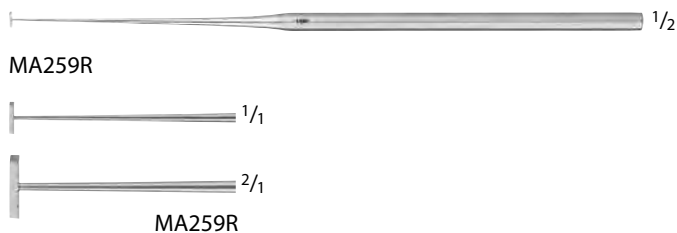
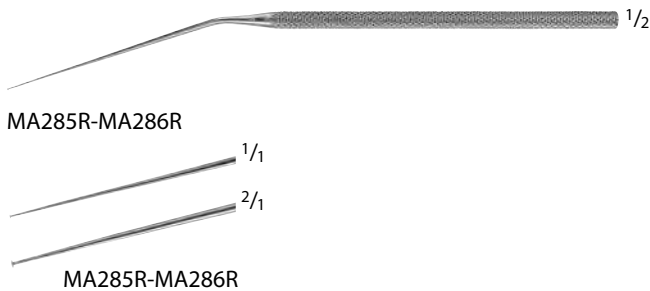
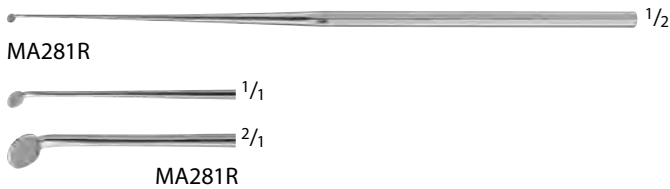
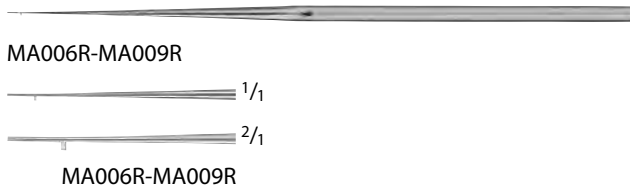

HOUGH Footplate Auger Drill

Catalog Number	Tip Size (mm)	Tip	Length (in.)
MA260R	0.8 x 20.0	DRILL	5 7/8

HOUSE-STRUT Measuring Rod W/ Markers

Catalog Number	Tip Size (mm)	Description	Length (in.)
MA006R	3.5	MEASURING ROD 3.5 MM FROM MARKET TO TIP	6 1/2
MA007R	4.0	MEASURING ROD 4.0 MM FROM MARKET TO TIP	6 1/2
MA008R	4.5	MEASURING ROD 4.5 MM FROM MARKET TO TIP	6 1/2
MA009R	5.0	MEASURING ROD 5.0 MM FROM MARKET TO TIP	6 1/2

Middle Ear Mirror

Catalog Number	Diameter (mm)	Tip	Length (in.)
MA281R	2	ANG 45°	6 1/2

MCGEE Oval Window Rasp

Catalog Number	Size	Length (in.)
MA285R	SMALL	6 3/8
MA286R	LARGE	6 3/8

PAPARELLA Fenestrometer

Catalog Number	Blade Size (mm)	Tip Size (#)	Length (in.)
MA259R	1 x 4	13	6 3/8



MA238R



MA238R



OF271R-OF272R



OF271R



OF272R



MA031R, OF350R-OF354R



MA031R



OF350R-OF354R



MA031R



OF350R



OF351R



OF352R



OF353R



OF354R



MA032R, OF355R-OF359R



MA032R



OF355R-OF359R



MA032R



OF355R



OF356R



OF357R



OF358R



OF359R

BILLEAU Ear Loop

Catalog Number	Tip Size (mm)	Tip	Length (in.)
MA238R	2	SMALL	6 3/8
OF271R	2	MEDIUM	6 1/4
OF272R	3	LARGE	6 1/4

BUCK Ear Curette, Sharp, Curved

Catalog Number	Tip Size (#)	Cup Size (mm)	Length (in.)
MA031R	00	1.0	6
OF350R	00	1.5	6
OF351R	0	2.0	6
OF352R	1	2.5	6
OF353R	2	3.0	6
OF354R	3	4.0	6

BUCK Ear Curette, Blunt, Curved

Catalog Number	Tip Size (#)	Cup Size (mm)	Length (in.)
MA032R	00	1.0	6
OF355R	00	1.5	6
OF356R	0	2.0	6
OF357R	1	2.5	6
OF358R	2	3.0	6
OF359R	3	4.0	6



MA252R



MA252R



MB039R



MB039R



MA279R



MA279R



MA055R



MA055R



MA053R-MA054R



MA053R-MA054R

HOUGH Ear Curette

Catalog Number	Cup Size (mm)	Tip	Size	Length (in.)
MA252R	2.25 x 3 SERR	ANG 30°	LARGE	5 5/8

GUILFORD-WRIGHT Ear Curette, Angled

Catalog Number	Cup Size (mm)	Size	Length (in.)
MB039R	2.4 x 1.4	SMALL	5 1/8
MA279R	2.5 x 3.0	MEDIUM	5 1/4

SHEA Ear Curette, Round

Catalog Number	Cup Size (mm)	Blade	Length (in.)
MA055R	2	ANG	5 1/2

SHAPLEIGH Ear Curette, Angled

Catalog Number	Tip Size (mm)	Tip	Size	Length (in.)
MA053R	1.5	SERR	SMALL	6 1/2
MA054R	2.0	SERR	LARGE	6 1/2

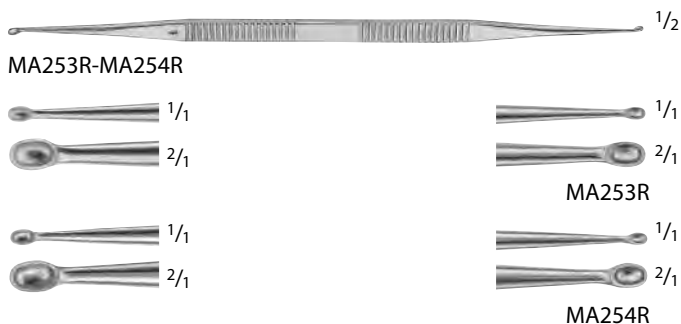
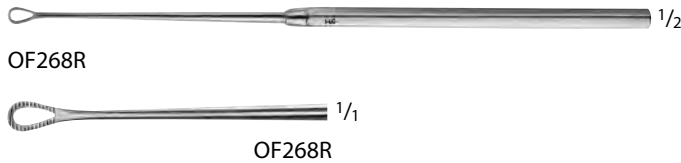

FREIMUTH Ear Curette

Catalog Number	Cup Size (mm)	Tip	Size	Length (in.)
MA653R	2.5 x 4	SERR	SMALL	6 1/4

SNELLEN Ear Curette

Catalog Number	Tip	Blade	Length (in.)
OF268R	SERR	CVD	6 1/4

Ear Curette, Pointed, Double Ended

Catalog Number	Cup Size	Length (in.)
OG189R	LARGE	6 3/4

HOUSE Ear Curette, Double Ended

Catalog Number	Cup Size (mm)	Tip	Length (in.)
OG181R	1.0 / 1.2	ANG	6
OG182R	1.5 / 1.8	ANG	6
OG184R	1.0 / 1.2	STRONG ANG	6
OG185R	1.5 / 1.8	STRONG ANG	6
MA253R	2.0 / 1.7	LIGHT ANG	7
MA254R	2.0 / 2.25	STRONG ANG	7



HOUSE-PAPARELLA Stapes Ear Curette,
 Double Ended

Catalog Number	Cup Size (mm)	Length (in.)
MA035R	1.6 x 3.0 / 2.0 x 3.5	6 1/4

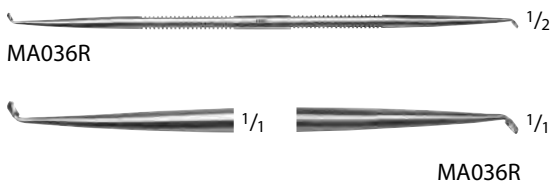

HOUSE Stapes Curette, Double Ended

Catalog Number	Cup Size (mm)	Length (in.)
MA036R	1.8 x 2.5 / 1.5 x 2.4	6

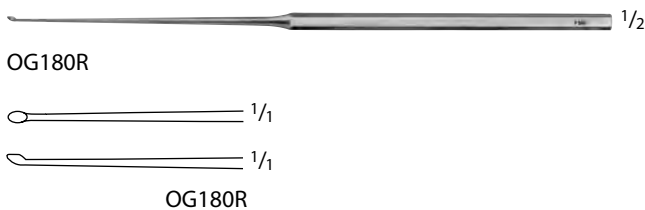

SHEA Bone Curette, Oval

Catalog Number	Cup Size (mm)	Blade	Length (in.)
OG180R	1.5 x 2.5	STR	6 1/4

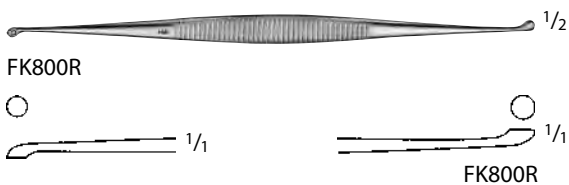

MARTINI Bone Curette, Double Ended

Catalog Number	Cup Size (mm)	Length (in.)
FK800R	3.0 / 3.2	5 1/2
FK801R	4.0 / 3.2	5 1/2

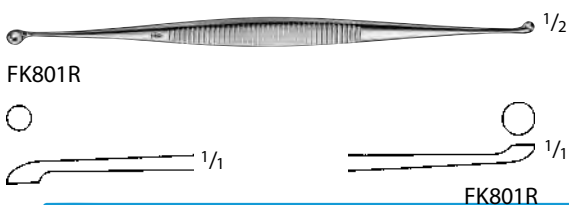



MA051R



MA051R

PAPARELLA Ring Curette

Catalog Number	Cup Size (#)	Blade	Length (in.)
MA051R	12	ANG	6 1/2



MB117R



MB117R

PRATT Ethmoid Curette, Double Ended

Catalog Number	Blade	Length (in.)
MB117R	SOLID/FENESTRATED	9 1/4



MA188R



MA188R

GROSS Ear Hook/Spoon, Double Ended

Catalog Number	Hook	Spoon	Length (in.)
MA188R	90° BLUNT 2.6 MM	3.2 x 7.5 MM	5 1/4



MA439R-MA442R

KERRISON Mastoid Rongeur, 90° Up

Catalog Number	Tip Size (#)	Jaw Size (mm)	Working Length (in.)	Length (in.)
MA439R	0	3.5 x 9	4 1/8	6 3/4
MA440R	1	4.0 x 9	4 1/8	6 3/4
MA441R	2	4.5 x 9	4 1/8	6 3/4
MA442R	3	5.0 x 9	4 1/8	6 3/4



MA439R



MA440R



MA441R



MA442R



OF001N-OF006N

HARTMANN Tuning Fork

Catalog Number	Frequency
MB575A	c 64
OF001N	c 128
OF002N	c1 256
OF003N	c2 512
OF004N	c3 1024
OF005N	c4 2048
OF006N	c5 4096

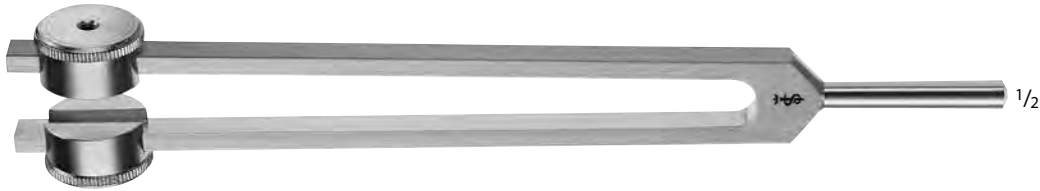

MB575A



MA602R

SHEEHY Fascia Press

Catalog Number	Jaw Size (mm)	Jaw	Description	Length (in.)
MA602R	23 x 31	PLATE	W/ RATCHET BOX LOCK	7 1/2



MA604R

HOUSE Gelfoam Press, with Ratchet

Catalog Number	Jaw Size (mm)	Jaw	Length (in.)
MA604R	12 x 15	PLATE	5 3/8
MA603R	12 x 16	PLATE	7

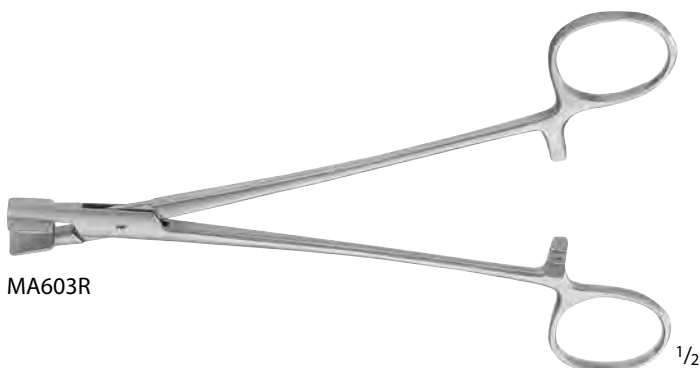

MA603R



MA605R

HOUSE Cutting Block, Delrin

Catalog Number	Dimensions (mm)	Description	Length (in.)
MA605R	8 x 38	AUTOCLAVABLE	2 7/8



OG145R

Surgery Preparation Base W/ mm Scale

Catalog Number	Dimensions (mm)
OG145R	92 x 54



ENT-Nasal

Scissors	596 - 614
Trocar, Needles and Needle Holders	615 - 617
Forceps	618 - 649
Nasal Snares and Wires	650
Hooks	651
Retractors	652 - 657
Elevators and Dissectors	658 - 664
Specula	665 - 673
Rasps, Files and Saws	674 - 677
Chisels and Gouges	678 - 679
Osteotomes	680 - 685
Applicators and Probes	686
Knives	687 - 688
Suction and Irrigation	689 - 692
Mallets, Hammers and Tamps	693 - 694
Curettes	695 - 698
Rongeurs	699 - 703

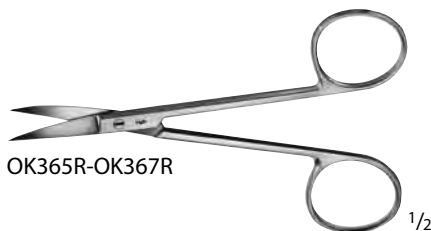
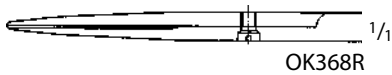
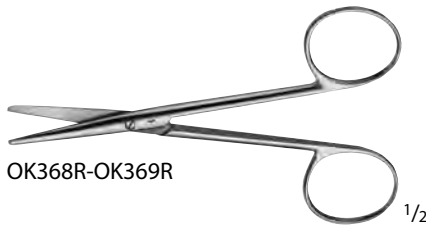
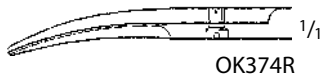
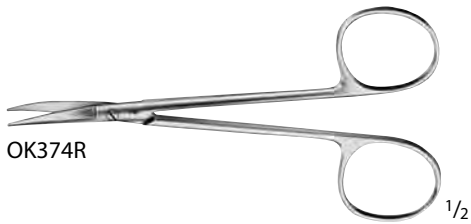
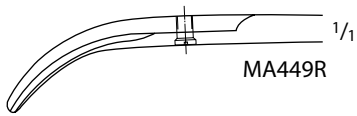

CINELLI Lower Lateral Scissors

Catalog Number	Blade	Length (in.)
MA449R	STRONG CVD	4 3/8

COTTLE Bulldog Scissors

Catalog Number	Tip	Blade	Length (in.)
OK374R	B/B	CVD	4 1/2

COTTLE-KNAPP Plastic Scissors

Catalog Number	Tip	Blade	Length (in.)
OK368R	B/B	STR	4 1/8
OK369R	B/B	CVD	4 1/8

COTTLE-MASING Plastic Scissors

Catalog Number	Tip	Blade	Length (in.)
OK365R	S/S	CVD	4 1/8
OK367R	B/B	CVD	4 1/8

DAVIS Rhytidectomy Scissors

Catalog Number	Blade	Length (in.)
MA450R	CVD	6 3/4

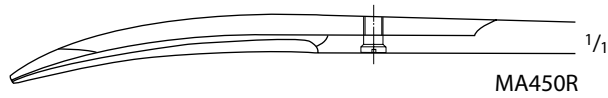

Rhinoplasty Scissors

Catalog Number	Tip	Blade	Length (in.)
MG086R	B/B	FLAT, CVD	5 1/4

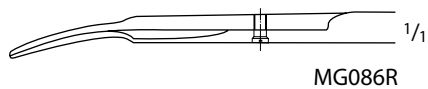



MA335R-MA337R



MA335R



MA336R



MA337R

Nasal Scissors, Pediatric

Catalog Number	Blade	Blade Size (mm)	Length (in.)
MA335R	STR	6	4
MA336R	CVD-RIGHT	5.5	4
MA337R	CVD-LEFT	5.5	4

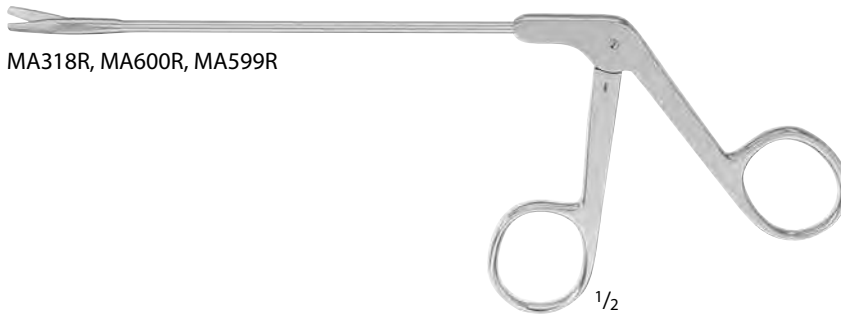

MA318R, MA600R, MA599R



MA318R



MA600R



MA599R

Nasal Scissors, Adult

Catalog Number	Blade	Blade Size (mm)	Working Length (in.)
MA318R	STR	11	5 1/8
MA600R	RIGHT	11	5 1/8
MA599R	LEFT	11	5 1/8



LAKESIDE Nasal Scissors

Catalog Number	Blade	Length (in.)
MA609R	STR	7 1/4

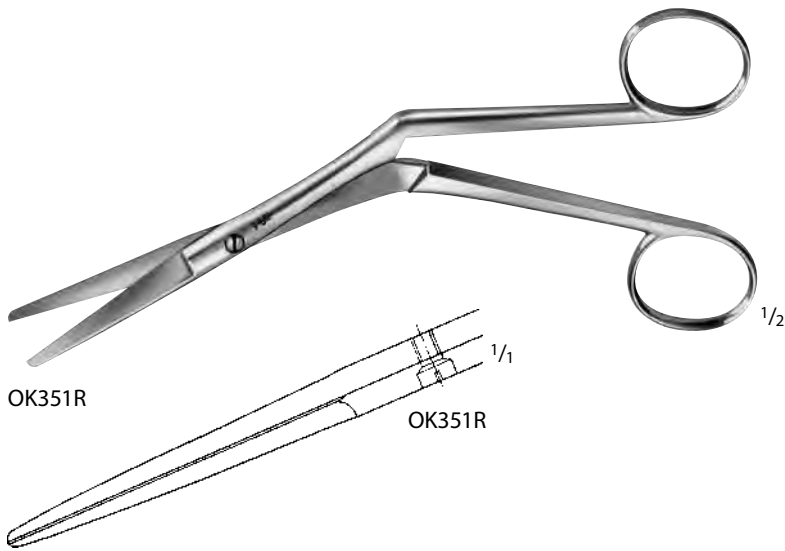

HEYMANN Nasal Scissors

Catalog Number	Tip	Blade	Length (in.)
OK351R	B/B	STR	7 1/2

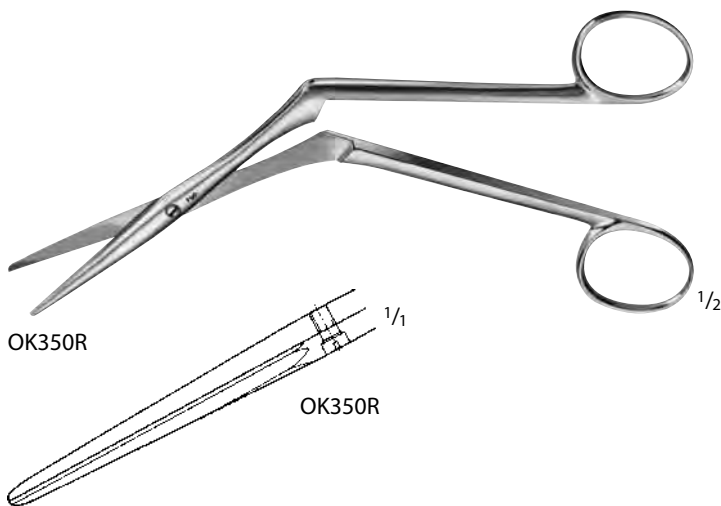

HEYMANN-KNIGHT Nasal Scissors

Catalog Number	Tip	Blade	Length (in.)
OK350R	B/B	STR	6 7/8



MA463R

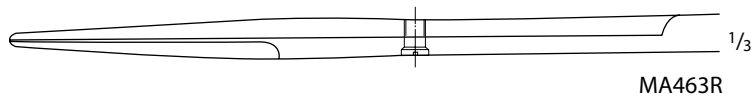

MA463R

KNIGHT Nasal Scissors, Lightweight, Delicate

Catalog Number	Blade	Tip	Length (in.)
MA463R	STR	DEL	6 3/8



MA611R

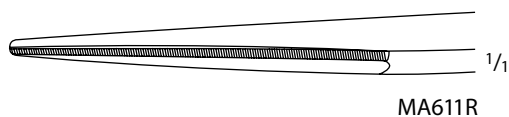

MA611R

JACKSON Nasal Bone Scissors

Catalog Number	Blade	Length (in.)
MA611R	ANG	8 1/2



MA451R

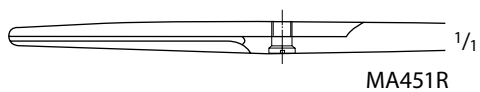

MA451R

Dorsal Scissors

Catalog Number	Tip	Blade	Length (in.)
MA451R	BLUNT	STR	4 3/4

FOMON Dorsal Scissors

Catalog Number	Tip	Blade	Handle	Length (in.)
MA452R	B/B	SERR	ANG	5 3/4
OK370R	B/B	SERR	ANG	5 3/4

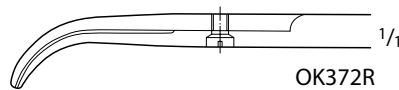
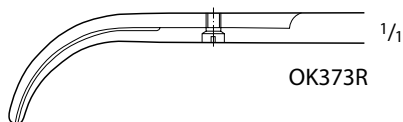
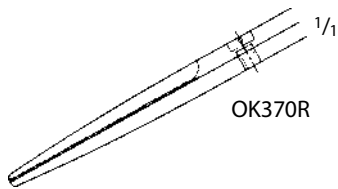
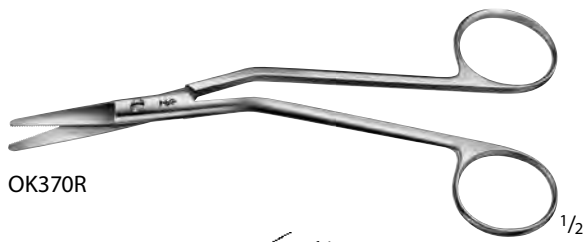
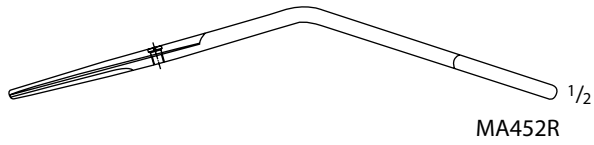

FOMON Lower Lateral Scissors

Catalog Number	Tip	Blade	Length (in.)
OK373R	B/B	HEAVY-CVD	4 1/2
OK372R	B/B	HEAVY-CVD	5 1/4



FOMON Saber-Back Scissors

Catalog Number	Tip	Blade	Length (in.)
MB140R	B/B	CVD, SERR	5

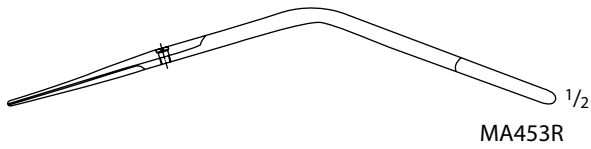

GOLDMAN Septum Scissors

Catalog Number	Blade	Length (in.)
MA453R	STR, SERR	5 3/4

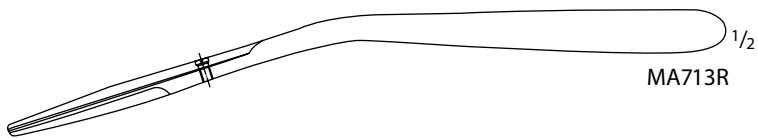

COTTLE Septum Scissors

Catalog Number	Blade	Length (in.)
MA713R	HEAVY, ANG	7 1/2

GORNEY Turbinate Scissors, Double Action

Catalog Number	Jaw	Length (in.)
MA455R	SERR	8



MA455R

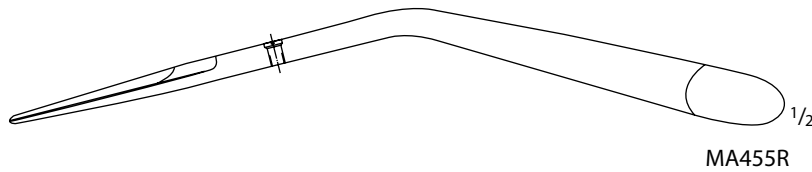

MA455R

Becker Septum Scissors, Double Joint

Catalog Number	Blade	Length (in.)
OK353R	SERR	7



OK353R

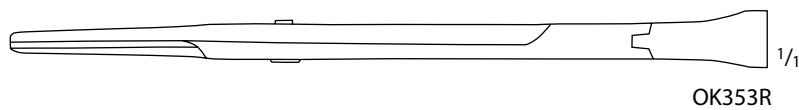

OK353R



MB147R



MB147R

MARTIN Cartilage Scissors

Catalog Number	Blade	Length (in.)
MB147R	CVD, SERR	8



MB150R

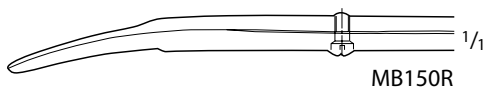

MB150R

METZENBAUM-LIPSETT Scissors

Catalog Number	Tip	Blade	Length (in.)
MB150R	B/B	CVD	5 1/2



MA709R

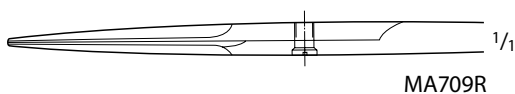

MA709R

PECK-JOSEPH Scissors

Catalog Number	Blade	Tip Size (mm)	Length (in.)
MA709R	STR, SHARP	42	5 3/4

JOSEPH Scissors, Delicate

Catalog Number	Tip	Blade	Handle	Length (in.)
MB174R	S/S	STR, SERR	ROUND	5 1/2
MB175R	S/S	CVD, SERR	ROUND	5 1/2
BC156R	S/S	STR	ROUND	6
BC157R	S/S	CVD	ROUND	6
BC006R	S/S	STR	SQUARE	6
BC007R	S/S	CVD	SQUARE	6

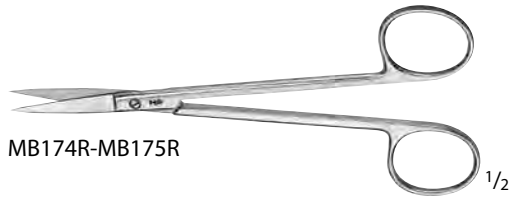

MB174R-MB175R



MB174R



MB175R



BC156R-BC157R

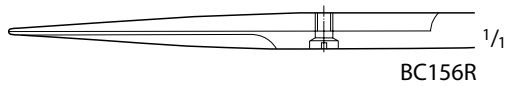

BC156R

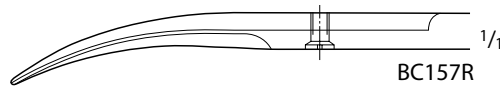

BC157R



BC006R-BC007R

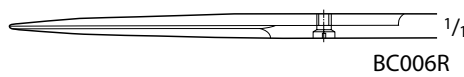

BC006R

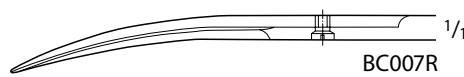

BC007R

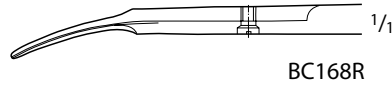
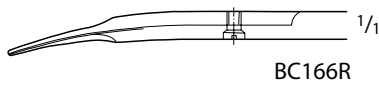
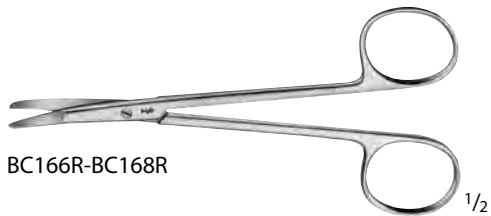
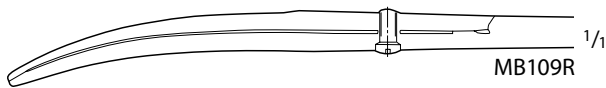
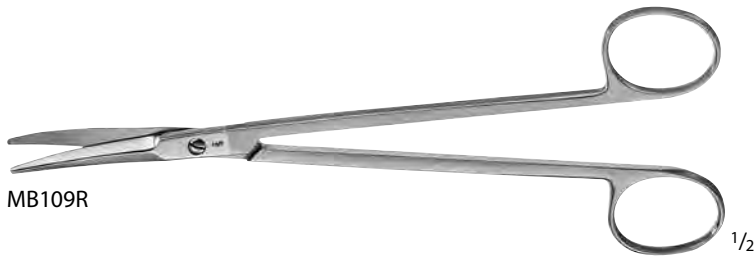
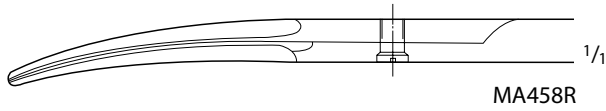

KAYE Facelift Scissors

Catalog Number	Tip	Blade	Length (in.)
MA458R	SEMI-SHARP	CVD, SERR	6
MB109R	SEMI-SHARP	CVD, SERR	7 1/2

KILNER Scissors

Catalog Number	Tip	Blade	Length (in.)
BC166R	FLAT	CVD	5
BC168R	FLAT	CVD	6

JAMESON Tenotomy Scissors, Delicate

Catalog Number	Tip	Blade	Length (in.)
BC177R	B/B	CVD	6

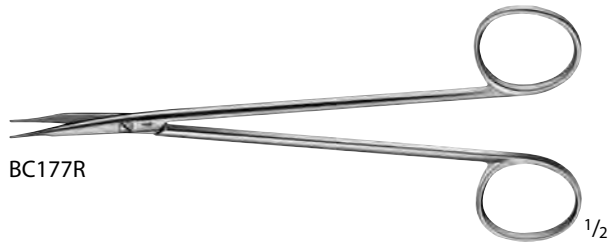

BC177R

1/2

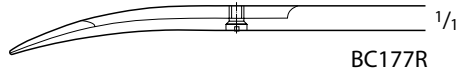

BC177R

1/1

REYNOLDS-JAMESON Tenotomy Scissors, Delicate

Catalog Number	Tip	Blade	Handle	Length (in.)
BC015R	B/B	CVD	SQUARE	5 1/2



BC015R

1/2

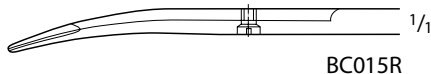

BC015R

1/1

REYNOLDS Tenotomy Scissors, Delicate

Catalog Number	Tip	Blade	Length (in.)
BC180R	B/B	CVD	5 3/4
BC181R	B/B	CVD	6 7/8

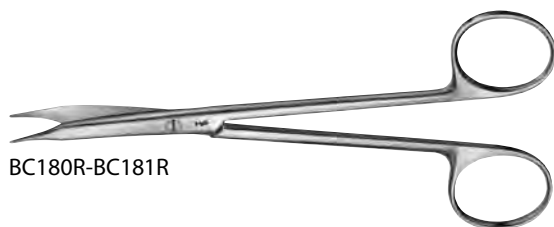

BC180R-BC181R

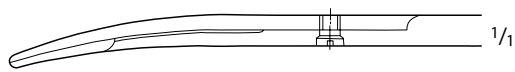

BC180R

1/1

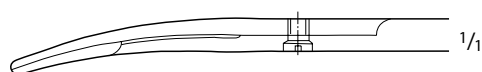

BC181R

1/1

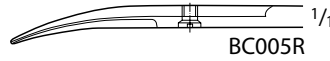
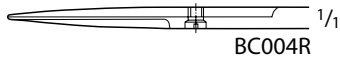
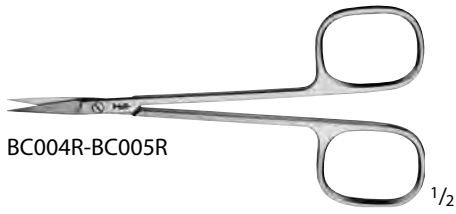

Iris Scissors, Delicate

Catalog Number	Tip	Blade	Handle	Length (in.)
BC004R	S/S	STR	SQUARE	4 1/2
BC005R	S/S	CVD	SQUARE	4 1/2

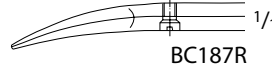
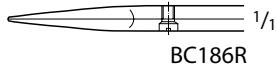
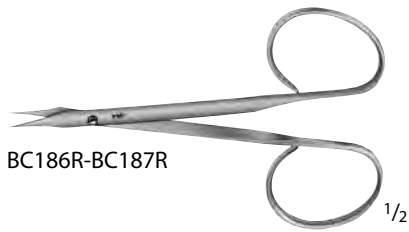

STEVENS Tenotomy Scissors, Delicate

Catalog Number	Tip	Blade	Handle	Length (in.)
BC186R	S/S	STR	RIBBON	4
BC187R	S/S	CVD	RIBBON	4
OK366R	B/B	CVD	RIBBON	4 1/4

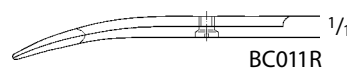
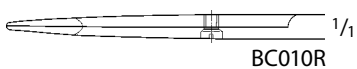
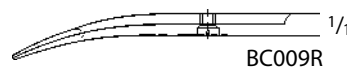
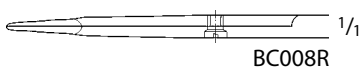
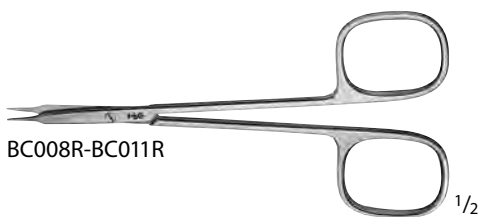
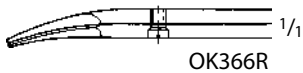
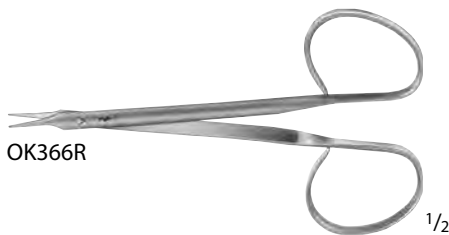

STEVENS Tenotomy Scissors, Delicate

Catalog Number	Tip	Blade	Handle	Length (in.)
BC008R	S/S	STR	SQUARE	4 1/2
BC010R	B/B	STR	SQUARE	4 1/2
BC009R	S/S	CVD	SQUARE	4 1/2
BC011R	B/B	CVD	SQUARE	4 1/2

STEVENS Tenotomy Scissors

Catalog Number	Tip	Blade	Handle	Length (in.)
BC170R	S/S	STR	ROUND	4 1/4
BC172R	B/B	STR	ROUND	4 1/4
BC194R	B/B	STR	ROUND	5
MA467R	B/B	STR	ROUND	5 3/4
BC171R	S/S	CVD	ROUND	4 1/4
BC173R	B/B	CVD	ROUND	4 1/4
BC195R	B/B	CVD	ROUND	5
MA466R	B/B	CVD	ROUND	5 3/4



BC170R-MA467R

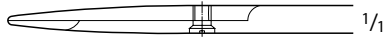

BC170R

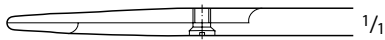

BC172R

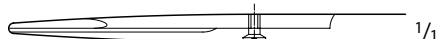

BC194R



MA467R



BC171R-MA466R

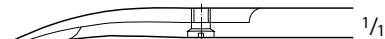

BC171R

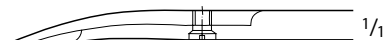

BC173R

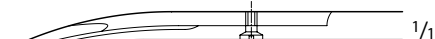

BC195R

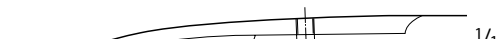

MA466R

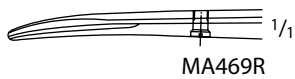
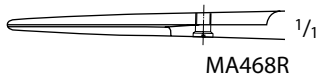
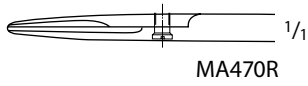

STEVENS Tenotomy Scissors

Catalog Number	Tip	Blade	Handle	Weight	Length (in.)
MA470R	B/B	STR	RIBBON	LIGHT	3 3/4
MA468R	B/B	STR	RIBBON	HEAVY	3 7/8
MA469R	B/B	CVD	RIBBON	HEAVY	3 3/4

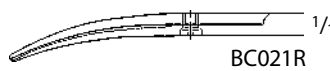
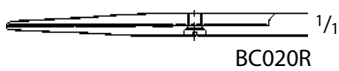
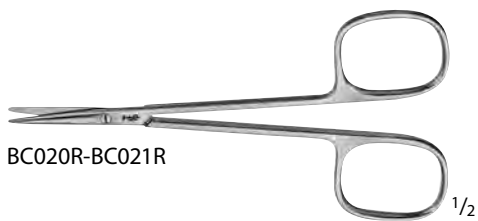

Strabismus Scissors, Delicate

Catalog Number	Tip	Blade	Handle	Length (in.)
BC020R	B/B	STR	SQUARE	4 1/2
BC021R	B/B	CVD	SQUARE	4 1/2

DUROTIP Tungsten Carbide Scissors

- Excellent cutting accuracy
- Long working life
- Gold-plated rings

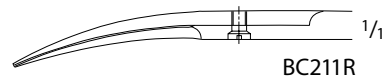
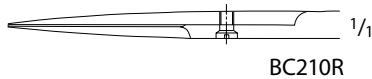
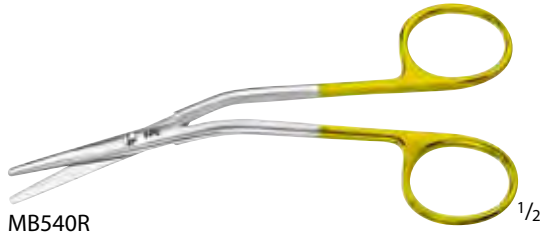

Wavecut

Wavecut scissors have one serrated cutting edge to prevent tissue from slipping.

The W after the catalog number indicates the scissors are the wavecut style, e.g. BC211W.

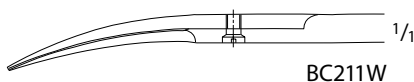
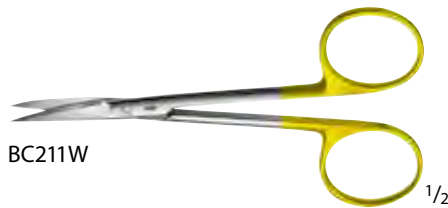

DUROTIP TC FOMON Dorsal Scissors

Catalog Number	Tip	Blade Angle	Length (in.)
MB540R	B/B	30°	5 1/4

DUROTIP TC Iris Scissors, Delicate

Catalog Number	Tip	Blade	Length (in.)
BC210R	S/S	STR	4 1/4
BC211R	S/S	CVD	4 1/4

DUROTIP TC Iris Scissors, Wavecut

Catalog Number	Tip	Blade	Length (in.)
BC211W	S/S	CVD	4 1/4

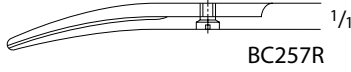
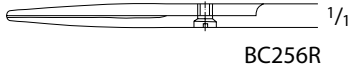
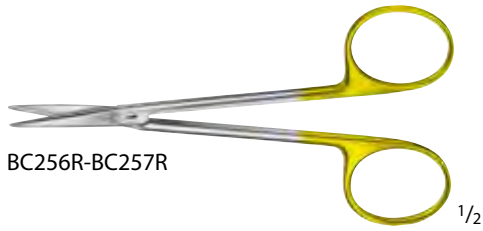

DUROTIP TC Strabismus Scissors,
 Delicate

Catalog Number	Tip	Blade	Length (in.)
BC256R	B/B	STR	4 1/2
BC257R	B/B	CVD	4 1/2



DUROTIP TC GOLDMAN-FOX
 Tenotomy Scissors, Delicate

Catalog Number	Tip	Blade	Length (in.)
DO250R	S/S	CVD, 1/SERR	5 1/8

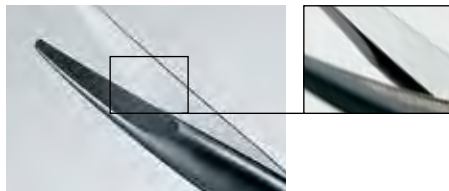

Microtome Edge

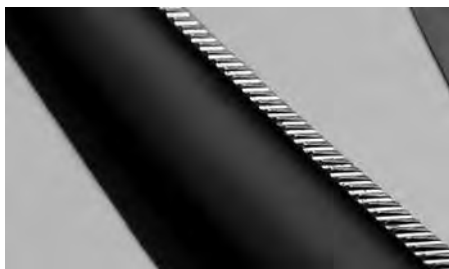

Wavecut

Noir Supreme Cut Scissors

- **Noir**
 The combination of the renowned Tungsten Carbide technology with the Noir coating results in an extremely high surface hardness and therefore high wear resistance in daily hospital use.
- **Microtome edge**
 The extremely sharp cutting edge of the scissors blade facilitates gentle cutting of tissue with minimal use of force.
- **Wavecut** helps prevent tissue from slipping out during the cutting process.
- The WB after the catalog number indicates the Noir scissors are the wavecut style, e.g. BC211WB.



Noir Baby METZENBAUM Dissecting Scissors

Catalog Number	Tip	Blade	Length (in.)
BC259B	B/B	CVD	5 3/4
BC259WB	B/B	CVD	5 3/4



Noir Strabismus Dissecting Scissors

Catalog Number	Tip	Blade	Length (in.)
BC257B	B/B	CVD	4 1/2
BC257WB	B/B	CVD	4 1/2



BC904R, BC906R



BC904R

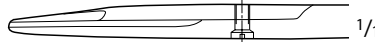

BC906R



BC905R, BC907R



BC905R

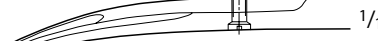

BC907R



BC939R



BC939R

STEVENS SuperCut Scissors

Catalog Number	Tip	Tip Size (mm)	Blade	Length (in.)
BC904R	B/B	12	STR	4 1/8
BC906R	B/B	13	STR	4 1/4
BC905R	B/B	12	CVD	4 1/8
BC907R	B/B	13	CVD	4 1/4

FOMON SuperCut Scissors

Catalog Number	Tip	Blade	Length (in.)
BC939R	B/B	CVD	4 1/2



Septum Needle W/ Luer Lock, Attachment

Catalog Number	Tip Size (mm)	Length (in.)
SF812R	DIAM. 0.8	3 1/2

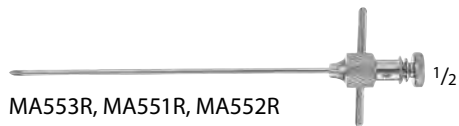

Antrum Trocar Needle

Catalog Number	Tip	Size	Length (in.)
MA553R	BEVELED STYLET	14 GA	4 1/4
MA551R	BEVELED STYLET	16 GA	4 1/4
MA552R	BEVELED STYLET	18 GA	4 1/4



Septum Needle

Catalog Number	Tip	Size	Length (in.)
MA601R	ANG	22	5 3/8



COAKLEY Antrum Trocar, with Irrigation Extension

Catalog Number	Length (in.)
MA554R	6 1/4





Sinoscopy Trocar and Cannula

Catalog Number	Tip Size (mm)	Length (in.)
MA597R	4	6 1/2
MA598R	5	6 1/2



OCHSNER Trocar

Catalog Number	Tip Size (FR)	Length (in.)
MG100R	10	6
MG101R	12	6
MG102R	14	6
MG103R	16	6
MG104R	18	6
MG105R	20	6
MG106R	22	6
MG107R	24	6
MG108R	26	6
MG109R	27	6
MG110R	28	6

BROWN Needle Holder, Heavy

Catalog Number	Tip Size (mm)	Jaw	Length (in.)
MA362R	13	SERR	5 1/4



MA362R

1/2



MA362R

1/1

SOFFERMAN Needle Holder

Catalog Number	Tip Size (mm)	Jaw	Working Length (in.)
MA627R	5	STR, SERR	3 5/8



MA627R

1/2



MA627R

1/1

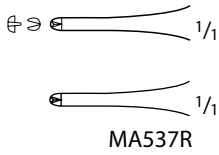

CALLISON-ADSON Tissue Forceps,
 W/ Platform

Catalog Number	Teeth	Length (in.)
MA537R	1 x 2	5



LUCAE Bayonet Forceps

Catalog Number	Tip	Teeth	Length (in.)
BD879R	SMOOTH	1 x 2	5 1/2
BD878R	SERR	-	5 1/2
MA331R	SERR	-	6 3/8
MA070R	DEL, SERR	-	5 3/4

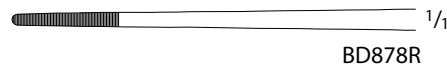
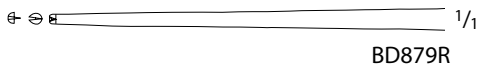

JANSEN Bayonet Forceps

Catalog Number	Tip	Length (in.)
BD880R	SERR	6 1/4
MB236	SERR	6 1/2

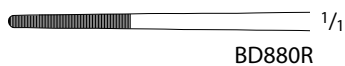

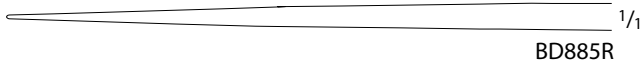
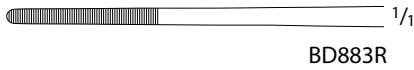

GRUENWALD Bayonet Forceps

Catalog Number	Tip	Length (in.)
BD883R	SERR	7 7/8

JACOBSON Forceps

Catalog Number	Tip	Length (in.)
MA615R	SMOOTH, SHARP	6 1/4

Bayonet Forceps

Catalog Number	Tip	Teeth	Length (in.)
BD885R	SMOOTH	-	7 1/4
BD886R	SMOOTH	1 x 2	7 7/8

BROWN-BAHNSON Bayonet Forceps

Catalog Number	Tip	Length (in.)
BD876R	SERR	6 1/8

ADSON Bayonet Forceps

Catalog Number	Tip	Length (in.)
BD870R	SERR	6 7/8



BD904R

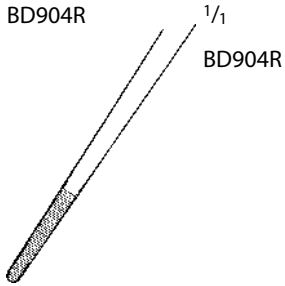

BD900R-BD902R

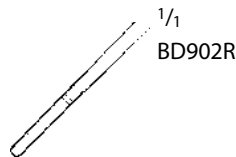
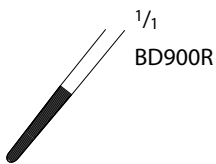

BD910R-BD911R

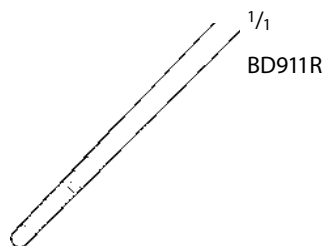
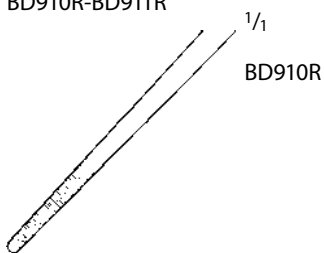

WILDE Forceps

Catalog Number	Tip	Length (in.)
BD904R	ANG/SERR	4 1/2

TROELTSCH Bayonet Forceps

Catalog Number	Tip	Length (in.)
BD900R	ANG/SERR	4
BD902R	ANG/SERR	4 1/2
BD910R	ANG/SERR	5 1/2
BD911R	ANG/SERR	6 3/4

HARTMANN Alligator Forceps

Catalog Number	Tip	Length (in.)
OK245R	ANG/SERR	7 1/2



OK245R

1/16
 OK245R

1/2

HARTMANN Nasal Dressing Forceps

Catalog Number	Length (in.)
OK242R	6 7/8
MA329R	7
OK243R	7 7/8
MA330R	8 1/2

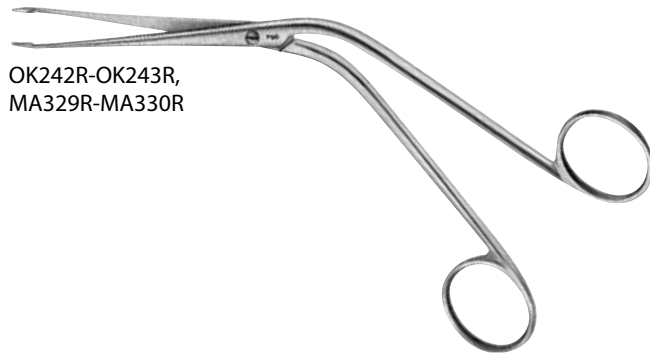

OK242R-OK243R,
 MA329R-MA330R

1/16
 OK242R

1/16
 MA329R

1/16
 OK243R

1/16
 MA330R

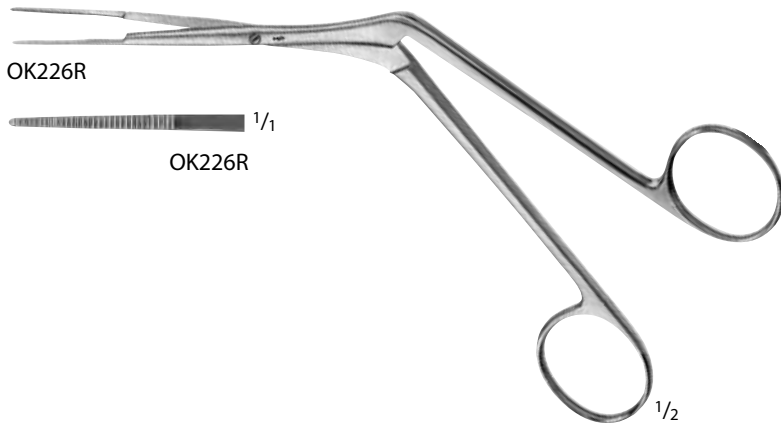

WEST Nasal Dressing Forceps

Catalog Number	Tip	Length (in.)
OK226R	SERR	7 7/8



COTTLE Columella Clamp, W/ Fixation
 Screw

Catalog Number	Length (in.)
OL010R	4



FERRIS-SMITH Fragment Forceps

Catalog Number	Tip Size (mm)	Working Length (in.)	Length (in.)
MA671R	8.2 x 6	4 1/4	7 7/8



OSTRUM Antrum Backbiting Punch
 Forceps

Catalog Number	Jaw Size (mm)	Jaw	Working Length (in.)	Length (in.)
MA555R	3 x 7	STR	4 1/4	7 3/4
MA556R	3 x 7	ANG-LEFT	4 1/4	7 3/4
MA557R	3 x 7	ANG-RIGHT	4 1/4	7 3/4



BRUENINGS Septum Forceps

Catalog Number	Size	Length (in.)
OK440R	SMALL	7 1/2
OK441R	MEDIUM	7 1/2
OK442R	LARGE	7 1/2
OK443R	X-LARGE	7 1/2

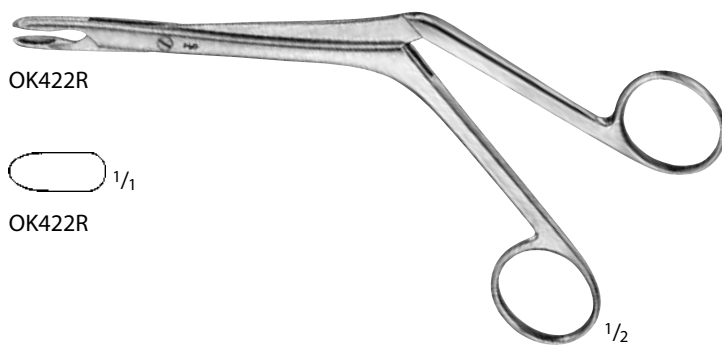

HEYMANN-KNIGHT Septum Forceps

Catalog Number	Jaw	Length (in.)
OK422R	OVAL	7 1/2

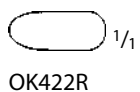

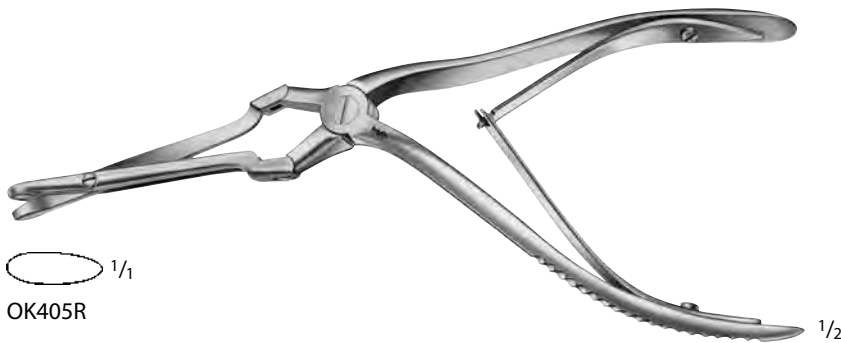

JANSEN-MIDDLETON Septum Forceps

Catalog Number	Jaw	Length (in.)
OK400R	SPOON	7 7/8
OK405R	THRU-CUT	8 1/4



GRUENWALD Nasal Forceps

Catalog Number	Tip Size (mm)	Tip Size (#)	Working Length (in.)	Length (in.)
MA325R	2.5 x 9	1	4	7 1/4
MA326R	3 x 10	2	4	7 1/4
MA327R	3.5 x 11	3	4	7 1/4
MA328R	3.5 x 10	3	4	7 1/4



OK612R-OK613R

GRUENWALD-HENKE Nasal Thru-Cut Rongeur

Catalog Number	Jaw	Working Length (in.)
OK612R	SMALL	4 3/4
OK613R	LARGE	4 3/4



1/16
OK612R

1/16
OK613R

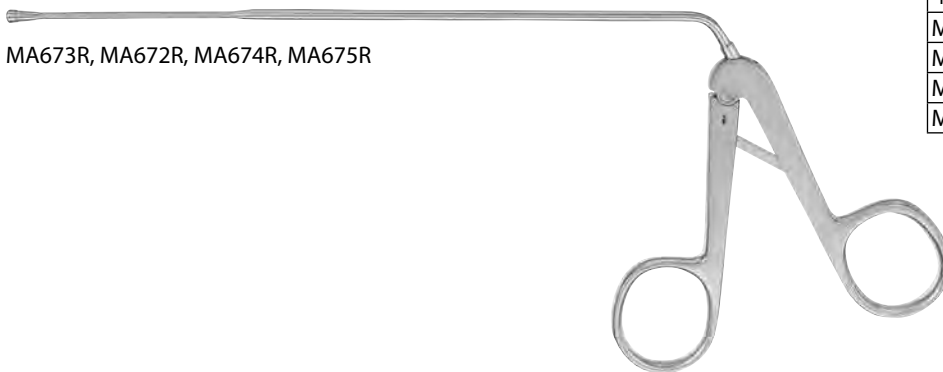

MA673R, MA672R, MA674R, MA675R

STAMMBERGER Circular Punch Forceps

Catalog Number	Tip	Tip Size (mm)	Working Length (in.)	Length (in.)
MA673R	STR	3.5	7 1/2	9 3/4
MA672R	STR	4.5	7 1/2	9 3/4
MA674R	70° UP	3.5	7 1/4	9 5/8
MA675R	70° UP	4.5	7 1/4	10 1/4



MA673R

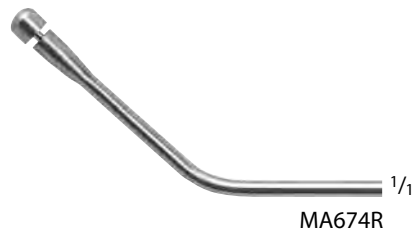

MA674R



MA672R

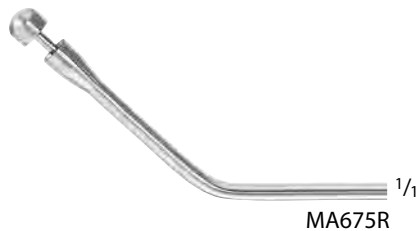

MA675R

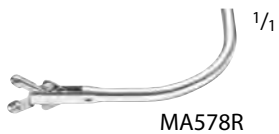
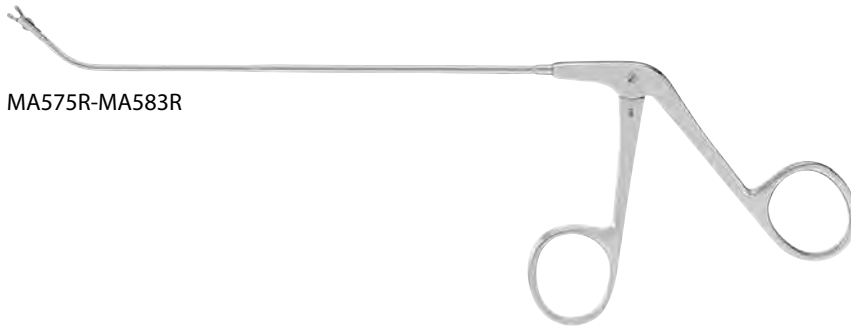

Giraffe Frontal Sinus Forceps

Catalog Number	Jaw	Cup Size (mm)	Working Length (in.)	Length (in.)
MA575R	ANG 45° VERTICAL CUTTING	2	5 1/2	8 7/8
MA576R	ANG 45° HORIZONTAL CUTTING	2	5 1/2	8 7/8
MA577R	ANG 90° VERTICAL CUTTING	2	5 1/8	8 3/8
MA578R	ANG 90° HORIZONTAL CUTTING	2	5 1/8	8 3/8
MA579R	ANG 45° VERTICAL CUTTING	3	5 1/2	8 7/8
MA581R	ANG 70° VERTICAL CUTTING DOUBLE ACTION	3	5 1/8	8 1/4
MA580R	ANG 90° HORIZONTAL CUTTING	3	5 1/2	8 7/8
MA582R	ANG 70° HORIZONTAL CUTTING DOUBLE ACTION	4	5 1/8	8 1/4
MA583R	ANG 100° HORIZONTAL CUTTING DOUBLE ACTION	4	4 5/8	8 1/4

Let Us know if you could not find what you are looking for

Giraffe Thru-Cut Sinus Forceps

Catalog Number	Jaw	Cup Size (mm)	Working Length (in.)
MA584R	ANG 70° VERTICAL CUTTING	3 x 6	4 3/4

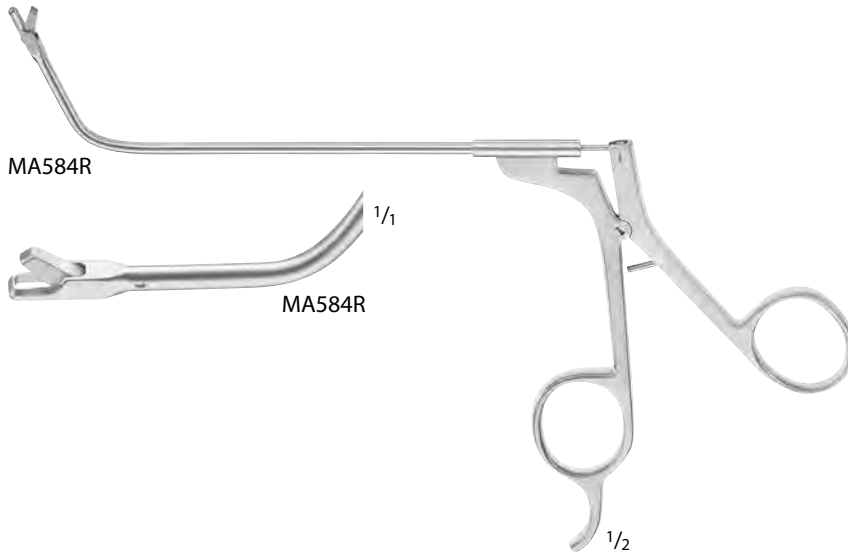

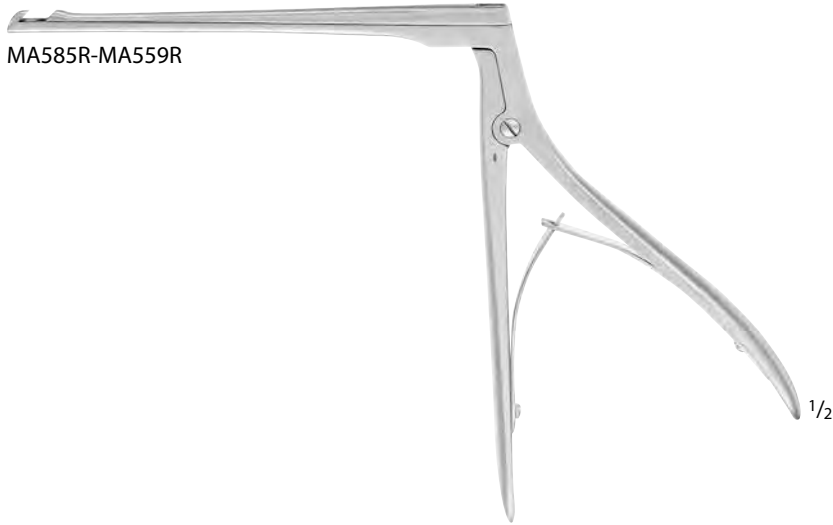

Antrum Punch Forceps

Catalog Number	Jaw	Tip	Cup Size (mm)	Working Length (in.)	Length (in.)
MA585R	ANG 45° BACK-WARD 3 MM	3	4 x 5	5 1/2	8 1/4
MA559R	45° FORWARD 3 MM	3	4 x 5	5 1/2	8 1/4

MCKENTY Sphenoid Punch Forceps, Rotatable

Catalog Number	Jaw	Working Length (in.)	Length (in.)
MA415R	1.5 x 4	5 3/4	7



OK711R-OK712R

KERRISON Nasal Rongeur

Catalog Number	Jaw Size (mm)	Jaw	Working Length (in.)
OK711R	4.0	90° UP	3 1/4
OK712R	5.0	90° UP	3 3/8



OK711R



OK712R



OK740R-OK742R

HAJEK-KOFLER Punch

Catalog Number	Jaw Size (mm)	Jaw	Working Length (in.)
OK740R	3.3	90° UP	5 1/2
OK741R	3.3	90° DOWN	5 1/2
OK742R	4.0	90° UP	5 1/2

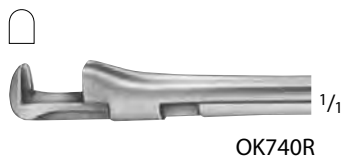

OK740R

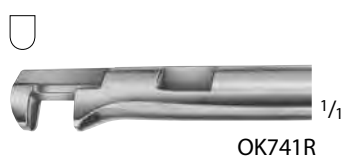

OK741R

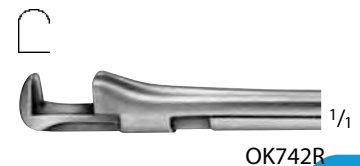

OK742R



HAJEK-KOFLER Rotatable Punch,
 (continued)

Catalog Number	Jaw Size (mm)	Jaw	Working Length (in.)
OK745R	4.0	90° UP	6 3/4

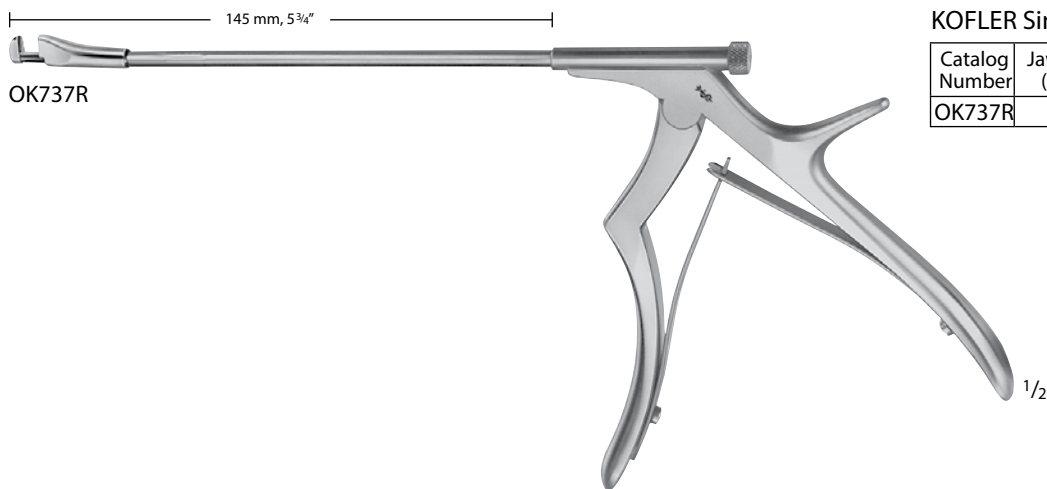
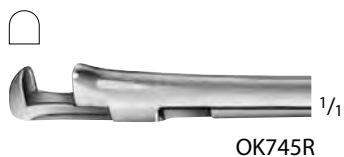

KOFLER Sinus Punch, Rotatable

Catalog Number	Jaw Size (mm)	Jaw	Working Length (in.)
OK737R	3.0	90° UP	5 3/4





MA340R-MA343R, OK525R-OK526R

TAKAHASHI Nasal Forceps

Catalog Number	Jaw Size (mm)	Jaw	Working Length (in.)
MA342R	2.5	STR	4 3/8
OK525R	3.0	STR	4 3/4
MA340R	3.0	STR	6 3/8
MA343R	4.0	STR	4 3/8
MA341R	4.0	STR	6 3/8
OK526R	3.0	45° UP	4 3/4

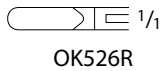

135 mm, 5 1/4"



FF799R-FF800R

LOVE-GRUENWALD Rongeur

Catalog Number	Jaw Size (mm)	Jaw	Working Length (in.)
FF799R	2 x 10	STR	5 1/4
FF800R	3 x 10	STR	5 1/4

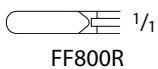
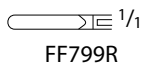

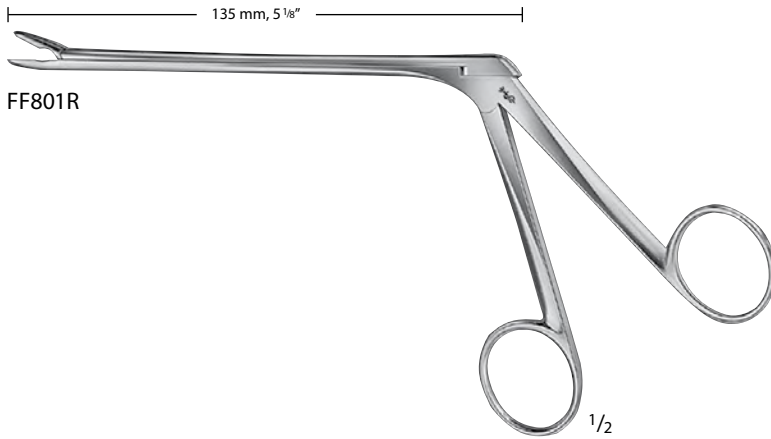

FF801R

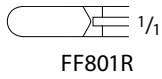

FF801R

SPURLING Rongeur

Catalog Number	Jaw Size (mm)	Jaw	Working Length (in.)
FF801R	4 x 10	STR	5 1/8

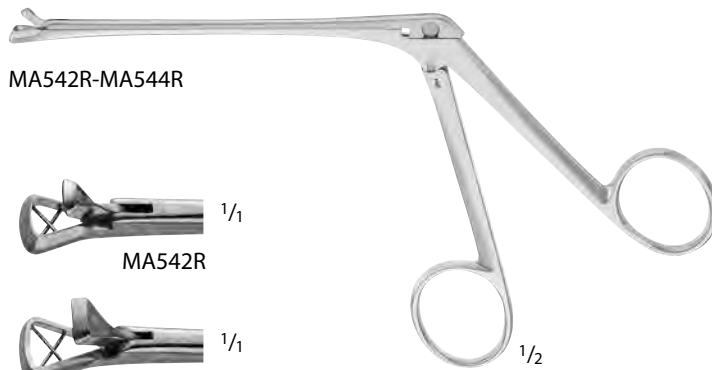

MA542R-MA544R



MA542R



MA543R



MA544R

MELTZER Adenoid Punch Forceps

Catalog Number	Tip Size (mm)	Size (#)	Jaw	Working Length (in.)	Length (in.)
MA542R	5 MM BOTTOM BASKET, 4 MM UPPER JAW	0	TRIANGULAR	4 1/2	7 1/4
MA543R	7 MM BOTTOM BASKET, 3 MM UPPER JAW	1	TRIANGULAR	4 1/2	7 1/4
MA544R	9 MM BOTTOM BASKET, 8 MM UPPER JAW	2	TRIANGULAR	4 1/2	7 1/4
MA541R	6 MM BOTTOM BASKET, 5 MM UPPER BITE	1	ROUND	4 1/2	7 1/4



MA541R



MA541R

Nasal Biopsy Forceps

Catalog Number	Cup Size (mm)	Tip	Working Length (in.)	Length (in.)
MA676R	2.5 x 4	STR	5	7
MA680R	2.5 x 5	70° UP	4	7
MA678R	2.5 x 6	70° UP	3 1/2	7 1/4

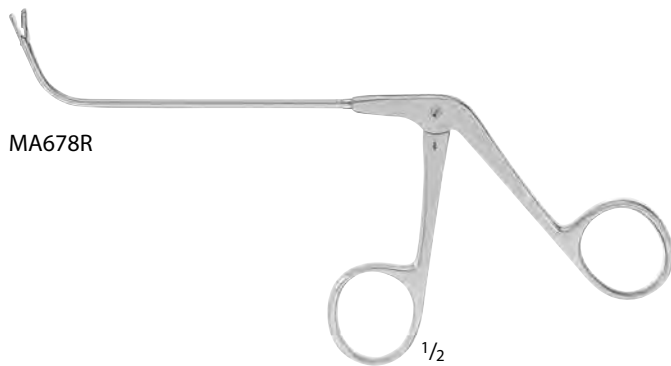
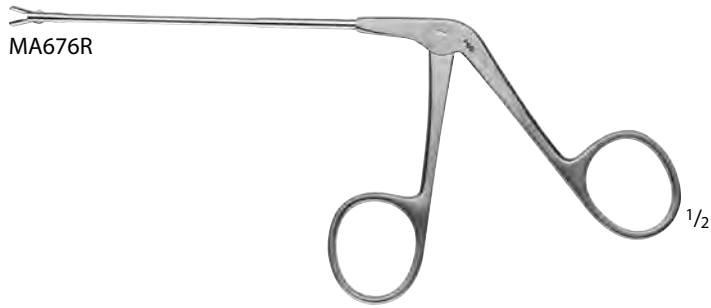



Nasal Suction Forceps

Catalog Number	Jaw Length (mm)	Tip	Tip Size (#)	Working Length (in.)	Length (in.)
MA697R	2.5	STR	00	4	7 1/4
MA699R	3.5	STR	0	4	7 1/4
MA701R	4.5	STR	1	4	7 1/4
MA698R	2.5	45° ANG-UP	00	4 3/4	7 1/4
MA700R	3.5	45° ANG-UP	0	4 1/2	7 3/4

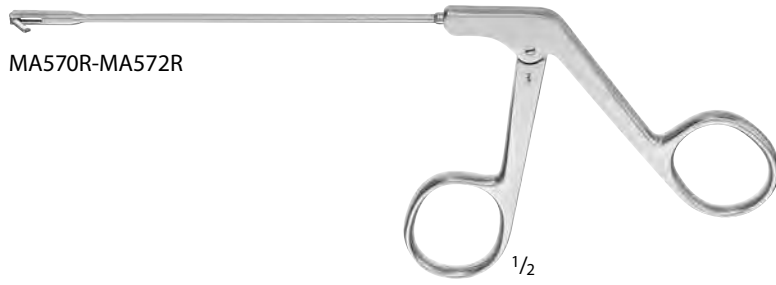

MA570R-MA572R



MA570R



MA571R



MA572R

Pediatric Ostrum Antrum Punch
 Forceps

Catalog Number	Jaw Size (mm)	Jaw	Working Length (in.)	Length (in.)
MA570R	1.5 x 4	STR BACK BITE	4 1/2	8
MA571R	1.5 x 4	RIGHT SIDE BITE	4 1/2	8
MA572R	1.5 x 4	LEFT SIDE BITE	4 1/2	8

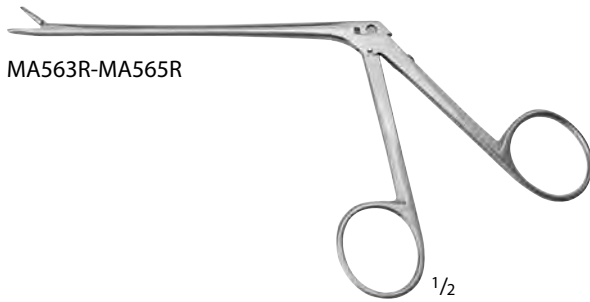

MA563R-MA565R

Ethmoid Forceps, Pediatric

Catalog Number	Jaw Size (mm)	Jaw	Working Length (in.)	Length (in.)
MA563R	3 x 5	STR	4	6 1/8
MA564R	3 x 5	ANG UP 45°	4	6 1/8
MA565R	3 x 5	ANG UP 90°	3 3/4	6 1/8

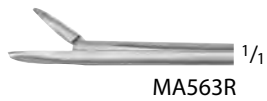

MA563R



MA564R



MA565R

Rotating Ostrum Antrum Punch Forceps, Backbiting

Catalog Number	Jaw Size (mm)	Size	Jaw	Working Length (in.)	Length (in.)
MA574R	1.5 x 4	Pediatric	ROTATING 360°	4 1/4	8 1/4
MA573R	3 x 7	Adult	ROTATING 360°	4 1/4	8 1/4

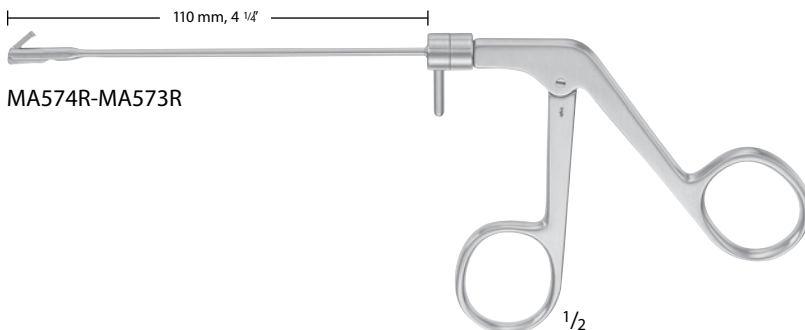

MA574R-MA573R



MA574R



MA573R

RONIS Adenoid Nasal Forceps

Catalog Number	Tip Size (mm)	Tip Size (#)	Jaw	Working Length (in.)	Length (in.)
MA545R	7 MM BASKET	1	TRIANGULAR	5 3/8	8 1/8
MA546R	8 MM BASKET	2	TRIANGULAR	5 3/8	8 1/8

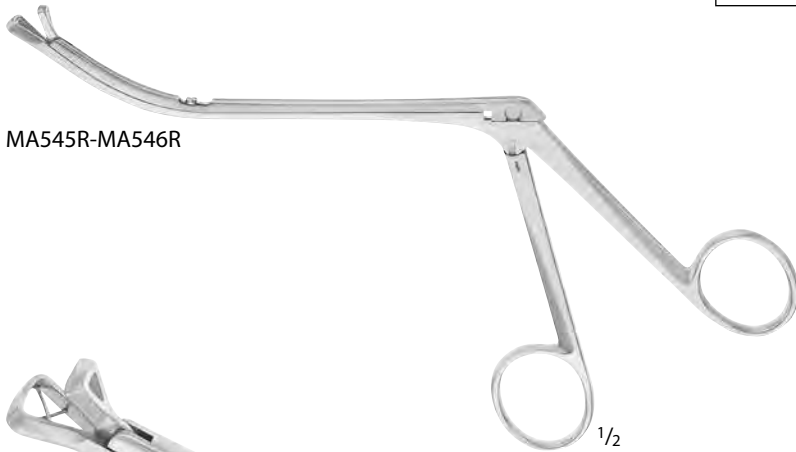

MA545R-MA546R

MA545R-MA546R



MA568R-MA569R

STAMMBERGER Sidecutting Antrum
 Punch Forceps

Catalog Number	Jaw	Length (in.)
MA568R	LEFT CUT	8 5/8
MA569R	RIGHT CUT	8 5/8



MA568R



MA569R



MA558R

Sinus Cup Forceps

Catalog Number	Cup Size (mm)	Working Length (in.)	Length (in.)
MA558R	3	4 1/2	7



MA558R



MA669R

COTTLE Biting Forceps

Catalog Number	Jaw Length (mm)	Jaw	Length (in.)
MA669R	30	ANG	7



MA669R



MA670R

ROWLAND Bone Cutting Forceps,
 Double Action

Catalog Number	Jaw Length (mm)	Length (in.)
MA670R	25	7 1/4

STAMM Bone Cutting Ronguer

Catalog Number	Length (in.)
FO604R	6



FO604R



FO604R

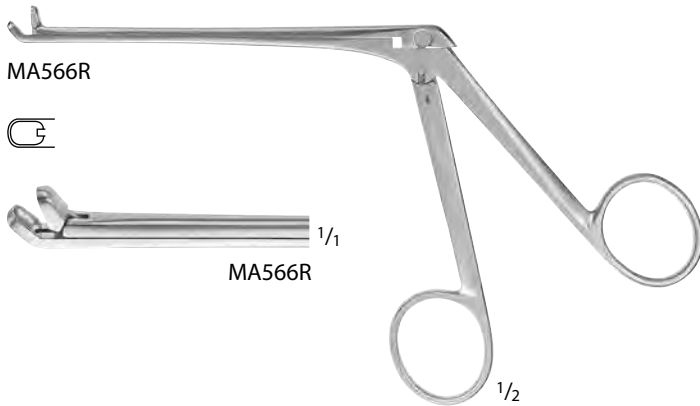

STUEMPEL-VOSS Nasal Forceps

Catalog Number	Cup (mm)	Tip	Working Length (in.)	Length (in.)
MA566R	3 x 5	ANG UP	4 1/4	6 7/8



WEIL Nasal Forceps

Catalog Number	Cup (mm)	Tip	Working Length (in.)	Length (in.)
MA344R	5 x 8	STR	4	7 1/8
MA345R	5 x 8	ANG UP	4	7 1/8



120 mm, 4 3/4"



OK505R-OK509R

WEIL-BLAKESLEY Nasal Forceps

Catalog Number	Jaw Size (mm)	Tip	Tip Size (#)	Working Length (in.)
OK505R	3.0	STR	0	4 3/4
MA320R	3.5	STR	0	4
OK506R	3.6	STR	0	4 3/4
MA321R	4	STR	1	4 1/2
OK507R	4.2	STR	1	4 3/4
OK508R	4.8	STR	2	4 3/4
MA322R	5	STR	2	4 1/2
OK509R	5.6	STR	3	4 3/4
OK520R	3.6	ANG 45° UP	0	4 1/2
MA323R	4	ANG 45° UP	1	4 1/8
OK521R	4.2	ANG 45° UP	1	4 1/2
OK522R	4.8	ANG 45° UP	2	4 1/2
MA324R	4	ANG 90° UP	1	4



110 mm, 4 1/4"

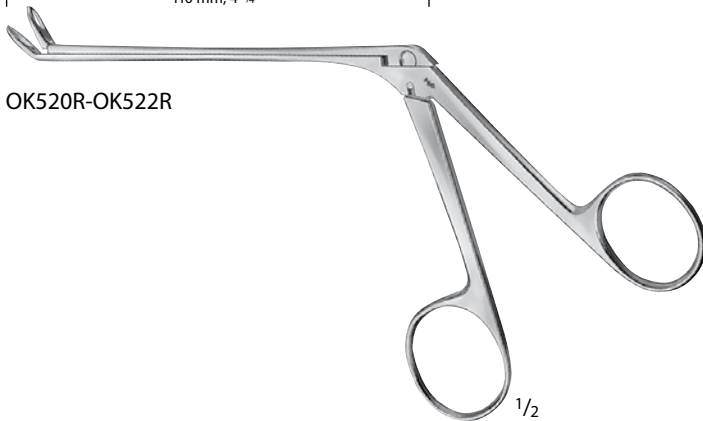

OK520R-OK522R

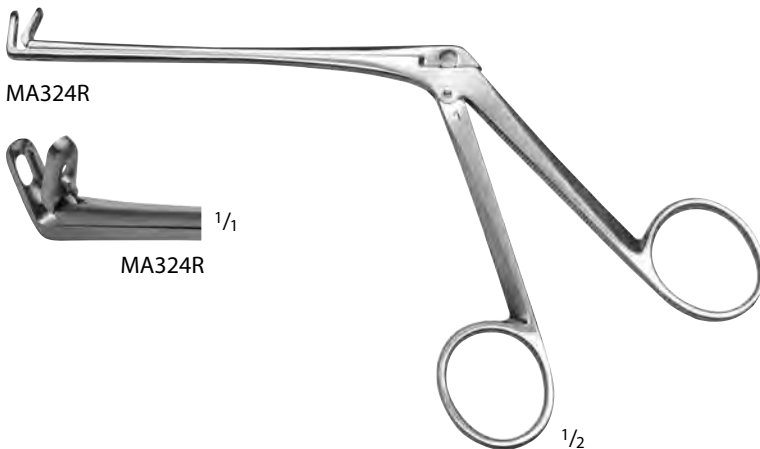

MA324R

MA324R

Let Us know if you could not find what you are looking for



BLAKESLEY Thru-Cut Forceps

Catalog Number	Size	Jaw Size (mm)	Tip	Jaw Size (#)	Working Length (in.)	Length (in.)
MA694R	PEDIATRIC	2.5	STR	00	4 1/4	7
MA695R	PEDIATRIC	2.5	ANG	00	4 1/4	7
MA684R	-	3.5	STR	0	4 1/2	7 3/4
MA686R	-	2.5	ANG UP	00	4 3/8	7 1/4

BLAKESLEY-WILDE Nasal Forceps

Catalog Number	Jaw Size (mm)	Tip	Working Length (in.)
OK544R	10 x 3.5	ANG 90° UP	4 1/4
OK545R	13.5 x 3.8	ANG 90° UP	4 1/4
OK546R	14.3 x 5	ANG 90° UP	4 1/4

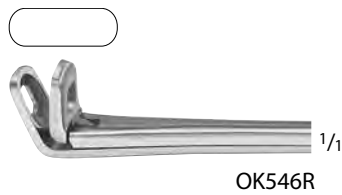
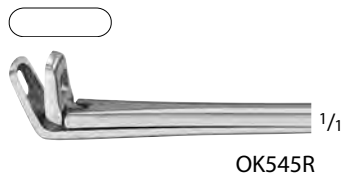
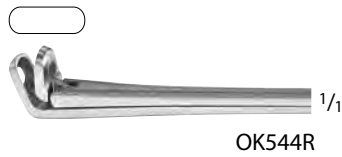
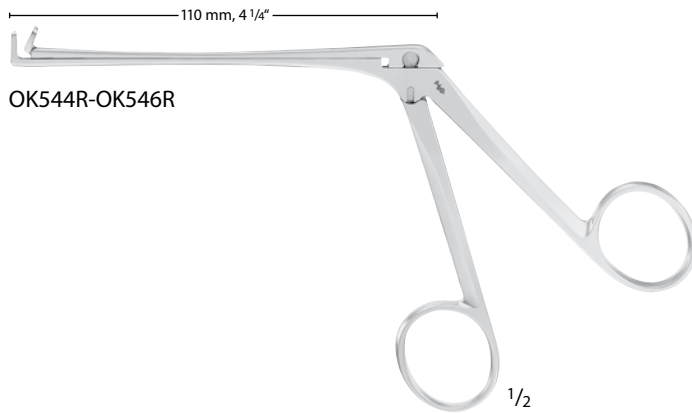

WILDE Ethmoid Nasal Forceps

Catalog Number	Jaw Size (mm)	Tip	Jaw Size (#)	Working Length (in.)
MA567R	3.5 x 12	ANG UP 45°	0	4 3/8

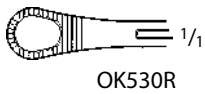

WATSON-WILLIAMS Ethmoid Forceps

Catalog Number	Jaw	Tip	Working Length (in.)
MA560R	3 MM THRU CUT JAWS W/ BASKET, ANG UP	ANG UP	5 3/8
OK530R	STR, SERR	STR	4 3/4



OK527R-OK531R

WATSON-WILLIAMS Ethmoid Forceps

Catalog Number	Jaw Size (mm)	Tip	Size	Working Length (in.)
OK527R	5.0	STR	SMALL	4 3/4
OK529R	7.0	STR	MEDIUM	4 3/4
OK531R	9.0	STR	LARGE	4 3/4

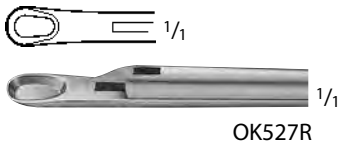

OK527R

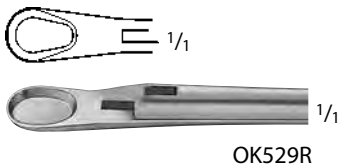

OK529R

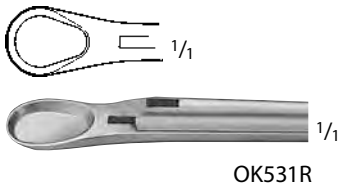

OK531R



WILDE Nasal Forceps

Catalog Number	Jaw Size (mm)	Tip	Working Length (in.)	Length (in.)
MA561R	5 x 10	STR	4 1/2	7 1/4
MA562R	5 x 10	ANG UP	4 1/2	7 1/4

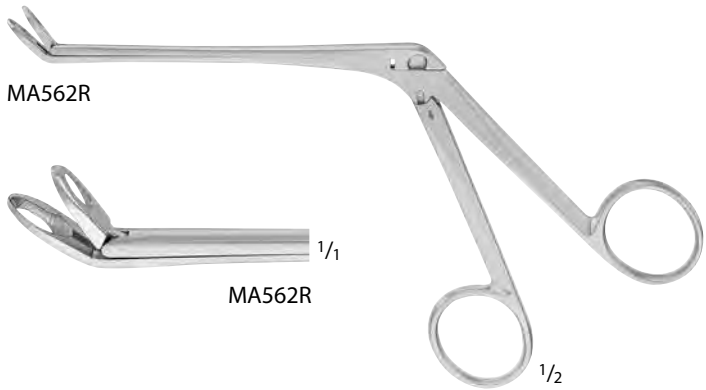

WILDE-Type Backbiter Forceps

Catalog Number	Jaw Size (mm)	Tip	Working Length (in.)	Length (in.)
MA688R	2	STR, ROTATING 360°	4 1/4	8 3/4
MA689R	2	CVD UP	3 1/8	6 7/8
MA690R	2	CVD DOWN	3 1/8	6 7/8

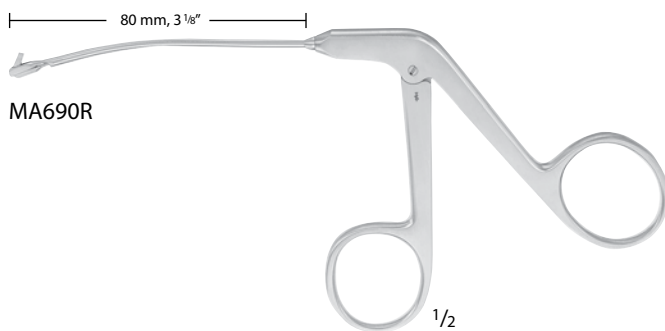
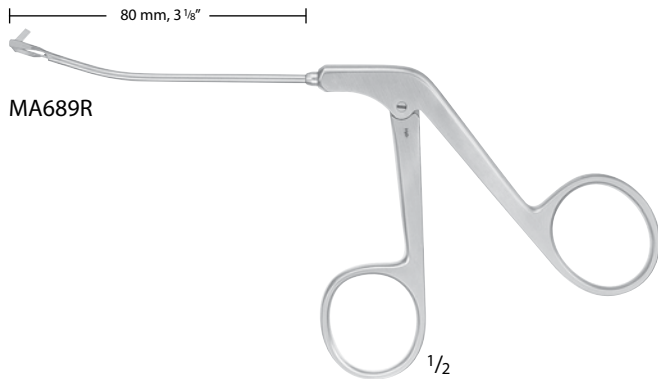
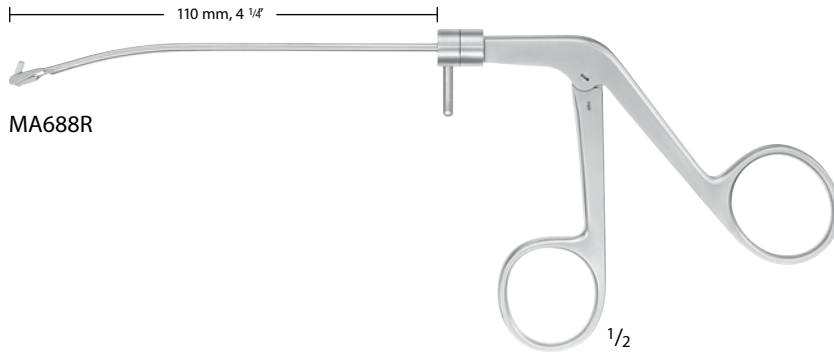



ASH Septum Forceps

Catalog Number	Tip	Length (in.)
OL470R	ANG	8 3/4



COTTLE-WALSHAM Septum Forceps

Catalog Number	Tip	Length (in.)
OL473R	STR	8 3/4



WALSHAM Septum Forceps

Catalog Number	Tip	Length (in.)
OL472R	LEFT	8 3/4
OL471R	RIGHT	8 3/4



OL474R



OL474R

Septum Morselizer Forceps,
 W/ Removable Guard

Catalog Number	Length (in.)
OL474R	7 7/8



OL460R

Bone and Cartilage Crusher, W/ Clamp

Catalog Number
OL460R

KRAUSE Nasal Polyp Snare, Knee-Shape

Catalog Number	Length (in.)
OK260R	9 3/4



OK260R

WILDE Nasal Polyp Snare

Catalog Number	Tip	Length (in.)
OK270R	BAYO	9 3/4



OK270R

Nasal Snare Wire

Catalog Number	Diameter (mm)	Packaging
OK293R	0.3	100/BOX

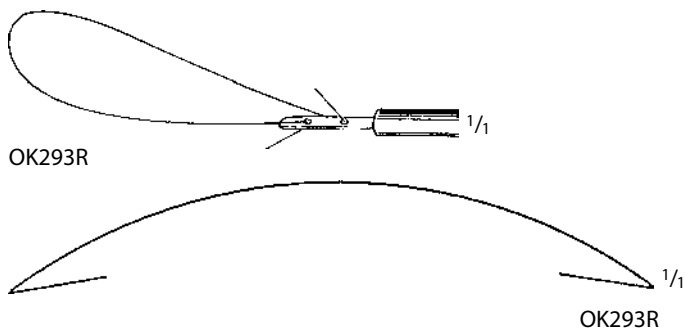

OK293R

OK293R



LANGE Fistul Hook

Catalog Number	Tip	Length (in.)
OL201R	BLUNT	9 1/4

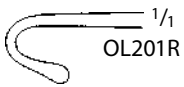

CONVERSE Skin Hooks

Catalog Number	Size	Length (in.)
MA178R	SMALL	7 1/8
MA179R	LARGE	7 1/8



CONVERSE Double Hook

Catalog Number	Blade Size (mm)	Length (in.)
OL207R	7 x 12 / 8 x 12	4 3/4



MILLARD Double Hook W/ Thimble Mount

Catalog Number	Length (in.)
MA186R	3 1/4





OK099R-MA422R

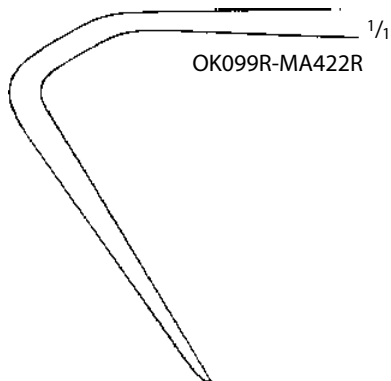

OK099R-MA422R

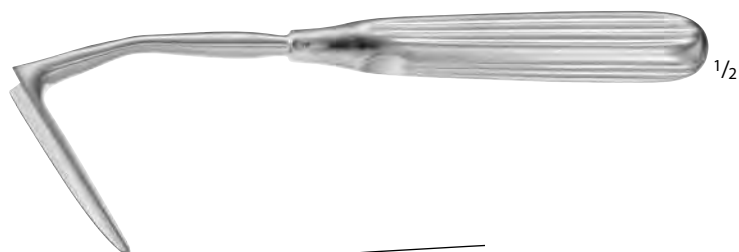

MA423R

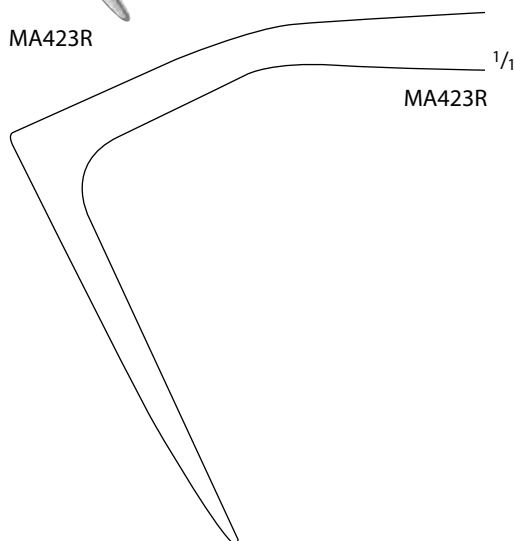

MA423R



MA424R

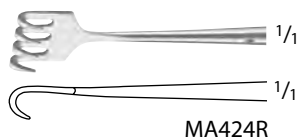

MA424R

AUFRICHT Nasal Retractor

Catalog Number	Blade Size (mm)	Length (in.)
OK099R	10 x 45	6 7/8
MA422R	10 x 45	7 3/8
MA423R	11 x 60	7 3/8

Blair Retractor

Catalog Number	Tip	Blade End	Tip Size (mm)	Length (in.)
MA424R	SHARP	4 PRONGS	7	5 1/4



MA425R



MA426R



MA427R

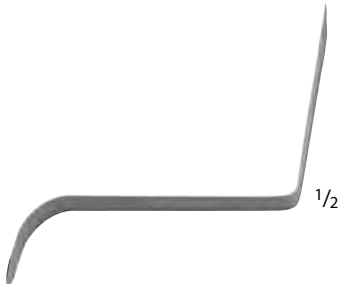

MA428R



MB107R

CONVERSE Nasal Retractor

Catalog Number	Blade Size (mm)	Length (in.)
MA425R	9 x 18	3 1/4
MA426R	12 x 21	3 1/4
MA427R	12 x 38	3 1/4
MA428R	12 x 53	3 1/4
MB107R	44 x 11	4 1/2



MA430R



MA430R



OL214R



1/1



OL214R



OL203R-OL204R



OL203R



OL204R

COTTLE Nasal Retractor

Catalog Number	Tip	Blade End	Tip Size (mm)	Length (in.)
MA430R	BLUNT	4 PRONGS	10	5 1/8

COTTLE Nasal Retractor, Double Ended

Catalog Number	Blade Size (mm)	Tip	Length (in.)
OL214R	12 x 5 / 4 x 4.5	BALL END/ BLUNT	7 7/8

COTTLE Retractor

Catalog Number	Tip	Length (in.)
OL203R	BLUNT/RIGHT SHARP	5 3/4
OL204R	LEFT SHARP/BLUNT	5 3/4



OL212R



OL212R



OL211R



OL211R



OL202R

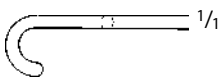

OL202R



MA431R



MA431R



MG473R

COTTLE Alar (MASING) Retractor

Catalog Number	Blade Size (mm)	Length (in.)
OL211R	6 x 12	5 1/2
OL212R	10 x 12	5 1/2

FOMON Retractor

Catalog Number	Tip Size (mm)	Tip	Blade End	Length (in.)
OL202R	12	BLUNT	2 PRONGS	5 3/4
MA431R	13	BALL END	2 PRONGS	6 1/4

GILLIES Bone and Zygoma Hook

Catalog Number	Tip Size (mm)	Length (in.)
MG473R	9	7 1/4

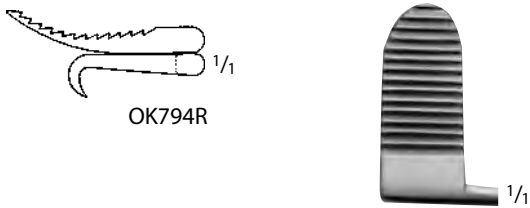
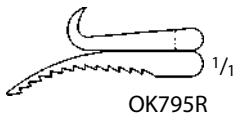

PERKINS Antrum Retractor

Catalog Number	Right Blade	Left Blade	Length (in.)
OK795R	3 PRONGS	SOLID	5
OK794R	SOLID	3 PRONGS	5

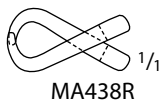

Baby WEITLANER Retractor

Catalog Number	Tip	Blade End	Length (in.)
MA438R	BLUNT	3 x 3 PRONGS	4 1/4

WULLSTEIN Retractor

Catalog Number	Tip	Blade End	Length (in.)
MB054R	BLUNT	3 x 3 PRONGS	4 1/4



MB054R

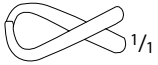

MB054R

JANSEN Retractor

Catalog Number	Tip	Blade End	Length (in.)
BV030R	SHARP	3 x 3 PRONGS	4
BV032R	BLUNT	3 x 3 PRONGS	4
BV033R	BLUNT	3 x 4 PRONGS	4



BV030R



BV030R



BV032R



BV032R



BV033R

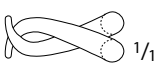

BV033R



OL477R

BOIES Nasal Fracture Elevator

Catalog Number	Tip	Length (in.)
OL477R	BLUNT	7



OL479R

GOLDMANN Septum Displacer

Catalog Number	Tip	Length (in.)
OL479R	STR	7 7/8



MB190R

CUSHING Elevator, Narrow

Catalog Number	Tip Size (mm)	Tip	Length (in.)
MB190R	8	SHARP	7 3/4



1/1



1/1

MB190R



MA147R

LEMPERT Elevator

Catalog Number	Tip Size (mm)	Blade	Length (in.)
MA147R	7	CVD	7 1/4



1/1



1/1

MA147R

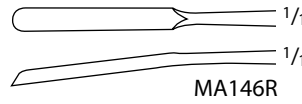
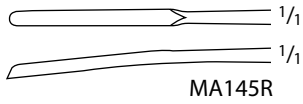

LEMPERT Elevator

Catalog Number	Tip	Tip Size (mm)	Length (in.)
MA145R	SLIGHT CVD	2	6 3/4
MA146R	SLIGHT CVD	3	6 3/4
OG163R	STR	3	7 1/2
OG164R	BROAD, SLIGHT CVD	6	7 1/4

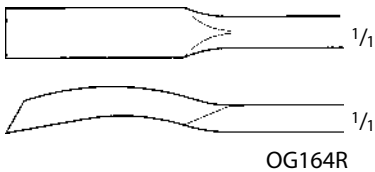

KLEINERT-KUTZ Elevator and Dissector, Double Ended

Catalog Number	Tip Size (mm)	Length (in.)
MA290R	2/4	7

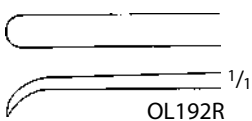

MCKENTY Periosteal Elevator

Catalog Number	Tip	Tip Size (mm)	Length (in.)
OL192R	CVD, SHARP	4.0	6



Ball End Elevator, Double Ended

Catalog Number	Blade Shape	Length (in.)
MA139R	ANG	7 1/2



COTTLE Elevator, Double Ended

Catalog Number	Blade	Length (in.)
OL155R	-	7 7/8
OL152R	GRADUATED	7 7/8

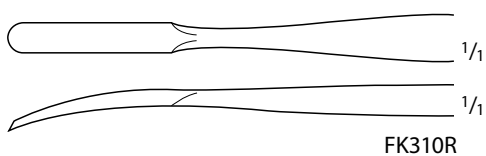

COTTLE Periosteal Elevator

Catalog Number	Tip	Width (mm)	Length (in.)
FK310R	SLIGHTLY CVD	4	7
OL157R	CVD, SHARP	8	7 3/4

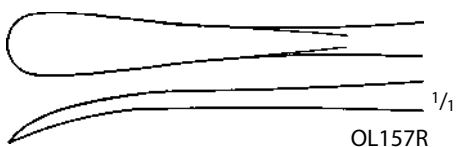



OL162R

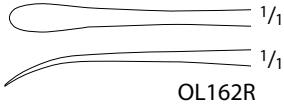

OL162R



OL163R

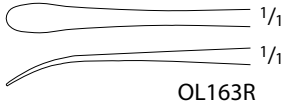

OL163R



OL165R

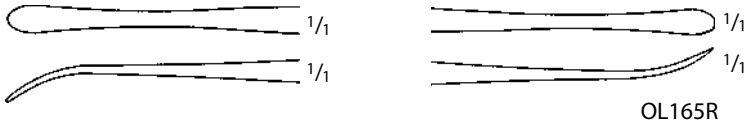

OL165R



MA643R-MA141R

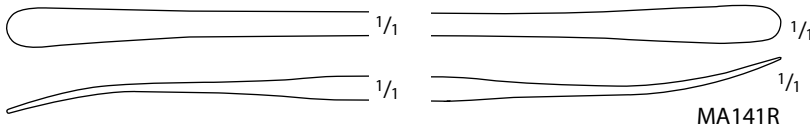

MA141R

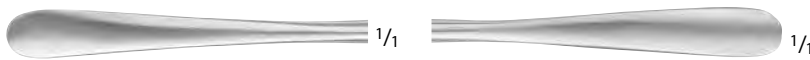

MA643R



OL166R

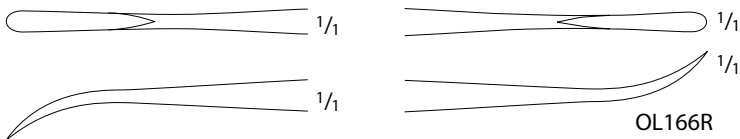

OL166R

FREER Elevator

Catalog Number	Tip	Tip Size (mm)	Length (in.)
OL162R	SINGLE ENDED SHARP	4	7 1/2
OL163R	SINGLE ENDED BLUNT	4	7 1/2
OL165R	SHARP/BLUNT	4 / 4	7 1/4
MA643R	SHARP/BLUNT	4.5 / 4.5	7 1/2
MA141R	SHARP/BLUNT	6.5	7 1/2

FREER-YASARGIL Elevator

Catalog Number	Tip	Length (in.)
OL166R	SHARP/SHARP	7 1/4



OL198R

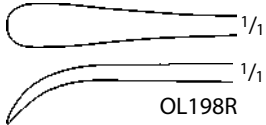

OL198R



MB297R



MB297R



OL153R



OL153R



OL151R



OL151R



MB313R



MB313R



MB312R



MB312R

SEWALL Antrum Elevator

Catalog Number	Tip	Tip Size (mm)	Length (in.)
OL198R	BLUNT	5.9	7 7/8

HAJEK-BALLENGER Septum Elevator and Dissector, Double Ended

Catalog Number	Tip	Length (in.)
MB297R	SHARP/BLUNT	7 1/2

COTTLE (MASING) Elevator, Graduated

Catalog Number	Blade	Length (in.)
OL153R	DBL ENDED	7 7/8

PENNINGTON Elevator

Catalog Number	Tip	Length (in.)
OL151R	SHARP/SHARP	8 1/4

PIERCE Submucous Dissector

Catalog Number	Length (in.)
MB313R	7 1/2

ROGERS Submucous Dissector

Catalog Number	Length (in.)
MB312R	8 3/4



MA144R

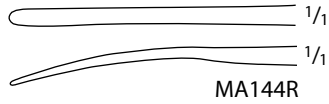

HENNER Elevator, Double Ended

Catalog Number	Tip Size (mm)	Length (in.)
MA144R	2/2	8 1/2



OL171R



HOWARTH Elevator, Double Ended

Catalog Number	Tip	Length (in.)
OL171R	SHARP/BLUNT	8 1/2



OL170R

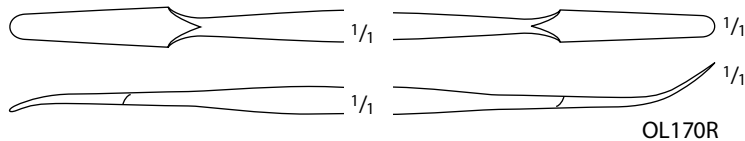

KILLIAN Elevator, Double Ended

Catalog Number	Tip	Length (in.)
OL170R	SHARP/BLUNT	7 1/4



MG374R

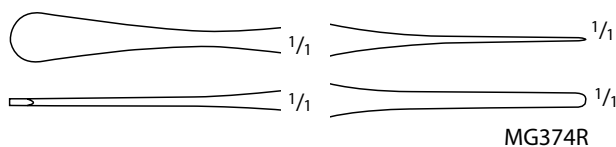

Spatula and Packer, Double Ended

Catalog Number	Length (in.)
MG374R	5 3/4



OL160R

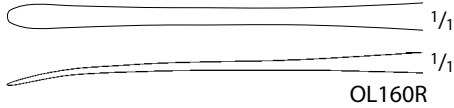

OL160R



OM307, OM309R, OM308R

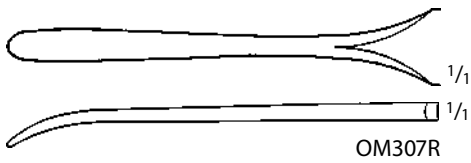

OM307R

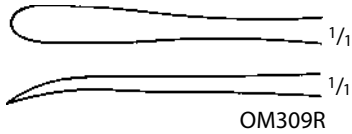

OM309R

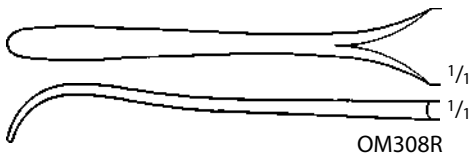

OM308R



MA143R

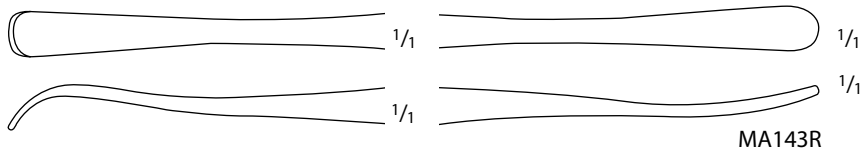

MA143R

HALLE Elevator

Catalog Number	Tip	Tip Size (mm)	Length (in.)
OL160R	BLUNT	3.3	7

KOENIG Elevator

Catalog Number	Tip	Tip Size (mm)	Length (in.)
OM307R	SLIGHTLY CVD	4.5	6 1/8
OM309R	SLIGHTLY CVD	4.5	6 1/8
OM308R	STRONGLY CVD	4.5	6 1/8

OBWEGESER-FREER Elevator

Catalog Number	Tip	Tip Size (mm)	Blade Shape	Length (in.)
MA143R	BLUNT	6	DBL ENDED	8 1/2



OK085R

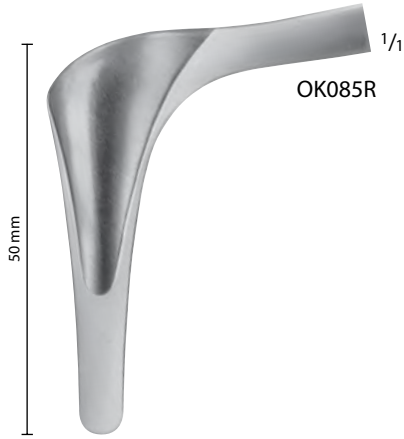

OK089R-OK090R

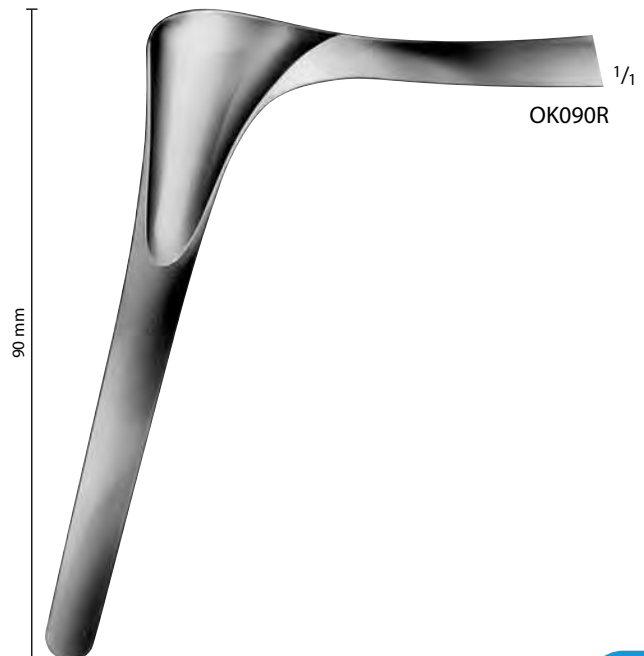
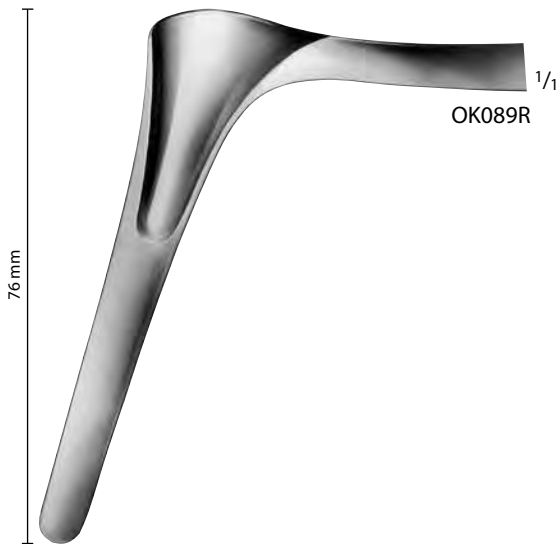

COTTLE Septum Speculum

Catalog Number	Blade Size (mm)	Blade Shape	W/ Set Screw	Length (in.)
OK085R	50 x 6	TAPERED	NO	5 1/4
OK089R	76 x 7	THIN	YES	5 1/4
OK090R	90 x 7	THIN	YES	5 1/4



OK105R-OK108R

COTTLE Nasal Speculum

Catalog Number	Blade Size (mm)	Blade Shape	Size (#)	Length (in.)
OK105R	20	Xtra Thin	1	5 1/4
OK106R	38	Xtra Thin	2	5 1/4
OK107R	41	Xtra Thin	3	5 1/4
OK108R	60	Xtra Thin	4	5 1/4

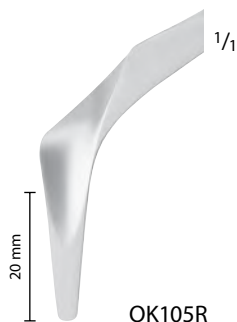

OK105R



OK106R



OK107R

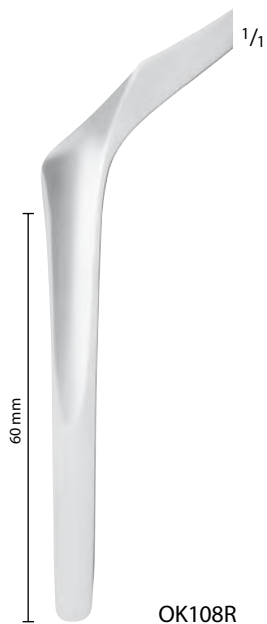

OK108R



MA346R

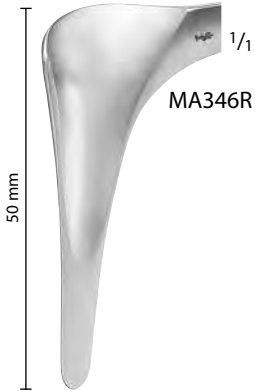

OK081R-OK084R

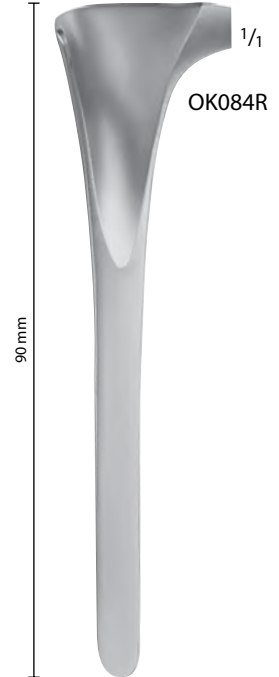
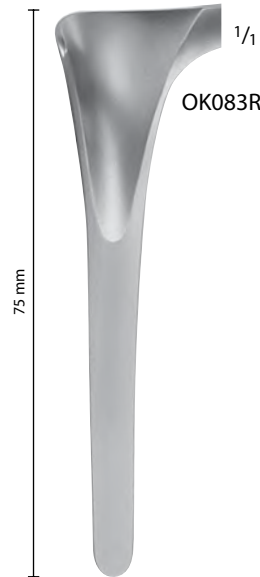
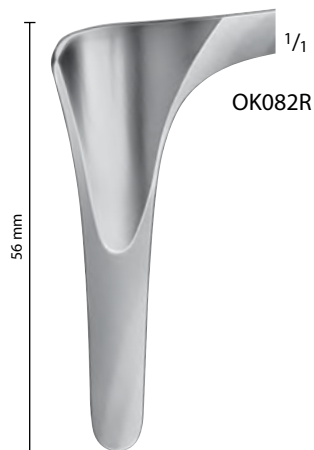
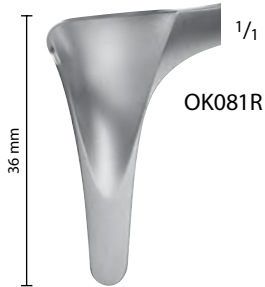

COTTLE Septum Speculum (continued)

Catalog Number	Blade Size (mm)	Blade Shape	Length (in.)
MA346R	50	THIN	5 5/8

KILLIAN Septum Speculum, Aseptic

Catalog Number	Blade Size (mm)	Length (in.)
OK081R	36 x 7	5 1/2
OK082R	56 x 7	5 1/2
OK083R	75 x 7	5 1/2
OK084R	90 x 7	5 1/2



OK091R-OK094R

KILLIAN Septum Speculum W/ Screw Joint

Catalog Number	Blade Size (mm)	Length (in.)
OK091R	36 x 7	5 3/4
OK092R	56 x 7	5 3/4
OK093R	75 x 7	5 3/4
OK094R	90 x 7	5 3/4

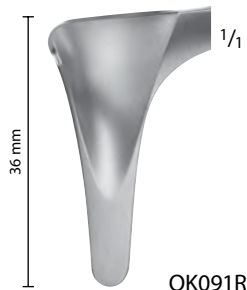

OK091R

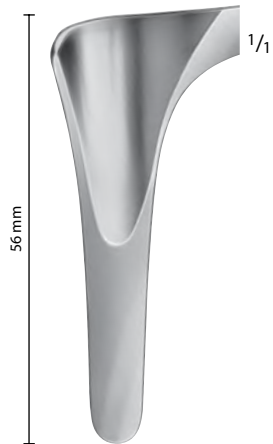

OK092R

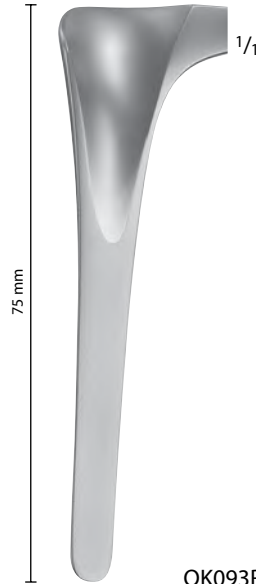

OK093R

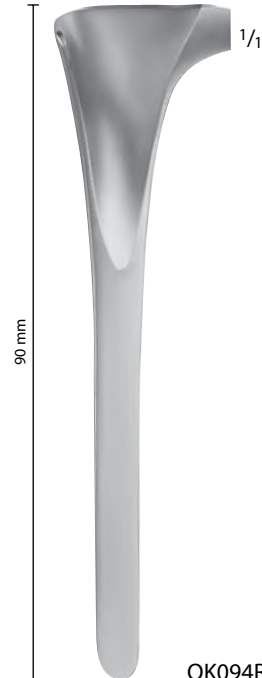

OK094R

VIENNA Nasal Speculum

Catalog Number	Blade Size	Length (in.)
OK060R	SMALL	5 1/2
OK061R	MEDIUM	5 1/2
OK062R	LARGE	5 1/2

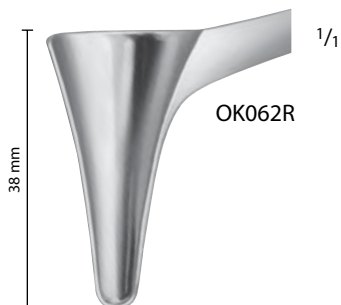
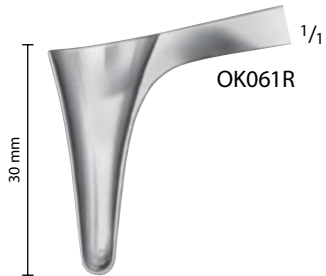

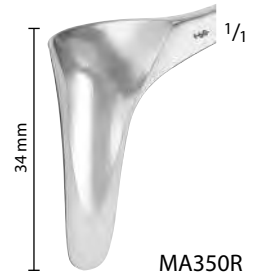
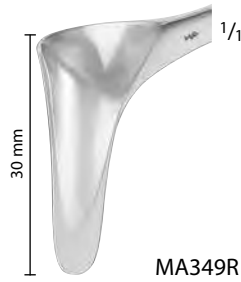
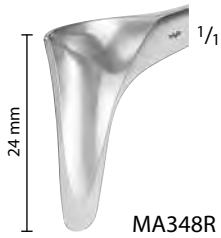

VIENNA Nasal Speculum (continued)

Catalog Number	Blade Size (mm)	Tip Size (mm)	Length (in.)
MA348R	24	1	5 1/4
MA349R	30	3	5 1/4
MA350R	34	4	5 1/4

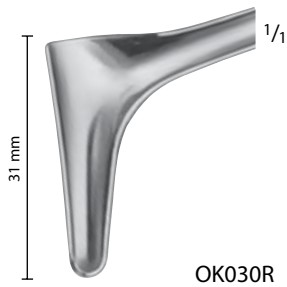

HARTMANN Nasal Speculum

Catalog Number	Blade Size	Length (in.)
OK030R	LIGHT	5 3/4
OK041R	SMALL	6 1/4
OK042R	MEDIUM	6 1/4
OK043R	LARGE	6 1/4

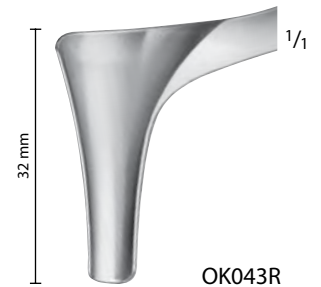
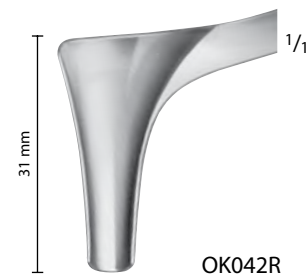
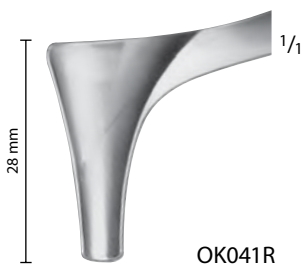

Let Us know if you could not find what you are looking for



HARTMANN-HALLE Nasal Speculum
 W/ Screw Joint

Catalog Number	Blade Size	Length (in.)
OK047R	SMALL	6 1/8
OK048R	MEDIUM	6 1/8
OK049R	LARGE	6 1/8

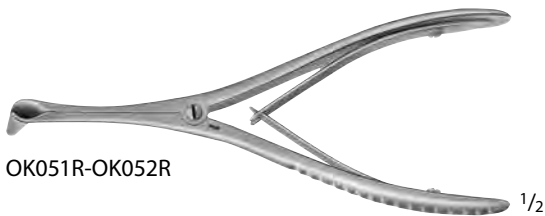
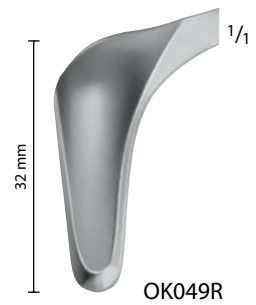
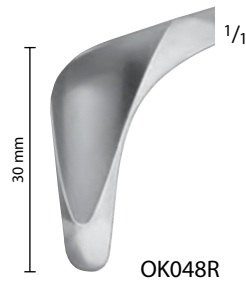
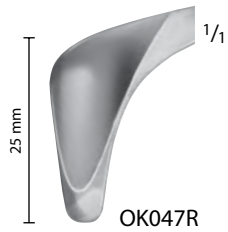

TIECK-HALLE Nasal Speculum W/
 Screw Joint, Pediatric

Catalog Number	Blade Size	Length (in.)
OK051R	SMALL	5 1/4
OK052R	LARGE	5 1/4





OK053R

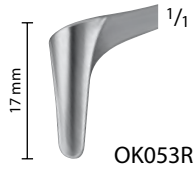

OK053R



OK058R

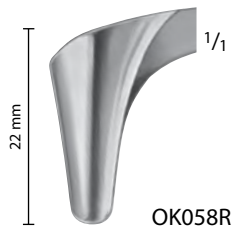

OK058R



MB318R



MB318R

BECKMANN Nasal Speculum W/ Screw Joint, Pediatric

Catalog Number	Blade Size	Blade Shape	Length (in.)
OK053R	SMALL	LAT-CVD	5 1/2
OK058R	MEDIUM	LAT-CVD	6

SONNENSCH EIN Nasal Speculum

Catalog Number	Blade Size	Length (in.)
MB318R	MEDIUM	6



OK100R-OK102R



OK103R

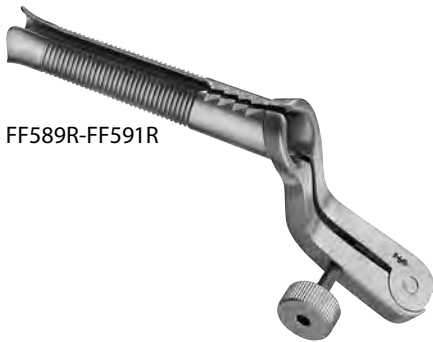

FF589R-FF591R



TE749R



FF595R

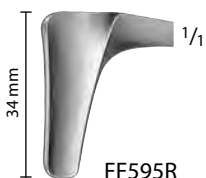

FF595R

CUSHING-LANDOLT Transsphenoidal Speculum

Catalog Number	Blade Size (mm)	Length (in.)
OK100R	70 x 15	-
OK101R	90 x 15	-
OK102R	110 x 15	-
OK103R	SPREADER FOR OK100R-OK102R	8 1/4

PAPAVERO-HARTMANN (CASPAR) Transsphenoidal Speculum, Slim, W/ Key

Catalog Number	Blade Size (mm)	Description	Length (in.)
FF589R	80 x 11	-	-
FF590R	90 x 13	-	-
FF591R	100 x 15	-	-
TE749R	-	HEX KEY	-
FF595R	34 x 9	SPREADER FOR FF589R-FF591R	5 1/2



OK804R-OK805R



OK804R

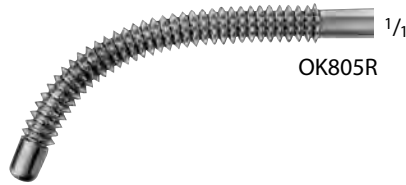

OK805R



MA421R

Antrum Rasp

Catalog Number	Tip	Length (in.)
OK804R	SHARP	7
OK805R	BLUNT	7

WEINER Antrum Rasp Trocar

Catalog Number	Tip	Length (in.)
MA421R	EXTRA SMALL, TROCAR	7 3/8



OL411R-OL410R



1/1

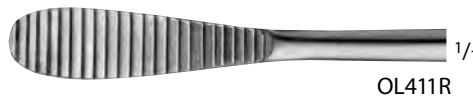

OL411R



1/1



OL410R

AUFRICHT Nasal Rasp

Catalog Number	Tip Size (mm)	Tip	Length (in.)
OL411R	9	DOWN-CUT	8 3/4
OL410R	9	UP-CUT	8 3/4



MA706R



MA706R

COTTLE Rasp

Catalog Number	Tip	Length (in.)
MA706R	DOWN CUTTING	8 1/4



MA417R-MA416R



MA417R



MA416R



OL405R

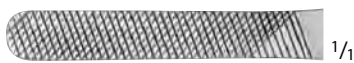

1/1

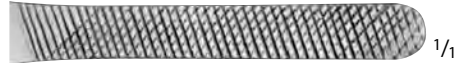

1/1

OL405R



OL406R



1/1



1/1

OL406R



MG584R

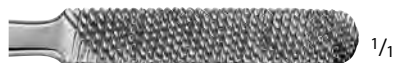

1/1

MG584R



MA418R



1/1



1/1

MA418R



OL412R



1/1



1/2

OL412R

Diamond Dust Rasp

Catalog Number	Tip	Length (in.)
MA417R	STR	7 3/8
MA416R	CVD	7 3/8

FOMON Bone Rasp, Double Ended

Catalog Number	Tip Size (mm)	Tip	Length (in.)
OL405R	6.5 / 7.5	X-SERR Fine/Coarse	8 1/2
OL406R	6.5 / 7.5	Fine/Coarse	8 1/2
MG584R	8/8	FLAT, CONVEX FINE, COARSE	8 1/2
MA418R	7.5 / 7.5	Coarse/ Xtra-Coarse	8 3/8

GALLAHER File Rasp, Coarse

Catalog Number	Tip Size (mm)	Length (in.)
OL412R	6.5	7 1/2



OL448R



OL451R

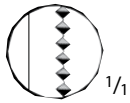

OL452R



OL401R-OL403R



OL401R



OL403R



OL408R-OL409R

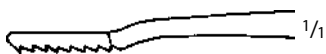

OL408R



OL409R

JOSEPH Nasal Saw, Bayonet

Catalog Number	Blade Shape	Length (in.)
OL448R	STR	7 3/4
OL451R	CVD RIGHT	7 3/4
OL452R	CVD LEFT	7 3/4

JOSEPH Nasal Saw

Catalog Number	Tip	Tip Size (mm)	Length (in.)
OL401R	FINE-SERR	7.5	6 1/2
OL403R	COARSE-SERR	9	6 1/2

LEWIS Bone Rasp

Catalog Number	Tip	Tip Size (mm)	Length (in.)
OL408R	FINE-SERR DOWN-STROKE	8	6 7/8
OL409R	COARSE-SERR DOWN-STROKE	8	6 7/8



MB110R



MB110R



OL407R

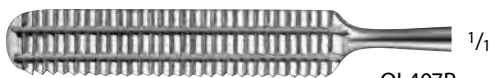

OL407R



MA419R



MA419R



MA420R



MA420R



MB330R



MB330R

MALTZ-ANDERSON Nasal Rasp

Catalog Number	Tip Size (mm)	Length (in.)
MB110R	5.7	6 1/2

MALTZ Bone Rasp

Catalog Number	Tip Size (mm)	Tip	Length (in.)
OL407R	9	DOWN-STROKE	6 1/2
MA419R	33	DOWN-STROKE	6 1/2
MA420R	33	UP STROKE	6 1/2

PARKES Nasal Rasp

Catalog Number	Tip Size (mm)	Length (in.)
MB330R	8	7 7/8



MA013R-MA016R



MA013R-MA016R

BALLENGER Chisel, V-shaped

Catalog Number	Tip Size (mm)	Length (in.)
MA013R	2	5 7/8
MA014R	4	5 7/8
MA016R	8	5 7/8



OL318R



OL318R

BALLENGER Septum Gouge

Catalog Number	Tip Size (mm)	Length (in.)
OL318R	6	6



MA017R



MA018R

CONVERSE Guarded Chisel

Catalog Number	Tip Size (mm)	Blade Shape	Length (in.)
MA017R	6	CVD RIGHT	7 1/2
MA018R	6	CVD LEFT	7 1/2



OL301R-OL304R

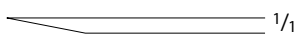

OL301R-OL304R

COTTLE Chisel W/ Depth Marks

Catalog Number	Tip Size (mm)	Length (in.)
OL301R	4	7
OL302R	7	7
OL303R	9	7
OL304R	12	7



OL311R

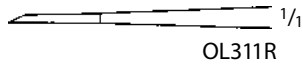

OL311R



OL314R

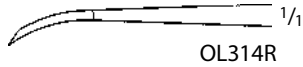

OL314R



FF610R



OL316R

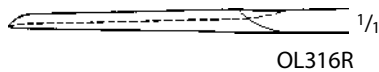

OL316R



OL336R



OL336R



MB108R, MA629R



MB108R, MA629R

FREER Chisel

Catalog Number	Tip Size (mm)	Blade Shape	Length (in.)
OL311R	4	STR	6 1/4
OL314R	4	CVD	6 1/4

PAPAVERO Bayonet Chisel

Catalog Number	Tip Size (mm)	Length (in.)
FF610R	4	8 3/4

FREER Septum Gouge

Catalog Number	Tip Size (mm)	Length (in.)
OL316R	4	6

KILLIAN Septum Gouge, Bayonet

Catalog Number	Tip Size (mm)	Length (in.)
OL336R	6	6 3/4

PARKES Hump Gouge, Double Guard

Catalog Number	Tip Size (mm)	Blade Shape	Length (in.)
MB108R	10	STR	7
MA629R	6	STR	7



MA382R



MA381R



MB590R-MB594R



MB590R-MB594R



MA369R

ANDERSON-NEIVERT Osteotome

Catalog Number	Tip Size (mm)	Blade Shape	Length (in.)
MA382R	5	CVD RIGHT	8
MA381R	5	CVD LEFT	8

CHERRY Osteotome

Catalog Number	Tip Size (mm)	Length (in.)
MB590R	3	8
MB591R	4	8
MB592R	5	8
MB593R	6	8
MB594R	7	8

CINELLI Osteotome, Double Guard

Catalog Number	Tip Size (mm)	Blade Shape	Length (in.)
MA369R	10	CVD	6 1/8



OL326R-OL329R



OL326R



OL327R



OL328R



OL329R



MB398R-MB403R



MB398R-MB403R



OL294R-OL300R



OL294R-OL300R

CINELLI Osteotome, Double Guard

Catalog Number	Tip Size (mm)	Blade	Length (in.)
OL326R	10	STR	6 1/4
OL327R	12	STR	6 1/4
OL328R	14	STR	6 1/4
OL329R	16	STR	6 1/4

CONVERSE Osteotome

Catalog Number	Tip Size (mm)	Length (in.)
MB398R	2	7
MB399R	4	7
MB400R	6	7
MB401R	8	7
MB402R	10	7
MB403R	12	7

COTTLE Osteotome, W/ Depth Mark

Catalog Number	Tip Size (mm)	Length (in.)
OL294R	4	7
OL296R	6	7
OL298R	8	7
OL299R	10	7
OL300R	12	7

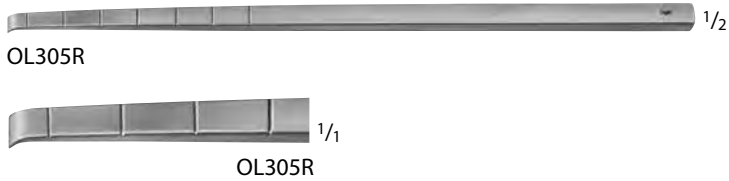

COTTLE Osteotome, Curved

Catalog Number	Tip Size (mm)	Length (in.)
OL305R	6	7

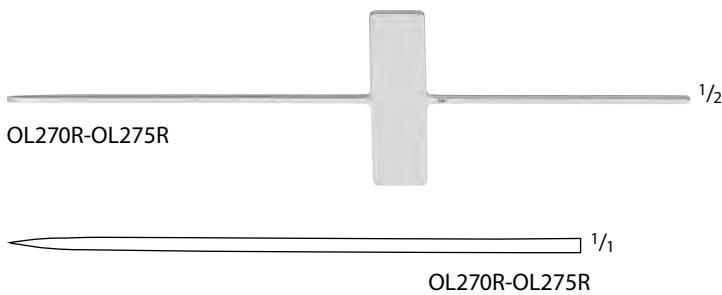

COTTLE Osteotome W/ Cross Bar

Catalog Number	Tip Size (mm)	Blade Shape	Length (in.)
OL270R	2	STR	7
OL271R	4	STR	7
OL272R	6	STR	7
OL273R	7	STR	7
OL274R	9	STR	7
OL275R	12	STR	7



TESSIER Osteotome

Catalog Number	Tip Size (mm)	Blade Shape	Length (in.)
OL360R	2.5	STR	6 1/4
OL361R	3.5	STR	6 1/4
OL362R	5	STR	6 1/4
OL366R	7	STR	6 1/4
OL368R	10	STR	6 1/4
OL370R	14	STR	6 1/4
OL371R	18	STR	6 1/4
OL363R	5	CVD	6 1/4
OL367R	7	CVD	6 1/4
OL369R	10	CVD	6 1/4

DAUTREY Osteotome

Catalog Number	Tip Size (mm)	Blade Shape	Length (in.)
OL344R	4	STR	6 3/4
OL345R	6	STR	6 3/4
OL346R	6	SLIGHTLY CVD	6 3/4
OL347R	6	STRONGLY CVD	6 3/4
OL348R	8	STR	6 3/4
OL349R	8	SLIGHTLY CVD	6 3/4
OL350R	8	STRONGLY CVD	6 3/4

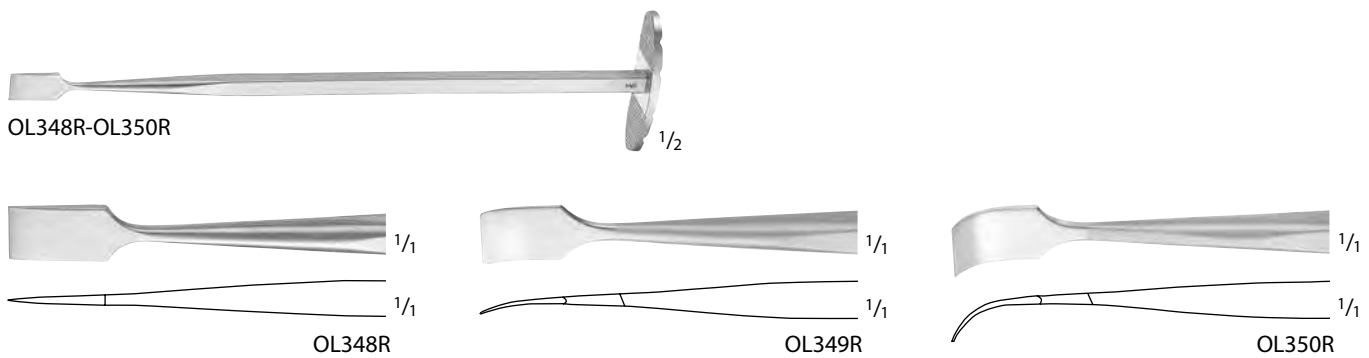
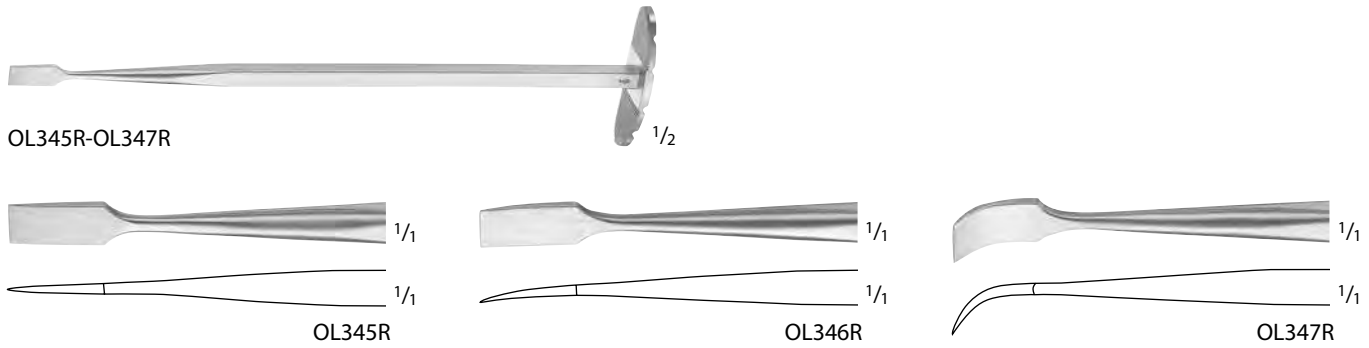
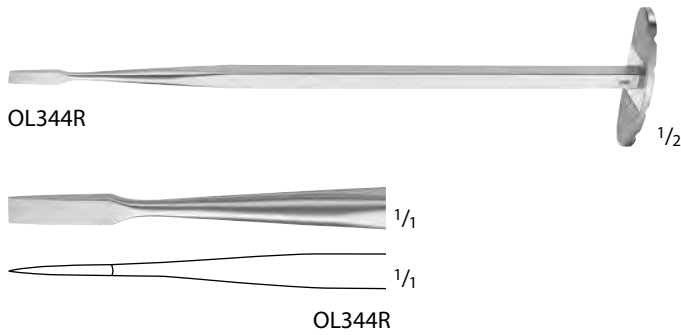



OL338R-OL339R

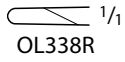

OL338R

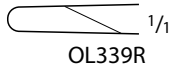

OL339R

FOMON Osteotome, Single Guard

Catalog Number	Tip Size (mm)	Length (in.)
OL338R	5	6 3/4
OL339R	8	6 3/4



OL323R



OL321R



OL322R

MASING Osteotome, Single Guard

Catalog Number	Blade	Length (in.)
OL323R	STR	6 7/8
OL321R	LEFT-CVD	6 7/8
OL322R	RIGHT-CVD	6 7/8



MA332R



MA333R



MA334R

OBEWESGESER Nasal Osteotome

Catalog Number	Tip Size (mm)	Length (in.)
MA332R	6	7 1/4
MA333R	8	7 1/4
MA334R	4	7 1/2



MB404R-MB373R



MB404R-MB373R

Osteotome W/ Hexagonal Handle

Catalog Number	Tip Size (mm)	Length (in.)
MB404R	2	6 1/4
MB405R	3	6 1/4
MB406R	4	6 1/4
MB407R	5	6 1/4
MB408R	6	6 1/4
MB409R	7	6 1/4
MB410R	8	6 1/4
MB411R	9	6 1/4
MB412R	10	6 1/4
MB413R	11	6 1/4
MB373R	12	6 1/4



MA384R

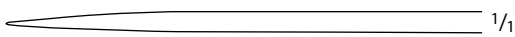

MA384R

RUBIN Osteotome, W/ Finger Grip

Catalog Number	Tip Size (mm)	Length (in.)
MA384R	14	6 1/4
MB388R	10	6 1/2
MB389R	14	6 1/2



MB388R



MB389R

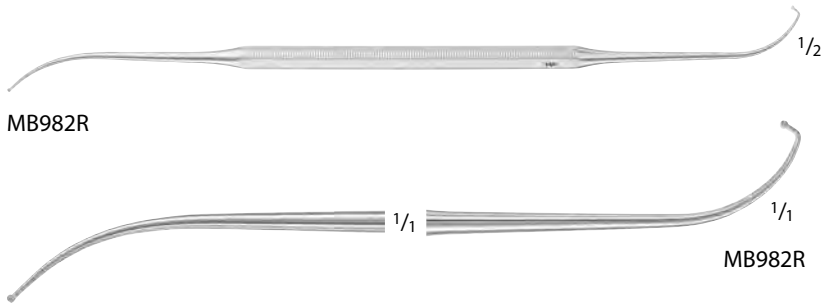

Frontal Ostium Seeker Probe, Double Ended

Catalog Number	Tip	Length (in.)
MB982R	CVD RIGHT, ANG	8 1/4



Maxillary Sinus Seeker Probe, Double Ended

Catalog Number	Tip	Tip Size (mm)	Length (in.)
MA642R	BALL	1.5 / 2	7 1/2



SKILLERN Sinus Probe

Catalog Number	Tip	Length (in.)
MA408R	MALLEABLE W/ BEADS AT 50, 70, AND 90 MM	6 3/4



BALLENGER Swivel Knife, Bayonet

Catalog Number	Blade Size (mm)	Length (in.)
OL354R	4 x 3	8 1/4
OL355R	5 x 4	8 1/4
OL356R	6 x 5	8 1/4



BALLENGER Swivel Knife, Straight

Catalog Number	Blade Width (mm)	Length (in.)
MA205R	3	7 1/2
MB119R	3	7 3/4
MB118R	4	7 3/4
MA207R	5	7 1/2



CONVERSE Septum Knife, Button End

Catalog Number	Blade	Length (in.)
OL109R	CVD	6



COTTLE Septum Knife, Round End

Catalog Number	Blade	Length (in.)
OL113R	STR	5 1/2





OL120R



OL120R



MA212R



MA212R



MA211R



OL111R



OL111R



OL107R



OL107R



OL102R-OL104R



OL102R



OL104R

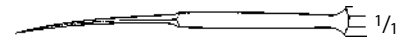

OL104R

FREER Septum Knife

Catalog Number	Blade Shape	Blade Size (mm)	Length (in.)
OL120R	"D" SHAPED	3	6
MA212R	"D" SHAPED	3	6 1/8
MA211R	ANG	5 x 8	7

JOSEPH Knife, Button End

Catalog Number	Tip	Length (in.)
OL111R	STR	5 1/2
OL107R	CVD	6 7/8

JOSEPH Knife, Double Edge

Catalog Number	Blade	Blade Size (mm)	Length (in.)
OL102R	STR	5 x 23	5 3/4
OL104R	CVD	5 x 23	5 3/4



Suction Tube, Angled

Catalog Number	Tip	Tip Size (Gauge)	Length (in.)
MA010R	ANG	13	3



Nasal Suction Tube W/ Luer Hub, Tapered

Catalog Number	Tip Size (mm)	Length (in.)
GF919R	5	7



FERGUSON-FRAZIER Suction Tube

Catalog Number	Tip	Tip Size (FR)	Working Length (in.)	Length (in.)
MA505R	ANG	8	7 7/8	10 1/4
MA506R	ANG	10	7 7/8	10 1/4
MA508R	ANG	14	4	6 1/2
MA504R	ANG	14	5 7/8	8



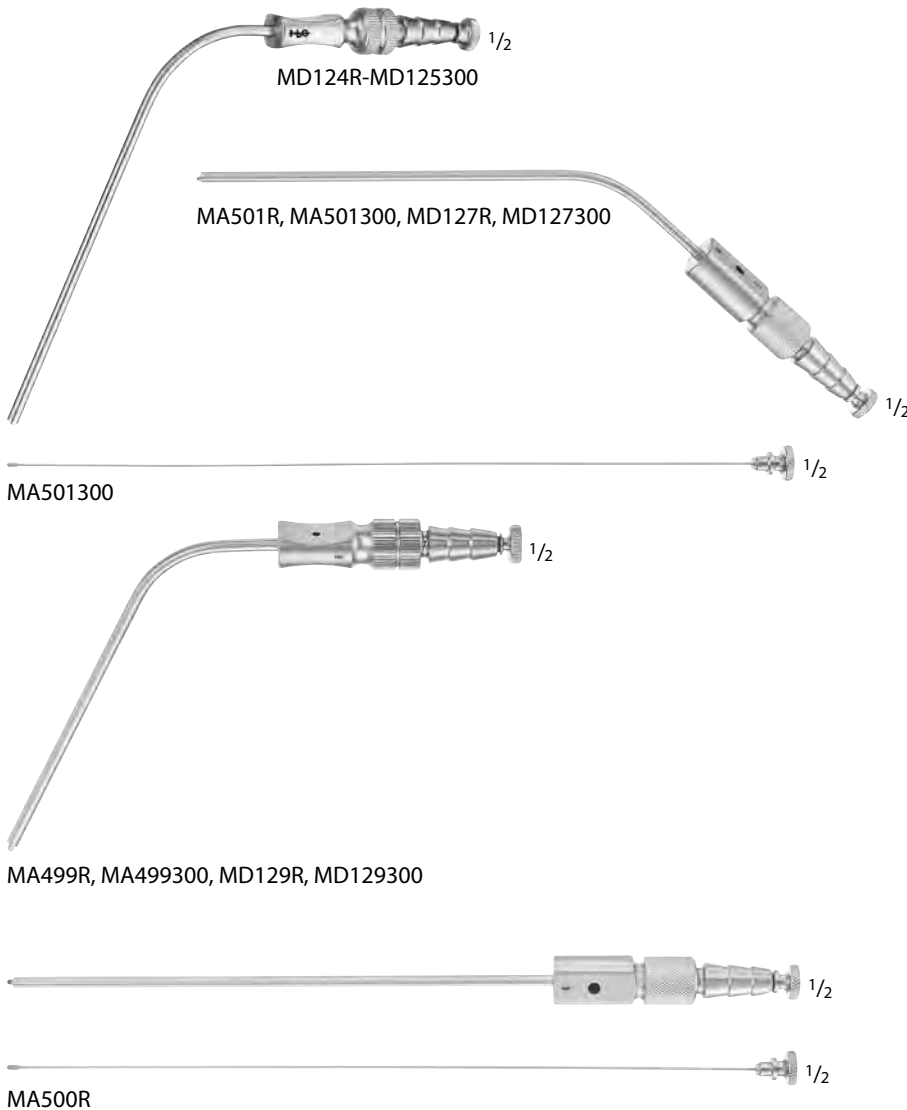

FRAZIER Suction Tube

Catalog Number	Tip Size (FR)	Description	Working Length (in.)
MD124R	7		4 1/4
MD124300	7	SUCTION STYLET W/ OLIVE TIP FOR MD124R	
MD125R	8		4 1/4
MD125300	8	SUCTION STYLET W/ OLIVE TIP FOR MD125R	
MA501R	9		4 1/4
MA501300		SUCTION STYLET W/ OLIVE TIP FOR MA501R	
MD127R	10		4 1/4
MD127300	10	SUCTION STYLET W/ OLIVE TIP FOR MD127R	
MA499R	11		4 1/4
MA499300	11	SUCTION STYLET W/ OLIVE TIP FOR MA499R	
MD129R	12		4 1/4
MD129300	12	SUCTION STYLET W/ OLIVE TIP FOR MD129R	

FRAZIER Suction Tube, Straight

Catalog Number	Tip	Working Length (in.)	Length (in.)
MA500R	STR	5 1/2	6 7/8



GF923R-GF925R

FRAZIER Suction Tube W/ Luer Hub

Catalog Number	Tip Size (FR)	Length (in.)
GF923R	9	7
GF925R	15	7



OK874C-OK875C

EICKEN Antrum Suction Tube, Bulbous

Catalog Number	Tip	Diameter (mm)	Length (in.)
OK874C	SMALL	2.5	5 1/8
OK875C	LARGE	3	5 1/8
MA594R	LONG CURVE	3	5 5/8
MA595R	SHORT CURVE	3	5 5/8
MA596R	SHORT CURVE	4	5 5/8



MA594R



MA595R



MA596R



MA011R-MA012R

KILLIAN Antrum Cannula

Catalog Number	Tip Size	Tip Size (#)	Length (in.)
MA011R	SMALL	1	5
MA012R	LARGE	2	5

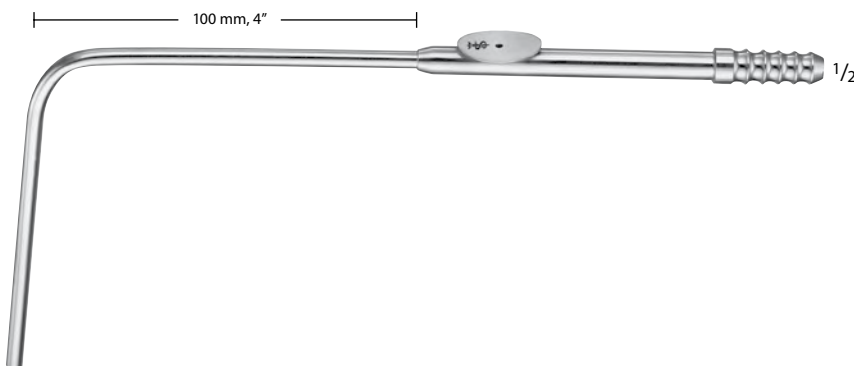

MB635R-MB636R

SACHS Suction Tube

Catalog Number	Tip Size	Length (in.)
MB635R	SMALL	8 1/2
MB636R	LARGE	8 1/2



OL168R



MA142R



OK900



MA607R



MA716R



MA715R

GORNEY Suction Dissector, Elevator

Catalog Number	Tip Size (mm)	Length (in.)
OL168R	6-10	7
MA142R	3	8 1/2

HAJEK Irrigating Cannula

Catalog Number	Diameter (mm)	Length (in.)
OK900	3.5	6 1/2

HOUSE Cutoff Adapter

Catalog Number	Tip	Tip Size (mm)
MA607R	TUBING END	4

Stopcock Luer Adapter, Female to Male

Catalog Number	Description
MA716R	FEMALE TO MALE LUER LOCK W/ FEMALE RIGHT

Luer Adapter

Catalog Number	Description
MA715R	MALE LUER LOCK-TO-HOSE



COTTLE Mallet, Flat/Round, 235gr

Catalog Number	Diameter (mm)	Length (in.)
FL038R	30	7 1/4

FL038R



CRANE Mallet

Catalog Number	Diameter (mm)	Length (in.)
MB303R	32	6 1/4

MB303R



Mallet, 155gr

Catalog Number	Diameter (mm)	Length (in.)
DF114R	25	7 1/2

DF114R



Lead Mallet

Catalog Number	Diameter (mm)	Handle	Description	Length (in.)
MA239R	25	LARGE	LEAD FILLED	7 1/16

MA239R

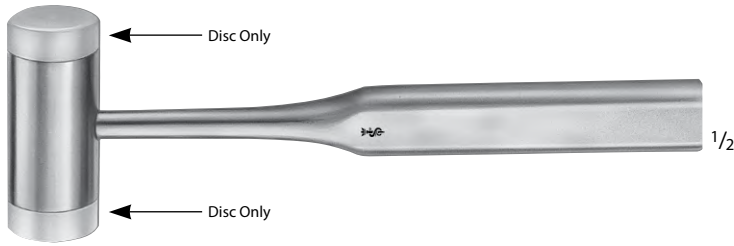

FL036R-FL037

Mallet W/ Removable Nylon Discs,
135gr

Catalog Number	Description	Diameter (mm)	Length (in.)
FL036R	COMPLETE	25	7 1/4
FL037	NYLON SPARE DISCS, F/FL036R, 2/SET	25	

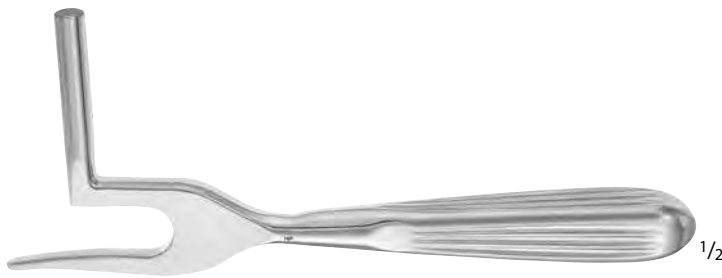

MA338R

QUISLING Intranasal Hammer

Catalog Number	Length (in.)
MA338R	6 3/4



FL093R-FL096R

Bone Tamp

Catalog Number	Diameter (mm)	Length (in.)
FL093R	3	6 1/4
FL094R	5	6 1/4
FL095R	7	6 1/4
FL096R	9	6 1/4



FL093R



FL094R



FL095R

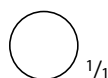

FL096R



MA589R-MA593R



MA589R



MA588R



MA592R



MA593R



FK651R-FK654R

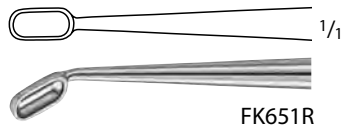

FK651R

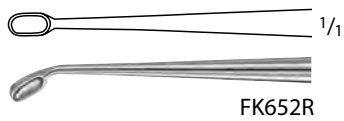

FK652R

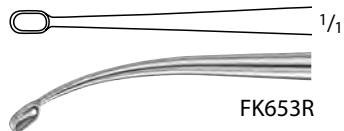

FK653R

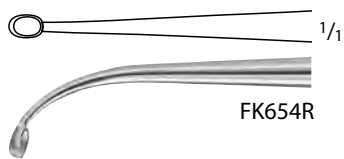

FK654R



MA591R



MA591R



MA590R



MA590R

Antrum Curette

Catalog Number	Tip	Tip Size (mm)	Length in.)
MA589R	OBLONG	-	7 1/2
MA588R	OVAL CUP	7 x 11	7 1/2
MA592R	OVAL CUP	8 x 11	7 1/2
MA593R	OVAL CUP	9 x 13	7 1/2
FK651R	OVAL CUP, ANG	9.5 x 4	7 1/2
FK652R	OVAL CUP, ANG	6 x 3	7 1/2
FK653R	55° CVD	6 x 3	7 1/2
FK654R	90° CVD	6 x 3	7 1/2
MA591R	BACKWARD CUTTING	7 x 10	7 1/2
MA590R	FORWARD CUTTING	7 x 10	7 1/2



FK817R

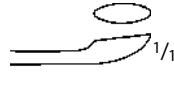

FK817R

BARTH Bone Curette, Double Ended

Catalog Number	Tip Size (mm)	Length (in.)
FK817R	2.3 x 6.0 / 2.7 x 7.0	7



OK811R-OK816R



OK811R

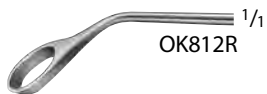

OK812R



OK813R



OK814R



OK815R

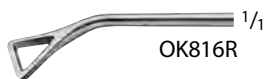

OK816R

COAKLEY Antrum Curette

Catalog Number	Blade	Size (#)	Length (in.)
MB799R	-	SET OF 6 INCLUDES OK811R- OK816R	-
OK811R	SLIGHT ANG	1	6 3/4
OK812R	45°	2	6 3/4
OK813R	REV ANG	3	6 3/4
OK814R	SLIGHT ANG	4	6 3/4
OK815R	45°	5	6 3/4
OK816R	45°	6	6 3/4



FK813R



FK803R



FK840R

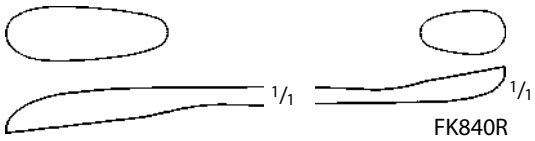

FK842R

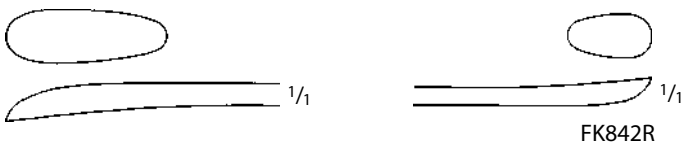

FK814R



JACOBSON Bone Curette, Double Ended

Catalog Number	Tip Size (mm)	Length (in.)
FK813R	4.3 x 6.5 / 4.5 x 8.5	5 1/2

JANSEN Bone Curette, Double Ended

Catalog Number	Diameter (mm)	Length (in.)
FK803R	4.3 / 3.6	6 1/4

VOLKMANN Bone Curette, Double Ended

Catalog Number	Tip Size (mm)	Length (in.)
FK840R	7.5 x 21.0 / 6.0 x 11.0	5 1/8
FK842R	7.5 x 21.0 / 6.0 x 11.0	6 3/4

WILLIGER Bone Curette, Double Ended

Catalog Number	Tip Size (mm)	Length (in.)
FK814R	2.0 x 3.5 / 3.0 x 4.5	5 3/4



LEMPERT Bone Curette

Catalog Number	Size (#)	Length (in.)
MA037R	000000	8
MA038R	00000	8
MA039R	0000	8
MA044R	2	8



MA037R



MA038R



MA039R



MA044R

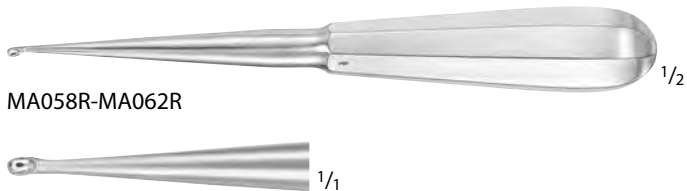

SPRATT Mastoid Curettes

Catalog Number	Tip Size (mm)	Size (#)	Length (in.)
MA058R	2.5 x 4	00	6 1/2
MA059R	3 x 5	0	6 1/2
MA060R	3.5 x 6	1	6 1/2
MA061R	4.5 x 8	3	6 1/2
MA062R	5.5 x 9	4	6 1/2



MA058R



MA059R



MA060R



MA061R



MA062R

ALEXANDER Bone Rongeur

Catalog Number	Jaw Size (mm)	Jaw	Length (in.)
FO440R	3.2 x 27	ANG	5 1/2



BANE-HARTMANN Bone Rongeur

Catalog Number	Jaw Size (mm)	Jaw	Length (in.)
FO457R	4.0 x 32	CVD	6 7/8



BEYER Bone Rongeur

Catalog Number	Jaw Size (mm)	Jaw	Handle	Length (in.)
FO453R	3.2 x 32	CVD	Single Action	7
FO514R	4.0 x 30	CVD	Double Action	7

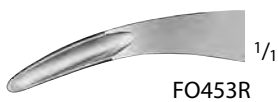



FO415R



FO415R



FO500R-FO502R



FO500R



FO502R

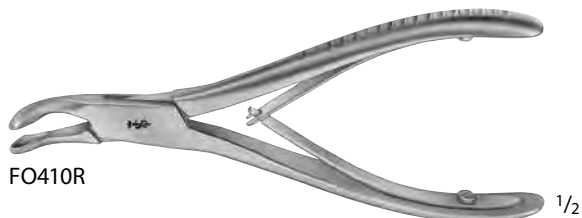

FO410R



FO410R

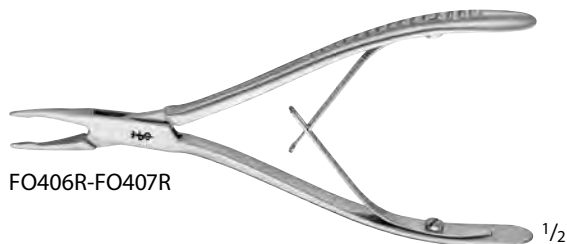

FO406R-FO407R



FO406R



FO407R

BLUMENTHAL Bone Rongeur

Catalog Number	Jaw Size (mm)	Jaw	Length (in.)
FO415R	3.5 x 25	CVD	6 1/8

BOEHLER Bone Rongeur, Double Action

Catalog Number	Jaw Size (mm)	Jaw	Jaw End	Length (in.)
FO500R	3.0 x 27	CVD	NARR	6 1/8
FO502R	3.5 x 30	CVD	WIDE	6 1/8

Bone Rongeur

Catalog Number	Jaw Size (mm)	Jaw	Length (in.)
FO410R	3.8 x 19	CVD	5 1/2

FRIEDMANN Micro Rongeur

Catalog Number	Jaw Size (mm)	Jaw	Length (in.)
FO406R	1.3 x 19	STR	5 1/2
FO407R	1.3 x 20	CVD	5 1/2

JANSEN Bone Rongeur

Catalog Number	Jaw Size (mm)	Jaw	Length (in.)
FO430R	4.2 x 35	STR	6 7/8
FO432R	4.5 x 30	CVD	6 7/8
FO442R	3.8 x 37	ANG	7 1/2



FO430R-FO432R



FO430R



FO432R



FO442R

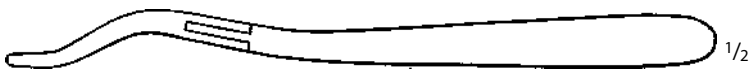

FO442R

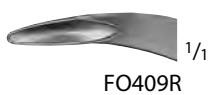
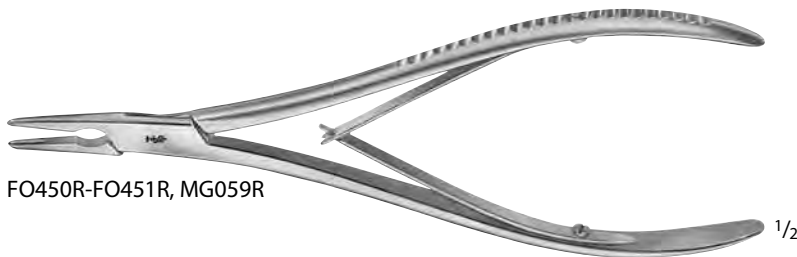
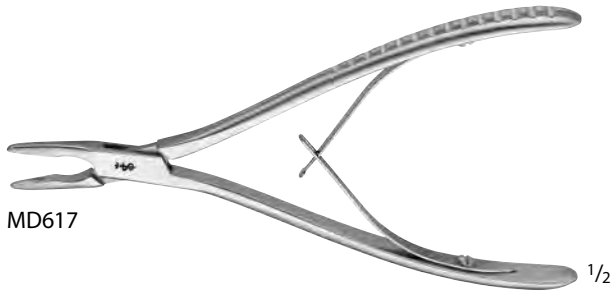

LEMPERT Bone Rongeur

Catalog Number	Jaw Size (mm)	Jaw	Length (in.)
MD617	2.0 x 23	DEL, STR	6 1/2
FO450R	2.2 x 27	STR	7 7/8
MG059R	2.5 x 30	CVD	6 1/4
FO451R	2.2 x 27	CVD	7 7/8

LUER Bone Rongeur

Catalog Number	Jaw Size (mm)	Jaw	Length (in.)
FO411R	4.2 x 20	CVD	6
FO412R	4.2 x 26	STRONG CVD	6 1/8

LUER-FRIEDMANN Bone Rongeur

Catalog Number	Jaw Size (mm)	Jaw	Length (in.)
FO409R	2.2 x 22	CVD	5 3/4

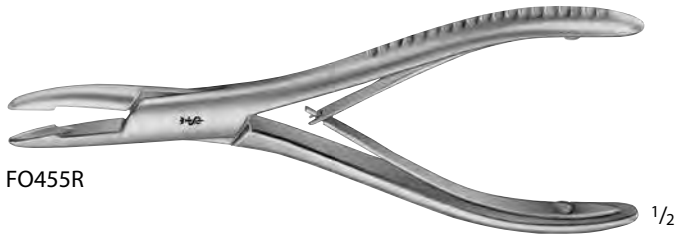

FO455R

1/2



1/1

FO455R

MEAD Bone Rongeur

Catalog Number	Jaw Size (mm)	Jaw	Length (in.)
FO455R	3.5 x 30	CVD	6 1/2



FO515R

1/2



1/1

FO515R

ZAUFAL-JANSEN Bone Rongeur,
 Double Action

Catalog Number	Jaw Size (mm)	Jaw	Length (in.)
FO515R	4.5 x 29	CVD	7



ENT-ORAL

Scissors	706 - 708
Needles	709
Forceps	709 - 712
Clamps	713 - 719
Tracheal Dilators / Hooks / Retractors	720 - 721
Retractors	722 - 724
Tonsil Dissectors	725
Adenotomes, Tonsil Snares and Wires	726 - 728
Mouth Gags	729 - 737
Tonsil Knives	738
Suction Tubes	739
Adenoid Curettes	740 - 742
Syringes	743
Laryngeal Mirrors	744
Amalgam Carriers	745

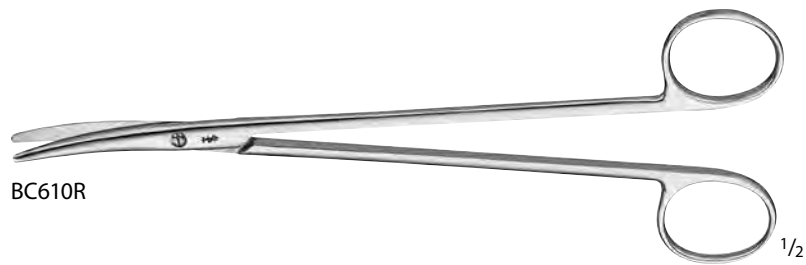

LILLIE Dissecting Scissors

Catalog Number	Tip	Blade	Length (in.)
BC610R	B/B	CVD	7 7/8

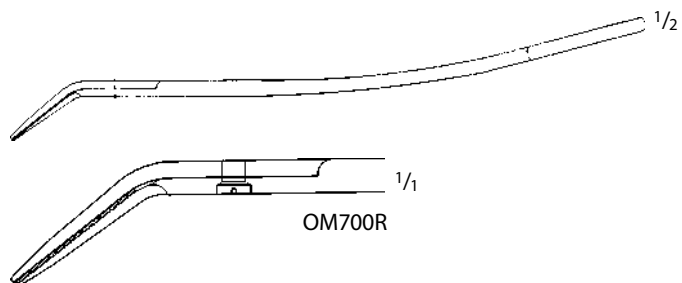
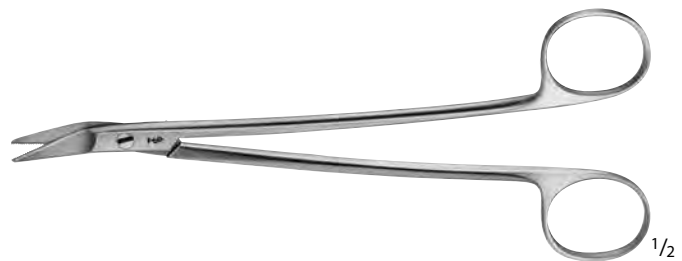

DEAN Tonsil Scissors

Catalog Number	Tip	Blade	Length (in.)
OM700R	B/B	ANG-SERR	6 3/4

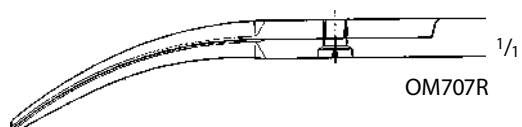

BOETTCHER Tonsil Scissors

Catalog Number	Tip	Blade	Length (in.)
OM707R	B/B	CVD	7

BROPHY Gum Scissors

Catalog Number	Tip	Blade	Length (in.)
MA445R	S/S	CVD	5 1/2

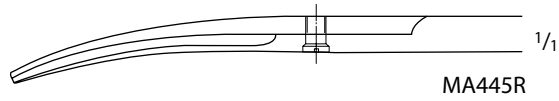

DUROTIP™ Tungsten Carbide Scissors

- Excellent cutting accuracy
- Long working life
- Gold-plated rings

DUROTIP TC Gum Scissors, Delicate

Catalog Number	Tip	Blade	Length (in.)
DO208R	S/S	STR	4 3/4
DO209R	S/S	CVD	4 3/4

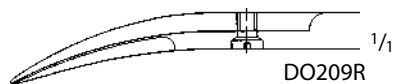
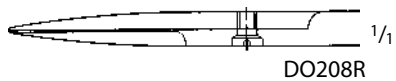
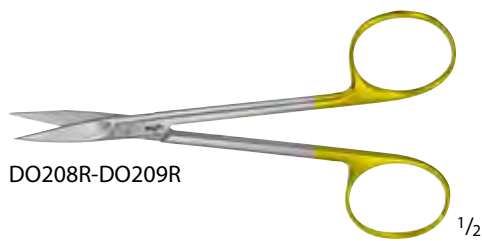

Micro Laryngeal Scissors, W/ Flush Port

Catalog Number	Tip	Blade	Working Length (in.)
OP310R	S/S	STR	9 3/4
OP311R	S/S	CVD-LEFT	9 3/4
OP312R	S/S	CVD-RIGHT	9 3/4
OP313R	S/S	ANG-UP	9 3/4

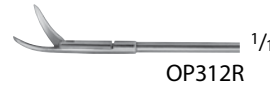
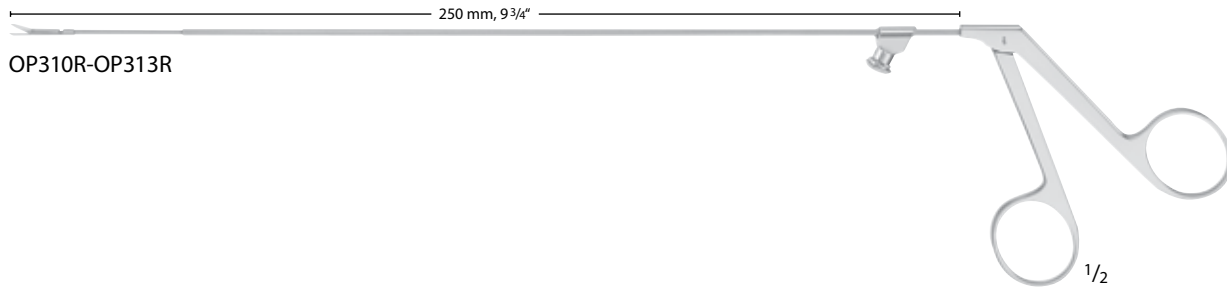

KLEINSASSER Micro Scissors

Catalog Number	Tip	Blade	Blade Size (mm)	Working Length (in.)
MA460R	B/B	STR	4	14

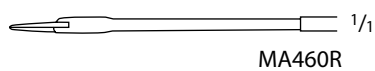

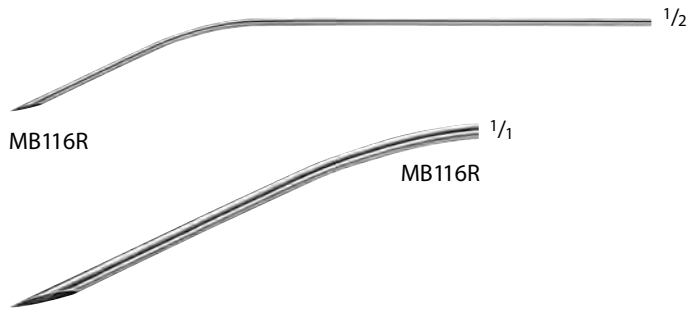

DINGMAN Wire Passing Needle

Catalog Number	Tip	Length (in.)
MB116R	CVD	6 3/4

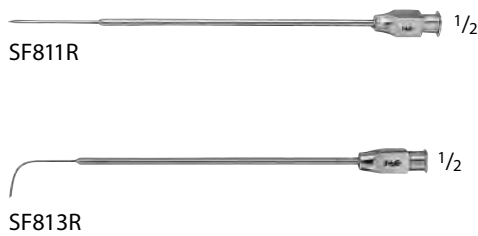

Tonsil Needle, 23 Gauge

Catalog Number	Tip	Tip Size (mm)	Length (in.)
SF811R	STR	DIAM. 0.8	3
SF813R	CVD	DIAM. 0.8	3

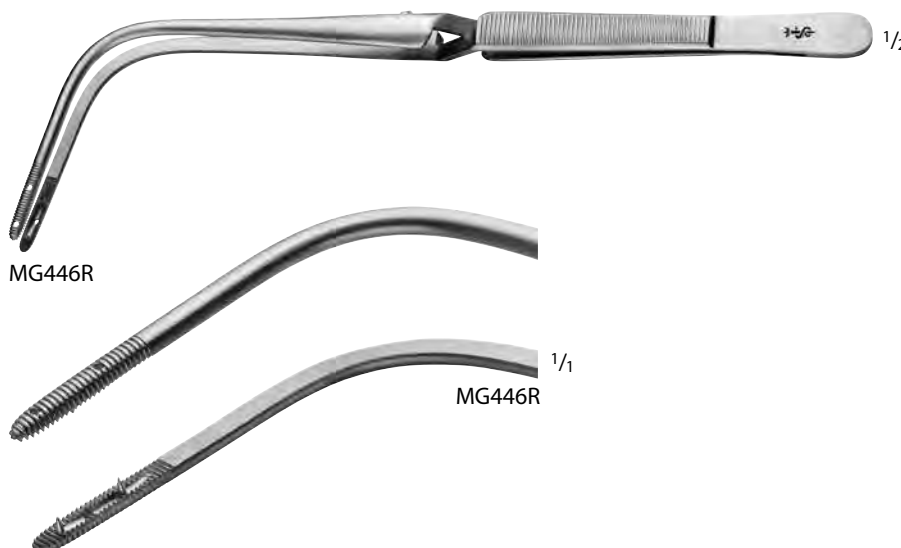

JACKSON Laryngeal Self-Closing Dressing Forceps

Catalog Number	Tip	Teeth	Length (in.)
MG446R	SERR	1 x 2	9

Laryngeal Forceps, W/ Flush Port

Catalog Number	Jaw	Working Length (in.)
OP300R	STR	9 3/4
OP301R	CVD-LEFT	9 3/4
OP302R	CVD-RIGHT	9 3/4

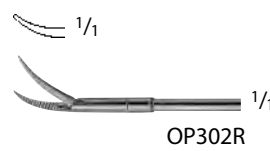
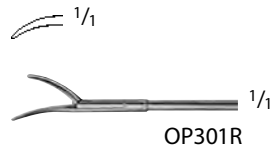
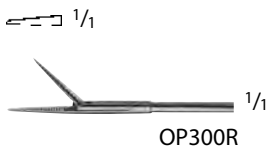
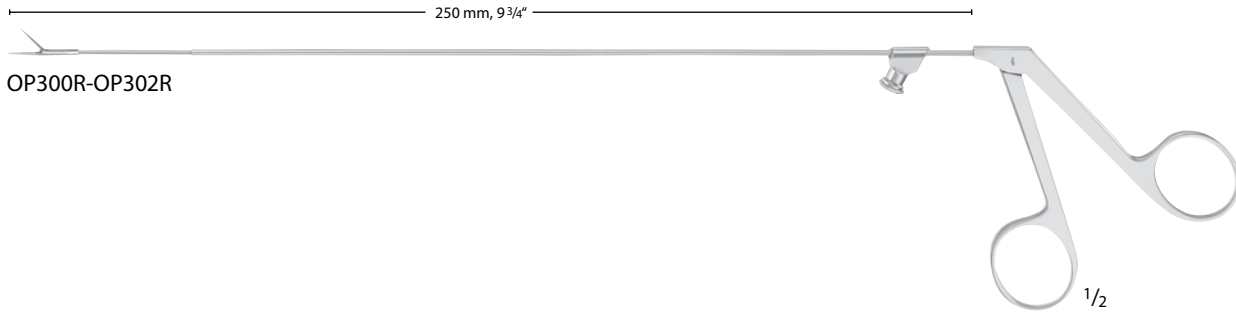

Micro Laryngeal Cup Forceps, W/ Flush Port

Catalog Number	Cup Size (mm)	Jaw	Working Length (in.)
OP304R	2	STR	9 3/4
OP305R	2	ANG-LEFT	9 3/4
OP306R	2	ANG-RIGHT	9 3/4
OP307R	2	ANG-UP	9 3/4

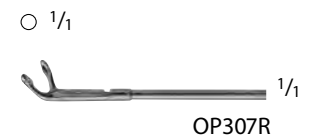
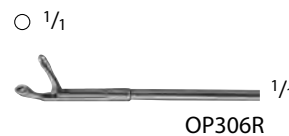
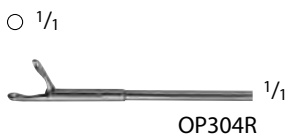
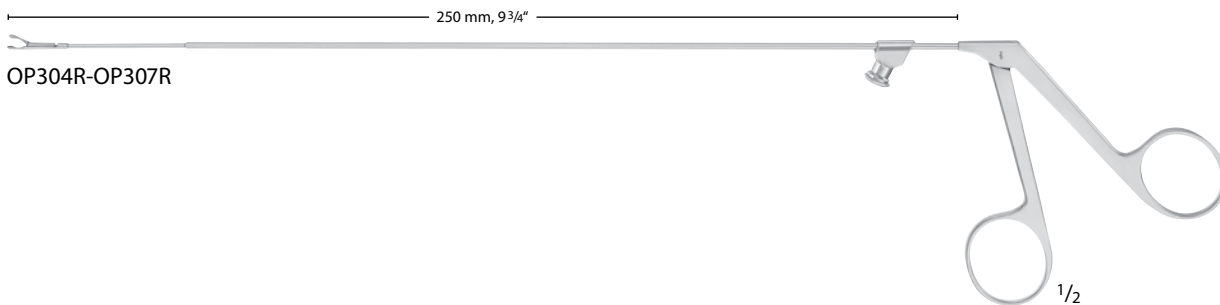

Alligator Grasping Forceps

Catalog Number	Tip	Tip Size (mm)	Working Length (in.)	Length (in.)
MA663R	SERR	8.8 x 4	11	13 3/4





MA645R

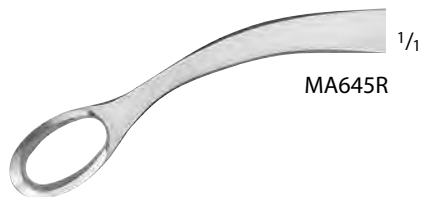

MA645R

ST CLAIR Adenoid Forceps

Catalog Number	Length (in.)
MA645R	7 1/2

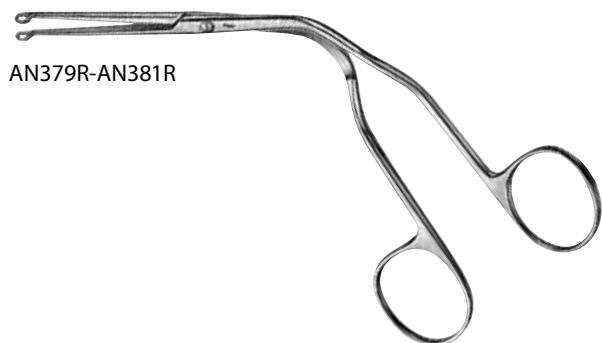

AN379R-AN381R



AN379R

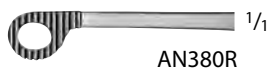

AN380R



AN381R

MAGILL Forceps

Catalog Number	Size	Length (in.)
AN379R	INFANT	6
AN380R	PEDIATRIC	7 7/8
AN381R	ADULT	9 3/4

SCHNIDT Tonsil Clamp

Catalog Number	Ring Handle	Jaw	Length (in.)
MA172R	OPEN RING	STR	7 1/2
BH961R	OPEN-RING	SLIGHT-CVD	7 1/4
BH963R	OPEN-RING	CVD	7 1/4
BH957R	CLOSED-RING	SLIGHT-CVD	7 1/4
BH959R	CLOSED-RING	CVD	7 1/4

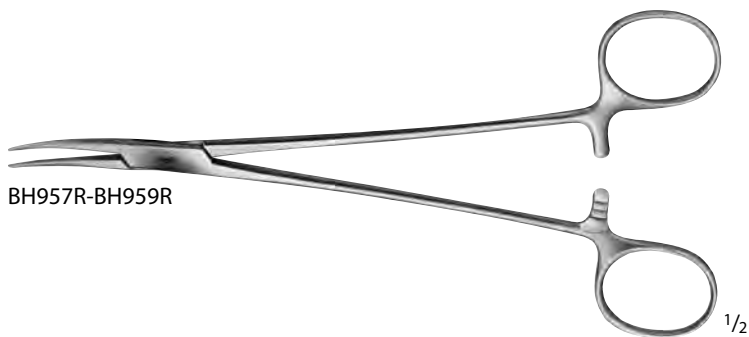
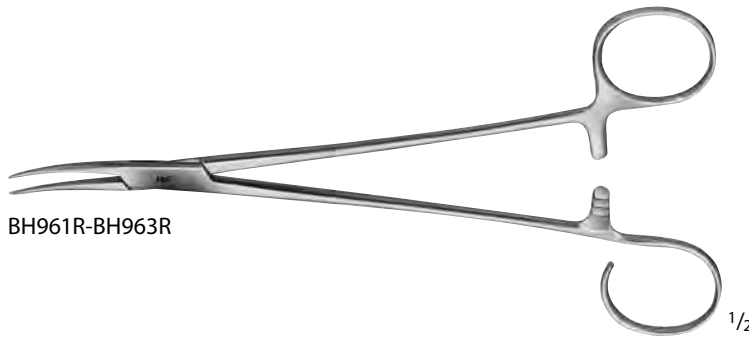

Tonsil Clamp, X-long

Catalog Number	Jaw	Length (in.)
MB103R	CVD	14 1/2

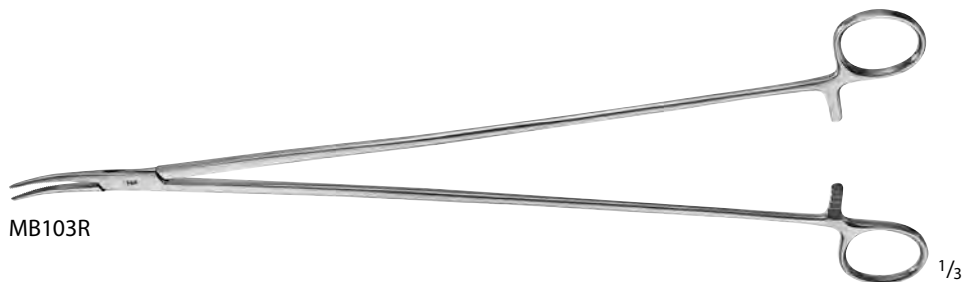

ADSON Tonsil Clamp, Delicate

Catalog Number	Jaw	Length (in.)
BH200R	STR	7 1/4
BH201R	CVD	7 1/4

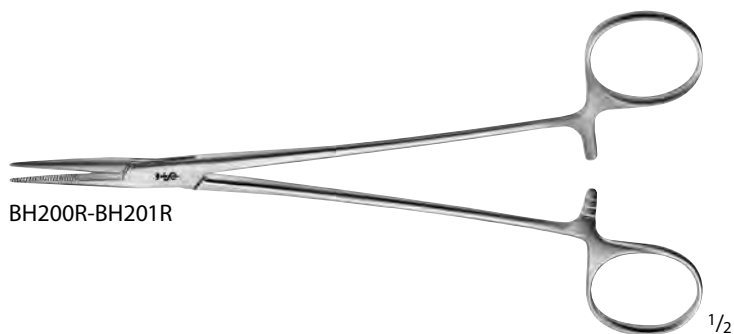

NISSEN Tonsil Clamp, Delicate

Catalog Number	Jaw	Length (in.)
BH199R	CVD	7 1/4

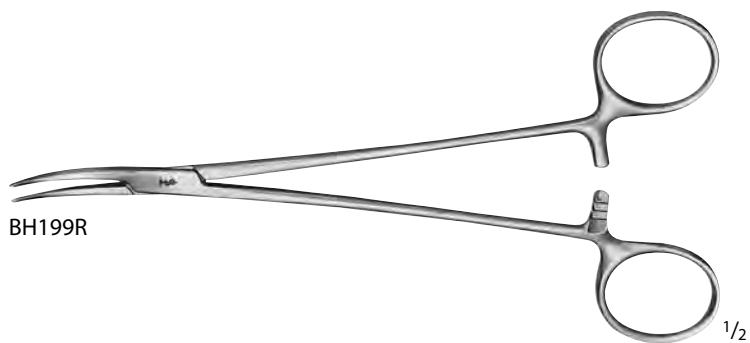

NEGUS Tonsil Clamp

Catalog Number	Jaw	Length (in.)
BH951R	HEAVY-CVD	7 1/2
BH952R	U-CVD	7 1/2

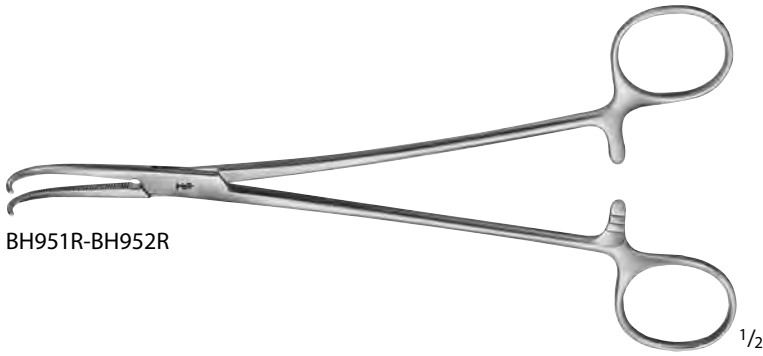

BH951R-BH952R

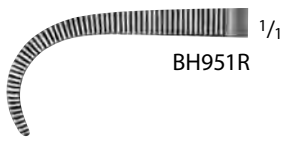

BH951R

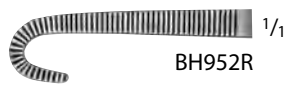

BH952R

MCHENRY Tonsil Artery and Sponge Holding Clamp

Catalog Number	Jaw	Length (in.)
MB533R	CVD	8

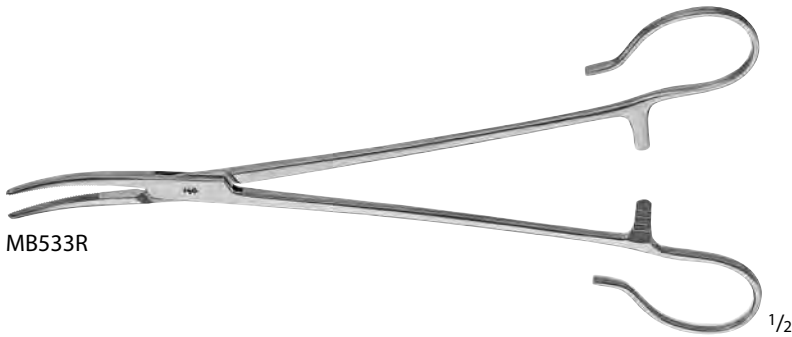

MB533R

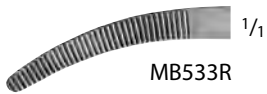

MB533R



OM602R

1/2

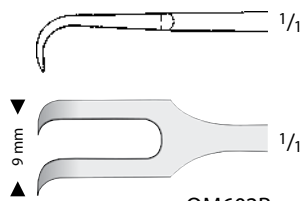

OM602R

MUSEUX Tonsil Clamp

Catalog Number	Tip	Length (in.)
OM602R	2 x 2	7 7/8



OM612R

1/2

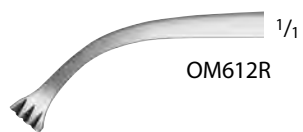

OM612R

WHITE Tonsil Seizing Clamp

Catalog Number	Length (in.)
OM612R	7
OM613R	9 1/4

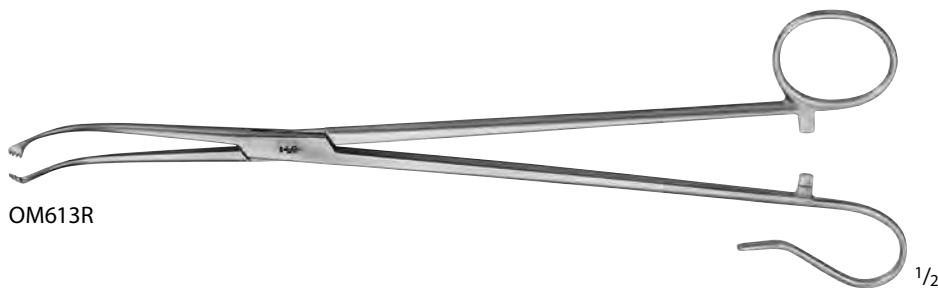

OM613R

1/2

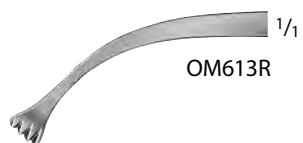

OM613R

ALLIS-COAKLEY Tonsil Clamp

Catalog Number	Jaw	Length (in.)
MA539R	STR	7 7/8
MA540R	STRONG CVD	7 5/8



COLVER Tonsil Seizing Clamp

Catalog Number	Length (in.)
OM611R	7 7/8





COLLIN Tongue Clamp

Catalog Number	Jaw	Length (in.)
BH906R	OVAL	6 1/4



HEYWOOD-SMITH Tongue Clamp

Catalog Number	Tip	Length (in.)
AN710R	SERR	7 7/8
AN711R	SERR	8 1/4



AN710R



AN710R

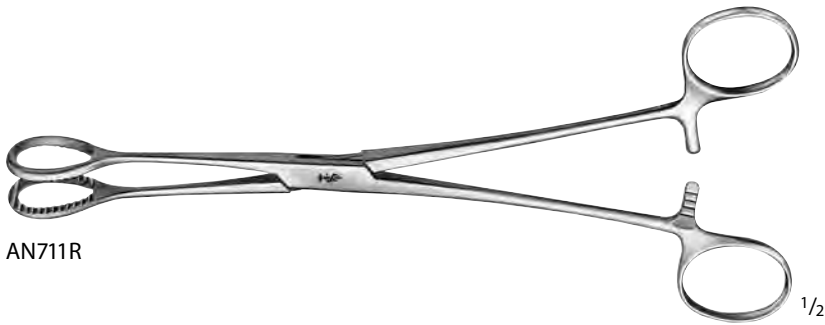

AN711R

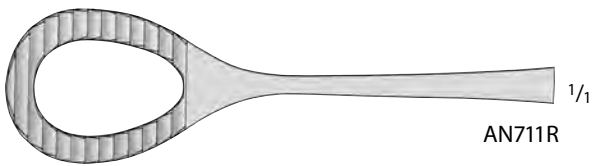

AN711R



FA025R

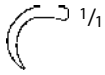

FA026R

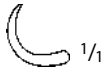

BT103R-BT107R



BT103R



BT106R



BT107R



MB230



MB230

BOSE Tracheal Hook

Catalog Number	Tip	Length (in.)
FA025R	CVD-LEFT	6 1/2
FA026R	CVD-RIGHT	6 1/2

Tracheal Retractor

Catalog Number	Tip	Blade End	Length (in.)
BT103R	SHARP	1 PRONG	7
BT106R	BLUNT	1 PRONG	7
BT107R	BLUNT	2 PRONGS	7

JACKSON Tracheal Retractor

Catalog Number	Length (in.)
MB230	7



FA005R

TROUSSEAU Tracheal Dilator

Catalog Number	Length (in.)
FA005R	4 3/4



FA006R

LABORDE Tracheal Dilator

Catalog Number	Length (in.)
FA006R	5
FA007R	5 1/4

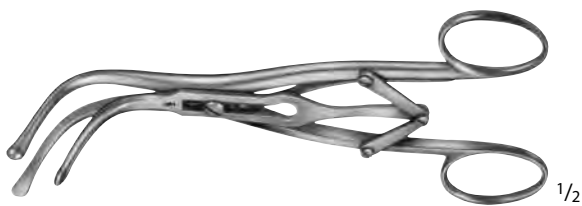

FA007R

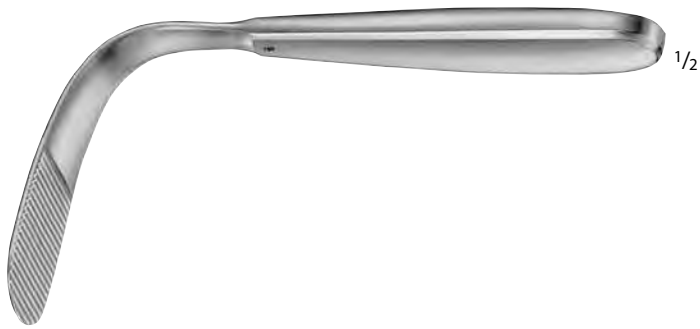

OM235R

TOBOLD Tongue Depressor

Catalog Number	Length (in.)
OM235R	6 1/4



OM236R-OM237R

WEDER Tongue Depressor

Catalog Number	Size	Length (in.)
OM236R	SMALL	5
OM237R	LARGE	5

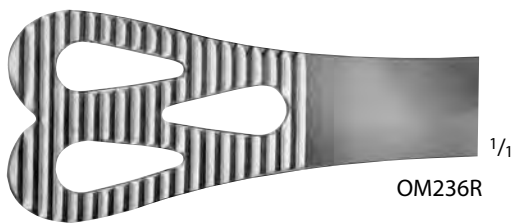

OM236R

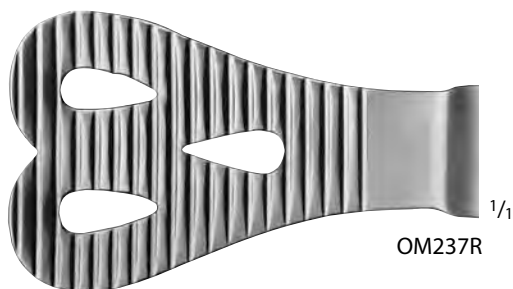

OM237R

LOTHROP Uvula Retractor

Catalog Number	Blade Size (mm)	Length (in.)
MA719R	17 x 20	9 5/8

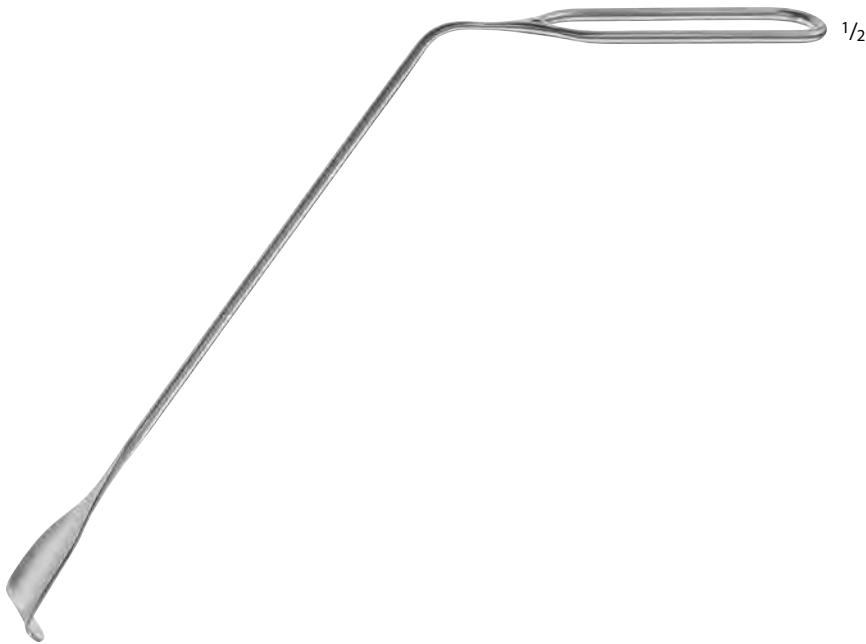

MA719R



MA719R

GOODYEAR Uvula Retractor

Catalog Number	Blade Size (mm)	Length (in.)
MA608R	15	7 3/8



MA608R

LAHEY Goiter Retractor

Catalog Number	Blade Size (mm)	Length (in.)
MB785R	24 x 8	7 7/8



MB785R



MB785R



MA434R-MA437R

SEWALL Orbital Retractor

Catalog Number	Blade Size (mm)	Length (in.)
MA434R	7 x 52	6 3/4
MA435R	9 x 44	6 3/8
MA436R	11 x 50	6 3/8
MA437R	13 x 67	6 3/4

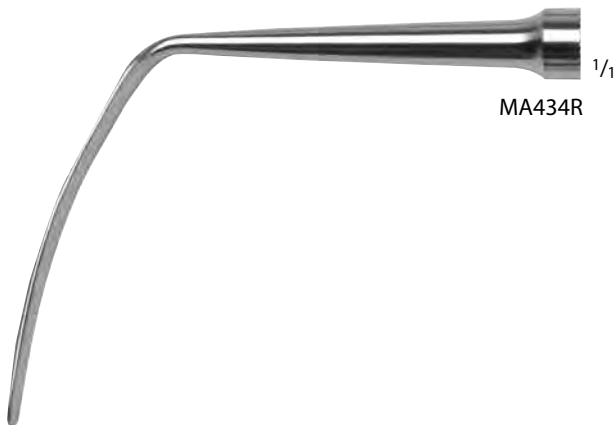

MA434R



MA435R



MA436R

HURD Tonsil Dissector / Pillar Retractor

Catalog Number	Tip Size (mm)	Length (in.)
OM660R	6	8 1/2
OM661R	10	8 1/2

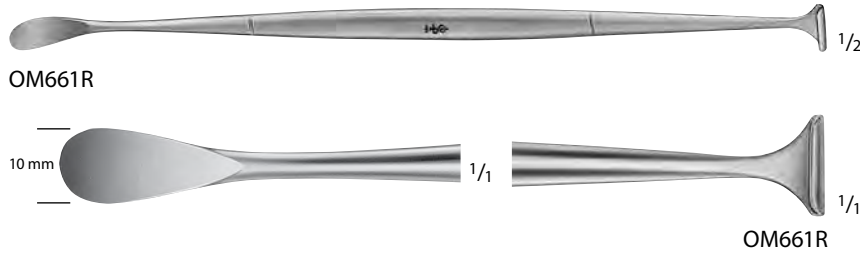
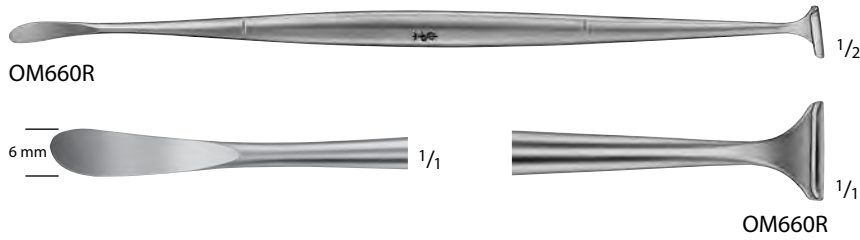

HENKE Tonsil Dissector

Catalog Number	Tip Size (mm)	Length (in.)
OM668R	12	9 1/4

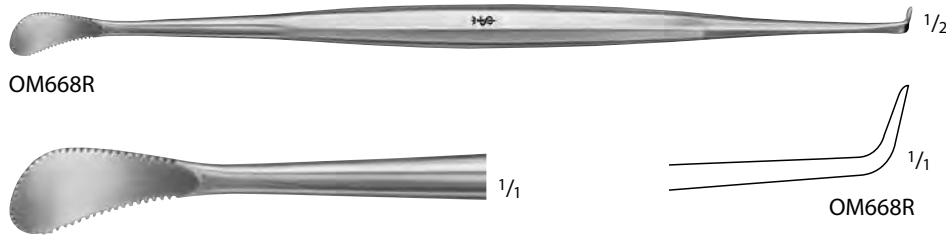

LOTHROP Tonsil Knife and Dissector

Catalog Number	Length (in.)
MA289R	8 1/4



OM391R-OM398R

LA FORCE Adenotome

Catalog Number	Size (#)	Description	Length (in.)
OM391R	1	-	9 1/4
OM392R	2	-	9 1/4
OM393R	3	-	9 1/4
OM396R	-	SPARE BLADE F/ OM391R	-
OM397R	-	SPARE BLADE F/ OM392R	-
OM398R	-	SPARE BLADE F/ OM393R	-



OM396R



1/1



OM397R



1/1



OM398R



1/1

EVES Tonsil Snare W/ 25 Gauge Wire

Catalog Number	Description	Length (in.)
OM760R	W/O RATCHET	9 3/4
OM761R	W/ RATCHET	9 3/4



OM760R

1/2



OM761R

1/2

LEWIS Tonsil Snare

Catalog Number	Description	Length (in.)
MA714R	INCLUDES 12 #8 SNARE WIRES	10 1/4



MA714R

SAGE Tonsil Snare

Catalog Number	Description	Length (in.)
MA493R	W/ SNARE WIRES	11
MA490R	12 #6 SNARE WIRES	4

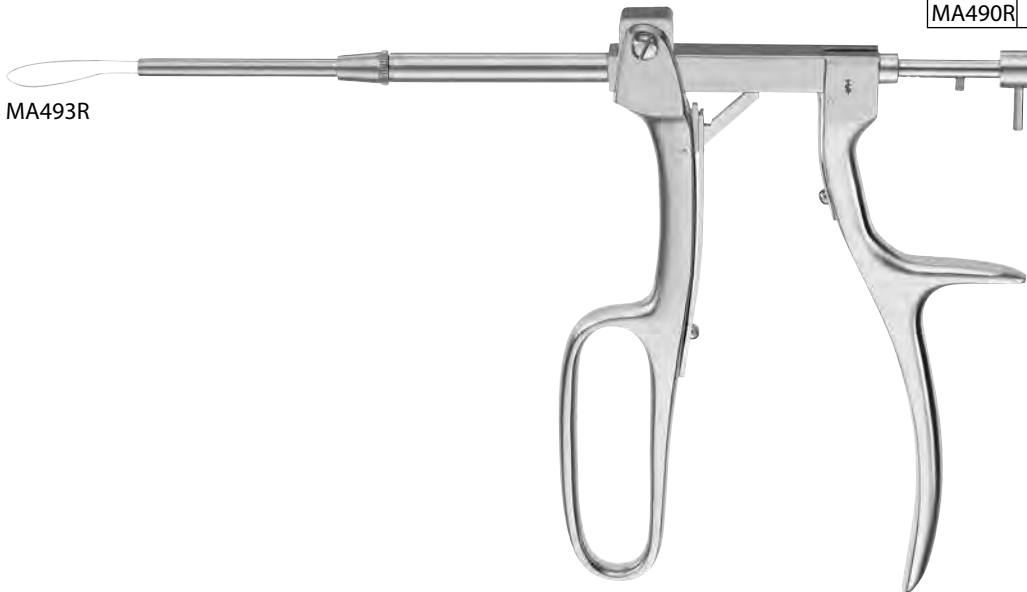

MA493R

1/2



1/4

MA490R

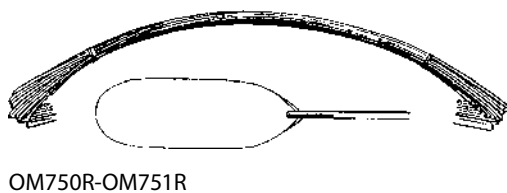
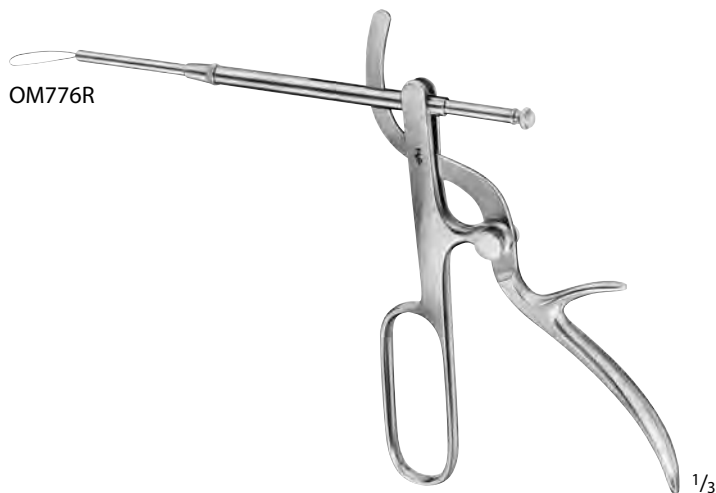

TYDING Tonsil Snare

Catalog Number	Description
OM781R	-
OM776R	TIP ONLY, STR

Tonsil Snare Wire

Catalog Number	Diameter (mm)	Size (#)	Sales Unit	Length (mm)
MA490R	1.4	6	12/BOX	100
OM750R	0.3	7	12/BOX	100
OM751R	0.5	8	12/BOX	100

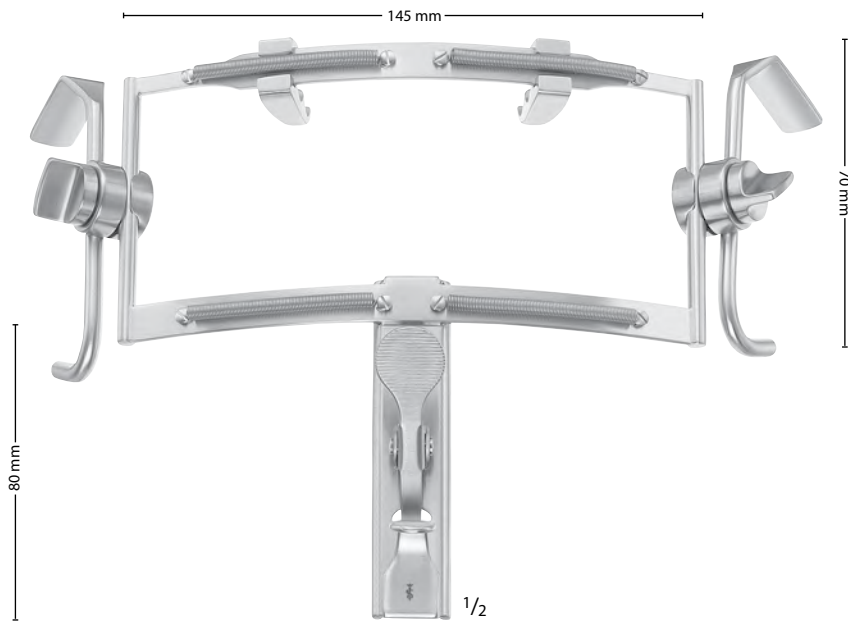

DINGMAN Mouth Gag

Catalog Number	Description
MA299R	COMPLETE SET WITH 3 BLADES AND FRAME

MA299R Includes:
 1 Mouth Gag OM105R,
 1 Blade of each OM171R, OM172R, OM177R

MA299R



OM038R

MOLT Mouth Gag, Pediatric

Catalog Number	Description	Length (in.)	Length (m)
OM038R	-	4	-
TA009706	SPARE SILICONE TUBE ONLY, LATEX-FREE	-	1

TA009706 Protective covers for OM038R and OM040R available as silicone tubing which may be cut to length



OM040R, TA009706

DOYEN-COLLIN Mouth Gag

Catalog Number	Description	Length (in.)	Length (m)
OM040R	-	4 3/4	-
TA009706	SPARE SILICONE TUBE ONLY, LATEX-FREE	-	1

TA009706 Protective covers for OM038R and OM040R available as silicone tubing which may be cut to length



OM041R, TA005771

1/2



OM047R

1/2

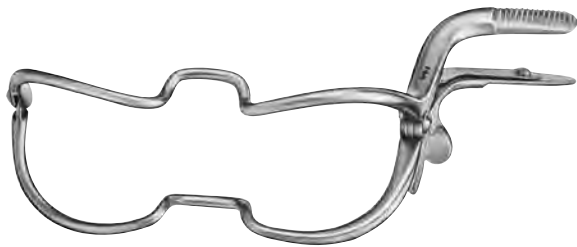

OM070R-OM073R



OP299

DOYEN-JANSEN Mouth Gag

Catalog Number	Description	Length (in.)	Length (m)
OM041R	-	5 1/2	-
TA005771	SPARE SILICONE TUBE ONLY, LATEX-FREE	-	1

TA005771 Protective covers for OM041R available as silicone tubing which may be cut to length

DENHARDT Mouth Gag

Catalog Number	Length (in.)
OM047R	5

WHITEHEAD-JENNINGS Mouth Gag

Catalog Number	Length (in.)
OM070R	3 1/2
OM071R	4 1/4
OM072R	5 1/8
OM073R	6

Teeth Protector, Latex-Free Rubber

Catalog Number	Size
OP299	ADOLESCENT AND ADULT



MA307R



MA304R



MA305R



MA306R



MA308R

DAVIS Mouth Gag

Catalog Number	Blade Size (mm)	Size (#)	Description	Length (in.)
MA302R	-	-	COMPLETE SET, RIGHT	-
MA303R	-	-	COMPLETE SET, LEFT	-
MA307R	-	-	RIGHT FRAME ONLY	6
MA304R	20 x 34	1	BLADE	5 1/4
MA305R	23 x 64	2	BLADE	5 1/4
MA306R	25 x 79	3	BLADE	5 1/4
MA308R	25 x 85	3 1/2	BLADE	5 1/8
MA309R	25 x 95	4	BLADE	5 1/8
MA310R	25 x 106	5	BLADE	5 1/8
OM170	SILICONE INSERT			

MA302R Includes:

1 Blades w/ Tube of each MA304R, MA307R, OM112R, MA315R, OM114R, OM115R

MA303R Includes:

1 Blades w/ Tube of each OM116R, MA304R, OM112R, MA315R, OM114R, OM115R



MA309R



MA310R

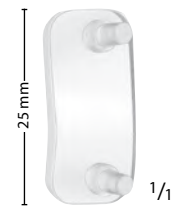

OM170



MA315R



MA319R

DAVIS Mouth Gag W/ Tube

Catalog Number	Blade Size (mm)	Size (#)
MA315R	24 x 80	3
MA319R	25 x 90	3

DAVIS-BOYLE Mouth Gag

Catalog Number	Blade Size (mm)	Size	Description	Length (in.)
OM118R	-	CHILD	FRAME ONLY	5 1/4
OM119R	-	TEEN	FRAME ONLY	5 3/4
OM116R	-	ADULT	FRAME ONLY	6 3/4
OM112R	25 x 62	-	BLADE	-
OM113R	25 x 75	-	BLADE	-
OM114R	25 x 92	-	BLADE	-
OM115R	25 x 108	-	BLADE	-
OM170	SILICONE INSERT			



OM118R



OM119R



OM116R



OM112R-OM115R

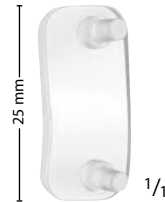

OM170

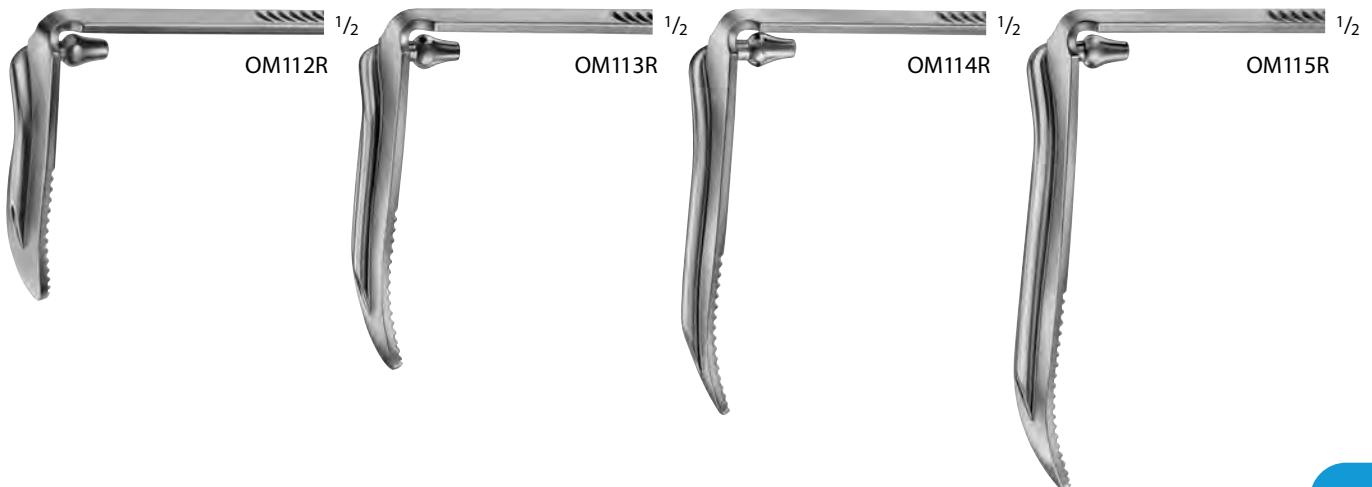

OM112R

OM113R

OM114R

OM115R

DAVIS-MEYER Tongue Depressor Frame

Catalog Number	Description
OM169R	FRAME, COMPLETE
OM170	SILICONE INSERT
OM179R	PALATE BLADE



OM169R

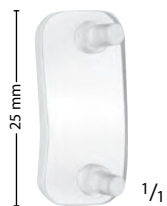

OM170



OM179R

MCIVOR Mouth Gag

Catalog Number	Blade Size (mm)	Size (#)	Description	Length (in.)
MA311R	-	-	COMPLETE WITH FRAME AND 3 TONGUE BLADES	-
MA312R	22 x 69	1	BLADE	5 3/8
MA313R	24 x 90	2	BLADE	5 3/8
MA314R	25 x 100	3	BLADE	5 3/8
OM104R	-	-	FRAME F/ TONGUE DEPRESSOR	5 1/2
OM104201	-	-	REPLACEMENT TUBE F/ OM104R	-
OM101R	25 x 55	-	BLADE	-
OM102R	25 x 62	-	BLADE	-
OM103R	25 x 75	-	BLADE	-
MB595R	57 x 23	2	BLADE, RIGHT	-
MB596R	72 x 27	3	BLADE, RIGHT	-
MB597R	88 x 33	4	BLADE, RIGHT	-
MB598R	57 x 23	2	BLADE, LEFT	-
MB599R	72 x 27	3	BLADE, LEFT	-
MB600R	88 x 33	4	BLADE, LEFT	-
MA301R	97 x 36	5	BLADE, LEFT	-
MA300R	97 x 36	5	BLADE, RIGHT	-

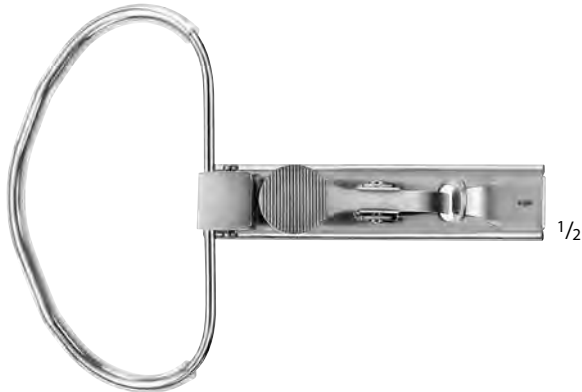

MA311R



MA312R-MA314R



OM104R



OM101R-OM103R



MB595R-MB600R



MA300R-MA301R

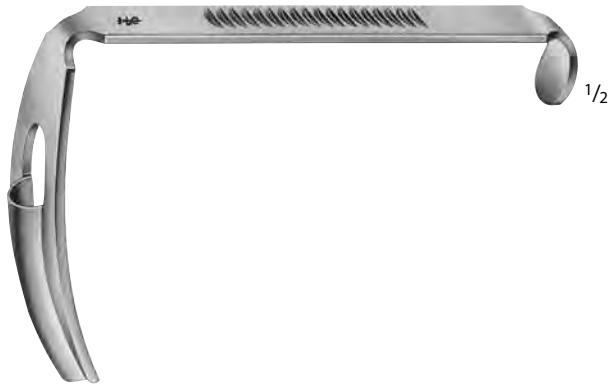

OM171R-OM178R

RUSSEL-DAVIS Tongue Blade

Catalog Number	Blade Size (mm)
OM171R	29 x 67
OM172R	33 x 75
OM173R	38 x 85
OM174R	40 x 92
OM175R	46 x 100
OM176R	18 x 57
OM177R	22 x 67
OM178R	25 x 75



OM171R



OM172R



OM173R



OM174R



OM175R



OM176R



OM177R



OM178R



OM181R-OM183R

GAST Tongue Blade

Catalog Number	Blade Size (mm)
OM181R	28 x 64
OM182R	34 x 74
OM183R	38 x 87



OM181R



OM182R



OM183R

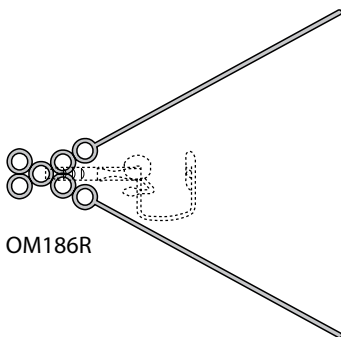

OM186R

DRAFFIN Chest Support, W/ 4 Height Rings

Catalog Number	Length (in.)
OM186R	18 7/8

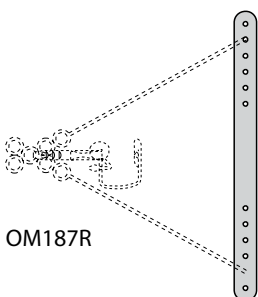

OM187R

MAGAURAN Plate, F/ Holding OM186R

Catalog Number	Length (in.)
OM187R	16



OM681R



OM681R

ABRAHAM Tonsil Knife

Catalog Number	Length (in.)
OM681R	8 3/4



OM688R



OM688R

FISHER Tonsil Knife

Catalog Number	Length (in.)
OM688R	8



ANDREWS Pynchon Suction Tube

Catalog Number	Description	Length (in.)
MD613	-	9
MD613001	TIP ONLY F/ MD613	-

MD613



MD613001



Suction Tube, W/ Finger Cut-Off

Catalog Number	Tip Size (mm)	Working Length (in.)
OP360R	2.0	9 3/4
OP361R	2.5	9 3/4
OP362R	3.0	9 3/4

OP360R-OP362R

Olive
 Diam. 6 - 9 mm

JACKSON Velvet Eye Aspirating Tube

Catalog Number	Diameter (mm)	Length (in.)
MB366R	4.0	10
MB367R	4.0	16 3/8
MB368R	4.0	22
MB369R	4.0	18 1/8



MB366R-MB369R



OM471R-OM474R

BARNHILL Adenoid Curette

Catalog Number	Tip Size (mm)	Length (in.)
OM471R	11	7 7/8
OM472R	13	7 7/8
OM473R	15	7 7/8
OM474R	17	7 7/8

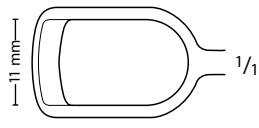

OM471R

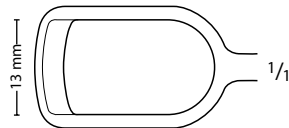

OM472R

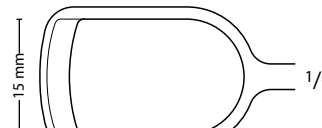

OM473R

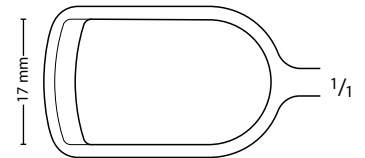

OM474R



OM451R-OM456R

BECKMANN Adenoid Curette

Catalog Number	Tip Size (mm)	Length (in.)
OM451R	9.25	7 7/8
OM452R	11.5	7 7/8
OM453R	12	7 7/8
OM454R	13	7 7/8
OM455R	15.5	7 7/8
OM456R	16	7 7/8
OM500R	10	8 3/4
OM501R	12	8 3/4
OM502R	14	8 3/4
OM503R	16	8 3/4
OM504R	18	8 3/4
OM505R	20	8 3/4

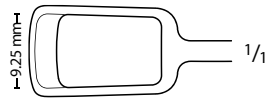

OM451R

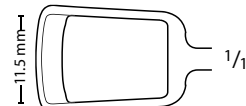

OM452R

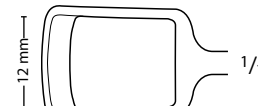

OM453R

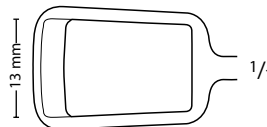

OM454R

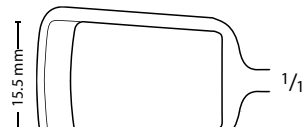

OM455R

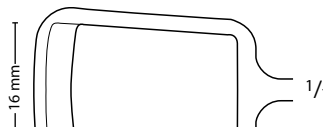

OM456R



OM500R-OM505R



OM500R



OM501R



OM502R



OM503R



OM504R



OM505R



MA654R-MA656R

JONES Adenoid Curette

Catalog Number	Tip Size (mm)	Size (#)	Size	Length (in.)
MA656R	4	1	INFANT	8 3/4
MA655R	6	2	CHILD	8 7/8
MA654R	8	3	ADULT	8 7/8



MA656R



MA655R



MA654R



MA291R

MIDDLETON Adenoid Curette

Catalog Number	Tip Size (mm)	Length (in.)
MA291R	7	8 7/8



MA291R



OM510R-OM514R

NEGUS Adenoid Curette

Catalog Number	Tip Size (mm)	Length (in.)
OM510R	10	7 7/8
OM511R	12.25	7 7/8
OM512R	14	7 7/8
OM513R	16.5	7 7/8
OM514R	18	7 7/8

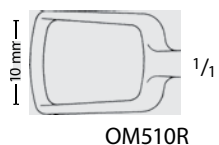

OM510R

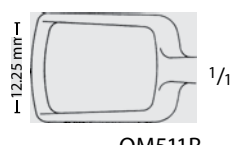

OM511R

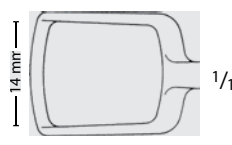

OM512R

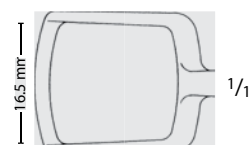

OM513R

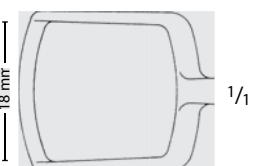

OM514R



US149-US150

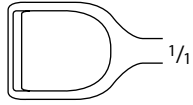

US149

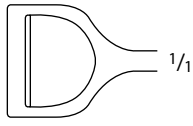

US150



MA066R-MA067R

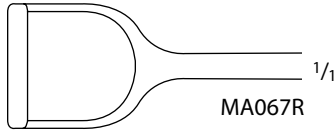

MA067R

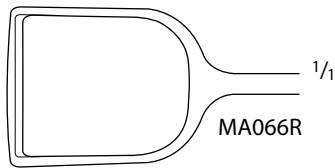

MA066R



MB316R



MB316R

STUBBS Adenoid Curette

Catalog Number	Tip Size (mm)	Size (#)	Length (in.)
US149	11	0	8 1/2
US150	14	1	8 1/2
MA067R	16	2	8 1/2
MA066R	18	3	8 1/2

VOGEL Adenoid Curette, Infant

Catalog Number	Tip Size (mm)	Length (in.)
MB316R	7	8 1/2

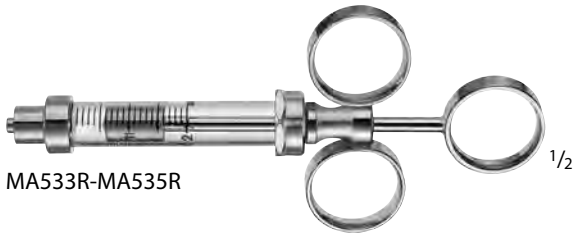

Syringe

Catalog Number	Diameter (mm)	Volume (cc)	Length (in.)
MA533R	11	3	5 1/2
MA534R	14	5	5 1/2
MA535R	17	10	5 1/2



OM078R-OM090R

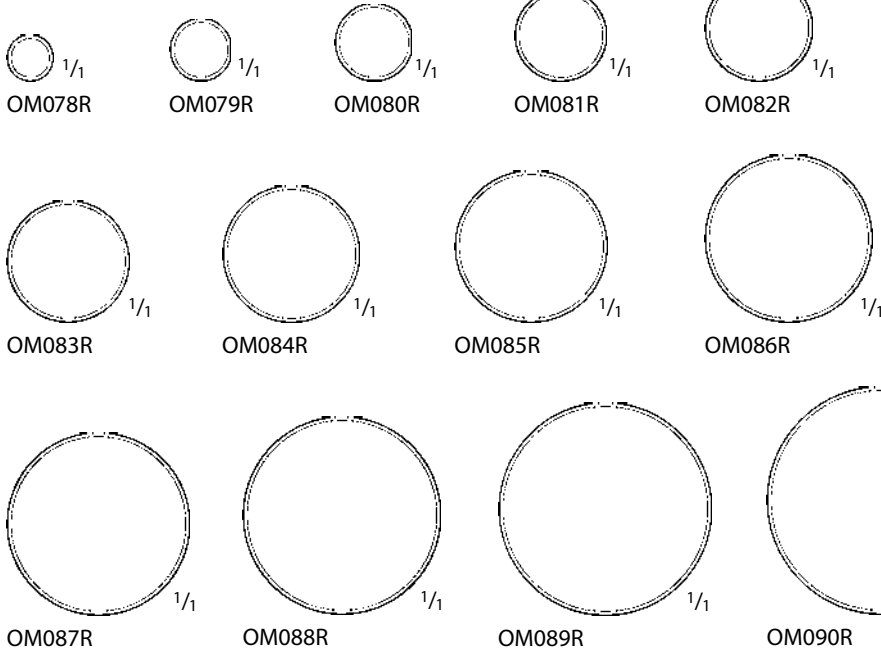

Laryngeal Mirror, Rigid, W/ Hex Handle

Catalog Number	Size (#)	Diameter (mm)	Length (in.)
OM078R	000	6.0	7
OM079R	00	8.0	7
OM080R	0	10.0	7
OM081R	1	12.0	7
OM082R	2	14.0	7
OM083R	3	16.0	7
OM084R	4	18.0	7
OM085R	5	20.0	7
OM086R	6	22.0	7
OM087R	7	24.0	7
OM088R	8	26.0	7
OM089R	9	28.0	7
OM090R	10	30.0	7



AC468R-AC480R



AC481R

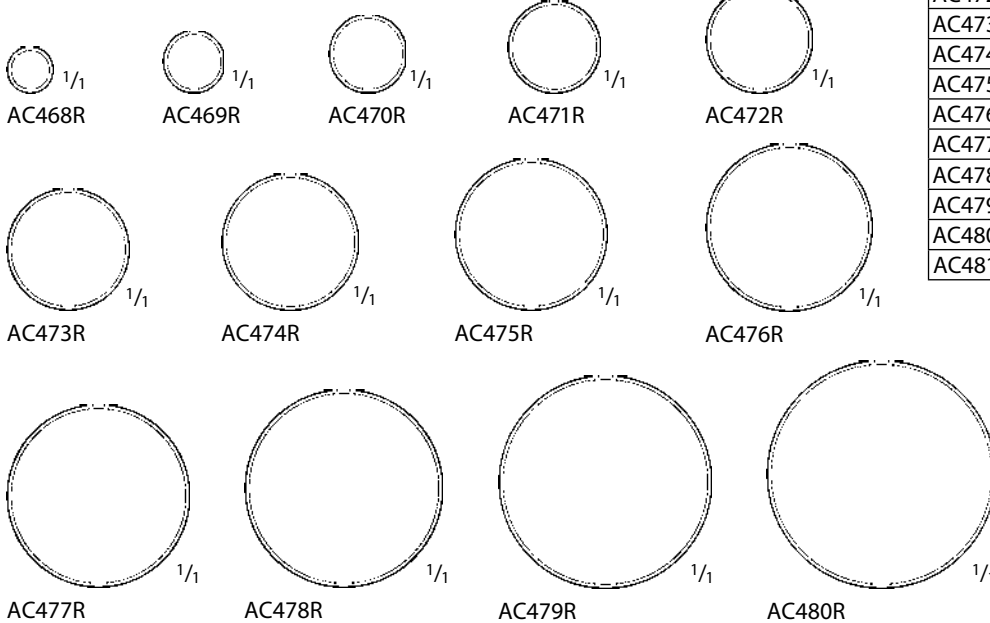

Laryngeal Mirror, Rigid, F/ Handle
AC481R

Catalog Number	Size (#)	Diameter (mm)	Length (in.)
AC468R	000	6.0	4 3/4
AC469R	00	8.0	4 3/4
AC470R	0	10.0	4 3/4
AC471R	1	12.0	4 3/4
AC472R	2	15.0	4 3/4
AC473R	3	16.0	4 3/4
AC474R	4	18.0	4 3/4
AC475R	5	20.0	4 3/4
AC476R	6	22.0	4 3/4
AC477R	7	24.0	4 3/4
AC478R	8	26.0	4 3/4
AC479R	9	28.0	4 3/4
AC480R	10	30.0	4 3/4
AC481R	-	HANDLE	4 1/4

Amalgam Carrier, Double Ended

Catalog Number	Size	Length (in.)
MG574R	MEDIUM / LARGE	7 7/8





Plastic Surgery

Scissors	748 - 768
Needle Holders	768 - 772
Forceps	773 - 782
Hooks and Retractors	783 - 793
Aluminum Hand	794
Knives	795 - 797
Suction Instruments	798
Bone Instruments	799 - 807
Micro Vessel Clips and Clamps	808 - 810

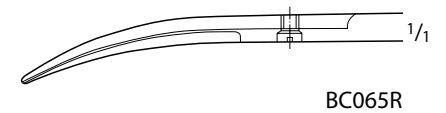
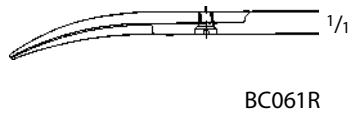
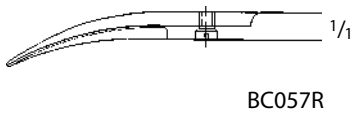
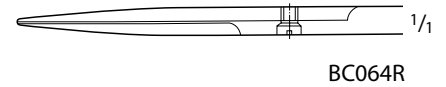
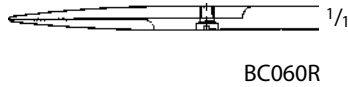
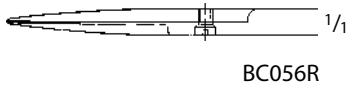
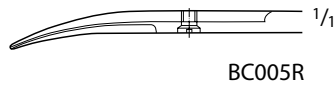
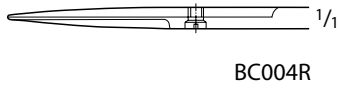
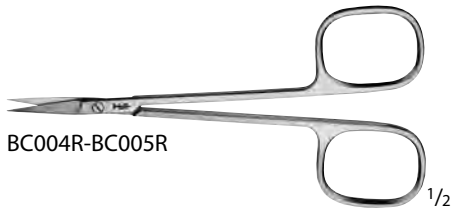

Iris Scissors, Delicate

Catalog Number	Tip	Blade	Handle	Length (in.)
BC004R	S/S	STR	SQUARE	4 1/2
BC005R	S/S	CVD	SQUARE	4 1/2
BC056R	S/S	STR	ROUND	3 3/4
BC060R	S/S	STR	ROUND	4 1/8
BC064R	S/S	STR	ROUND	4 3/4
BC057R	S/S	CVD	ROUND	3 3/4
BC061R	S/S	CVD	ROUND	4 1/8
BC065R	S/S	CVD	ROUND	4 3/4

Iris Scissors, Ribbon Handle

Catalog Number	Tip	Blade	Length (in.)
MB605R	S/S	STR	4
BC190R	S/S	CVD	4



Suture Scissors

Catalog Number	Tip	Blade	Length (in.)
BC130R	S/S	STR	4 3/4
BC140R	S/S	STR	5 1/8
BC144R	B/B	STR	5 1/8
BC135R	B/B	CVD, DEL	4 3/4
BC131R	S/S	CVD	4 3/4
BC141R	S/S	CVD	5 1/8
BC145R	B/B	CVD	5 1/8

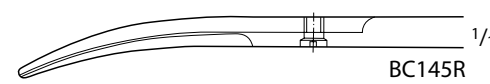
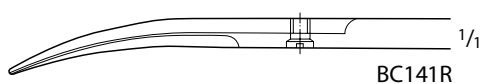
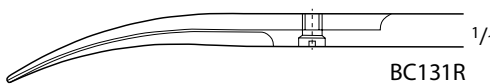
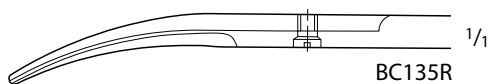
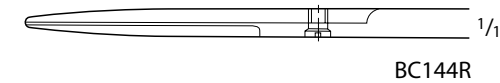
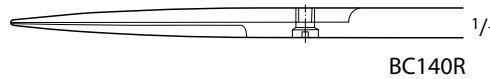
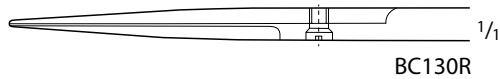

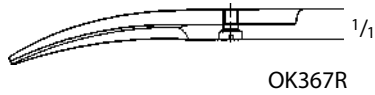
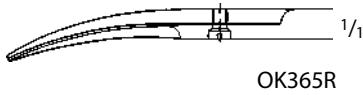

COTTLE-MASING Plastic Scissors

Catalog Number	Tip	Blade	Length (in.)
OK365R	S/S	CVD	4 1/8
OK367R	B/B	CVD	4 1/8

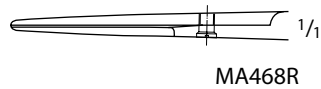
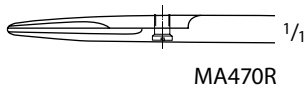
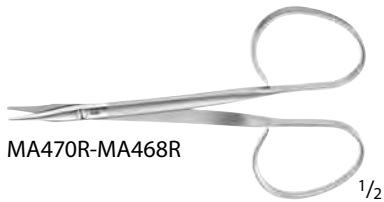

STEVENS Tenotomy Scissors

Catalog Number	Tip	Blade	Handle	Weight	Length (in.)
MA470R	B/B	STR	RIBBON	LIGHT	3 3/4
MA468R	B/B	STR	RIBBON	HEAVY	3 7/8
MA469R	B/B	CVD	RIBBON	HEAVY	3 3/4

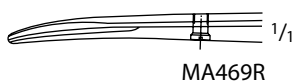

STEVENS Tenotomy Scissors
 (continued)

Catalog Number	Tip	Blade	Handle	Length (in)
BC008R	S/S	STR	SQUARE	4 1/2
BC010R	B/B	STR	SQUARE	4 1/2
BC009R	S/S	CVD	SQUARE	4 1/2
BC011R	B/B	CVD	SQUARE	4 1/2
BC170R	S/S	STR	ROUND	4 1/4
BC172R	B/B	STR	ROUND	4 1/4
MA467R	B/B	STR	ROUND	5 3/4
BC171R	S/S	CVD	ROUND	4 1/4
BC173R	B/B	CVD	ROUND	4 1/4
MA466R	B/B	CVD	ROUND	5 3/4

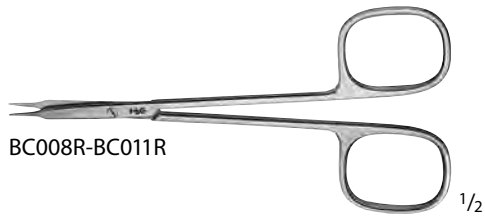

BC008R-BC011R

1/2

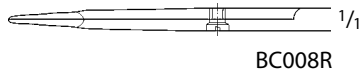

BC008R

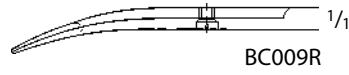

BC009R

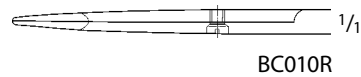

BC010R

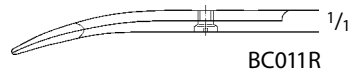

BC011R

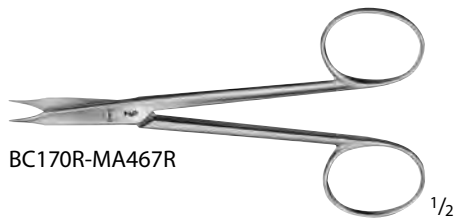

BC170R-MA467R

1/2

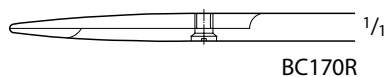

BC170R

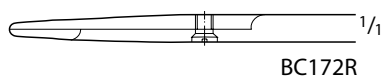

BC172R

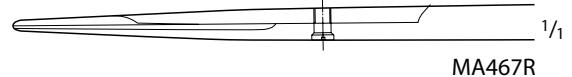

MA467R

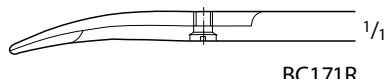

BC171R

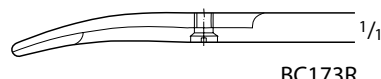

BC173R

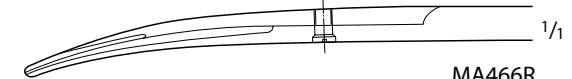

MA466R



STEVENS Tenotomy Scissors, Delicate

Catalog Number	Tip	Blade	Length (in.)
BC194R	B/B	STR	5
BC195R	B/B	CVD	5

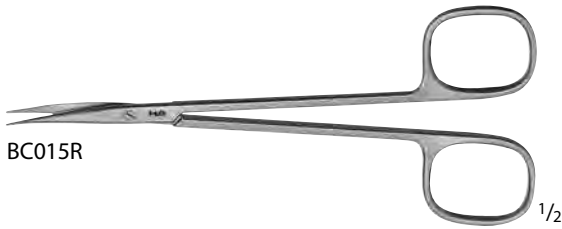
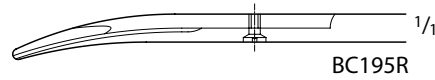
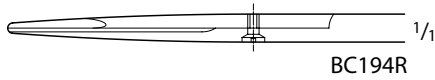

REYNOLDS-JAMESON Tenotomy Scissors, Delicate

Catalog Number	Tip	Blade	Handle	Length (in.)
BC015R	B/B	CVD	SQUARE	5 1/2

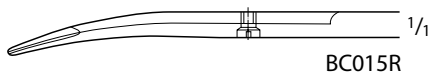

REYNOLDS Tenotomy Scissors, Delicate

Catalog Number	Tip	Blade	Length (in.)
BC180R	B/B	CVD	5 3/4
BC181R	B/B	CVD	6 7/8

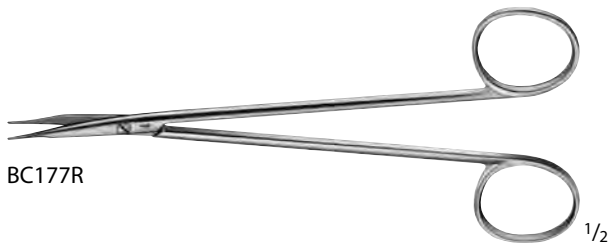
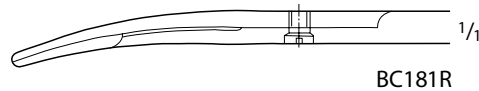
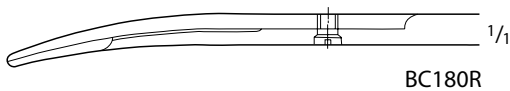

JAMESON Tenotomy Scissors, Delicate

Catalog Number	Tip	Blade	Length (in.)
BC177R	B/B	CVD	6

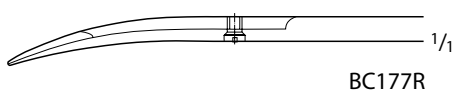

JAMESON SuperCut Scissors, Delicate

Catalog Number	Tip	Blade	Length (in.)
BC911R	B/B	CVD	5 1/8
BC915R	B/B	CVD	6
BC919R	B/B	CVD	7



BC911R, BC915R, BC919R



BC911R



BC915R

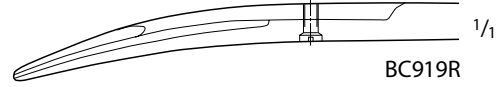

BC919R

POTTS Tenotomy Scissors

Catalog Number	Tip	Blade	Length (in.)
BC178R	B/B	CVD	6 7/8
BC179R	B/B	CVD	8

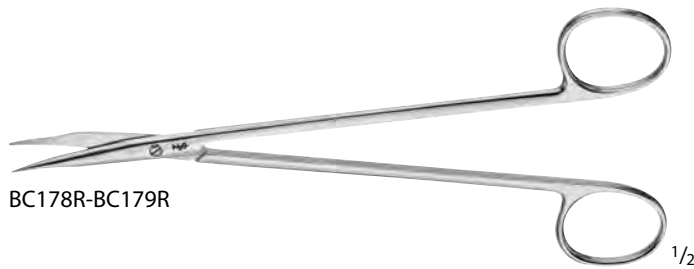

BC178R-BC179R



BC178R



BC179R

Nerve Dissecting Scissors

Catalog Number	Tip	Blade	Length (in.)
BC628R	S/S	CVD	6

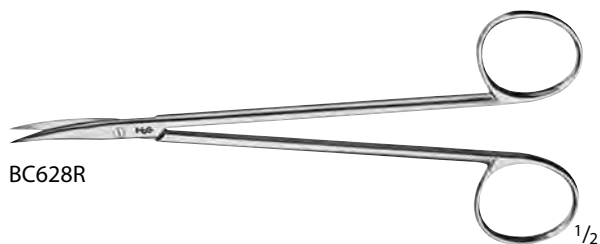

BC628R

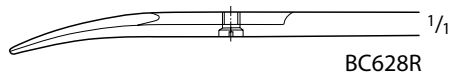

BC628R



JOSEPH Scissors, Delicate

Catalog Number	Tip	Blade	Handle	Length (in.)
BC006R	S/S	STR	SQUARE	6
BC007R	S/S	CVD	SQUARE	6
BC156R	S/S	STR	ROUND	6
BC157R	S/S	CVD	ROUND	6

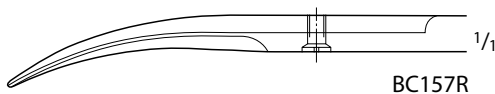
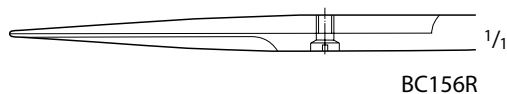
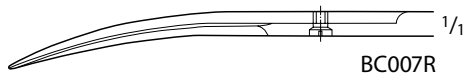
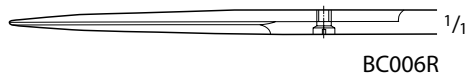

KILNER Scissors

Catalog Number	Tip	Blade	Length (in.)
BC162R	S/S	STR	4 1/2
BC166R	FLAT	CVD	5
BC168R	FLAT	CVD	6

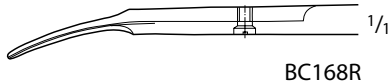
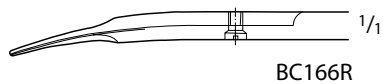
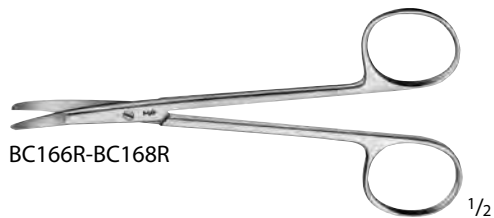
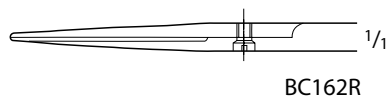

Strabismus Scissors

Catalog Number	Tip	Blade	Length (in.)
BC164R	B/B	STR	4 1/2
BC165R	B/B	CVD	4 1/2

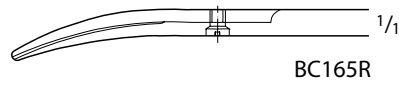
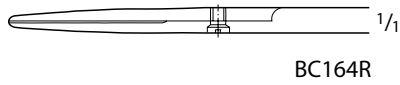

LITTLER Scissors

Catalog Number	Tip	Blade	Length (in.)
BC163R	W/EYE	CVD	4 1/2

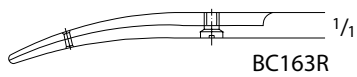

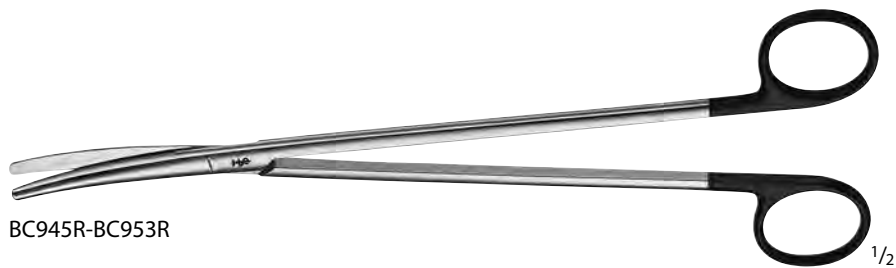

BC945R-BC953R

METZENBAUM SuperCut Scissors

Catalog Number	Tip	Blade	Length (in.)
BC945R	B/B	CVD	9
BC947R	B/B	CVD	10 1/4
BC949R	B/B	CVD	11 1/4
BC951R	B/B	CVD	11 3/4
BC953R	B/B	CVD	14



BC945R



BC947R

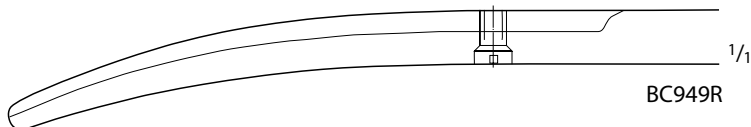

BC949R

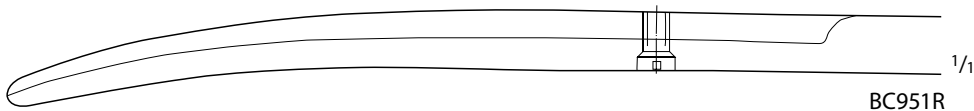

BC951R

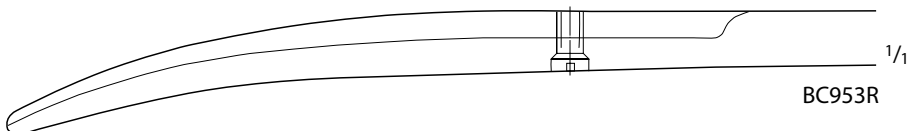

BC953R

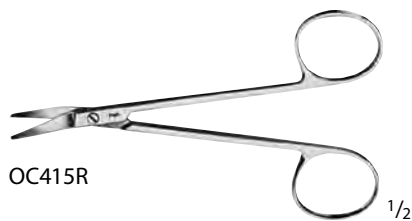

OC415R

GRAEFE Scissors

Catalog Number	Tip	Blade	Length (in.)
OC415R	B/B	LAT-ANG	4

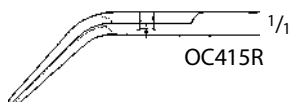

OC415R

FOMON Lower Lateral Scissors

Catalog Number	Tip	Blade	Length (in.)
OK373R	B/B	HEAVY-CVD	4 1/2
OK372R	B/B	HEAVY-CVD	5 1/4

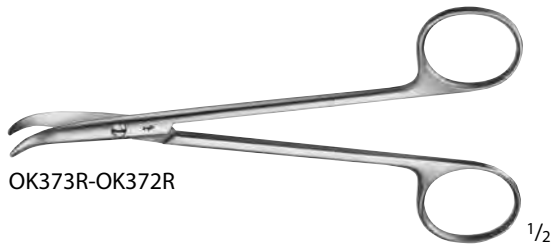

OK373R-OK372R

1/2

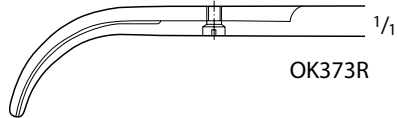

OK373R

1/1

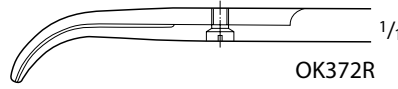

OK372R

1/1



BC801R-BC802R

1/2

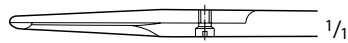

BC801R

1/1



BC802R

1/1

SPENCER Suture Scissors

Catalog Number	Blade	Length (in.)
BC801R	STR	3 1/2
BC802R	STR	4 1/2



BC803R

1/2



BC803R

1/1

LITTAUER Ligature Scissors

Catalog Number	Blade	Length (in.)
BC803R	STR	5 1/4



BC805R

1/2



BC805R

1/1

NORTHBENT Ligature Scissors

Catalog Number	Tip	Blade	Length (in.)
BC805R	B/B	LAT-CVD	4 3/4



BC672R

1/2



BC672R

1/1

Cartilage Scissors

Catalog Number	Tip	Blade	Length (in.)
BC672R	S/S	SERR	7 1/4



MA458R-MB109R

1/2

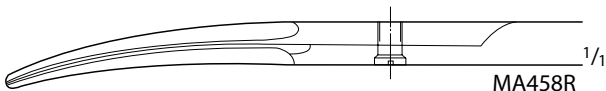

MA458R

1/1



MB109R

1/1

KAYE Facelift Scissors

Catalog Number	Tip	Blade	Length (in.)
MA458R	SEMI-SHARP	CVD, SERR	6
MB109R	SEMI-SHARP	CVD, SERR	7 1/2



MB150R

1/2

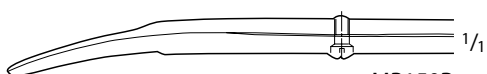

MB150R

1/1

METZENBAUM-LIPSETT Scissors

Catalog Number	Tip	Blade	Length (in.)
MB150R	B/B	CVD	5 1/2

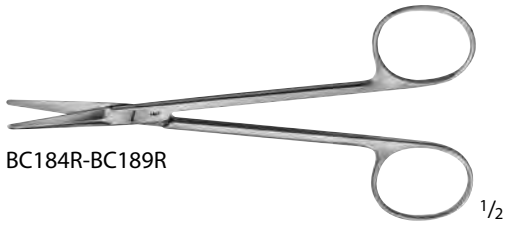

BC184R-BC189R

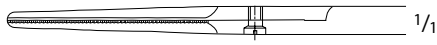

BC184R

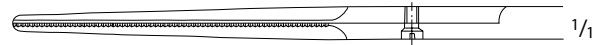

BC188R

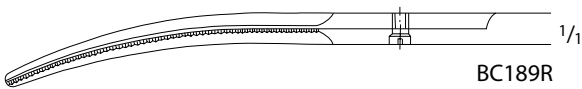

BC189R

GORNEY Scissors

Catalog Number	Tip	Blade	Length (in.)
BC184R	B/B	STR	5
BC188R	B/B	STR	7 3/4
BC189R	B/B	SLIGHT-CVD	7 3/4



MB632R

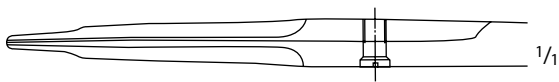

MB632R



MB633R

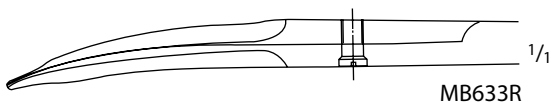

MB633R

GORNEY-FREEMAN SuperCut Scissors

Catalog Number	Tip	Blade	Length (in.)
MB632R	BEVELED BLUNT	STR	7 1/4
MB633R	BEVELED BLUNT	CVD	7 1/4

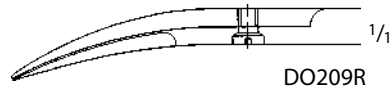
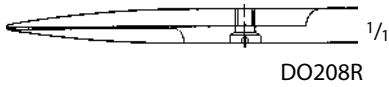
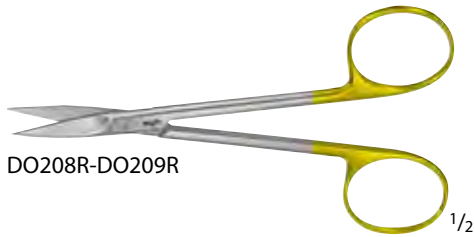

DUROTIP TC Delicate Scissors

Catalog Number	Tip	Blade	Length (in.)
DO208R	S/S	STR	4 3/4
DO209R	S/S	CVD	4 3/4

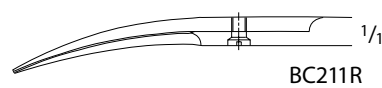
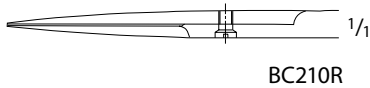

DUROTIP TC Iris Scissors, Delicate

Catalog Number	Tip	Blade	Length (in.)
BC210R	S/S	STR	4 1/4
BC211R	S/S	CVD	4 1/4



DUROTIP TC GOLDMAN-FOX Tenotomy Scissors, Delicate

Catalog Number	Tip	Blade	Length (in.)
DO250R	S/S	CVD, 1/SERR	5 1/8

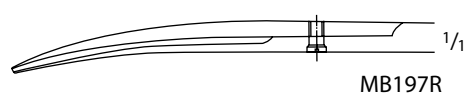

DUROTIP TC Par Scissors

Catalog Number	Tip	Length (in.)
MB198R	CVD, BLUNT	4 1/2
MB197R	CVD, BLUNT	5 3/4

DUROTIP TC GORNEY-FREEMAN
Facelift Scissors

Catalog Number	Blade	Length (in.)
MB648R	STR, SERR	7 3/4
MB649R	CVD, SERR	7 3/4

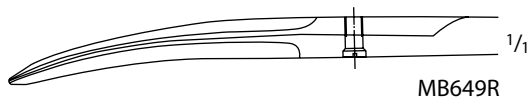
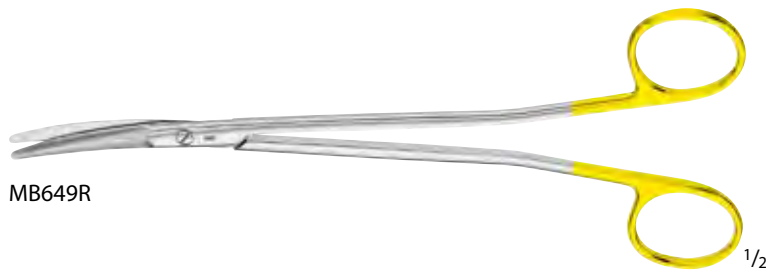
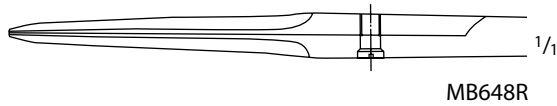

Wavecut

Wavecut scissors have one serrated cutting edge to help prevent tissue from slipping. The W after the item number indicates the scissors are the wavecut style, e.g. BC211W.

DUROTIP TC Iris Scissors, Wavecut

Catalog Number	Tip	Blade	Length (in.)
BC211W	S/S	CVD	4 1/4

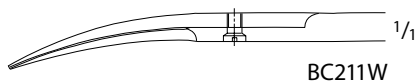
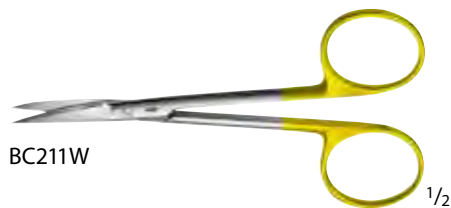



BC259W

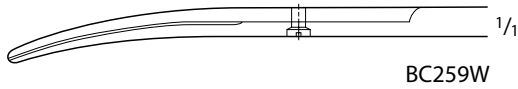

BC259W

**DUROTIP TC Baby METZENBAUM
Wavecut Dissecting Scissors, Delicate**

Catalog Number	Tip	Blade	Length (in.)
BC259W	B/B	CVD	5 3/4

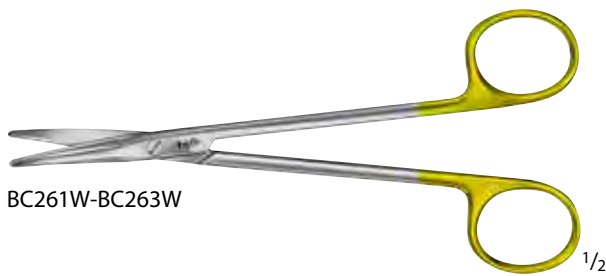

BC261W-BC263W

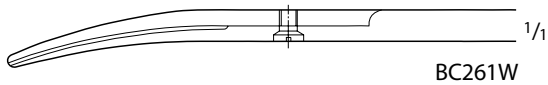

BC261W

**DUROTIP TC METZENBAUM
Wavecut Dissecting Scissors**

Catalog Number	Tip	Blade	Length (in.)
BC261W	B/B	CVD	5 3/4
BC263W	B/B	CVD	7

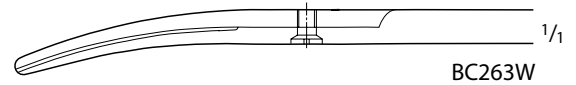

BC263W

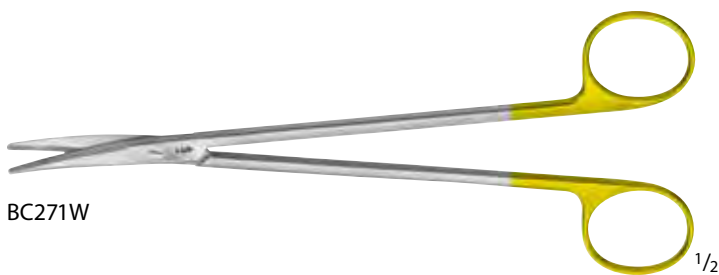

BC271W

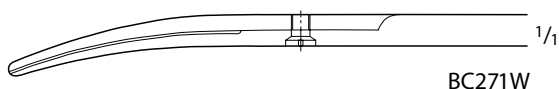

BC271W

**DUROTIP TC METZENBAUM
Wavecut Delicate Scissors**

Catalog Number	Tip	Blade	Length (in.)
BC271W	B/B	CVD	7

SuperCut Scissors, Delicate

Catalog Number	Tip	Blade	Length (in.)
BC903R	S/S	CVD	5

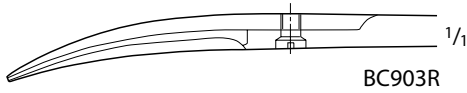

GOLDMANN-FOX SuperCut Scissors,
 Delicate

Catalog Number	Tip	Blade	Length (in.)
BC909R	S/S	CVD	5 1/8

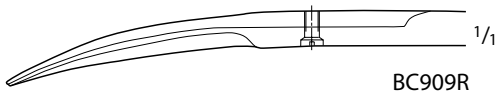



BC920R-BC921R

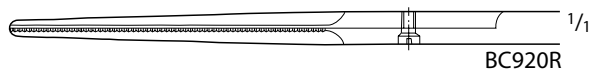

BC920R

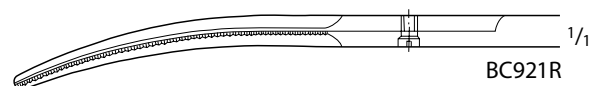

BC921R

GORNEY SuperCut Scissors, Delicate

Catalog Number	Tip	Blade	Length (in.)
BC920R	B/B	STR	7 3/4
BC921R	B/B	CVD	7 3/4



BC933R

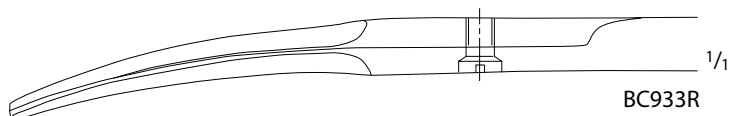

BC933R

KAYE SuperCut Scissors, Delicate

Catalog Number	Blade	Length (in.)
BC933R	CVD	7 3/4



BC939R

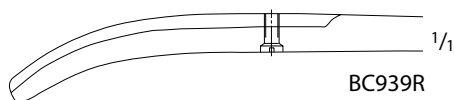

BC939R

FOMON SuperCut Scissors

Catalog Number	Tip	Blade	Length (in.)
BC939R	B/B	CVD	4 1/2

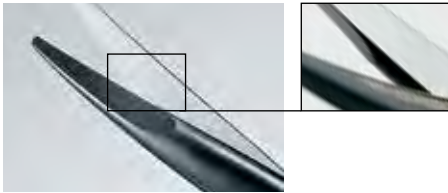

Microtome Edge

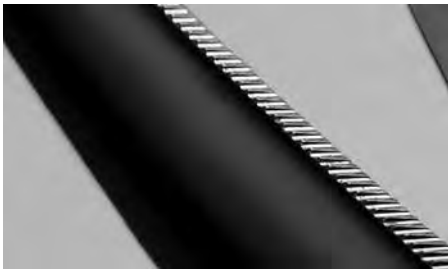

Wavecut

Noir Supreme Cut Scissors

- **Noir**
 The combination of the renowned Tungsten Carbide technology with the Noir coating results in an extremely high surface hardness and therefore high wear resistance in daily hospital use.
- **Microtome edge**
 The extremely sharp cutting edge of the scissors blade facilitates gentle cutting of tissue with minimal use of force.
- **Wavecut** helps prevent tissue from slipping out during the cutting process.
- The WB after the item number indicates the Noir scissors are the wavecut style, e.g. BC211WB.



Noir Iris Dissecting Scissors

Catalog Number	Tip	Blade	Length (in.)
BC210B	S/S	STR	4 1/4
BC211B	S/S	CVD	4 1/4
BC211WB	S/S	CVD	4 1/4



Noir Strabismus Dissecting Scissors

Catalog Number	Tip	Blade	Length (in.)
BC257B	B/B	CVD	4 1/2
BC257WB	B/B	CVD	4 1/2



Noir Baby METZENBAUM Dissecting Scissors

Catalog Number	Tip	Blade	Length (in.)
BC259B	B/B	CVD	5 3/4
BC259WB	B/B	CVD	5 3/4

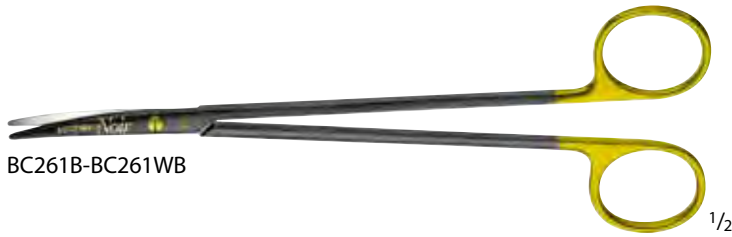

BC261B-BC261WB

1/2



BC261B-BC261WB

1/1

Noir METZENBAUM Dissecting Scissors

Catalog Number	Tip	Blade	Length (in.)
BC261B	B/B	CVD	5 3/4
BC261WB	B/B	CVD	5 3/4

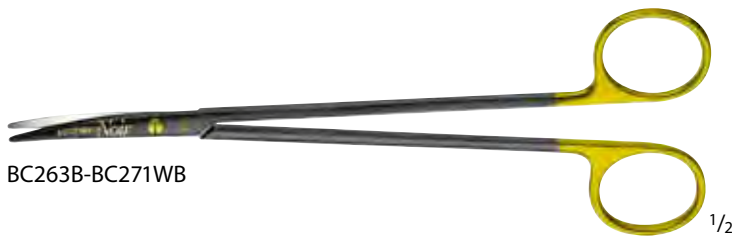

BC263B-BC271WB

1/2



BC263B, BC263WB

1/1



BC271B, BC271WB

1/1

Noir METZENBAUM Dissecting Scissors

Catalog Number	Tip	Blade	Length (in.)
BC263B	B/B	CVD	7
BC263WB	B/B	CVD	7
BC271B	B/B	CVD, DEL	7
BC271WB	B/B	CVD, DEL	7



BC273B-BC273WB

1/2



BC273B-BC273WB

1/1

Noir TOENNIS-ADSON Dissecting Scissors

Catalog Number	Tip	Blade	Length (in.)
BC273B	B/B	CVD, DEL	6 7/8
BC273WB	B/B	CVD, DEL	6 7/8



FM010R-FM040R

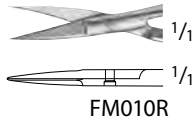

FM010R

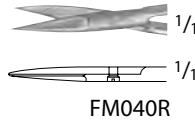

FM040R



FM011R-FM041R

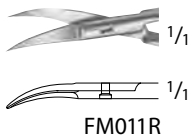

FM011R

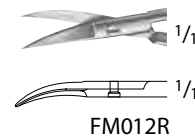

FM012R

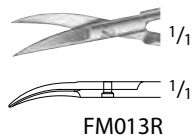

FM013R

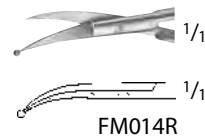

FM014R

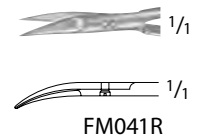

FM041R



FD251R-FD252R



FD252R

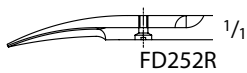

FD251R

MUELLER Micro Scissors

Catalog Number	Tip	Handle Color	Blade	Length (in.)
FM010R	S/S	BLUE	STR	4 3/4
FM040R	S/S	BLUE	STR	6 3/4
FM011R	S/S	BLUE	CVD	4 3/4
FM012R	S/B	BLUE	CVD	4 3/4
FM013R	B/B	BLUE	CVD	4 3/4
FM014R	S/BALL-PT	BLUE	CVD	4 3/4
FM041R	S/S	BLUE	CVD	6 3/4

Micro Scissors, Golf Ball Handle

Catalog Number	Blade	Length (in.)
FD252R	SLIGHT CVD, 1/SERR	7
FD251R	CVD	7

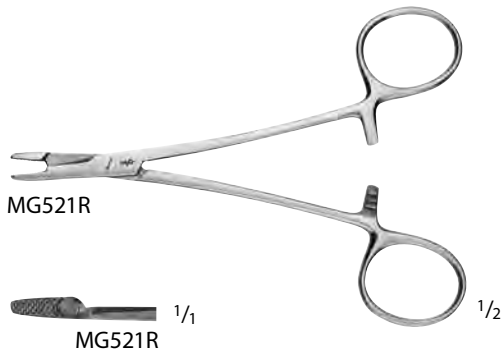
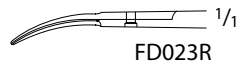
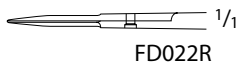

Micro Scissors, Golf Ball Handle

Catalog Number	Blade	Length (in.)
FM042R	STR	7
FM043R	CVD	7

YASARGIL Micro Vessel Scissors

Catalog Number	Blade	Handle	Length (in.)
FD022R	STR	FLAT, SERR	7 1/4
FD023R	CVD	FLAT, SERR	7 1/4

HEGAR-OLSEN Needle Holder

Catalog Number	Tip	Length (in.)
MG521R	SERR	4 3/4

features Needle Holders with Tungsten Carbide (TC) inserts.

A smooth jaw and three different serration patterns are available, depending on the size of the suture needle.

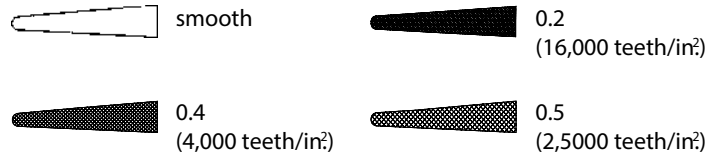

We recommend carbide inserts as follows:

Jaw Surface	Suture Material
Smooth	9/0 - 11/0
0.2 mm pitch of serration	6/0 - 10/0
0.4 mm pitch of serration	4/0 - 6/0
0.5 mm pitch of serration	up to 3/0

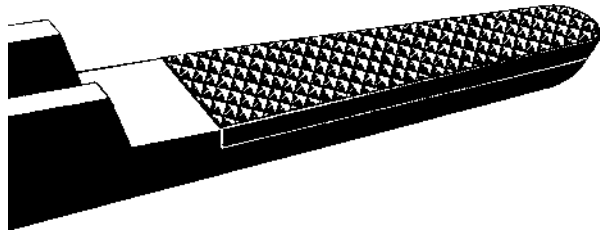

DUROGRIP TC CASTROVIEJO
 Micro Needle Holder, Flat Handle

Catalog Number	Jaw	Length (in.)
BM001R	SMOOTH	5 3/4
BM002R	SERR	5 3/4
BM004R	SERR	7
BM005R	SERR	8 1/2

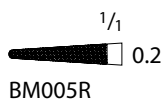
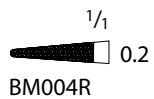
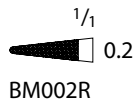
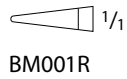



BM127R

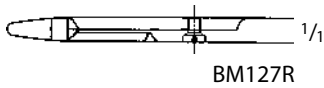

BM127R

DUROGRIP TC LEWIN Needle Holder/
 Scissors

Catalog Number	Jaw	Length (in.)
BM127R	SMOOTH	5

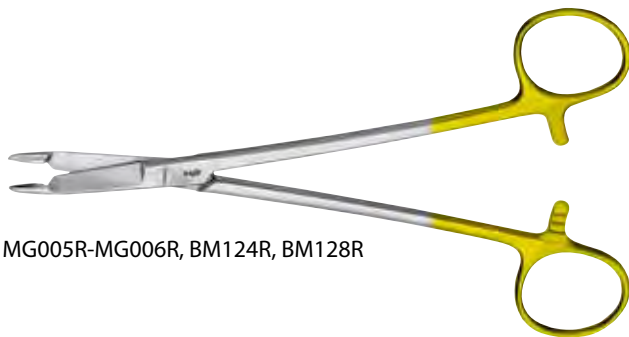

MG005R-MG006R, BM124R, BM128R

DUROGRIP TC HEGAR-OLSON
 Needle Holder/Scissors

Catalog Number	Jaw	Length (in.)
MG005R	SMOOTH	4 3/4
MG006R	SERR	4 3/4
BM128R	SERR	5 3/4
BM124R	SERR	6 1/2



MG005R



MG006R

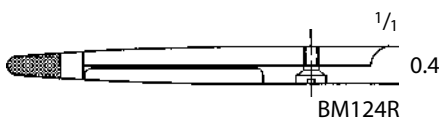

BM124R

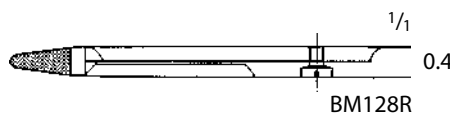

BM128R



BM129R

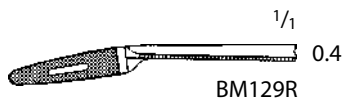
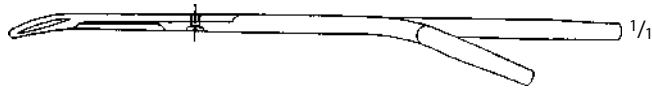

BM129R

DUROGRIP TC GILLIES Needle Holder/
 Scissors

Catalog Number	Jaw	Handle	Length (in.)
BM129R	SERR	OFF-SET	6 1/4

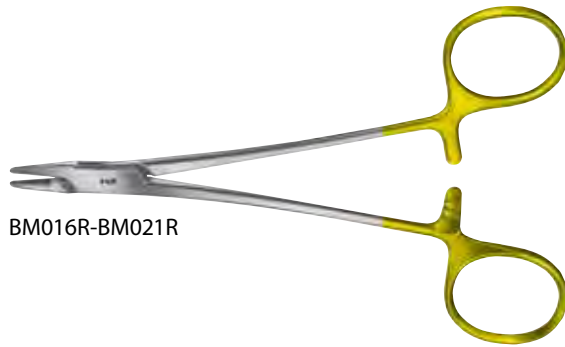

BM016R-BM021R

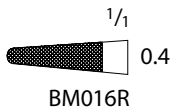

BM016R

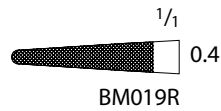

BM019R

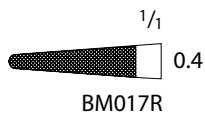

BM017R

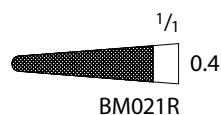

BM021R

DUROGRIP TC CRILE-WOOD
 Needle Holder

Catalog Number	Jaw	Length (in.)
BM016R	SERR	5 3/4
BM017R	SERR	7 1/4
BM019R	SERR	7 7/8
BM030R	SERR	10 5/8
BM021R	SERR	12

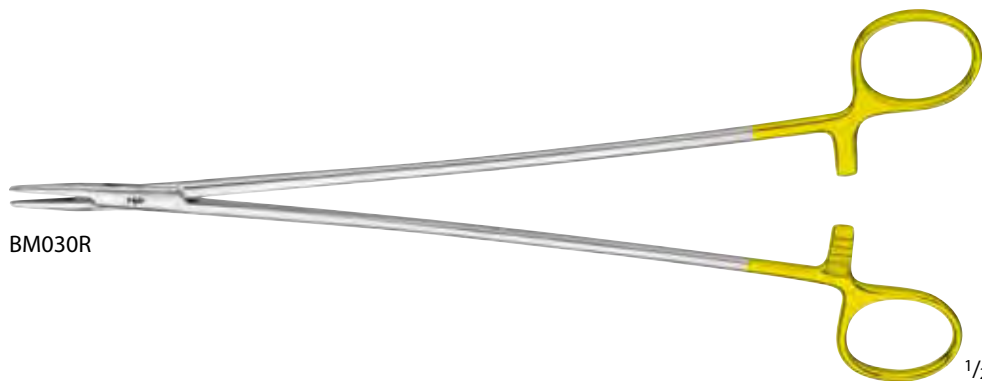

BM030R



BM030R

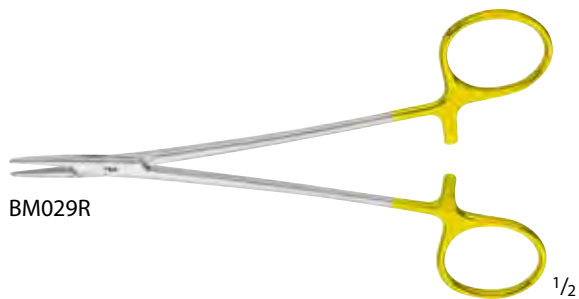

BM029R

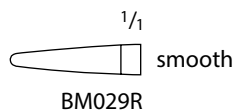

BM029R

DUROGRIP TC CRILE-WOOD
 Needle Holder

Catalog Number	Jaw	Length (in.)
BM029R	SMOOTH	6



MB295R



MB295R



MB294R



MB294R



BD505R



BD505R



BD329R



BD329R



BD330R



BD330R

CASTROVIEJO Suture Forceps

Catalog Number	Tip Size (mm)	Teeth	Length (in.)
MB295R	0.12	1 x 2	4 1/8

CASTROVIEJO COLIBRI Type Corneal Forceps

Catalog Number	Tip Size (mm)	Teeth	Length (in.)
MB294R	0.12	1 x 2	4 1/8

BONN Eye Forceps, W/ Platform

Catalog Number	Tip Size (mm)	Teeth	Length (in.)
BD505R	0.2	1 x 2	3 3/4

Jewelers Forceps

Catalog Number	Tip Size (mm)	Tip	Length (in.)
BD329R	0.3	ANG	4 1/4

Micro Forceps #4 Jewelers

Catalog Number	Tip Size (mm)	Length (in.)
BD330R	0.2	4 1/4



BD345R



BD345R



BD336R



BD336R



BD337R



BD337R



BD338R



BD338R



BD340R

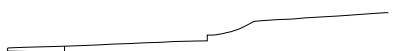

BD340R

Micro Jewelers Forceps

Catalog Number	Tip Size (mm)	Teeth	Length (in.)
BD345R	0.4	1 x 2	5 1/4

VISE Micro Suture Forceps

Catalog Number	Tip Size (mm)	Tip	Length (in.)
BD336R	0.3	STR	5 1/4
BD337R	0.3	CVD	5 1/4

Micro Suture Forceps, W/ Platform

Catalog Number	Tip Size (mm)	Length (in.)
BD338R	0.3	4 3/4

AUSTIN Micro Suture Forceps, W/ Platform

Catalog Number	Tip Size (mm)	Length (in.)
BD340R	0.8	5 1/2



FD284R-FD287R

Micro Suture Forceps, Round Handle

Catalog Number	Tip Size (mm)	Tip	Length (in.)
FD284R	0.3	STR	6
FD286R	0.5	STR	7
FD285R	0.3	CVD	6
FD287R	0.5	CVD	7

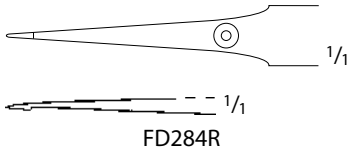

FD284R

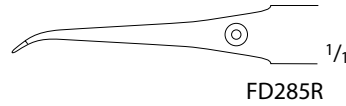

FD285R

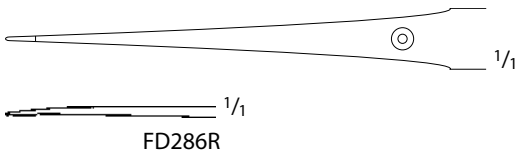

FD286R

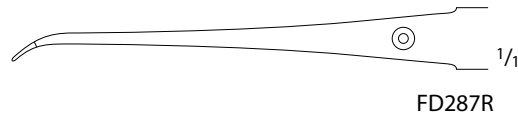

FD287R



BD509R

MICRO-ADSON-BIEMER Forceps

Catalog Number	Teeth	Length (in.)
BD509R	1 x 2	4 3/4

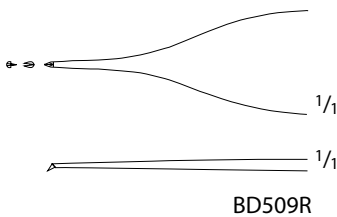

BD509R



FM001R-FM006R

MUELLER Micro Forceps

Catalog Number	Tip Size (mm)	Handle Color	Teeth	Length (in.)
FM001R	0.15	BROWN	-	4 1/4
FM002R	0.20	BROWN	-	4 1/4
FM003R	0.30	BROWN	-	4 1/4
FM004R	0.50	BLACK	1 x 2	4 1/4
FM005R	1.20	GREY	RING	4 1/4
FM006R	1.20	GREY	TRI	4 1/4

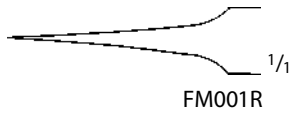

FM001R

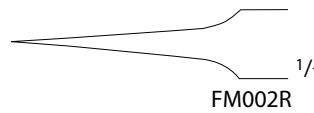

FM002R

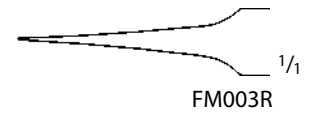

FM003R

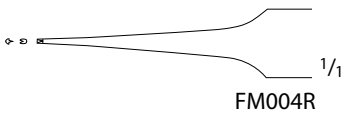

FM004R

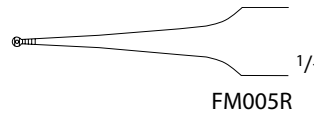

FM005R

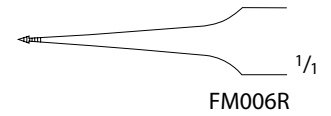

FM006R



BD260R

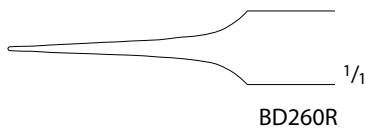

BD260R



BD261R

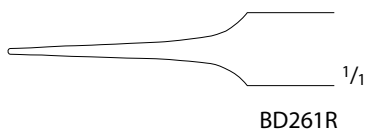

BD261R

LAZAR Micro Suture Forceps

Catalog Number	Tip Size (mm)	Length (in.)
BD260R	0.5	6 1/8
BD261R	0.8	6 1/8



HERZ Tendon Seizing Forceps

Catalog Number	Jaw	Length (in.)
BF303R	CVD	6 1/8



JACKSON Tendon Seizing Forceps

Catalog Number	Teeth	Length (in.)
BF306R	4 x 5	6 1/8



BUNNELL Tendon Passing Probe

Catalog Number	Length (in.)
MB363C	7 3/8
FO940R	9



BF307R

1/2

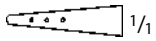

1/1



BF307R

1/1

Tendon Seizing Forceps, W/ 3 Pins

Catalog Number	Length (in.)
BF307R	4 3/4

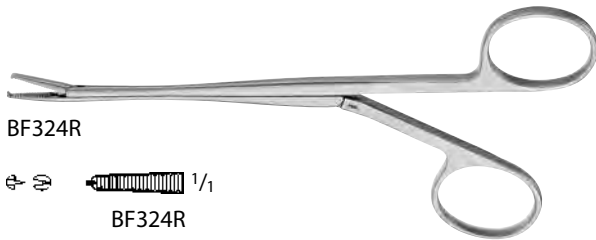

BF324R



1/1

BF324R



BF326R



1/1

BF326R

BRAND Tendon Holding Forceps

Catalog Number	Jaw	Teeth	Length (in.)
BF324R	STR	1 x 2	6
BF326R	STR	1 x 2	7 1/4
BF315R	CVD	1 x 2	6
BF316R	CVD	1 x 2	7 1/4



BF315R

1/2

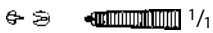

1/1

BF315R



BF316R



1/1

BF316R

KLEINERT-KUTZ Tendon Retriever

Catalog Number	Size	Shaft	Length (in.)
MG091R	-	FLEXIBLE	8
MB985R	SMALL	RIGID	8 1/4

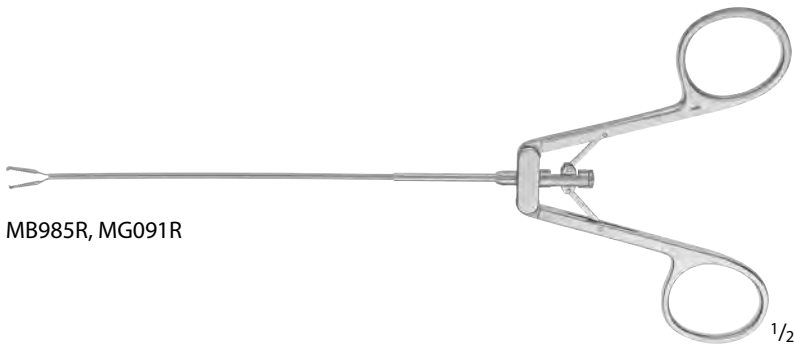

CARROLL Tendon Pulling Forceps

Catalog Number	Length (in.)
MB474R	6



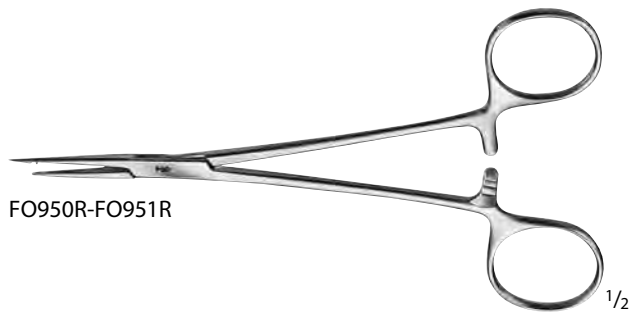

FO950R-FO951R

1/2

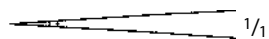

1/1

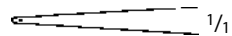

FO950R

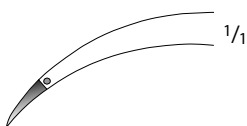

1/1

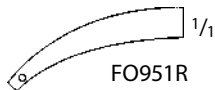

FO951R

Tendon Interlacing Forceps

Catalog Number	Jaw	Length (in.)
FO950R	STR	6
FO951R	CVD	6

Tendon Stripper

Catalog Number	Length (in.)
FO935R	11 3/4
FO939R	19 3/4



FO935R-FO939R

1/2



FO935R

1/1



1/1



FO939R

1/1



1/1



BD952R



BD952R



BD963R-BD965R



BD963R



BD964R



BD965R

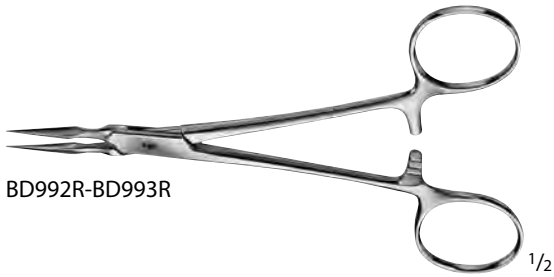

BD992R-BD993R



BD992R

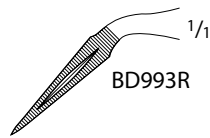

BD993R



BD995R

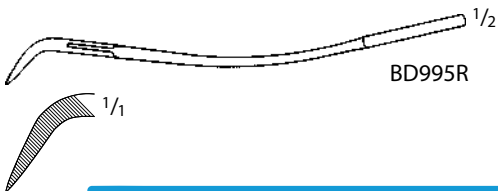

BD995R

Splinter Forceps

Catalog Number	Length (in.)
BD952R	3 1/8

FEILCHENFELD Splinter Forceps

Catalog Number	Length (in.)
BD963R	3
BD964R	3 3/4
BD965R	4 1/2

STIEGLITZ Splinter Forceps

Catalog Number	Jaw	Length (in.)
BD992R	STR	5 1/2
BD993R	CVD	5 1/2

PEET Splinter Forceps

Catalog Number	Length (in.)
BD995R	4 3/4



BH100R



BH100R

CARREL Artery Forceps

Catalog Number	Length (in.)
BH100R	3 1/4



BH139R-BH143R



BH139R



BH143R

DANDY Forceps

Catalog Number	Jaw	Jaw Shape	Length (in.)
BH139R	SERR	CVD	5 1/2
BH143R	1 x 2 Teeth	LAT-CVD	5 1/2



OA332R-OA333R



OA332R



OA333R



OA334R-OA335R



OA334R



OA335R



OA336R-OA338R



OA336R



OA337R



OA338R



OA340R

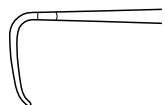

OA340R



OA351R



OA351R

GRAEFE Hook

Catalog Number	Tip	Length (in.)
OA332R	SHARP	5
OA333R	BLUNT	5

GUTHRIE Double Hook

Catalog Number	Tip	Length (in.)
OA334R	SHARP	5
OA335R	SHARP	5 1/8

ROLLET Hook Retractor

Catalog Number	Tip	Blade End	Length (in.)
OA336R	SHARP	2 PRONG	5 1/8
OA337R	SHARP	4 PRONG	5 1/4
OA338R	BLUNT	4 PRONG	5 1/4

PAUL Tendon Hook

Catalog Number	Tip	Blade End	Tip Size (mm)	Length (in.)
OA340R	BLUNT	3 PRONGS	11 x 8	4 3/4

JAEGER Hook Retractor, Fine

Catalog Number	Tip	Length (in.)
OA351R	SHARP	5 1/4



OL601R-OL603R



OL601R



OL602R



OL603R



OL610R



OL610R



OL611R-OL612R



OL611R



OL612R



OL619R



OL619R



OL617R



OL617R

KLEINERT-KUTZ Skin Hook

Catalog Number	Size	Tip	Tip Size (mm)	Length (in.)
OL601R	1	SHARP	2.5	6 1/4
OL602R	2	SHARP	4.2	6 1/4
OL603R	3	SHARP	4.8	6 1/4

KILNER Skin Hook

Catalog Number	Tip	Length (in.)
OL610R	SHARP	6 1/4

GILLIES Skin Hook

Catalog Number	Hook End	Tip	Length (in.)
OL611R	SMALL	SHARP	7
OL612R	LARGE	SHARP	7

COTTLE Hook

Catalog Number	Tip	Length (in.)
OL619R	CVD, SHARP	6 1/4
OL617R	ANG, SHARP	6 1/4



OL620R, MA185R, OL622R-OL624R, MD581

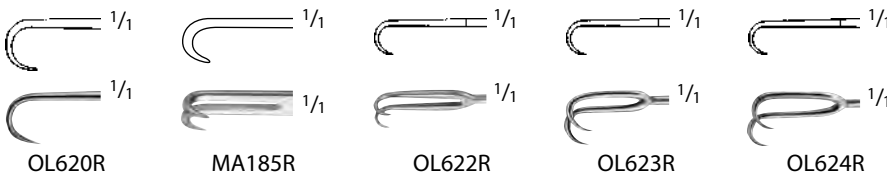

JOSEPH Skin Hook

Catalog Number	Tip	Prongs	Tip Size (mm)	Length (in.)
OL620R	SHARP	1	-	6 1/2
MA185R	SHARP	2	2	6 1/4
OL622R	SHARP	2	3	6 1/2
OL623R	SHARP	2	6	6 1/2
OL624R	SHARP	2	8	6 1/2
MD581	SHARP	2	10	6 1/2



MD581



MG370R



MG370R

COTTLE-JOSEPH Double Hook

Catalog Number	Tip Size (mm)	Length (in.)
MG370R	12	5 3/4



OL621R

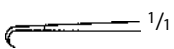

OL621R



FREER Double Hook

Catalog Number	Length (in.)
OL621R	6



OA357R-OA359R



OA357R

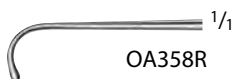

OA358R

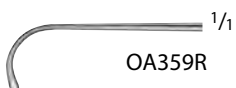

OA359R

GRAEFE Strabismus Nerve/Vessel Hook

Catalog Number	Tip	Length (in.)
OA357R	SMALL	5 1/2
OA358R	MEDIUM	5 1/2
OA359R	LARGE	5 1/2



BT901R-BT902R

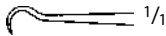

BT901R

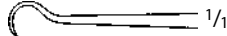

BT902R



BT911R-BT926R

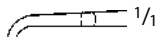

BT911R

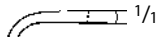

BT921R

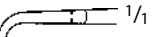

BT916R

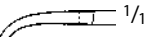

BT926R



BT904R-BT927R

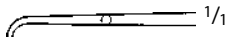

BT904R



BT912R



BT922R



BT917R



BT927R



BT906R

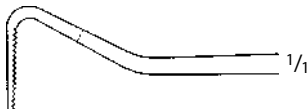

BT906R



BT913R-BT928R



BT913R



BT923R



BT918R



BT928R

MANNERFELT Retractor

Catalog Number	Prongs	Tip	Blade Shape	Blade Size (mm)	Length (in.)
BT901R	1	SHARP	HOOK CVD	-	5 1/4
BT902R	1	SHARP	HOOK CVD	-	6 1/8
BT911R	1	SHARP	SMALL CVD	SMALL PRONG	6 1/8
BT921R	1	SHARP	SMALL CVD	LARGE PRONG	6 1/8
BT916R	1	BLUNT	SMALL CVD	SMALL PRONG	6 1/8
BT926R	1	BLUNT	SMALL CVD	LAGRGE PRONG	6 1/8
BT904R	2	SHARP	SMALL CVD	3.5 x 12	6 1/8
BT912R	2	SHARP	SMALL CVD	5 x 4	6 1/8
BT922R	2	SHARP	SMALL CVD	8 x 8	6 1/8
BT917R	2	BLUNT	SMALL CVD	5.5 x 4	6 1/8
BT927R	2	BLUNT	SMALL CVD	7 x 8	6 1/8
BT906R	2	SHORT	ANG	8 x 12.5	6 1/8
BT913R	3	SHARP	SMALL CVD	5.5 x 7.2	6 1/8
BT923R	3	SHARP	SMALL CVD	7 x 11	6 1/8
BT918R	3	BLUNT	SMALL CVD	5.5 x 7.2	6 1/8
BT928R	3	BLUNT	SMALL CVD	7 x 11	6 1/8



BT943R-BT946R

LANGENBECK-MANNERFELT Retractor

Catalog Number	Blade Size (mm)	Length (in.)
BT943R	15 x 6	6 1/8
BT944R	20 x 6	6 1/8
BT945R	25 x 6	6 1/8
BT946R	30 x 8	6 1/8

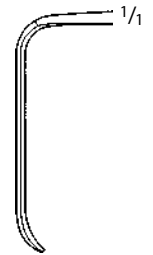
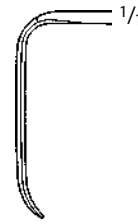
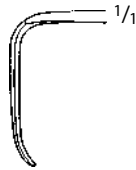
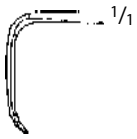

BT943R



BT944R



BT945R



BT946R



BT948R-BT958R

MANNERFELT Saddle Hook

Catalog Number	Tip Size (mm)	Length (in.)
BT940R	16 x 16	6 1/8
BT948R	12 x 12	6 1/8
BT949R	12 x 14	6 1/8
BT951R	14 x 16	6 1/8
BT958R	12 x 12 FEN	6 1/8

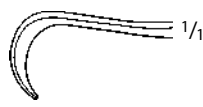
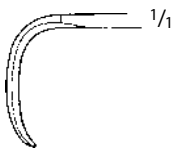

BT940R



BT948R



BT949R



BT951R

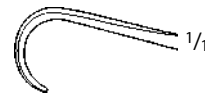

BT958R



BT964R

MANNERFELT Tendon Double Hook

Catalog Number	Length (in.)
BT964R	6 1/4



BT964R



BT966R



BT966R

MANNERFELT Double Spatula

Catalog Number	Length (in.)
BT966R	6 1/4



MB727R-MB733R



MB727R-MB733R

CRILE Retractor

Catalog Number	Size	Blade Size (mm)	Length (in.)
MB727R	1	3 x 11 / 6 x 21	4 1/4
MB728R	2	6 x 13 / 10 x 21	6 1/8
MB729R	3	16 x 25 / 17 x 35	6 1/4
MB730R	4	22 x 29 / 29 x 44	7
MB731R	5	29 x 41 / 35 x 51	7
MB732R	6	32 x 64 / 35 x 70	7 7/8
MB733R	7	41 x 76 / 51 x 79	8 7/8

TEBBETTS Breast Spatula,
 Semi-Malleable

Catalog Number	Length (in.)
MB384R	12 1/2



MB384R

TEBBETTS Breast Retractor

Catalog Number	Blade	Length (in.)
MB647R	DBL-ENDED	12



MB647R

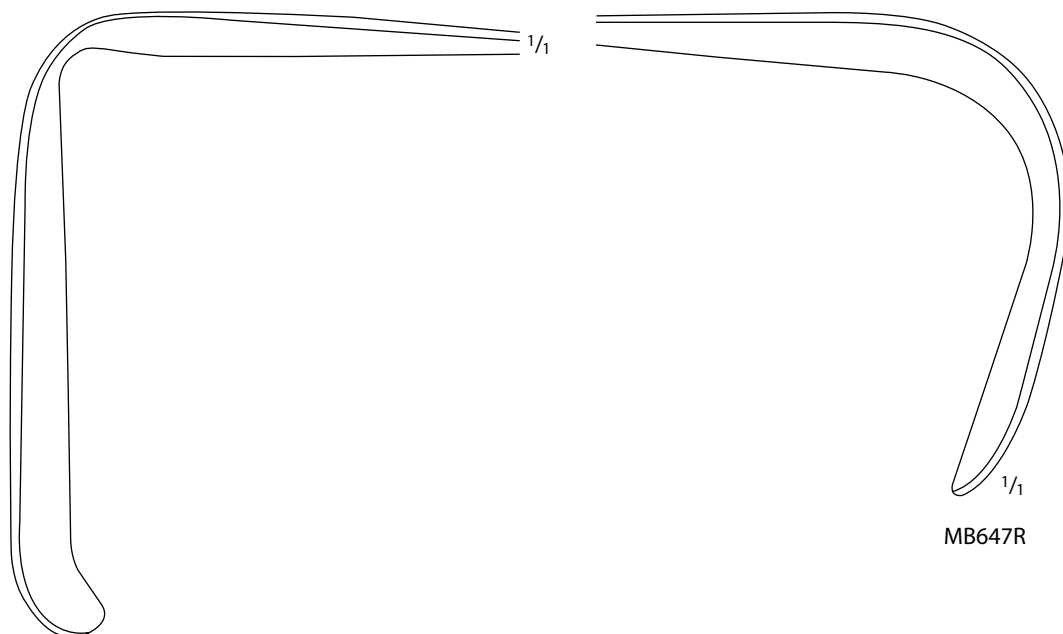

MB647R



MB934R

FREEMAN Facelift Retractor

Catalog Number	Length (in.)
MB934R	7



OL211R



OL211R



OL212R



OL212R



OA310R-OA314R



OA310R



OA311R



OA312R



OA313R



OA314R

COTTLE Alar (MASING) Retractor

Catalog Number	Blade Size (mm)	Length (in.)
OL211R	6 x 12	5 1/2
OL212R	10 x 12	5 1/2

DESMARRES Lid Retractor

Catalog Number	Blade Size (mm)	Length (in.)
OA310R	9 x 9	5 1/2
OA311R	9 x 12	5 1/2
OA312R	11 x 14	5 1/2
OA313R	12 x 16	5 1/2
OA314R	13 x 18	5 1/2



BV001R



BV001R

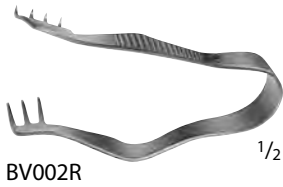

BV002R

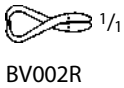

BV002R

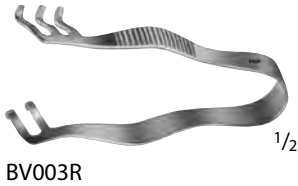

BV003R



BV003R



BV005R

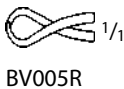

BV005R



BV008R, BV015R

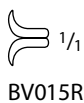

BV015R



BV008R

FINSEN Retractor

Catalog Number	Tip	Blade End	Length (in.)
BV001R	SHARP	2 x 3 PRONGS	2

FINSEN Retractor

Catalog Number	Tip	Blade End	Length (in.)
BV002R	SHARP	3 x 4 PRONGS	2 3/4

FINSEN Modified Retractor

Catalog Number	Tip	Blade End	Length (in.)
BV003R	BLUNT	2 x 3 PRONGS	3

FINSEN Retractor

Catalog Number	Tip	Blade End	Length (in.)
BV005R	SHARP	3 x 4 PRONGS	2 3/4

HEISS Self-Retaining Retractor

Catalog Number	Tip	Prongs	Length (in.)
BV015R	SHARP	4 x 4	4
BV008R	BLUNT	4 x 4	4



BV006R-BV007R



BV006R



BV007R

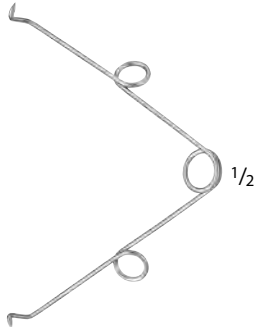

MD471

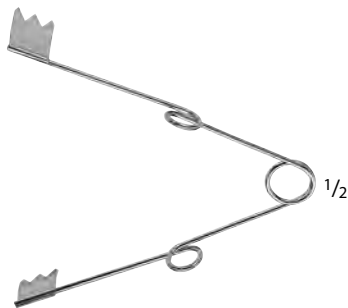

MB194R-MB195R

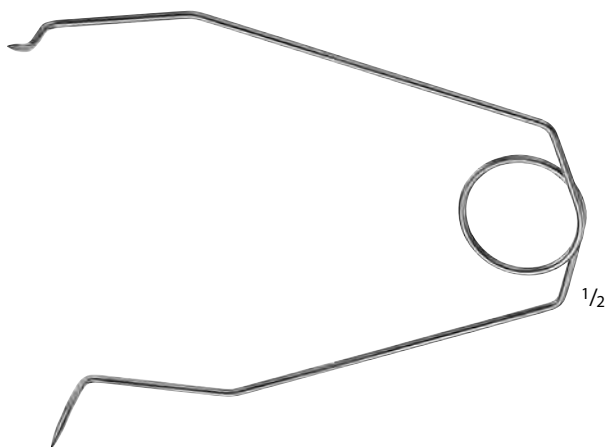

MB777R-MB196R

Spring Wire Retractor

Catalog Number	Tip	Prongs	Length (in.)
BV006R	BLUNT	3 x 3	1 3/4
BV007R	BLUNT	3 x 3	2 1/4
MD471	SHARP	1 x 1	3

Spring Wire Retractor

Catalog Number	Length (in.)
MB194R	3 1/2
MB195R	4 1/2

Spring Wire Retractor

Catalog Number	Size	Length (in.)
MB777R	SMALL	5
MB778R	MEDIUM	5 1/8
MB196R	LARGE	9



BV010R-BV011R

ALM Retractor

Catalog Number	Tip	Prongs	Length (in.)
BV010R	SHARP	4 x 4	2 3/4
BV011R	SHARP	4 x 4	4



BV010R

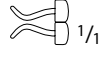

BV011R



BV028R

ALLPORT Retractor

Catalog Number	Tip	Prongs	Length (in.)
BV028R	SHARP	4 x 4	3 3/4

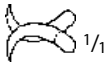

BV028R

Aluminum Hand, Blue Silicone Coated

Catalog Number	Size (in.)
FO917A	10 3/4 x 7 1/2
FO918A	16 1/8 x 11

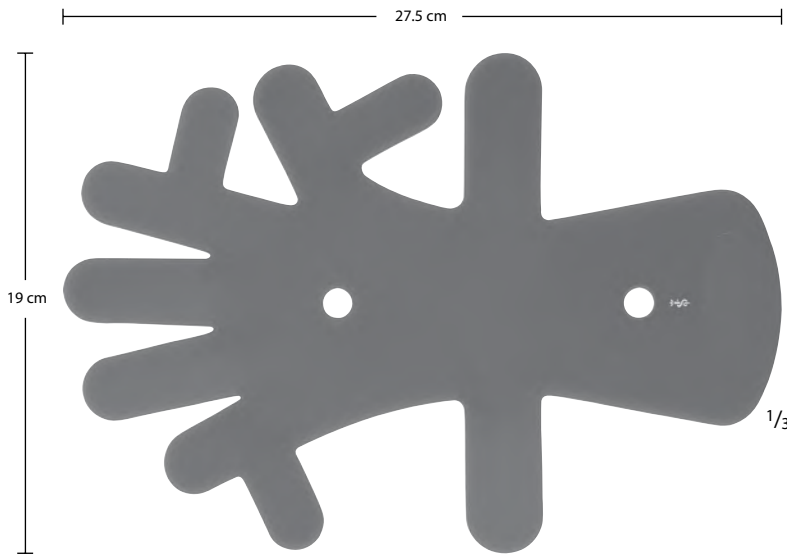

FO917A

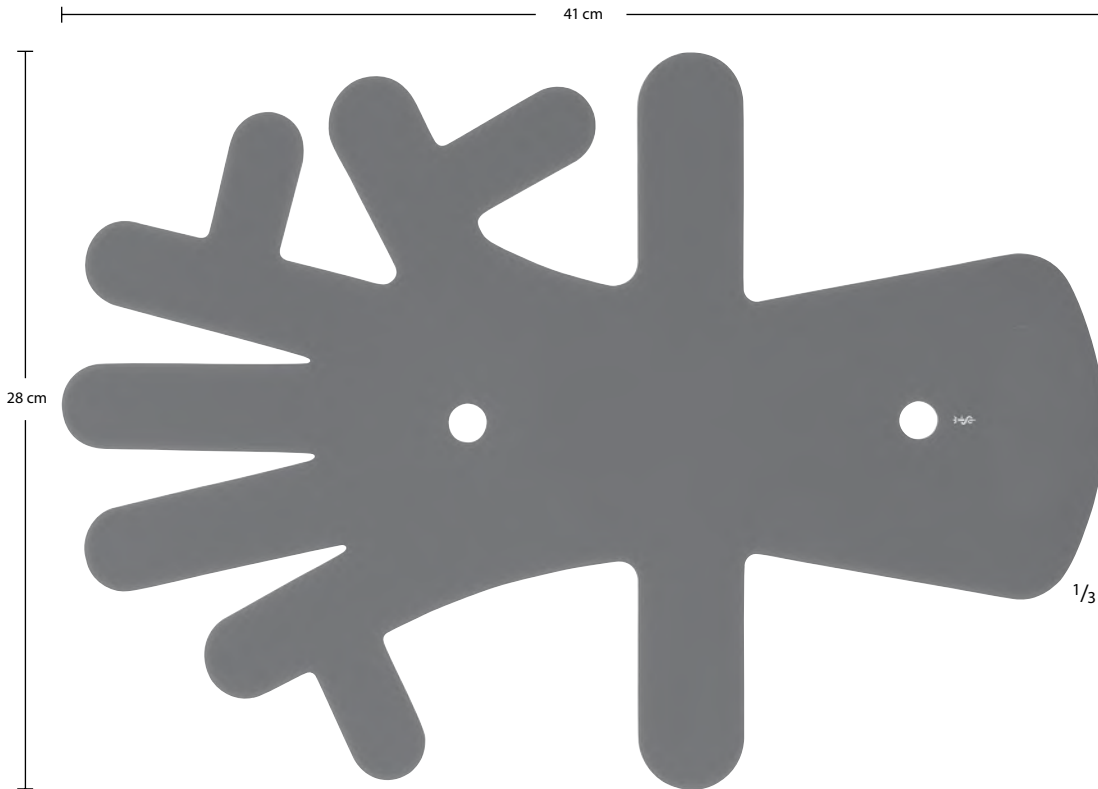

FO918A

Areola Cookie Cutter

Catalog Number	Diameter (mm)	Blade
AD123R	33.0	TOOTHED
AD125R	38.0	TOOTHED
AD127R	42.0	TOOTHED
AD129R	48.0	TOOTHED



SCHINK Knife, Adjustable From 0.1 To 2.0MM

Catalog Number	Length (in.)
BA706R	11 3/4
BA708R	

BA706R Includes:
 1 Spare Blade BA708R and
 1 Skin Straightening Plate BA709R





BA709R

Skin Straightening Plate

Catalog Number
BA709R



MD025

GOULIAN Skin Graft Knife Set

Catalog Number	Length (in.)
MD025	7 1/4
BA711R	BOX/50

MD025 includes 3 grafting templates: .20, .25, and .30 mm thick and blades



BA711R



MG575R

TEBBETTS Precision Knife Handle

Catalog Number	Blade Size (mm)	Length (in.)
MG575R	10 - 15	5 3/4



MG575R

Skin Graft Knife

Catalog Number	Item	Length (in.)
BA718R	SPARE BLADE, STERILE, 10/PKG	-
BA719R	KNIFE, W/ O BLADE	11 3/4

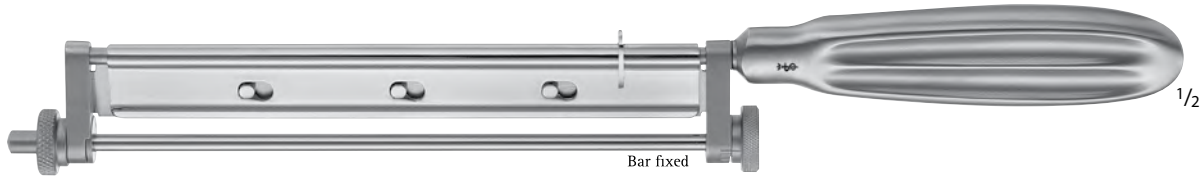

BA718R-BA719R

KEYES Dermal Punch Set

Catalog Number
OL670R

OL670R includes:
 5 interchangeable tips, handle and rack



OL670R

FOX Dermal Curettes

Catalog Number	Diameter (mm)	Length (in.)
MG150R	2	5 5/8
MG151R	3	5 5/8
MG152R	4	5 5/8
MG153R	5	5 5/8
MG154R	6	5 5/8



MG150R-MG154R



MG150R



MG151R



MG152R



MG153R



MG154R

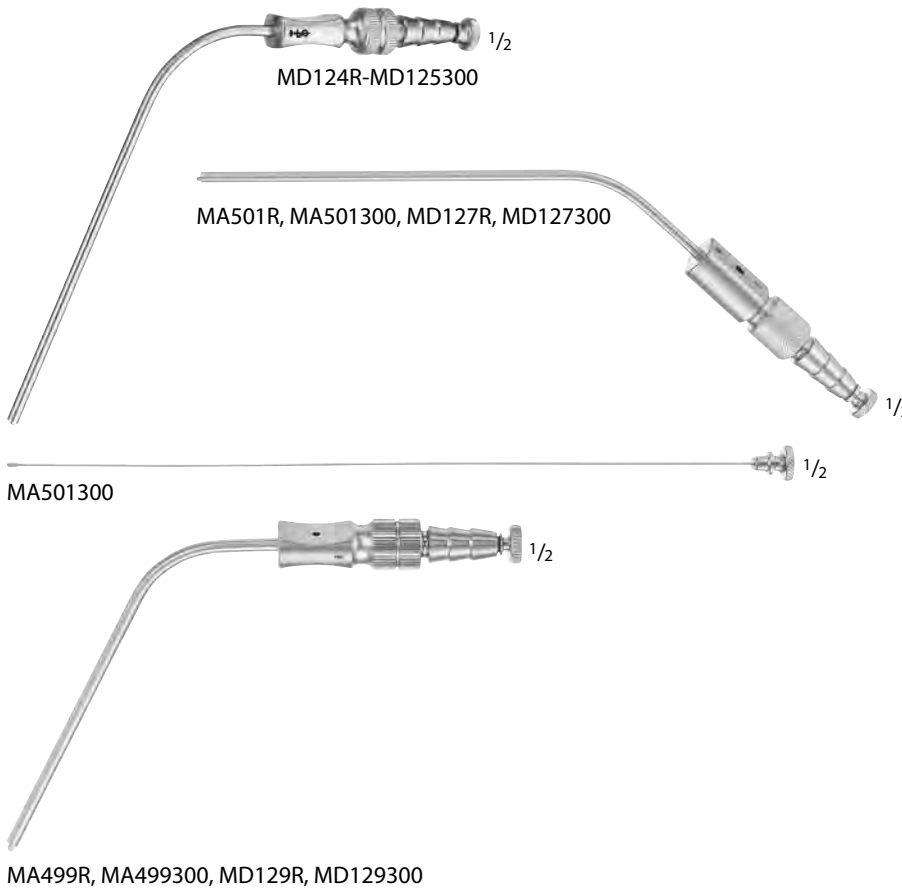

FRAZIER Suction Tube

Catalog Number	Tip Size (FR)	Description	Working Length (in.)
MD124R	7		4 1/4
MD124300	7	SUCTION STYLET W/ OLIVE TIP FOR MD124R	
MD125R	7		4 1/4
MD125300	8	SUCTION STYLET W/ OLIVE TIP FOR MD125R	
MA501R	9		4 1/4
MA501300		SUCTION STYLET W/ OLIVE TIP FOR MA501R	
MD127R	10		4 1/4
MD127300	10	SUCTION STYLET W/ OLIVE TIP FOR MD127R	
MA499R	11		4 1/4
MA499300	11	SUCTION STYLET W/ OLIVE TIP FOR MA499R	
MD129R	12		4 1/4
MD129300	12	SUCTION STYLET W/ OLIVE TIP FOR MD129R	

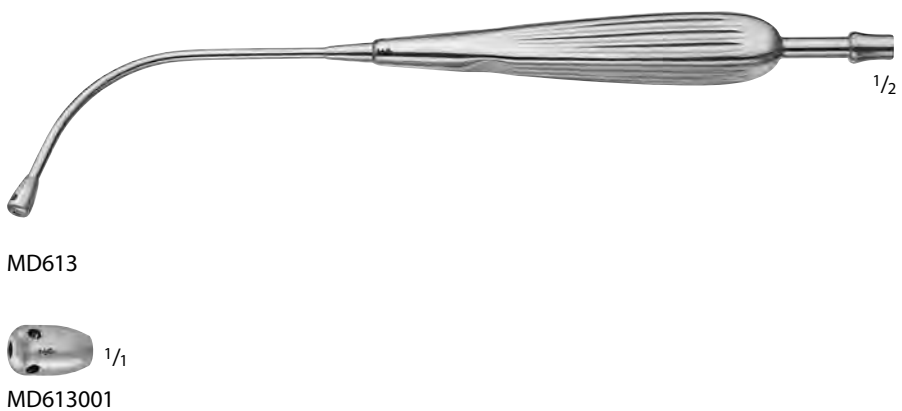

ANDREWS Pynchon Suction Tube

Catalog Number	Description	Length (in.)
MD613	-	9
MD613001	TIP ONLY F/ MD613	-

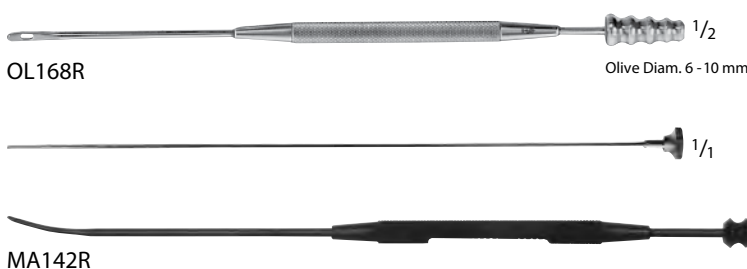

GORNEY Suction Dissector, Elevator

Catalog Number	Tip Size (mm)	Length (in.)
OL168R	6-10	7
MA142R	3	8 1/2

Let Us know if you could not find what you are looking for



DO711R

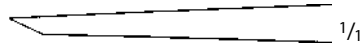

DO711R



FL120R-FL128R



FL120R-FL128R



FL173R-FL176R

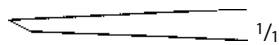

FL173R-FL176R



FL183R-FL187R

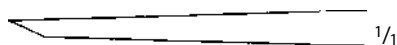

FL183R-FL187R

LUCAS Chisel, Angled

Catalog Number	Tip Size (mm)	Length (in.)
DO711R	4	6 1/4

Chisel, Angled

Catalog Number	Tip Size (mm)	Length (in.)
FL120R	4	5 1/2
FL122R	6	5 1/2
FL124R	8	5 1/2
FL126R	10	5 1/2
FL128R	12	5 1/2

PARTSCH Chisel

Catalog Number	Tip Size (mm)	Length (in.)
FL173R	3	5 1/2
FL174R	4	5 1/2
FL175R	5	5 1/2
FL176R	6	5 1/2
FL183R	3	6 3/4
FL184R	4	6 3/4
FL185R	5	6 3/4
FL186R	6	6 3/4
FL187R	7	6 3/4



DO715R

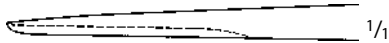

DO715R



FL130R-FL136R

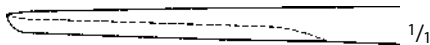

FL130R-FL136R



FL153R



FL153R



FL213R-FL216R

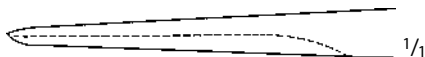

FL213R-FL216R



FL223R-FL227R

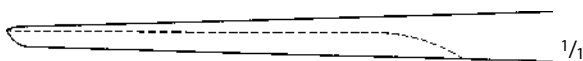

FL223R-FL227R



FL343R-FL347R

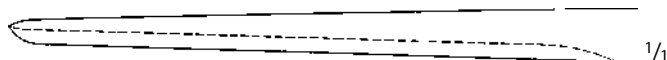

FL343R-FL347R

LUCAS Gouge

Catalog Number	Tip Size (mm)	Length (in.)
DO715R	3	6 1/4

Gouge

Catalog Number	Tip Size (mm)	Length (in.)
FL130R	4	5 1/2
FL132R	6	5 1/2
FL134R	8	5 1/2
FL136R	10	5 1/2

MANNERFELT Gouge

Catalog Number	Tip Size (mm)	Length (in.)
FL153R	3	6 1/8

PARTSCH Gouge

Catalog Number	Tip Size (mm)	Length (in.)
FL213R	3	5 1/2
FL214R	4	5 1/2
FL215R	5	5 1/2
FL216R	6	5 1/2
FL223R	3	6 3/4
FL224R	4	6 3/4
FL225R	5	6 3/4
FL226R	6	6 3/4
FL227R	7	6 3/4

ALEXANDER Gouge

Catalog Number	Tip Size (mm)	Length (in.)
FL343R	7	6 3/4
FL345R	9	6 3/4
FL347R	11	6 3/4



OL307R

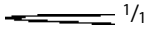

OL307R

COTTLE Fishtail Chisel, W/ Protected Ends

Catalog Number	Tip Size (mm)	Length (in.)
OL307R	8	7



FL110R-FL118R

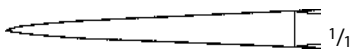

FL110R-FL118R

STRAND Osteotome

Catalog Number	Tip Size (mm)	Blade	Length (in.)
FL110R	4	STR	5 1/2
FL112R	6	STR	5 1/2
FL114R	8	STR	5 1/2
FL116R	10	STR	5 1/2
FL118R	12	STR	5 1/2



FL144R-FL148R

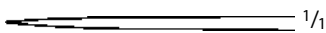

FL144R-FL148R

MANNERFELT Osteotome

Catalog Number	Tip Size (mm)	Length (in.)
FL144R	4	6 1/8
FL146R	6	6 1/8
FL148R	8	6 1/8



DF112R

Mallet, Lead Filled, 80gr

Catalog Number	Diameter (mm)	Length (in.)
DF112R	22	6 1/2



FO900R-FO901R



FO901R

Finger Ring Saw

Catalog Number	Item	Length (in.)
FO900R	COMPLETE	6
FO901R	REPLACEMENT BLADE	-



FO903R



FO903R

Nail Extracting Forceps

Catalog Number	Length (in.)
FO903R	5 1/4



DO810R



DO810R

OBWEGESER Awl F/ Lower Jaw

Catalog Number	Length (in.)
DO810R	5 1/2



DO812R



DO812R

OBWEGESER Suture Wire Awl

Catalog Number	Length (in.)
DO812R	7 3/4
DO811R	9



DO811R



DO811R



FK318R

1/2

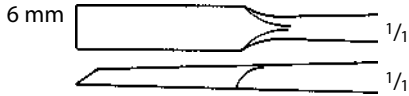

FK318R



FK317R

1/2

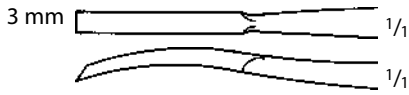

FK317R



FK319R

1/2



FK319R



FK321R

1/2

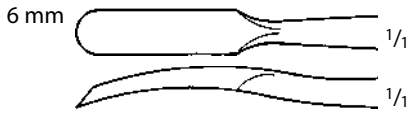

FK321R



DO543R

1/2

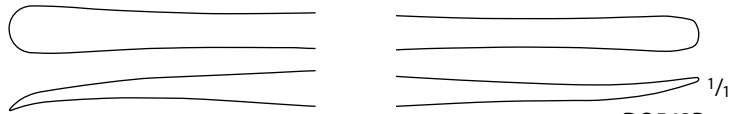

DO543R



DO552R-DO553R

1/2

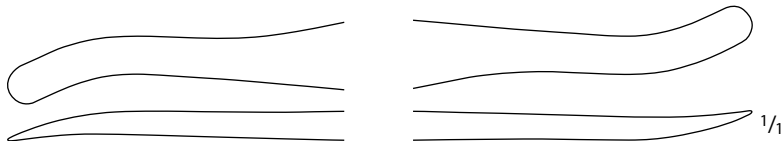

DO552R

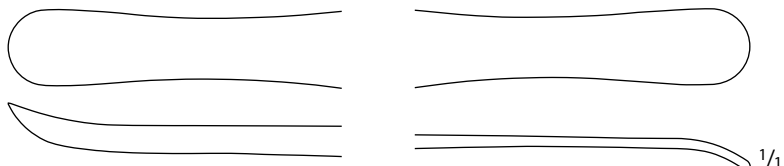

DO553R

Raspatory W/ PEEK Handle

Catalog Number	Tip	Tip Size (mm)	Blade	Length (in.)
FK318R	FLAT	6	STR	7 1/2
FK317R	FLAT	3	CVD	7 1/4
FK319R	FLAT	6	CVD	7 1/2
FK321R	RND	6	CVD	7 1/2

MOLT Raspatory and Elevator, Double Ended

Catalog Number	Length (in.)
DO543R	7

SELDIN Raspatory, Double Ended

Catalog Number	Size	Length (in.)
DO552R	SMALL	7 3/4
DO553R	LARGE	7 3/4



DO773R

MILLER Bone Rasp

Catalog Number	Tip Size (mm)	Length (in.)
DO773R	6.0 / 5.0	7

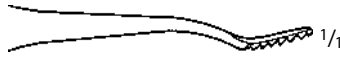

DO773R

5 mm



FK530R-FK552R

MANNERFELT Modified Elevator

Catalog Number	Tip	Tip Size (mm)	Length (in.)
FK530R	SPOON	4	6 1/8
FK532R	SPOON	7	6 1/8
FK534R	SPOON	9	6 1/8
FK541R	CVD	3	6 1/8
FK543R	CVD	6	6 1/8
FK552R	SLIGHT-CVD, ROUND	8	6 1/8

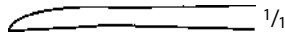
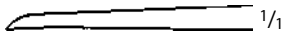

FK530R

FK532R

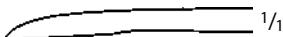

FK534R

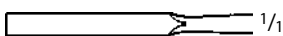
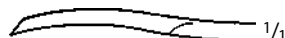
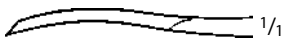

FK541R

FK543R

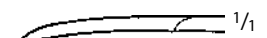

FK552R

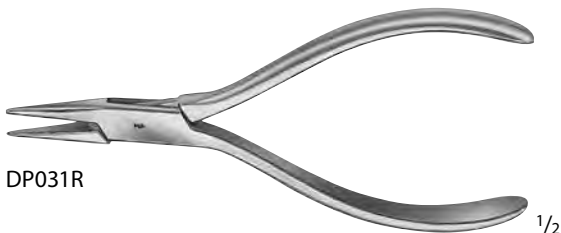

DP031R

MARBURG Needle Nose Pliers

Catalog Number	Tip	Length (in.)
DP031R	SERR	5 1/2



DP031R



Universal Wire Cutter

Catalog Number	For Wire Size	Length (in.)
DP501R	SOFT, UP TO 1.5MM AND HARD, UP TO 1.0MM	6
DP505R	SOFT, UP TO 1.5MM AND HARD, UP TO 1.2MM	6 1/4

Wire Cutter, W/ Specially Hardened Cutting Edges

Catalog Number	For Wire Size	Blade End	Length (in.)
DP520R	SOFT, UP TO 1.5MM AND	X-HARD EDGE	5 3/4
DP530R	SOFT, UP TO 1.5MM AND	X-HARD EDGE	5 1/2



DP552R

1/2

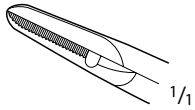

DP552R

1/1

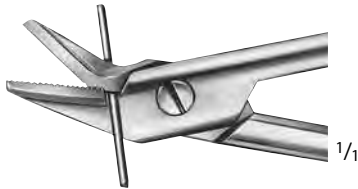

1/1

DUROTIP™ TC Wire Cutting Scissors

Catalog Number	For Wire Size	Blade	Length (in.)
DP552R	SOFT, UP TO 1.2MM AND HARD, UP TO 0.8 MM	1-SERR	4 3/4



DP560R-DP569R

1/2

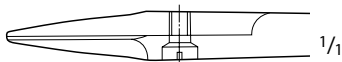

DP560R

1/1

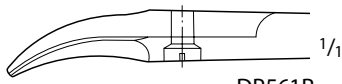

DP561R

1/1

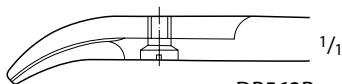

DP563R

1/1

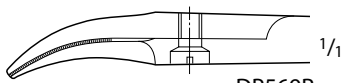

DP569R

1/1

BEEBE Crown Scissors

Catalog Number	Tip	Blade	Length (in.)
DP560R	SHARP	STR	4 1/4
DP561R	SHARP	CVD	4 1/4
DP563R	BROAD	CVD	4 1/4
DP569R	ONE-SERR	CVD	4 1/4

- The arterial clips have a slightly inwards curved jaw tip to prevent slipping, see Fig.1
- The venous clips have a flat parallel closing jaw, see Fig. 2

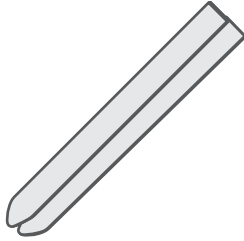

Fig. 1

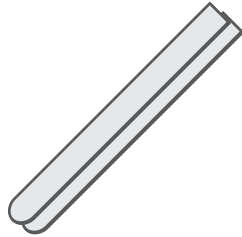

Fig. 2



FD870R-FD874R



FD875R-FD878R



FD879R-FD880R



FD881R-FD884R



FD885R-FD888R

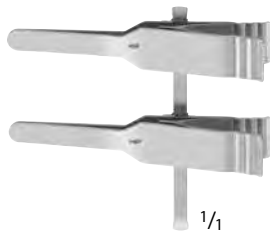

FD889R-FD890R



FD891R-FD894R



FD895R



FD896R-FD897R



FD896R



FD897R

ACLAND Micro Vessel Clips

Catalog Number	Jaw Length (mm)	Size	Description	Vessel Size (mm)
FD870R	8	B-1	Artery	0.3-1.0
FD871R	8	B-1	Vein	0.3-1.0
FD872R	11	B-2	Artery	0.6-1.4
FD873R	11	B-2	Vein	0.6-1.4
FD874R	16	B-3	Artery	1.0-2.2
FD875R	16	B-3	Vein	1.0-2.2
FD876R	24	HD-S	Artery	1.5-3.3
FD877R	24	HD-S	Vein	1.5-3.3
FD878R	35	RD-S	Artery	2.0-5.0
FD879R	35	RD-S	Vein	2.0-5.0
FD880R	8	B-1	Artery	0.3-1.0
FD881R	8	B-1	Vein	0.3-1.0
FD882R	11	B-2	Artery	0.6-1.4
FD883R	11	B-2	Vein	0.6-1.4
FD884R	16	B-3	Artery	1.0-2.2
FD885R	16	B-3	Vein	1.0-2.2
FD886R	24	HD-D	Artery	1.5-3.3
FD887R	24	HD-D	Vein	1.5-3.3
FD888R	35	RD-D	Artery	2.0-5.0
FD889R	35	RD-D	Vein	2.0-5.0
FD890R	8	B-1	Artery	0.3-1.0
FD891R	8	B-1	Vein	0.3-1.0
FD892R	11	B-2	Artery	0.6-1.4
FD893R	11	B-2	Vein	0.6-1.4
FD894R	16	B-3	Artery	1.0-2.2
FD895R	16	B-3	Vein	1.0-2.2
FD896R	5 1/2	B-1, B-2	Clip Applying Forceps	-
FD897R	5 1/2	B-3, HD, RD	Clip Applying Forceps	-

All items are sold individually



FD560R-FD562R

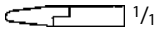

FD560R

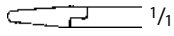

FD561R

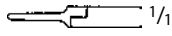

FD562R



FD568R



FD569R



FD571R

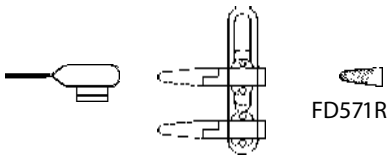

FD571R



FD572R



FD572R

BIEMER Vessel Clip

Catalog Number	Jaw Length (mm)	Jaw Opening (mm)	Closing Force
FD560R	6	4	30 - 40
FD561R	9	5	30 - 40
FD562R	9	5	20 - 25

BIEMER Applying Forceps,
 F/ FD560R-FD562R, FD611R-FD615R

Catalog Number	Description	Length (in.)
FD568R	W/ O LOCK	5 1/2
FD569R	W/ LOCK	5 1/2

BIEMER Micro Approximator Only

Catalog Number	Jaw Length (mm)	Jaw Opening (mm)	Closing Force (gr)
FD571R	6	2	30 - 40

BIEMER Applying Forceps, F/ FD571R

Catalog Number	Length (in.)
FD572R	5 3/4



FD575R



FD576R



Micro Approximator

Catalog Number	Description
FD575R	COMPLETE WITH KEY
FD576R	KEY ALONE

BIEMER-MÜLLER Approximator

Catalog Number	Blade	Jaw Length (mm)	Jaw Opening (mm)	Closing Force (gr)
FD613R	STR, DEL	9	4	25 - 30
FD615R	STR	4,5	3	25 - 30
FD611R	STR	9	3	25 - 30
FD614R	ANG, DEL	9	3	25 - 30
FD612R	ANG	9	3	25 - 30



FD613R



FD615R



FD611R



FD614R



FD612R

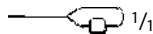
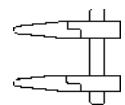
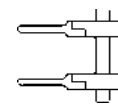
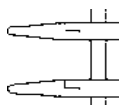
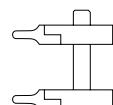
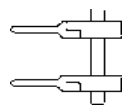

FD576R



FD635R

BIEMER Approximator, F/ Nerves

Catalog Number	Description
FD576R	KEY ALONE
FD635R	APPROXIMATOR COMPLETE WITH KEY AND NEEDLES
FD636R	SPARE NEEDLES, PR



Eye

Scissors	812 - 828
Micro Needle Holders	829 - 831
Forceps	832 - 844
Specula	845 - 847
Hooks and Retractors	847 - 849
Hooks / Retractors / Manipulators	850 - 861
Fixation Rings and Markers	862 - 864
Probes and Dilators	865 - 866
Lacrimal Intubation Sets	867 - 868
Cannulas	869 - 875
Miscellaneous	876 - 877



BC190R, MA471R-MA474R, MB605R



MB605R



BC190R

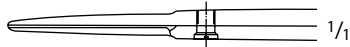

MA473R

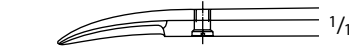

MA472R



MA471R

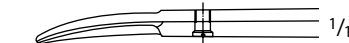

MA474R

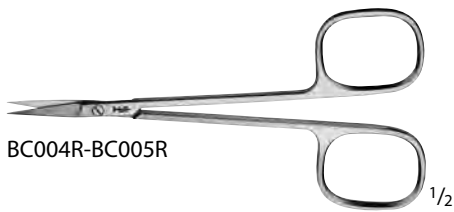

BC004R-BC005R

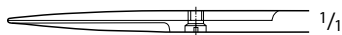

BC004R



BC005R

Iris Scissors

Catalog Number	Tip	Blade	Handle	Length (in.)
MB605R	S/S	STR	RIBBON	4
MA471R	S/S	STR	RIBBON	4 1/4
MA473R	B/B	STR	RIBBON	4 1/4
BC190R	S/S	CVD	RIBBON	4
MA472R	S/S	CVD	RIBBON	4 1/4
MA474R	B/B	CVD	RIBBON	4 1/4
BC004R	S/S	STR	SQUARE	4 1/2
BC005R	S/S	CVD	SQUARE	4 1/2

Iris Scissors (continued)

Catalog Number	Tip	Blade	Handle	Length (in.)
BC100R	S/S	STR	ROUND	3 1/2
BC056R	S/S	STR	ROUND	3 3/4
BC060R	S/S	STR	ROUND	4 1/8
BC110R	S/S	STR	ROUND	4 1/4
BC112R	S/B	STR	ROUND	4 1/4
BC106R	S/S	STR	ROUND	4 1/2
BC064R	S/S	STR	ROUND	4 3/4
BC101R	S/S	CVD	ROUND	3 1/2
BC057R	S/S	CVD	ROUND	3 3/4
BC061R	S/S	CVD	ROUND	4 1/8
BC111R	S/S	CVD	ROUND	4 1/4
BC113R	S/B	CVD	ROUND	4 1/4
BC107R	S/S	CVD	ROUND	4 1/2
BC065R	S/S	CVD	ROUND	4 3/4
BC117R	S/S	LAT-ANG	ROUND	4 1/4
BC050R	S/S	STR	ROUND, CENTERED	4 1/4

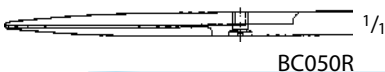
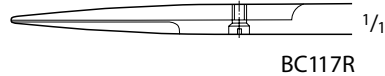
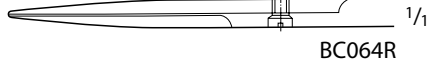
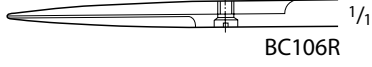
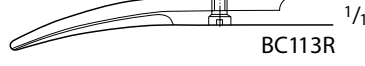
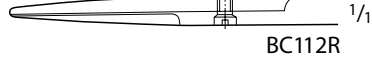
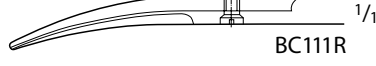
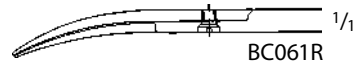
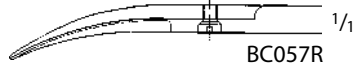
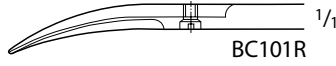
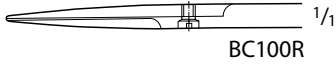

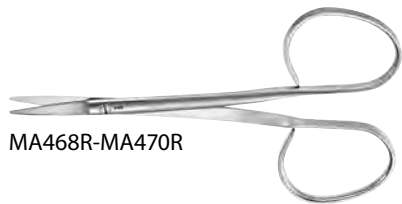

MA468R-MA470R

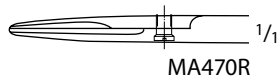

MA470R

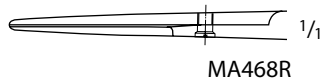

MA468R

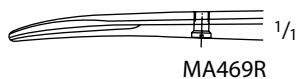

MA469R



BC186R-BC187R

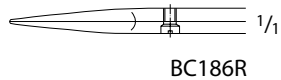

BC186R

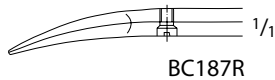

BC187R



OK366R



OK366R

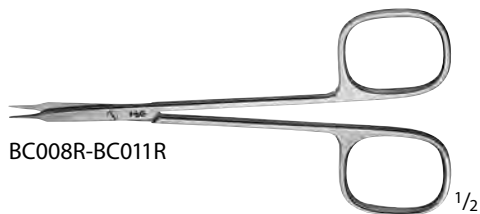

BC008R-BC011R

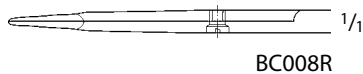

BC008R

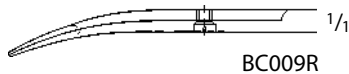

BC009R

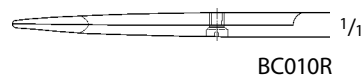

BC010R

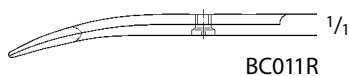

BC011R

STEVENS Tenotomy Scissors

Catalog Number	Tip	Blade	Handle	Length (in.)
BC186R	S/S	STR	RIBBON	4
MA470R	B/B	STR	RIBBON	3 3/4
MA468R	B/B	STR	RIBBON	3 7/8
MA469R	B/B	CVD	RIBBON	3 3/4
BC187R	S/S	CVD	RIBBON	4
OK366R	B/B	CVD	RIBBON	4 1/4
BC008R	S/S	STR	SQUARE	4 1/2
BC010R	B/B	STR	SQUARE	4 1/2
BC009R	S/S	CVD	SQUARE	4 1/2
BC011R	B/B	CVD	SQUARE	4 1/2

STEVENS Tenotomy Scissors
 (continued)

Catalog Number	Tip	Blade	Handle	Length (in.)
BC170R	S/S	STR	ROUND	4 1/4
BC172R	B/B	STR	ROUND	4 1/4
BC194R	B/B	STR	ROUND	5
MA467R	B/B	STR	ROUND	5 3/4
BC171R	S/S	CVD	ROUND	4 1/4
BC173R	B/B	CVD	ROUND	4 1/4
BC195R	B/B	CVD	ROUND	5
MA466R	B/B	CVD	ROUND	5 3/4

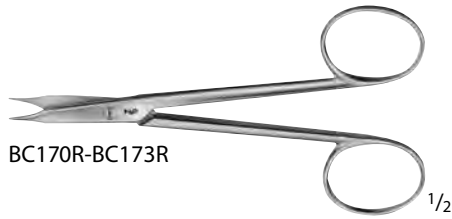

BC170R-BC173R

1/2

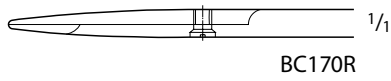

BC170R

1/1

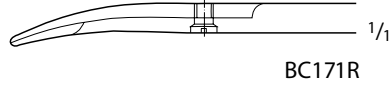

BC171R

1/1

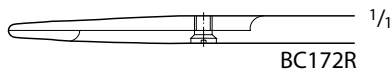

BC172R

1/1

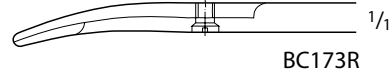

BC173R

1/1



BC194R-BC195R

1/2

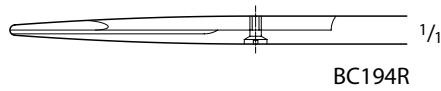

BC194R

1/1

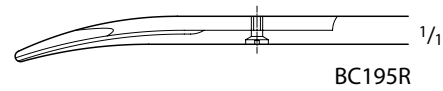

BC195R

1/1



MA466R-MA467R

1/2

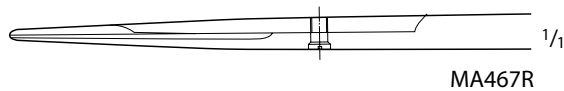

MA467R

1/1

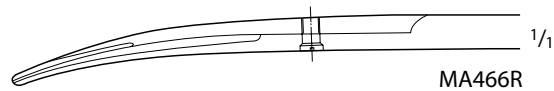

MA466R

1/1



BC175R

1/2

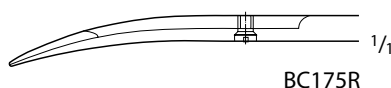

BC175R

1/1

JAMESON-WERBER Tenotomy Scissors

Catalog Number	Tip	Blade	Length (in.)
BC175R	B/B	DEL, CVD	5 1/8

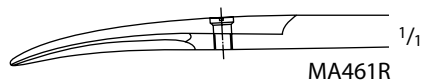
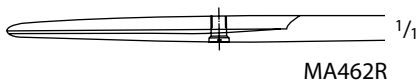
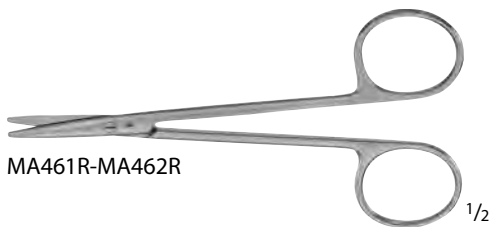
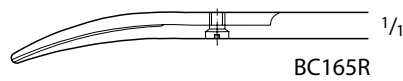
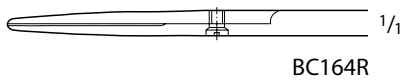
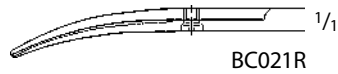
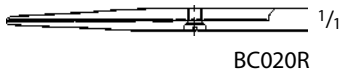
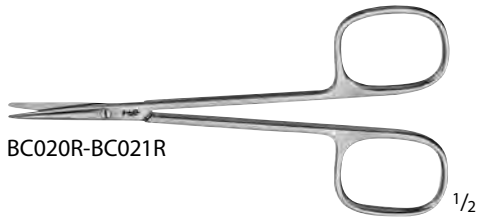
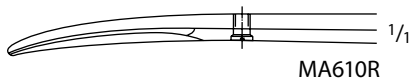
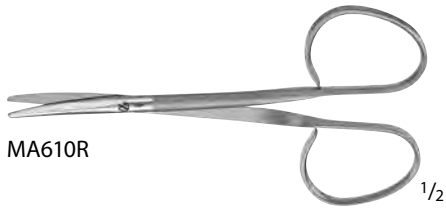

Strabismus Scissors, Delicate

Catalog Number	Tip	Blade	Handle	Length (in.)
MA610R	B/B	CVD	RIBBON	4 1/4
BC020R	B/B	STR	SQUARE	4 1/2
BC021R	B/B	CVD	SQUARE	4 1/2
BC164R	B/B	STR	ROUND	4 1/2
BC165R	B/B	CVD	ROUND	4 1/2

KNAPP Strabismus Scissors, Delicate

Catalog Number	Tip	Blade	Length (in.)
MA462R	B/B	STR	4 3/4
MA461R	B/B	CVD	4 3/4



MA874R, OC430R, US141R



MA874R

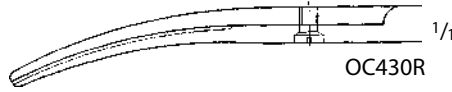

OC430R



US141

Enucleation Scissors

Catalog Number	Tip	Blade	Length (in.)
OC430R	B/B	SLIGHT CVD	5
US141	B/B	MEDIUM CVD	5 1/4
MA874R	B/B	FULL CVD	5 1/8



MA475R

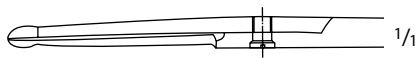

MA475R

Eye Scissors

Catalog Number	Tip	Blade	Length (in.)
MA475R	PROBE	ANG	4 1/2

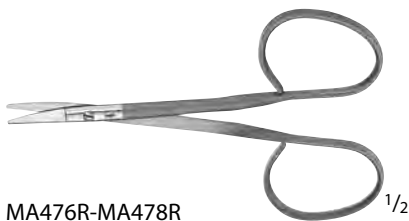

MA476R-MA478R

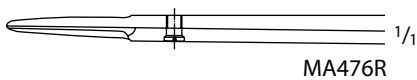

MA476R

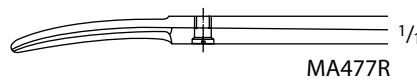

MA477R

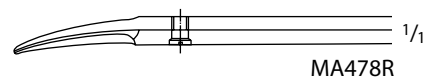

MA478R

Utility Scissors, Ribbon Handle

Catalog Number	Tip	Blade	Length (in.)
MA476R	B/B	STR	4
MA477R	B/B	CVD	4
MA478R	B/B	CVD	4

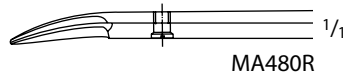
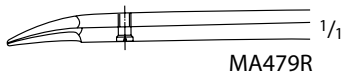
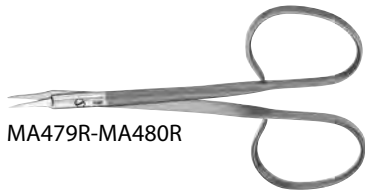

Stitch Scissors, Ribbon Handle

Catalog Number	Tip	Blade	Length (in.)
MA479R	S/S	CVD	3 3/4
MA480R	S/S	CVD	4 3/4



Stitch Scissors

Catalog Number	Tip	Blade	Length (in.)
MA976R	S/S	STR	4



WILMER Conjunctival Scissors

Catalog Number	Tip	Blade	Length (in.)
MA871R	S/S	ANG-FLAT	4 1/8



IOL Cutter

Catalog Number	Blade	Blade Length (mm)	Diameter (mm)	Length (in.)
MA774R	SERR	6	2	4 1/2

DUROTIP Tungsten Carbide (TC) Scissors

- Excellent cutting accuracy
- Long working life
- Gold-plated rings

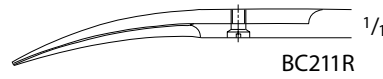
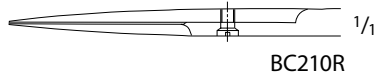

DUROTIP TC Iris Scissors, Delicate

Catalog Number	Tip	Blade	Length (in.)
BC210R	S/S	STR	4 1/4
BC211R	S/S	CVD	4 1/4

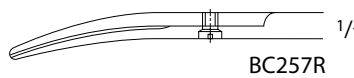
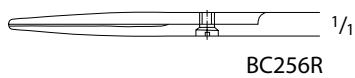
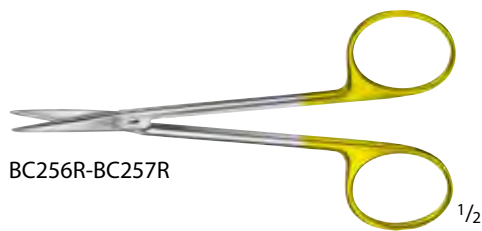

DUROTIP TC Strabismus Scissors, Delicate

Catalog Number	Tip	Blade	Length (in.)
BC256R	B/B	STR	4 1/2
BC257R	B/B	CVD	4 1/2



Wavecut

■ Wavecut scissors have one serrated cutting edge to help prevent tissue from slipping. The W after the item number indicates the scissors are the wavecut style, e.g. BC211W.



BC211W

1/2

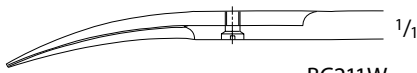

BC211W

1/1

DUROTIP TC Iris Scissors, Wavecut

Catalog Number	Tip	Blade	Length (in.)
BC211W	S/S	CVD	4 1/4



BC257W

1/2

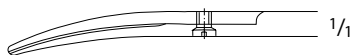

BC257W

1/1

DUROTIP TC Strabismus Wavecut Scissors

Catalog Number	Tip	Blade	Length (in.)
BC257W	B/B	CVD	4 1/2



OC498R-OC500R

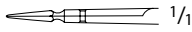

OC498R

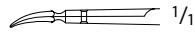

OC499R



OC500R

VANNAS Micro Scissors

Catalog Number	Tip	Blade	Handle	Length (in.)
OC498R	S/S	STR	FLAT, SERR	3 1/4
OC499R	S/S	CVD	FLAT, SERR	3 1/4
OC500R	S/S	ANG	FLAT, SERR	3 1/4



FD011R-FD015R



FD014R



FD015R

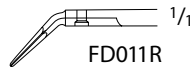

FD011R

VANNAS Micro Scissors

Catalog Number	Tip	Blade	Handle	Length (in.)
FD014R	S/S	STR	FLAT, SERR	4 3/4
FD015R	S/S	CVD	FLAT, SERR	4 3/4
FD011R	S/S	ANG	FLAT, SERR	4 3/4
FD018R	S/S	STR	FLAT, SERR	6 1/4
FD019R	S/S	CVD	FLAT, SERR	6 1/4



FD018R-FD019R

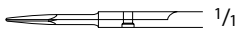

FD018R

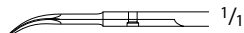

FD019R



MA865R

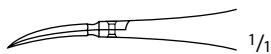

MA865R

VANNAS Micro Scissors, Wide Handle

Catalog Number	Tip	Tip Size (mm)	Blade	Handle	Length (in.)
MA865R	S/S	10	CVD	FLAT, WIDE SERR	4 3/4

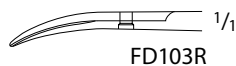
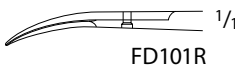
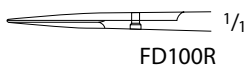
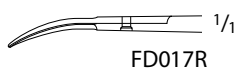
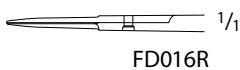
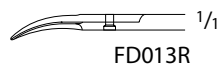
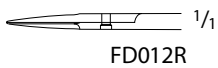
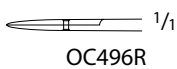

VANNAS Capsulotomy Scissors

Catalog Number	Tip	Blade	Handle	Length (in.)
MA483R	S/S	STR	FLAT, SERR	3 1/4
MA484R	S/S	CVD	FLAT, SERR	3 1/4
MA485R	S/S	ANG-DOWN	FLAT, SERR	3 1/4
MA486R	S/S	ANG-UP	FLAT, SERR	3 1/4

Micro Scissors

Catalog Number	Tip	Blade	Handle	Length (in.)
OC496R	S/S	STR	FLAT, SERR	4 1/8
OC497R	S/S	CVD	FLAT, SERR	4 1/8
FD012R	S/S	STR	FLAT, SERR	4 3/4
FD013R	S/S	CVD	FLAT, SERR	4 3/4
FD016R	S/S	STR	FLAT, SERR	6 1/4
FD017R	S/S	CVD	FLAT, SERR	6 1/4
FD100R	S/S	STR	ROUND	5 3/4
FD101R	S/S	CVD	ROUND	5 3/4
FD103R	B/B	CVD	ROUND	5 3/4

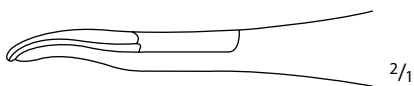
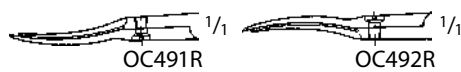
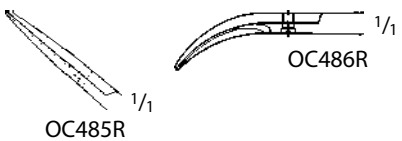
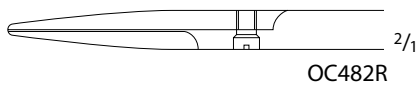
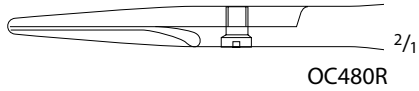

MCCLURE Micro Scissors

Catalog Number	Tip	Blade	Handle	Length (in.)
OC480R	S/S	STR	FLAT, SERR	3 3/4

NOYES Micro Scissors

Catalog Number	Tip	Blade	Handle	Length (in.)
OC482R	S/B	STR	FLAT, SERR	5

CASTROVIEJO Corneal Scissors

Catalog Number	Tip	Blade	Handle	Length (in.)
OC485R	B/B	LAT-ANG	FLAT, SERR	3 3/4
OC486R	B/B	LAT-CVD	FLAT, SERR	3 3/4
OC491R	B/B	LEFT-CVD	FLAT, SERR	4 3/8
OC492R	B/B	RIGHT-CVD	FLAT, SERR	4 3/8

CASTROVIEJO Corneal Section Scissors

Catalog Number	Tip	Tip Size (mm)	Blade	Handle	Length (in.)
MA850R	B/B	9	CVD, ANG RIGHT	FLAT, SERR	4 1/4
MA851R	B/B	9	CVD, ANG LEFT	FLAT, SERR	4 1/4



MA858R



MA858R



MA848R

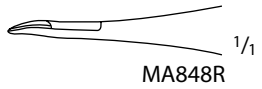

MA848R



MA849R

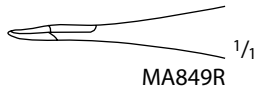

MA849R



MA852R



MA852R



MA853R



MA853R



MA854R



MA854R



MA855R



MA855R

CASTROVIEJO Universal Corneal Scissors

Catalog Number	Tip	Tip Size	Blade	Handle	Length (in.)
MA858R	B/B	16 MM FROM MID-SCREW	CVD	FLAT, FENESTRATED	4 3/4

CASTROVIEJO Corneal Scissors

Catalog Number	Tip	Tip Size	Blade	Handle	Length (in.)
MA848R	B/B	SMALL	CVD RIGHT	FLAT, WIDE SERR	4
MA849R	B/B	SMALL	CVD LEFT	FLAT, WIDE SERR	4

TROUTMAN-CASTROVIEJO Corneal Scissors, W/ Catch

Catalog Number	Tip	Tip Size	Blade	Handle	Length (in.)
MA852R	B/B	MEDIUM	CVD RIGHT	FLAT, WIDE SERR	4 1/8
MA853R	B/B	MEDIUM	CVD LEFT	FLAT, WIDE SERR	4 1/8

TROUTMAN-KATZIN Corneal Scissors, W/ Catch

Catalog Number	Tip	Blade	Handle	Length (in.)
MA854R	B/B	STRONG CVD RIGHT	FLAT, WIDE SERR	4 1/8
MA855R	B/B	STRONG CVD LEFT	FLAT, WIDE SERR	4 1/8



MA847R



MA847R



MA859R

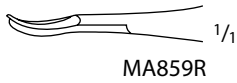

MA859R



MA860R



MA860R



MA856R

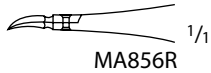

MA856R



MA857R

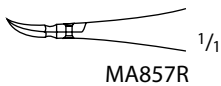

MA857R



MA873R

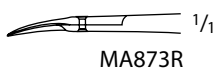

MA873R

TROUTMAN Corneal Scissors, W/ Catch

Catalog Number	Tip	Blade	Handle	Length (in.)
MA847R	B/B	CVD RIGHT	FLAT, WIDE SERR	4 1/8

KATZIN Corneal Transplant Scissors

Catalog Number	Tip	Tip Size	Blade	Handle	Length (in.)
MA859R	B/B	MEDIUM	CVD RIGHT	FLAT, FENESTRATED	4 1/8
MA860R	B/B	MEDIUM	CVD LEFT	FLAT, FENESTRATED	4 1/8

RICH Corneal Scissors

Catalog Number	Tip	Tip Size	Blade	Handle	Length (in.)
MA856R	S/S	X-DEL	CVD RIGHT	FLAT, WIDE SERR	4 1/8
MA857R	S/S	X-DEL	CVD LEFT	FLAT, WIDE SERR	4 1/8

Micro Iris Scissors

Catalog Number	Tip	Tip Size	Blade	Handle	Length (in.)
MA873R	S/S	10 MM FROM MID-SCREW	CVD	FLAT, SERR	4 1/8



MA861R

1/1



1/1

MA861R



MA862R

1/2



1/1

MA862R



MA864R

1/2



1/1

MA864R



MA866R

1/2

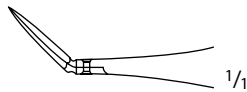

1/1

MA866R



MA867R

1/2

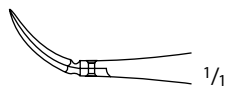

1/1

MA867R

BARRAQUER Iris Scissors

Catalog Number	Tip	Tip Size (mm)	Blade	Length (in.)
MA861R	B/B	8	ANG	2 1/4

JAFFE Stitch Scissors

Catalog Number	Tip	Blade	Handle	Length (in.)
MA862R	X-SHARP/ X-SHARP	CVD	FLAT, WIDE SERR	4 3/4

Stitch Scissors, Fine

Catalog Number	Tip	Blade	Handle	Length (in.)
MA864R	S/S	STR	FLAT, WIDE SERR	5 1/8

STERN-GILLS Scissors

Catalog Number	Tip	Tip Size (mm)	Blade	Handle	Length (in.)
MA866R	S/S	10	STR-ANG FORWARD	FLAT, WIDE SERR	4 1/2

URIBE-STERN Scissors

Catalog Number	Tip	Tip Size (mm)	Blade	Handle	Length (in.)
MA867R	S/S	10	CVD-ANG FORWARD	FLAT, WIDE SERR	4 3/4



MA868R

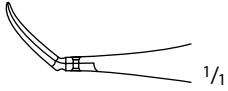

MA868R



MA870R

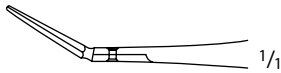

MA870R



MA612R

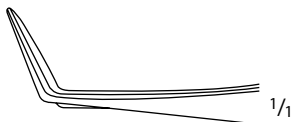

MA612R

UTHOFF-GILLS Capsulotomy Scissors

Catalog Number	Tip	Tip Size (mm)	Blade	Handle	Length (in.)
MA868R	B/B	10	ANG, CVD	FLAT, WIDE SERR	4 3/4

GILLS-WELSH VANNAS Scissors

Catalog Number	Tip	Tip Size (mm)	Handle	Length (in.)
MA870R	S/S	11	FLAT, WIDE SERR	3 1/4

DEWECKER Iris Scissors

Catalog Number	Tip	Blade	Length (in.)
MA612R	S/B	CVD	4 1/2

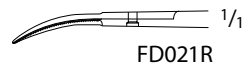
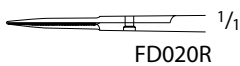
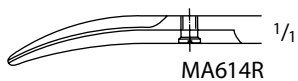
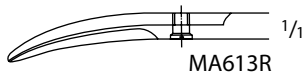
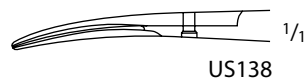
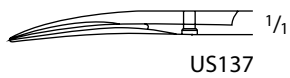
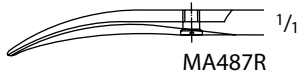

WESTCOTT Stitch and Utility Scissors

Catalog Number	Tip	Blade	Handle	Length (in.)
MA487R	S/S	CVD	FLAT, SERR	5 1/2
US137	S/S	CVD	FLAT, SERR	4 1/2
US138	B/B	CVD	FLAT, SERR	4 1/2

WESTCOTT Tenotomy Scissors

Catalog Number	Tip	Blade	Handle	Length (in.)
MA613R	B/B	CVD, RIGHT HAND	FLAT, SERR	4 3/4
MA614R	B/B	CVD, LEFT HAND	FLAT, SERR	4 3/4

MILLES I Micro Scissors

Catalog Number	Tip	Blade	Handle	Length (in.)
FD020R	S/S	STR, SERR	FLAT, SERR	6 1/4
FD021R	S/S	CVD, SERR	FLAT, SERR	6 1/4

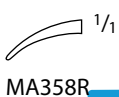
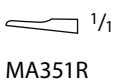
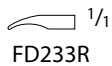
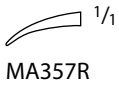
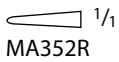
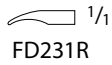
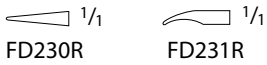
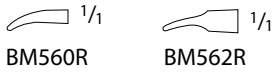

BARRAQUER Micro Needle Holder,
 Round Knurled Handle W/O Catch

Catalog Number	Tip	Length (in.)
FD230R	STR	4 3/4
MA352R	STR	5 1/4
BM562R	CVD, DEL	4 3/4
MA360R	CVD	4 1/4
BM560R	CVD	4 1/2
FD231R	CVD	4 3/4
MA357R	CVD	5 1/4

BARRAQUER Micro Needle Holder,
 Round Knurled Handle W/ Catch

Catalog Number	Tip	Length (in.)
FD232R	STR	4 3/4
MA351R	STR	5 1/4
FD233R	CVD	4 3/4
MA358R	CVD	5 1/4



MA353R

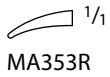

MA353R



MA354R

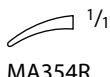

MA354R



MA355R-MA356R

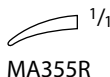

MA355R



MA356R



MA364R-MA366R, MA368R



MA364R

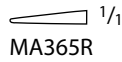

MA365R



MA366R

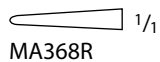

MA368R



MA363R, MA367R



MA367R



MA363R



MA628R



MA628R

COHEN Micro Needle Holder, Round Knurled Handle

Catalog Number	Tip	Handle	Length (in.)
MA353R	CVD	W/O CATCH	4 1/8
MA354R	CVD	W/ CATCH	4 1/8

TROUTMAN Micro Needle Holder, Flat Handle W/ Catch

Catalog Number	Tip	Length (in.)
MA355R	CVD	4 3/4
MA356R	CVD	5 1/8

CASTROVIEJO Micro Needle Holder, Flat Handle

Catalog Number	Tip	Jaw Length (mm)	Handle	Length (in.)
MA365R	STR	9	W/ CATCH	5 1/2
MA366R	STR	9	W/ CATCH	5 1/8
MA368R	STR	16	W/ CATCH	5 7/8
MA364R	STR	10	W/ CATCH	5 3/8
MA367R	STR	10	W/O CATCH	5 3/8
MA363R	CVD	10	W/O CATCH	5 3/8

Micro Needle Holder, Round Knurled Handle W/O Catch

Catalog Number	Tip	Length (in.)
MA628R	DEL, CVD	4 3/4



FD242R-FD243R

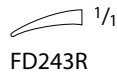
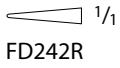

Micro Needle Holder, Round Knurled Handle W/ Catch

Catalog Number	Tip	Length (in.)
FD242R	STR	6
FD243R	CVD	6



MA907R



HAMPTON Micro Needle Holder, Heavy Jaw, Round Knurled Handle W/ Catch

Catalog Number	Tip	Length (in.)
MA907R	CVD	5 1/8



MA908R, MA911R



MA909R-MA910R

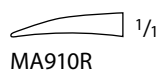
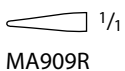

MCPHERSON Micro Needle Holder, Flat Handle, Delicate

Catalog Number	Tip	Handle	Length (in.)
MA908R	STR	SERR W/ CATCH	4 1/4
MA909R	STR	FENESTRATED W/O CATCH	4 1/4
MA911R	CVD	SERR W/O CATCH	4 1/8
MA910R	CVD	FENESTRATED W/ CATCH	4 1/8

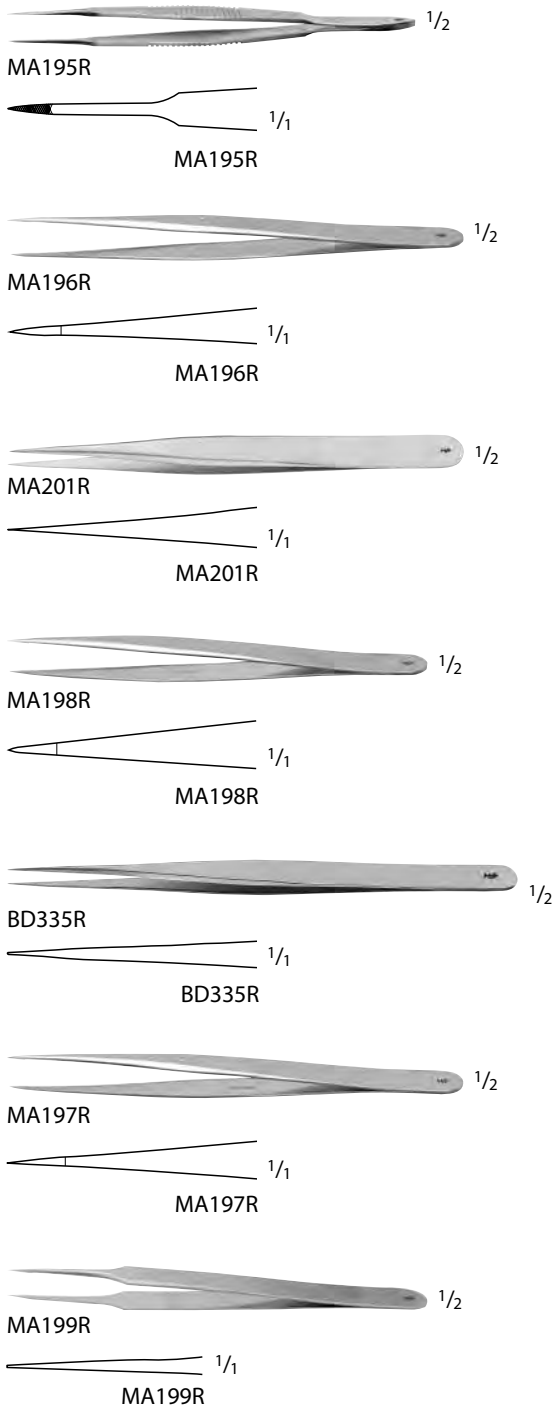

Micro Jewelers Forceps

Catalog Number	Tip	Tip Size (mm)	Tip Size (#)	Length (in.)
MA195R	STR, W/ PLATFORM, X-SERR	3	-	4 1/4
MA196R	STR, FINE, W/ PLATFORM	6	1	4 3/4
MA201R	STR, FINE	-	1	4 3/4
MA198R	STR, X-FINE, W/ PLATFORM	5	3	4 3/8
BD335R	STR	0.3	3	5 1/4
MA197R	STR, X-FINE, W/ PLATFORM	5	3	4 3/4
MA199R	STR, X-FINE, W/ PLATFORM	6	4	4 3/8
BD330R	STR	0.2	4	4 1/4
MA200R	STR, X-FINE, W/ PLATFORM	6	5	4 3/8
BD331R	STR	0.15	5	4 1/4
BD333R	CVD	0.20	5	4 1/2

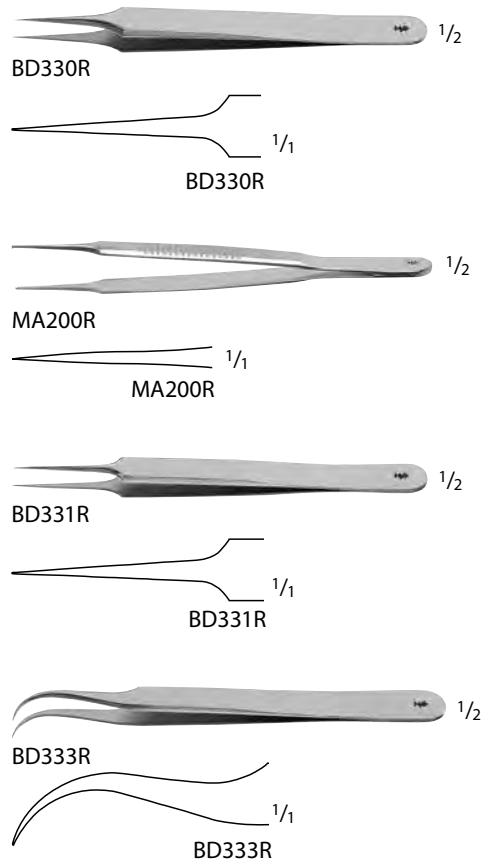

Let Us know if you could not find what you are looking for



BD320R



BD321R

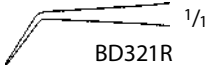

MA893R



BD336R



BD337R



OC020R-OC022R

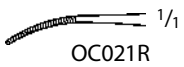
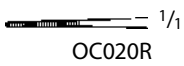

OC024R-OC026R

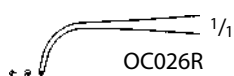
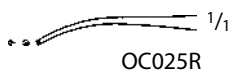
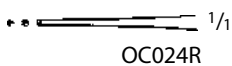

Micro Forceps

Catalog Number	Tip	Jaw	Length (in.)
BD320R	STR	SMOOTH	4
BD321R	ANG	SMOOTH	4

BARRAQUER Cilia Forceps

Catalog Number	Tip	Tip Size (mm)	Length (in.)
MA893R	SLIGHT-ANG	6	4 1/9

WISE Micro Suture Forceps W/ Platform

Catalog Number	Tip	Tip Size (mm)	Length (in.)
BD336R	STR	0.3	5 1/4
BD337R	CVD	0.3	5 1/4

Iris Forceps, Delicate

Catalog Number	Tip	Jaw	Length (in.)
OC020R	STR	SERR	4
OC021R	CVD	SERR	4
OC022R	HEAVY-CVD	SERR	4

Iris Forceps, X-Fine

Catalog Number	Tip	Teeth	Length (in.)
OC024R	STR	1 x 2	4
OC025R	CVD	1 x 2	4
OC026R	HEAVY-CVD	1 x 2	4



OC051R

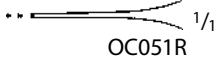

OC051R



MD580



MD580



OC091R

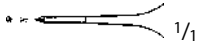

1/1



1/1

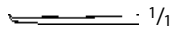

1/1

OC091R



OC094R

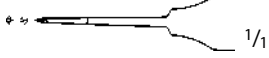

1/1

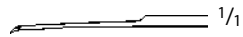

1/1



1/1

OC094R



US133



US133

BISHOP-HARMON Iris Forceps

Catalog Number	Teeth	Jaw	Length (in.)
OC051R	1 x 2	-	3 1/4
MD580	-	SERR	3 1/2

ST. MARTIN Tissue Forceps, Delicate

Catalog Number	Teeth	Length (in.)
OC091R	1 x 2	3 1/8

CASTROVIEJO Tissue Forceps, Delicate

Catalog Number	Tip Size (mm)	Teeth	Length (in.)
OC094R	0.9	1 x 2	4

CASTROVIEJO Fixation Forceps,
 W/O Platform

Catalog Number	Tip Size (mm)	Teeth	Length (in.)
US133	0.5	1 x 2	4 1/4



MA148R-MA149R



MA148R



MA149R



MA150R

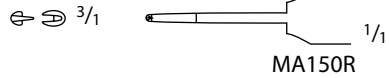

MA150R



US136



US136



MA151R

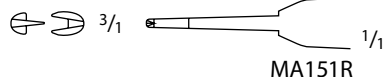

MA151R



MA152R

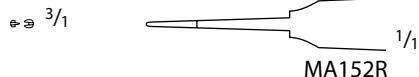

MA152R



MA153R

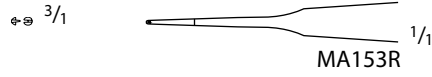

MA153R



MA158R

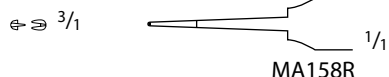

MA158R



MB295R

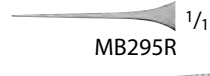

MB295R



MB477R



MB477R



MA154R



MA154R

CASTROVIEJO Suture Forceps,
 W/ 1 x 2 Teeth

Catalog Number	Tip	Tip Size (mm)	Platform	Handle	Length (in.)
MB295R	STR	0.12	YES	SERR	4 1/8
MA153R	STR	0.12	YES	SERR	4 3/8
MA152R	STR	0.22	YES	SERR	4 1/4
MA158R	STR	0.3	YES	SERR	4 1/8
MB477R	STR	0.3	YES	SERR	4 3/8
MA148R	STR	0.5	YES	WIDE	4 1/4
MA150R	STR	0.5	YES	SERR	4 1/4
US136	STR	0.5	NO	WIDE W/ LOCK	4 1/4
MA151R	STR	0.9	YES	SERR	4 1/4
MA149R	STR	1.5	YES	WIDE	4 1/4
MA154R	ANG 45°	0.5	YES	SERR	4 1/4

Let Us know if you could not find what you are looking for



MA618R



MA618R



MB294R



MB294R



BD505R

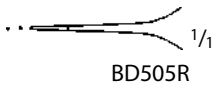

BD505R



OC100R



OC100R



FD280R-FD281R

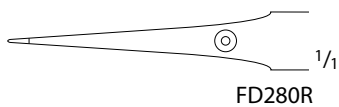

FD280R

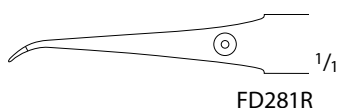

FD281R



MA875R



MA875R

CASTROVIEJO Capsule Forceps,
 Cross-Action

Catalog Number	Tip	Length (in.)
MA618R	10 MM FROM ANGLE TO TIP	4 1/8

CASTROVIEJO Colibri Type Corneal
 Forceps

Catalog Number	Tip Size (mm)	Teeth	Length (in.)
MB294R	0.12	1 x 2	4 1/8

BONN Eye Forceps, W/ Platform

Catalog Number	Tip Size (mm)	Teeth	Length (in.)
BD505R	0.2	1 x 2	3 3/4

GRAEFE Tissue Forceps

Catalog Number	Length (in.)
OC100R	4 1/4

Suture Tying Forceps, W/ Platform

Catalog Number	Tip	Tip Size (mm)	Length (in.)
FD280R	STR	0.3	4 3/4
FD281R	CVD	0.3	4 3/4

OSHER-ELSCHNIG Forceps,
 W/ Platform

Catalog Number	Tip	Tip Size (mm)	Teeth	Length (in.)
MA875R	0.12	3	1 x 2	4 1/8



MA160R-MA161R

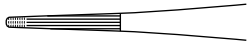

MA160R-MA161R



MA876R

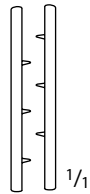
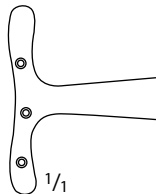

MA876R



MA886R

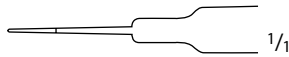

MA886R



MA885R



MA885R

BONACCOLTO Utility Forceps

Catalog Number	Tip Size (mm)	Length (in.)
MA160R	1.2 x 16	4 1/4
MA161R	1.7 x 17	4 1/4

PUTTERMAN-Type Muscle Forceps, W/ Lock

Catalog Number	Tip	Jaw	Length (in.)
MA876R	6 PINS	SERR	4

TENNANT Tying Forceps, W/ Platform

Catalog Number	Tip	Tip Size (mm)	Jaw	Handle	Length (in.)
MA886R	X-DEL	6	SMOOTH	ROUND	4 1/4

SINSKEY Tying Forceps

Catalog Number	Tip	Jaw	Handle	Length (in.)
MA885R	X-DEL	SMOOTH, CVD	FLAT, WIDE SERR	4



MA891R



MA892R



MA896R



MA898T



MA538R

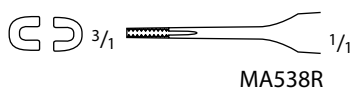

SHEPARD Lens Holding Forceps,
 Cross-Action

Catalog Number	Tip	Jaw	Handle	Length (in.)
MA891R	DUCKBILL	CVD	FLAT, WIDE SERR	5

CLAYMAN Lens Holding Forceps,
 Cross-Action

Catalog Number	Tip	Jaw	Handle	Length (in.)
MA892R	DEL, ANG	CVD	FLAT, WIDE SERR	4 3/4

Scleral Plug Forceps, Cross-Action

Catalog Number	Tip	Tip Size (mm)	Jaw	Handle	Length (in.)
MA896R	CVD	9	ANG	FLAT, SERR	4 1/8

DEVGAN Titanium Capsulorhexis
 Forceps, Cross-Action

Catalog Number	Tip	Handle	Length (in.)
MA898T	X-DEL, SEMI-SHARP	ROUND	5

GRIFFITHS-BROWN Tissue Forceps

Catalog Number	Tip	Length (in.)
MA538R	DEL	4 1/4

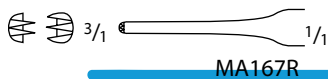
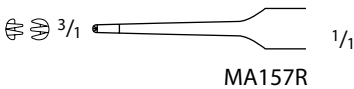

BONN Suture Forceps, W/ Platform

Catalog Number	Tip Size (mm)	Teeth	Length (in.)
MA155R	0.12	1 x 2	3 3/4

BONN Tissue Forceps

Catalog Number	Tip Size (mm)	Teeth	Length (in.)
MA878R	0.12	1 x 2	3 3/4

THORPE Conjunctival Fixation Forceps, W/ Platform

Catalog Number	Teeth	Length (in.)
MA157R	2 x 3	3 3/4

THORPE Corneal Forceps W/ Platform

Catalog Number	Tip Size (mm)	Jaw	Teeth	Length (in.)
MA901R	0.12	STR	2 x 3, ANG 45°	3 3/4

LESTER Fixation Forceps

Catalog Number	Teeth	Length (in.)
MA166R	FINE, 1 x 2	3 3/4
MA167R	FINE, 2 x 3	3 3/4



MA170R-MA171R



MA170R

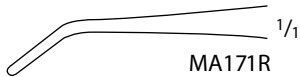

MA171R



MA902R

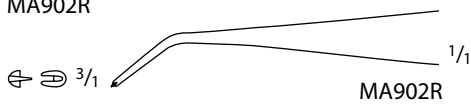

MA902R



MA316R-MA317R



MA316R-MA317R



MA548R



MA881R

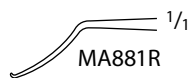

MA881R



4/1

NUGENT Utility Forceps

Catalog Number	Jaw	Jaw Length (mm)	Length (in.)
MA170R	SERR, ANG 45°	10	4 1/4
MA171R	SMOOTH, ANG 45°	10	4 1/4

TROUTMAN Superior Rectus Forceps

Catalog Number	Tip Size (mm)	Jaw	Teeth	Length (in.)
MA902R	10	ANG	1 x 2	4 1/8

BERKE Ptosis Forceps, W/ Lock

Catalog Number	Jaw Length (mm)	Length (in.)
MA316R	20	4
MA317R	27	4 1/8

Serrefine Clamp

Catalog Number	Tip	Jaw	Jaw Length (mm)	Length (in.)
MA548R	STR	SERR	10	1 3/8

LEHNER-UTRATA Capsulotomy Forceps

Catalog Number	Tip	Tip Size (mm)	Length (in.)
MA881R	ANG	12	3 1/2

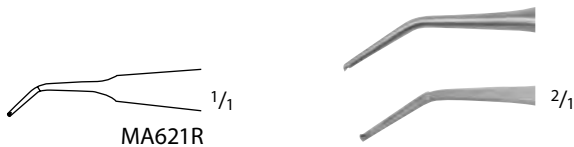
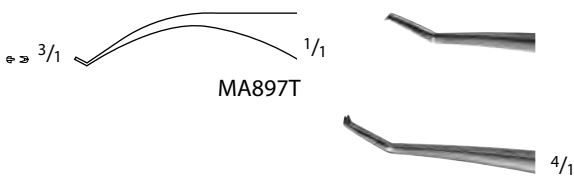
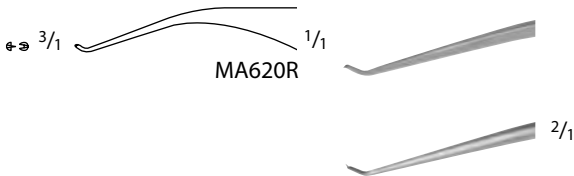
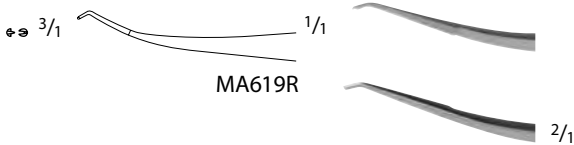

UTRATA Capsulorhexis Forceps

Catalog Number	Tip	Tip Size (mm)	Handle	Length (in.)
MA617R	ANG	12	FLAT, SERR	3 1/8
MG363R	ANG	11	FLAT, FENESTRATED	4

COLIBRI-Style Corneal Forceps, W/ Platform

Catalog Number	Tip	Tip Size (mm)	Teeth	Length (in.)
MA619R	ANG 50°	6	1 x 2	4 1/4

TROUTMAN-BARRAQUER Corneal Forceps

Catalog Number	Tip Size (mm)	Teeth	Length (in.)
MA620R	0.12	1 x 2	2 7/8

Titanium COLIBRI Forceps

Catalog Number	Tip Size (mm)	Jaw	Teeth	Length (in.)
MA897T	0.12	SMOOTH	1 x 2	3

MCPHERSON Angled Corneal Suturing Forceps, W/ Platform

Catalog Number	Tip	Tip Size (mm)	Teeth	Length (in.)
MA621R	ANG 45°	5	1 x 2	3 3/8

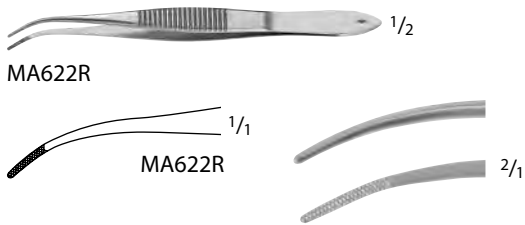

MA622R

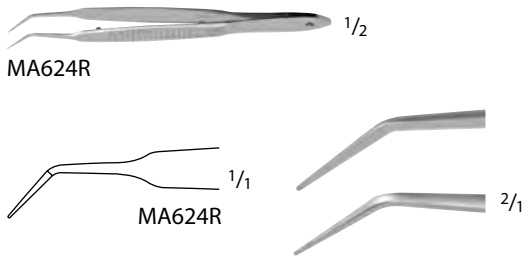

MA624R

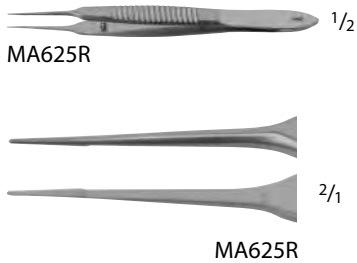

MA625R

MA625R

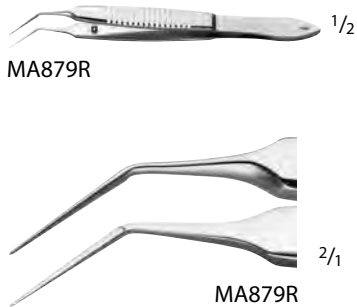

MA879R

MA879R

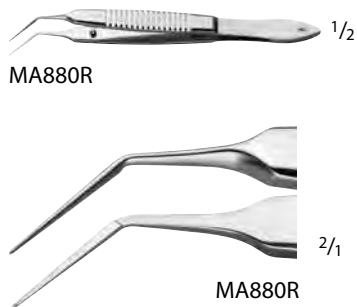

MA880R

MA880R

BRACKEN Iris Forceps

Catalog Number	Tip	Jaw	Length (in.)
MA622R	CVD	CROSS-SERR	3 7/8

KELMAN-MCPHERSON Forceps, W/ Platform

Catalog Number	Tip	Tip Size (mm)	Length (in.)
MA624R	ANG 45°	8.5	3 3/8

MCPHERSON Forceps, W/ Platform

Catalog Number	Tip	Tip Size (mm)	Length (in.)
MA625R	STR	5	3 1/4

BECHERT-MCPHERSON Forceps

Catalog Number	Tip	Tip Size (mm)	Jaw	Length (in.)
MA879R	ANG	10	SMOOTH	3 1/4

SHEETS-MCPHERSON Forceps

Catalog Number	Tip	Tip Size (mm)	Jaw	Length (in.)
MA880R	1 MM X-SERR	10	ANG	3 1/4



MA626R



MA626R



MA726R

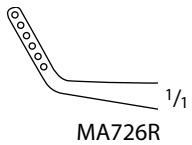

MA726R



MA623R



MA623R



MA899R



MA899R



MA900R



MA900R

JAMESON Muscle Forceps, W/ Lock

Catalog Number	Tip Size (mm)	Jaw	Length (in.)
MA626R	12	ANG, LEFT	3 3/8
MA726R	12	ANG, RIGHT	4

MCCULLOUGH Utility Forceps

Catalog Number	Tip	Tip Size (mm)	Jaw	Length (in.)
MA623R	STR	15	SMOOTH	3 5/8

Tying Forceps

Catalog Number	Jaw	Handle	Length (in.)
MA899R	SMOOTH	FLAT, SERR	4 1/4

Alabama University Forceps, W/ Platform

Catalog Number	Tip	Tip Size (mm)	Length (in.)
MA900R	V-GROOVED	15	3 1/2



MA882R



MA882R



MA883R



MA883R



MA877R



MA877R



MA884R



MA884R

Von GRAEFE Iris Forceps

Catalog Number	Tip	Teeth	Length (in.)
MA882R	STR	1 x 2	3

GILL Iris Forceps

Catalog Number	Tip	Jaw	Length (in.)
MA883R	CVD	CROSS-SERR	3

WILLS Hospital Utility Forceps

Catalog Number	Tip	Jaw	Length (in.)
MA877R	STR	SERR	4

WATZKE Sleeve Spreading Forceps

Catalog Number	Tip	Jaw Length (mm)	Length (in.)
MA884R	ANG	10	4 3/4

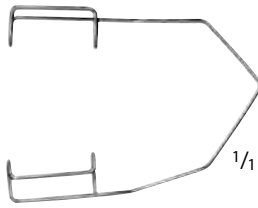

OA200R

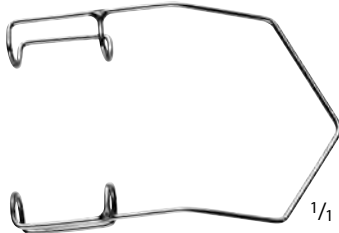

MA752R



MA754R



MA751R

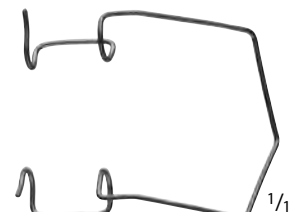
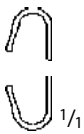

MA756R

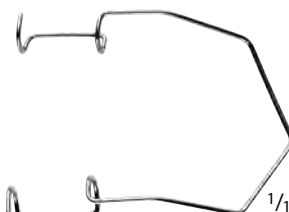

MA755R

BARRAQUER Eye Speculum

Catalog Number	Blade Size (mm)	Frame	Length (in.)
MA751R	10	WIRE	1 1/2
OA200R	10	WIRE	1 3/4
MA752R	14	HEAVY WIRE	1 3/4
MA754R	15	SOLID	1 3/4

KRATZ-BARRAQUER Eye Speculum

Catalog Number	Blade Size (mm)	Blade Shape	Length (in.)
MA756R	10	PEDIATRIC	1 3/8
MA755R	14	ADULT	1 1/2



MA757R

ALPHONSO Speculum, Infant

Catalog Number	Blade Size (mm)	Length (in.)
MA757R	7 x 5 AND 9 WIDE	1 3/4



MA750R

LIEBERMAN Speculum, Adjustable

Catalog Number	Blade Size (mm)	Blade Shape	Length (in.)
MA750R	16	STR, SQUARE WIRE	3 1/8
MA758R	14	ANG, SQUARE WIRE	3 1/4
MA759R	14	ANG, V-SHAPE WIRE	3 1/4
MA760R	14	ANG, SOLID	3 1/4
MA764R	14	ANG, REVERSIBLE, SOLID	3 1/8



MA758R



MA759R



MA760R



MA764R



MA763R

JAFFE Wire Lid Retractor, Pair

Catalog Number	Blade Size (mm)	Length (in.)
MA763R	13	1 1/2
MA762R	15	1 1/2



MA762R



OA218R

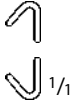

OA218R



MA638R



MA638R



OA225R

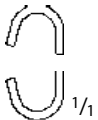

OA225R



BV013R



BV013R

SAUER Eye Speculum

Catalog Number	Length (in.)
OA218R	1 3/8

LANCASTER Eye Speculum

Catalog Number	Length (in.)
MA638R	2 3/4
OA225R	3 1/8

LOGAN Modified REILL Self-Retaining Retractor

Catalog Number	Length (in.)
BV013R	2



MA434R-MA437R

SEWALL Orbital Retractor

Catalog Number	Blade Size (mm)	Length (in.)
MA434R	7 x 52	6 3/4
MA435R	9 x 44	6 3/8
MA436R	11 x 50	6 3/8
MA437R	13 x 67	6 3/4

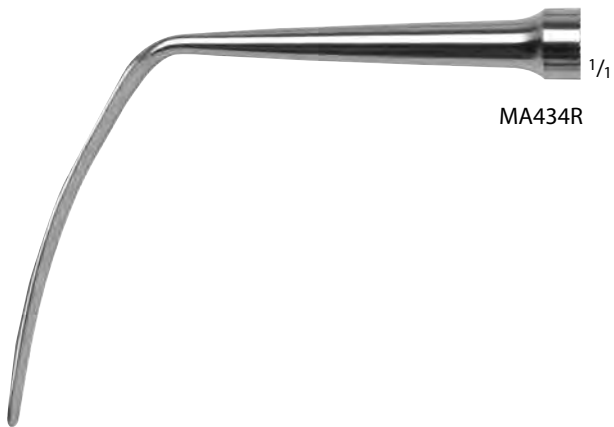

MA434R



MA435R



MA436R



MA437R



OA310R-OA314R

DESMARRES Lid Retractor

Catalog Number	Blade Size (mm)	Length (in.)
OA310R	9 x 9	5 1/2
OA311R	9 x 12	5 1/2
OA312R	11 x 14	5 1/2
OA313R	12 x 16	5 1/2
OA314R	13 x 18	5 1/2

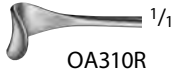

OA310R

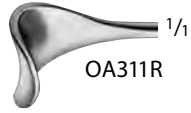

OA311R

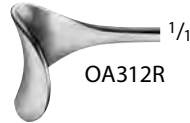

OA312R



OA313R



OA314R



MA749R

SCHEPENS Orbital Retractor

Catalog Number	Tip	Blade Size (mm)	Length (in.)
MA749R	SMOOTH	14 x 61	6 1/8



MA765

JAEGER Lid Plate, Clear Plastic

Catalog Number	Blade Size (mm)	Length (in.)
MA765	20/23	3 3/4



MA766R

BERKE-JAEGER Lid Plate

Catalog Number	Blade Size (mm)	Length (in.)
MA766R	20/30	4 1/4



MA731R

WELLS Enucleation Spoon

Catalog Number	Diameter (mm)	Length (in.)
MA731R	21	5 3/4



MA744R-MA745R



MA744R



MA745R

BUNGE Evisceration Spoon

Catalog Number	Tip	Diameter (mm)	Length (in.)
MA744R	SMALL	8	5 1/4
MA745R	LARGE	12	5 1/2



MA761R

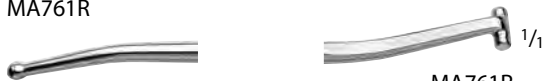

MA761R

SCHOCKET Scleral Depressor, Double Ended

Catalog Number	Length (in.)
MA761R	5 1/4



MA747R



MA747R

FLYNN Scleral Depressor

Catalog Number	Diameter (mm)	Length (in.)
MA747R	5	3 1/8



WHITMAN-SHEPHERD Capsule
 Polisher, Double Ended

Catalog Number	Tip	Length (in.)
MA777R	LEFT ANG, RIGHT ANG	5 1/8

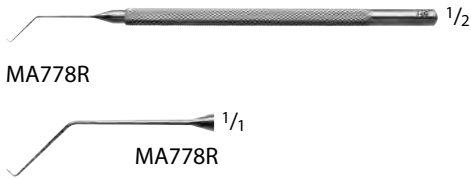

KOCH Stop and Chop Manipulator,
 Angled Shaft

Catalog Number	Tip Size (mm)	Length (in.)
MA778R	1.5	4 3/4

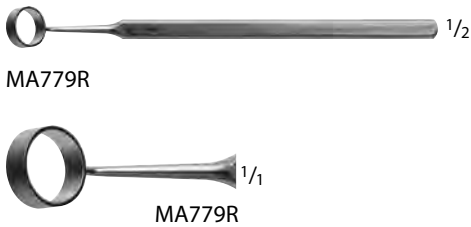

CAMELLIN Style LASIK Alcohol Well

Catalog Number	Diameter (mm)	Length (in.)
MA779R	8.5	4 1/2

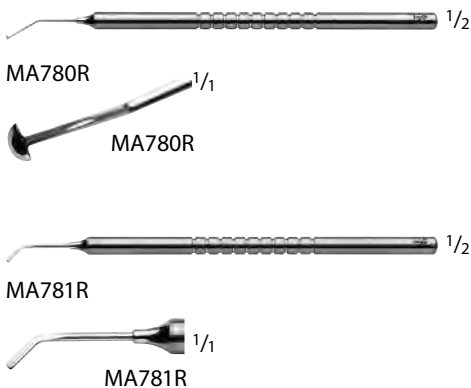

SLOANE LASIK Spatula

Catalog Number	Tip	Description	Length (in.)
MA780R	SEMI-CIRCULAR, BEVELED EDGE	MICRO HOE	4 1/2
MA781R	SEMI-SHARP	EPI PEELER	4 1/2

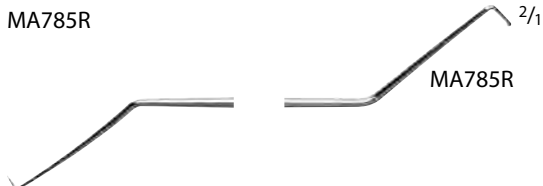

CHANG-SEIBEL Phaco Chopper, Double Ended

Catalog Number	Tip	Style	Length (in.)
MA782R	ANG C-SHAPED BLUNT CHOPPER / VERTICAL SAFETY CHOPPER	F/ LEFT HAND	5 1/2

KOCH Nucleus Spatula

Catalog Number	Tip	Tip Size (mm)	Length (in.)
MA783R	SLIGHTLY CVD W/ DUCKBILL TIP	1	4 1/2

LIEBERMAN Nucleus Manipulator

Catalog Number	Style	Shaft	Length (in.)
MA784R	F/ LEFT HAND	ANG	4 1/2

CHANG Combo Phaco Chopper, Double Ended

Catalog Number	Tip	Style	Shaft	Length (in.)
MA785R	C-SHAPED BLUNT CHOPPER / 1.3 MM SHARP QUICK CHOP TIP	F/ LEFT HAND	ANG	5 1/4

NAGAHARA Nucleus Spatula

Catalog Number	Tip	Style	Shaft	Length (in.)
MA786R	FLAT INTERIOR EDGE	F/ LEFT HAND	ANG	4 1/4



MA789R



MA789R



MA790R



MA790R



MA791R



MA791R



MA792R



MA792R



MA793R



MA793R

BECHERT Nucleus Rotator

Catalog Number	Tip	Shaft	Length (in.)
MA789R	Y-SHAPED	ANG 45° 7 MM FROM TIP	4 3/4

JAFFE-BECHERT Nucleus Rotator

Catalog Number	Tip	Shaft	Length (in.)
MA790R	Y-SHAPED	ANG 45° 9 MM FROM TIP	4 3/4

DRYSDALE Nucleus Manipulator

Catalog Number	Tip	Length (in.)
MA791R	PADDLE-SHAPED	4 1/4

PISACANO Nucleus Rotator

Catalog Number	Tip	Length (in.)
MA792R	VERTICAL FLAT	4 1/4

ANIS-WAND Nucleus Manipulator

Catalog Number	Tip	Tip Size (mm)	Shaft	Length (in.)
MA793R	BALL-SHAPED	0.5	STR	4 3/4

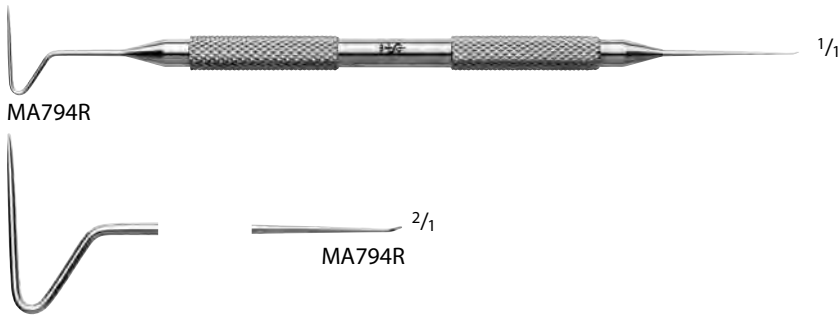

SIEBEL Flap Lifter and Spatula, Double Ended

Catalog Number	Tip	Length (in.)
MA794R	Z-SHAPED AND 1.5 MM ANG POINT	4 1/8

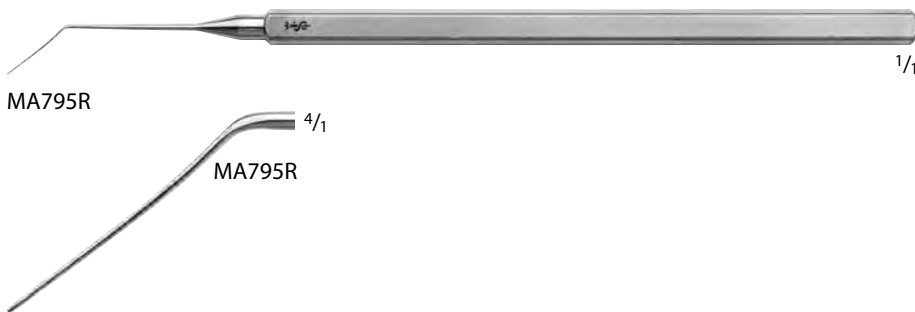

JAFFE Lens Spatula

Catalog Number	Tip	Tip Size (mm)	Length (in.)
MA795R	FLAT	0.5	4 3/4

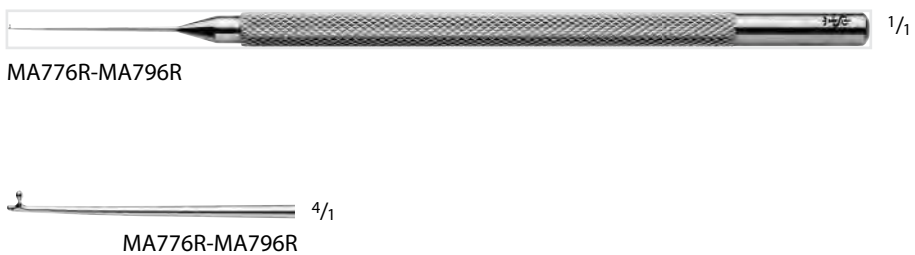

LESTER IOL Manipulator

Catalog Number	Tip	Tip Size (mm)	Shaft	Length (in.)
MA776R	TEARDROP-SHAPED	0.25	STR	4 1/2
MA796R	TEARDROP-SHAPED	0.25	ANG	4 1/2

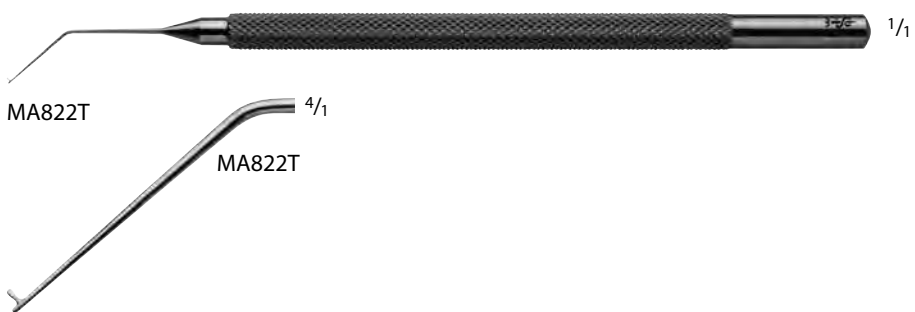

LESTER II Titanium IOL Manipulator

Catalog Number	Tip	Tip Size (mm)	Shaft	Length (in.)
MA822T	TEARDROP-SHAPED	0.20	ANG	4 1/2

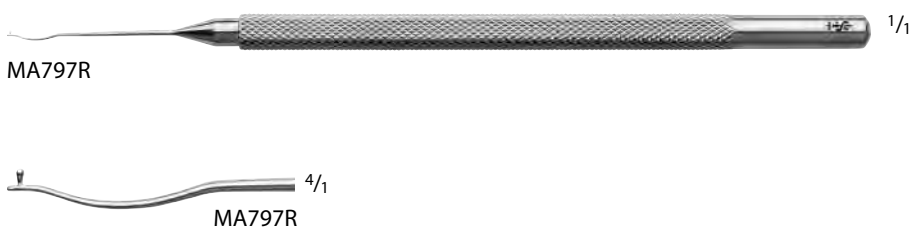

MALONEY IOL Manipulator

Catalog Number	Tip	Tip Size (mm)	Shaft	Length (in.)
MA797R	TEARDROP-SHAPED	0.25	CVD	4 1/2

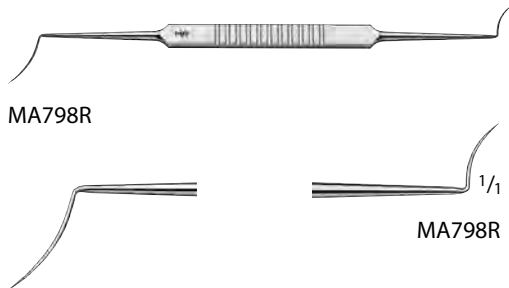
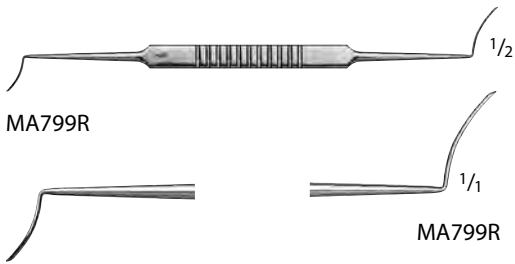
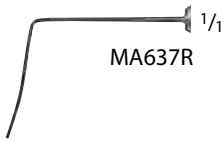

BARRAQUER Cyclodialysis Spatula

Catalog Number	Blade Size (mm)	Blade	Length (in.)
MA637R	0.5 x 15	ANG	4 7/8

CASTROVIEJO Cyclodialysis Spatula, Double Ended

Catalog Number	Blade Size (mm)	Length (in.)
MA799R	0.5 x 10 / 0.5 x 15	5 1/8

CASTROVIEJO Synechia Spatula, Double Ended

Catalog Number	Blade Size (mm)	Length (in.)
MA798R	0.5	5 1/4

MA798R

NEW ORLEANS Lens Loop

Catalog Number	Tip	Length (in.)
MA823R	4 x 10	5 1/2

PATON Spatula and Spoon, Double Ended

Catalog Number	Tip	Length (in.)
MA801R	6 MM WIDE GROOVED SPOON / 1.5 MM FLAT BLADE ANG AT 8 MM	5 1/2



MA803R



MA803R



MA805R



MA805R



MA806R



MA806R



MA630R



MA630R



MA824R



MA824R



MA804R



MA804R



MA807R



MA807R



MA808R



MA808R

GRAETHER Collar Button

Catalog Number	Tip	Shaft	Length (in.)
MA803R	0.6 MM BUTTON	ANG 45° 10 MM FROM TIP	4 3/4

CLAYMAN-JAFFE Lens Hook

Catalog Number	Tip	Tip Size (mm)	Shaft	Length (in.)
MA805R	ANG 90° BLUNT	0.15	ANG 45° 10 MM FROM TIP	4 1/2

HARRS-SINSKEY Lens Manipulating Hook

Catalog Number	Tip	Tip Size (mm)	Shaft	Handle	Length (in.)
MA806R	BLUNT	0.25	ANG 45° 10 MM FROM TIP	FLAT	4 1/2

SINSKEY Lens Manipulating Hook

Catalog Number	Tip	Tip Size (mm)	Shaft	Handle	Length (in.)
MA630R	BLUNT	0.25	STR	FLAT	4 5/8
MA824R	BLUNT	0.20	MODIFIED CVD	FLAT	4 1/2
MA804R	BLUNT, REVERSE	0.20	ANG	FLAT	4 1/2
MA807R	BLUNT	0.25	STR	ROUND	4 1/2
MA808R	BLUNT	0.25	ANG	ROUND	4 1/2

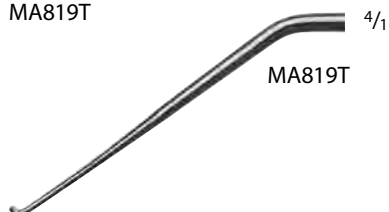
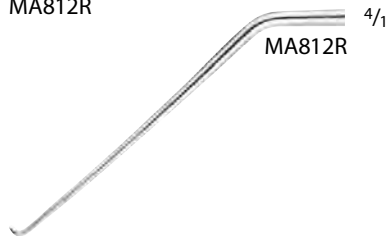

SINSKEY II Lens Manipulating Hook

Catalog Number	Tip	Tip Size (mm)	Shaft	Handle	Length (in.)
MA809R	BLUNT	0.2	STR	FLAT	4 1/2
MA810R	BLUNT	0.2	ANG	FLAT	4 1/2
MA811R	BLUNT	0.2	STR	ROUND	4 1/2
MA812R	BLUNT	0.2	ANG	ROUND	4 1/2

SINSKEY II Titanium Lens Manipulating Hook

Catalog Number	Tip	Tip Size (mm)	Shaft	Handle	Length (in.)
MA825T	BLUNT	0.2	STR	FLAT	4 1/2
MA819T	BLUNT	0.2	ANG	ROUND	4 1/2



MA631R



MA631R



MA813R-MA814R



MA813R



MA814R



MA815R-MA816R



MA815R



MA816R



MA827T



MA827T



MA826T



MA826T

KUGLEN Iris Hook and Lens Manipulator

Catalog Number	Tip	Tip Size (mm)	Shaft	Handle	Length (in.)
MA631R	K-HOOK	0.5	STR	SQUARE	4 5/8
MA813R	PUSH-PULL	-	STR	FLAT	4 1/2
MA814R	PUSH-PULL	-	ANG	FLAT	4 1/2
MA815R	PUSH-PULL	-	STR	ROUND	4 1/2
MA816R	PUSH-PULL	-	ANG	ROUND	4 1/2

KUGLEN Titanium Iris Hook and Lens Manipulator

Catalog Number	Tip	Shaft	Handle	Length (in.)
MA827T	K-HOOK	STR	ROUND	4 1/2
MA826T	PUSH-PULL	ANG	ROUND	4 1/2

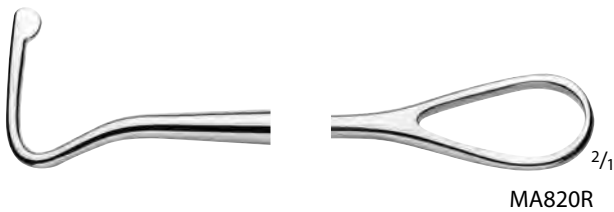
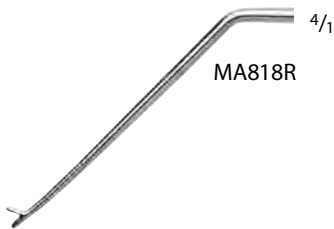

OSHER "Y"-Hook Lens Manipulator

Catalog Number	Tip	Shaft	Length (in.)
MA817R	Y-SHAPED	STR	4 1/2

JAFFE-MALTZMAN Lens Manipulating Hook

Catalog Number	Tip	Tip Size (mm)	Shaft	Length (in.)
MA818R	V-SHAPED	0.15	ANG	4 1/2

MCPHERSON Iris Spatula

Catalog Number	Blade Size (mm)	Length (in.)
MA775R	1 x 16	4 1/2

KIRBY Hook and Muscle Loop, Double Ended

Catalog Number	Blade Size (mm)	Length (in.)
MA820R	5 x 10	6 1/8

BONN Micro Iris Hook

Catalog Number	Tip	Shaft	Length (in.)
MA821R	BLUNT	STR	5



MA632R



MA632R



MA828R

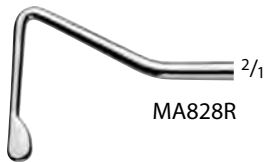

MA828R



MA633R



MA633R



MA634R



MA634R

JAMESON Muscle Hook

Catalog Number	Size	Tip Size (mm)	Length (in.)
MA632R	SMALL	9	5 1/4
MA828R	LARGE	10	5 1/4

GREEN Strabismus Hook

Catalog Number	Tip	Tip Size (mm)	Length (in.)
MA633R	FLAT	8	5 1/8

Twist Fixation Hook

Catalog Number	Tip	Length (in.)
MA634R	RIGHT, CLOCKWISE TWIST	4 1/4



MA635R



MA635R



MA636R



MA636R



MA800R

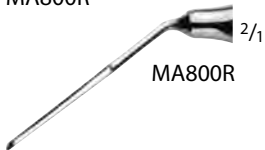

MA800R



MA194R



MA194R

GASS Retinal Detachment Hook

Catalog Number	Length (in.)
MA635R	5 5/8

STEVENS Tenotomy Hook

Catalog Number	Tip	Tip Size (mm)	Length (in.)
MA636R	CVD, BLUNT	5	4 5/8

ALFONSO Nucleus Trisector

Catalog Number	Tip Size (mm)	Length (in.)
MA800R	1.5	4 3/4

TYRELL Iris Hook

Catalog Number	Tip	Tip Size (mm)	Length (in.)
MA194R	SHARP	2	4 3/4



MA732R-MA742R

FLIERINGA Scleral Fixation Ring

Catalog Number	Diameter (mm)	Description
MA743R	12-22	SET OF 8 RINGS
MA732R	12	-
MA733R	13	-
MA734R	14	-
MA735R	15	-
MA736R	16	-
MA737R	17	-
MA738R	18	-
MA739R	19	-
MA740R	20	-
MA741R	21	-
MA742R	22	-



MA975R



MA975R

OSHER-NEUMANN Corneal Marker

Catalog Number	Tip	Length (in.)
MA975R	8 BLADES	4 1/8



MA829R



MA829R

THORNTON Swivel Fixation Ring

Catalog Number	Tip	Diameter (mm)	Length (in.)
MA829R	BLUNT TEETH	13	4 1/2



MA833R



MA833R



MA836R



MA836R



MA834R



MA834R



MA835R



MA835R



MA837R



MA837R

MENDEZ Degree Gauge, Calibrated 10°
 from 0-180°

Catalog Number	Inner Diameter (mm)	Compatible w/	Length (in.)
MA833R	12	MA836R	4 1/4

BORES Axis Marker

Catalog Number	Compatible w/	Length (in.)
MA836R	MA833R	4

HENDERSON Degree Gauge

Catalog Number	Tip	Compatible w/	Length (in.)
MA834R	BEVELED FACE, SMOOTH	MA837R	4 1/8

For use with MA837R

HENDERSON Alignment Marker

Catalog Number	Tip	Compatible w/	Length (in.)
MA835R	BLUNT PIN MARKINGS AT 3, 6 AND 9 O'CLOCK	MA834R AND MA837R	4

For use with MA837R

HENDERSON Toric IOL Marker

Catalog Number	Tip	Compatible w/	Length (in.)
MA837R	2.5 MM AXIS MARKS	MA834R	4



MA838R-MA841R



MA838R



MA839R



MA840R



MA841R

BORES Optical Zone Marker

Catalog Number	Inner Diameter (mm)	Length (in.)
MA838R	3.5	4
MA839R	6	4 1/8
MA840R	7	4 1/8
MA841R	8	4 1/8



MA842R-MA846R



MA842R



MA843R



MA844R



MA845R

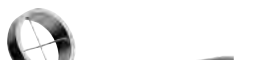

MA846R

HOFFER Optical Zone Marker

Catalog Number	Inner Diameter (mm)	Length (in.)
MA842R	4.25	4
MA843R	5	4
MA844R	5.5	4
MA845R	6	4
MA846R	8	4 1/8

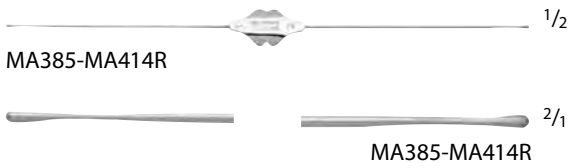

WILLIAMS Lacrimal Probe, Double Ended

Catalog Number	Tip Size (#)	Length (in.)
MA385	0000/000	5 1/8
MA410R	00/0	5 1/2
MA411R	1/2	5 1/2
MA412R	3/4	5 1/2
MA413R	5/6	5 1/2
MA414R	7/8	5 1/2

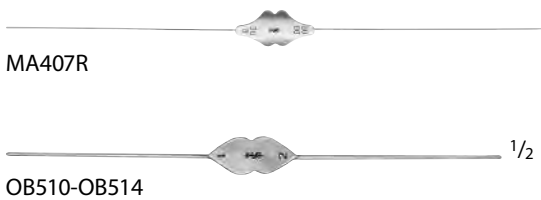

BOWMAN Lacrimal Probe, Double Ended

Catalog Number	Tip Size (#)	Tip Size (mm)	Description	Length (in.)
MA409	-	-	SET OF 6	-
MA407R	0000/000	-	-	5 5/8
OB510	00/0	0.7 / 0.8	-	5 1/8
OB511	1/2	0.9 / 1.1	-	5 1/8
OB512	3/4	1.3 / 1.4	-	5 1/8
OB513	5/6	1.5 / 1.6	-	5 1/8
OB514	7/8	1.8 / 1.9	-	5 1/8

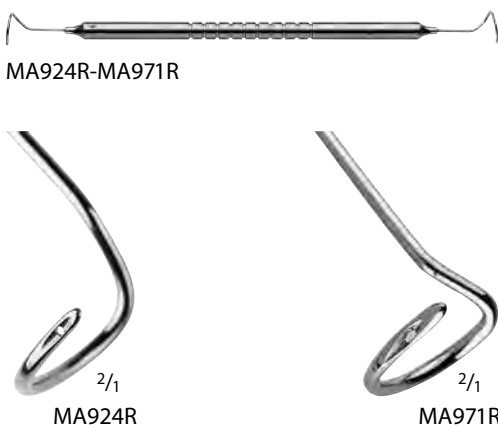

Pigtail Lacrimal Probe, Double Ended, W/ Suture Holes

Catalog Number	Tip	Diameter (mm)	Length (in.)
MA924R	BLUNT	8	5 1/8
MA971R	BLUNT	8	6 1/8

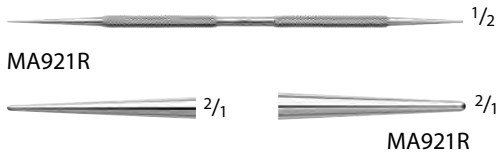

CASTROVIEJO Lacrimal Dilator, Double Ended

Catalog Number	Tip	Length (in.)
MA921R	FINE TAPPER/ MEDIUM TAPER	4 3/4

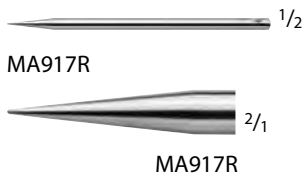

RUEDEMANN Lacrimal Dilator

Catalog Number	Tip	Length (in.)
MA917R	12 MM TAPER	2 3/4

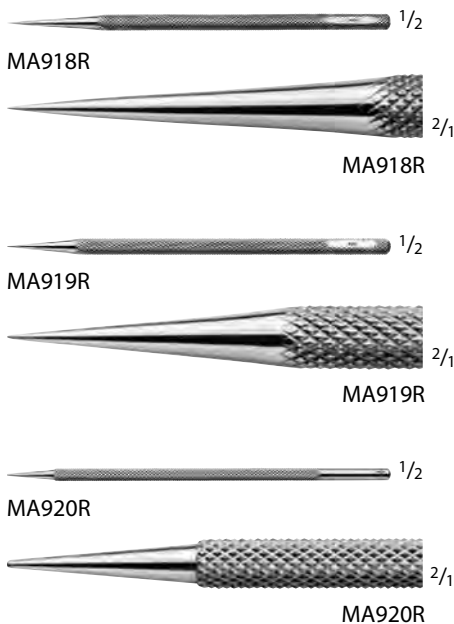

WILDER Lacrimal Dilator

Catalog Number	Tip	Tip Size (mm)	Size	Length (in.)
MA918R	LONG TAPER	23	1	4
MA919R	MEDIUM TAPER	18	2	4
MA920R	SHORT TAPER	13	3	4

CATALANO Lacrimal Intubation Set,
 Single Use

Catalog Number	Description
MA915R	TWO 0.7 MM PROBES ATTACHED TO 250 MM LONG SILICONE TUBING

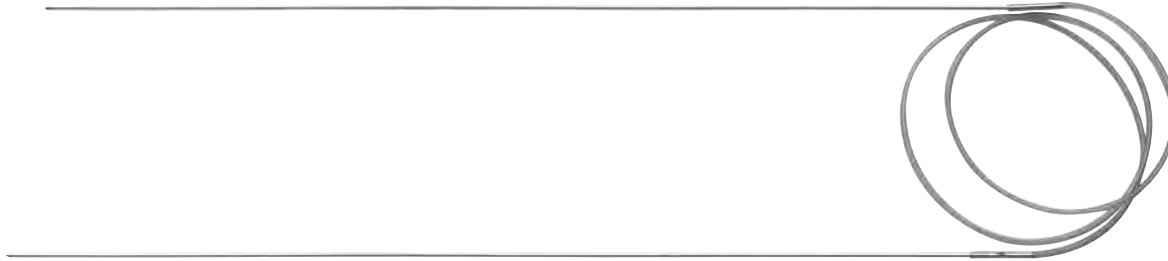

MA915R

JACKSON Lacrimal Intubation Set,
 Single Use

Catalog Number	Description
MA916R	TWO 0.9 MM PROBES ATTACHED TO 250 MM LONG SILICONE TUBING



MA916R

CRAWFORD Lacrimal Intubation Set,
 Single Use

Catalog Number	Description
MA922R	TWO OLIVE-TIPPED 0.8 MM PROBES ATTACHED TO 250 MM LONG SILICONE TUBING

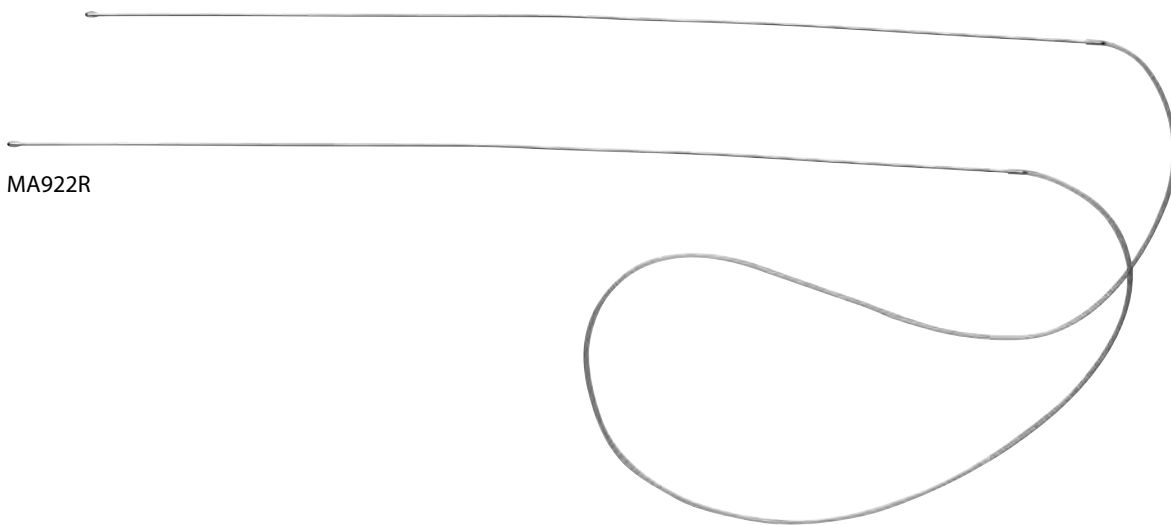

MA922R



MA923R



MA923R

CRAWFORD Retrieving Hook

Catalog Number	Compatible w/	Length (in.)
MA923R	MA922R	5 1/8

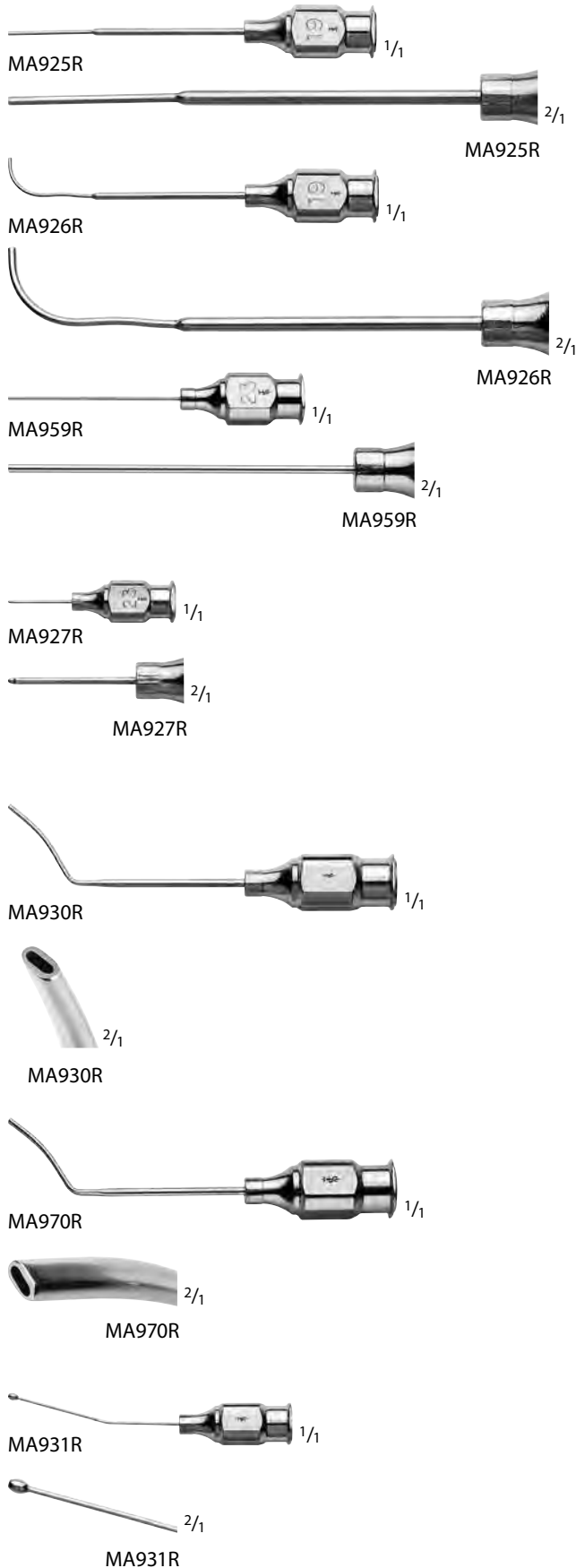

Lacrimal Cannula

Catalog Number	Tip	Tip Size (Gauge)	Shaft	Length (in.)
MA925R	REINFORCED MALLEABLE	23	STR	1 3/8
MA926R	REINFORCED MALLEABLE	23	CVD	1 3/8
MA959R	-	23	STR	1

SHAHINIAN Lacrimal Cannula

Catalog Number	Tip	Tip Size (Gauge)	Shaft	Length (in.)
MA927R	0.3 MM SIDE PORT	23	STR	3/8

RANDOLPH Cyclodialysis Cannula

Catalog Number	Tip	Tip Size (Gauge)	Shaft	Length (in.)
MA930R	THIN	19	ANG 13 MM FROM TIP	1 3/8
MA970R	DEL	19	ANG 13 MM FROM TIP	1 1/4

TROUTMAN Olive Tip Cannula

Catalog Number	Tip	Tip Size (Gauge)	Shaft	Length (in.)
MA931R	1	25	SLIGHT-CVD	1



JENSEN Capsule Polisher, Roughened Tip, W/ Front Opening

Catalog Number	Tip	Tip Size (Gauge)	Shaft	Length (in.)
MA932R	OLIVE	25	CVD	1
MA957R	OLIVE	27	CVD	1

KNOLLE Capsule Polisher, Roughened Tip

Catalog Number	Tip	Tip Size (Gauge)	Length (in.)
MA933R	2 MM ANG	30	3/4

BISHOP-HARMON Anterior Chamber Irrigator, 19 GA, Angled

Catalog Number	Description	Length (in.)
MA934R	COMPLETE SET	-
MA935	SILICONE BULB, 28 x 55 MM	-
MA936	PLASTIC ADAPTER, F/ USE W/ MA935	-
MA937R	CANNULA	1

MA934R Includes:
 1 Cannula MA937R
 1 Plastic Adaptor MA936
 1 Silicone Bulb MA935

Hydrodissection Cannula

Catalog Number	Tip	Tip Size (Gauge)	Shaft	Length (in.)
MA938R	FLATTENED, FRONT OPENING	25	ANG	3/4



MA939R



MA939R

BRACKEN Irrigating Cannula

Catalog Number	Tip	Tip Size (Gauge)	Shaft	Length (in.)
MA939R	FLATTENED BELEVED, FRONT OPENING	19	CVD	1 1/4



MA940R



MA940R

SLADE LASIK Cannula

Catalog Number	Tip	Tip Size (Gauge)	Shaft	Length (in.)
MA940R	FLATTENED SPATULA, FRONT OPENING	26	ANG	1/2



MA941R



MA941R

BURATTO Cannula

Catalog Number	Tip	Tip Size (Gauge)	Shaft	Length (in.)
MA941R	FLATTENED, 1 FRONT AND 2 SIDE PORTS	25	ANG	1

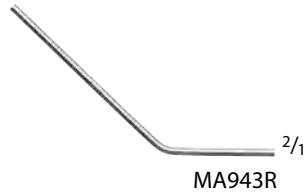

MCINTYRE Anterior Chamber Cannula

Catalog Number	Tip	Tip Size (Gauge)	Shaft	Length (in.)
MA962R	BLUNT	23	STR	3/4
MA963R	BLUNT	26	STR	3/4
MA964R	BLUNT	30	STR	3/4
MA942R	BLUNT	23	ANG 12 MM FROM TIP	3/4
MA943R	BLUNT	26	ANG 12 MM FROM TIP	3/4
MA944R	BLUNT	30	ANG 12 MM FROM TIP	3/4

SIMCOE Cortex Extractor, Side Port

Catalog Number	Tip	Tip Size (Gauge)	Shaft	Length (in.)
MA945R	SMOOTH, 0.3 MM	23	CVD	1/2
MA946R	ROUGHENED, 0.3 MM	23	CVD	1/2
MA947R	SMOOTH, 0.3 MM	23	CVD	3/4
MA948R	ROUGHENED, 0.3 MM	23	CVD	3/4

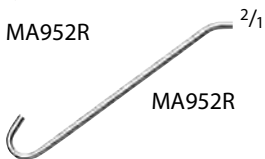
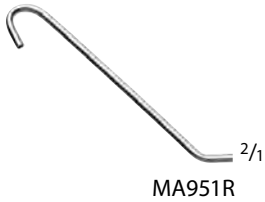
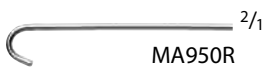

MORRISON Aspirating Cannula, Front Opening

Catalog Number	Tip	Tip Size (Gauge)	Shaft	Length (in.)
MA949R	SMOOTH, BLUNT	23	ANG 7 MM FROM TIP	1

MCINTYRE-BINKHORST Cannula, Front Opening, Hook Shape

Catalog Number	Tip	Tip Size (Gauge)	Shaft	Length (in.)
MA950R	SMOOTH, BLUNT	26	STR	3/4
MA951R	SMOOTH, BLUNT	26	RIGHT ANG	3/4
MA952R	SMOOTH, BLUNT	26	LEFT ANG	3/4

CHANG Nucleus Hydrodissector Cannula

Catalog Number	Tip	Tip Size (Gauge)	Shaft	Length (in.)
MA953R	FLAT, BEVELED OPENING	27	RIGHT ANG	1/2

ATKINSON Retrobulbar Needle

Catalog Number	Tip Size (Gauge)	Shaft	Length (in.)
MA954R	23	STR	1 3/8

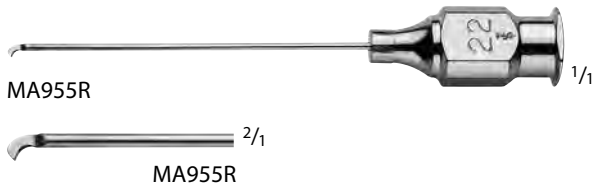

KELMAN Cystotome

Catalog Number	Tip Size (Gauge)	Shaft	Length (in.)
MA955R	22	STR	1 1/4

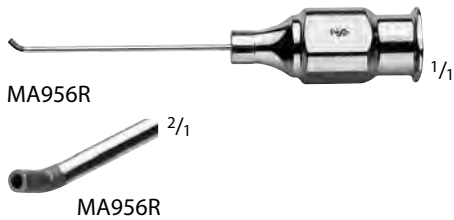

KRATZ Capsule Scrubber

Catalog Number	Tip	Tip Size (Gauge)	Shaft	Length (in.)
MA956R	ROUGHENED	23	ANG	3/4

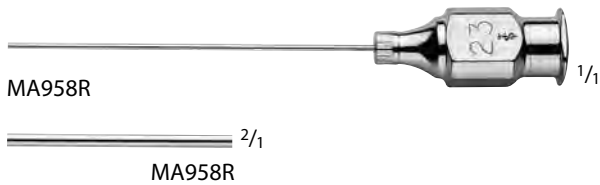

Backflush Infusion Cannula

Catalog Number	Tip Size (Gauge)	Shaft	Length (in.)
MA958R	23	STR	1 3/8

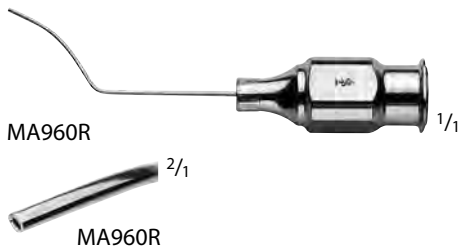

NICHAMIN Hydrodissection Cannula

Catalog Number	Tip Size (Gauge)	Shaft	Length (in.)
MA960R	25	ANG	1

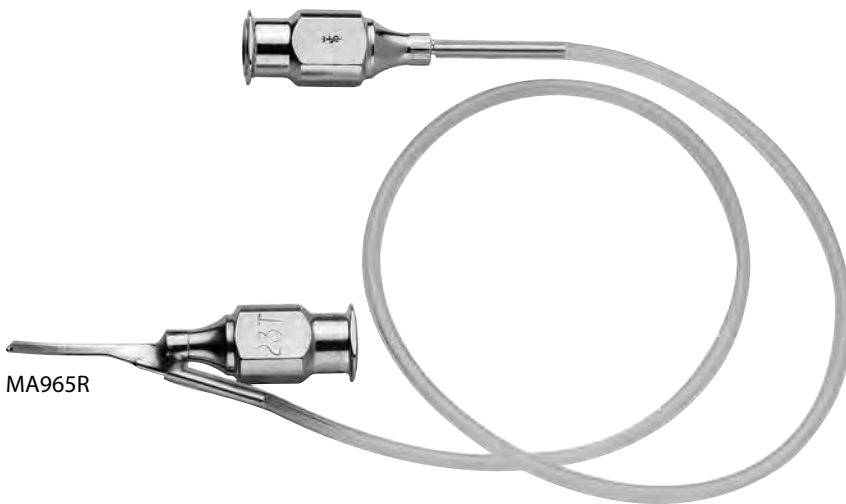
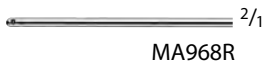

Air Injection Cannula

Catalog Number	Tip Size (mm)	Tip Size (Gauge)	Shaft	Length (in.)
MA640R	5	27	ANG	3/4
MA641R	5	30	ANG	3/4

WEST Lacrimal Cannula, Side Port

Catalog Number	Tip Size (mm)	Tip Size (Gauge)	Shaft	Length (in.)
MA968R	0.3	23	STR	1 1/4

SIMCOE Irrigating Aspirating Unit

Catalog Number	Tip Size (Gauge)	Description
MA965R	23	ASPIRATION THROUGH 0.3 MM TOP PORT, IRRIGATION THROUGH FRONT PORT, USES 225 MM TUBING



MA002R



MA001R



MB791R



OB793R

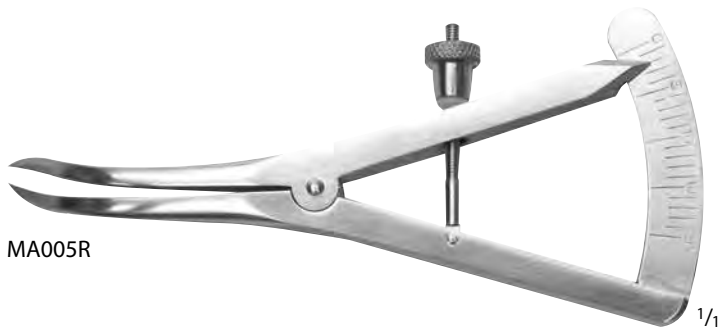

MA005R



MA888R



MA888R

BRAUNSTEIN Fixed Caliper, Double Ended

Catalog Number	Tip Size (mm)	Length (in.)
MA002R	3.0 / 3.5	2 3/4
MA001R	3.5 / 4.0	2 3/4

CASTROVIEJO Eye Caliper

Catalog Number	Tip	Description	Length (in.)
MB791R	STR	0 - 15 MM RANGE	3 1/8
OB793R	STR	0 - 40 MM RANGE	6 3/4
MA005R	CVD	0 - 20 MM RANGE	3 3/8

AKAHOSHI Combo Prechopper, Cross-Action

Catalog Number	Jaw	Jaw Length (mm)	Length (in.)
MA888R	STR	4.5	4 1/4

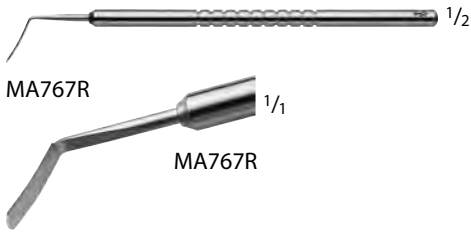

Corneal Dissector Knife

Catalog Number	Blade	Shaft	Length (in.)
MA767R	CVD	ANG	4 1/2

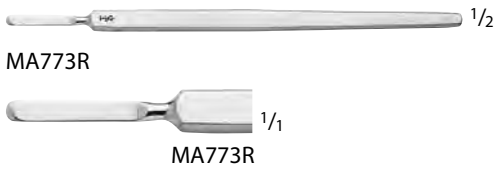

TOOKE Corneal Knife

Catalog Number	Blade	Blade Size (mm)	Length (in.)
MA773R	STR	3 x 18	4 3/4

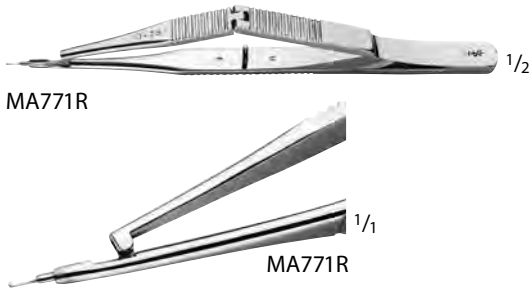

KELLY-DESCEMET'S Membrane Punch

Catalog Number	Diameter (mm)	Length (in.)
MA771R	1	5 1/8



CARTER Sphere Introducer

Catalog Number	Length (in.)
MA974R	5

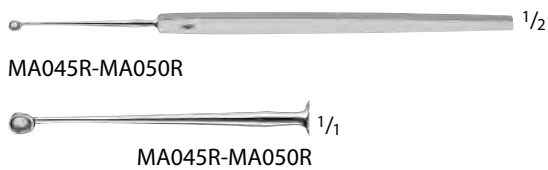

MEYERHOEFFER Chalazion Curette

Catalog Number	Tip Size (#)	Cup (mm)	Length (in.)
MA045R	0	1.5	5
MA046R	1	1.7	5
MA047R	2	2	5
MA049R	3	2.5	5
MA050R	4	3.5	5



Orthopedics/Spine

Scissors	880 - 885
Plaster/Nail/Wire Instruments	886 - 898
Meniscus Instruments	899
Forceps	900 - 916
Retractors	917 - 956
Rasps	957 - 959
Elevators and Bone Levers	960 - 973
Chisels/Gouges/Osteotomes	974 - 987
Mallets/Impactors/Bone Tamps	988 - 994
Drills/Burr/Reamers	995 - 996
Reamers and Trephines	997
Curettes	998 - 1013
Microdiscectomy Instruments	1014 - 1018
Dissectors and Probes	1019
Rongeurs	1020 - 1049
Kerrison Bone Punches	1050 - 1057
KAIRison Pneumatic Bone Punch	1058 - 1059
Bone Cutters	1060 - 1063
Rulers, Calipers and Gauges	1064 - 1065



BC881R-BC989R

1/2

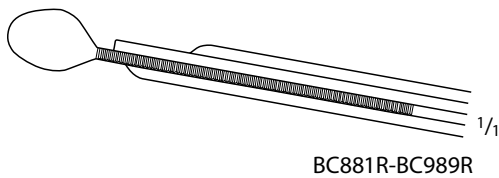

BC881R-BC989R

1/1



BC885R-BC979R

1/2

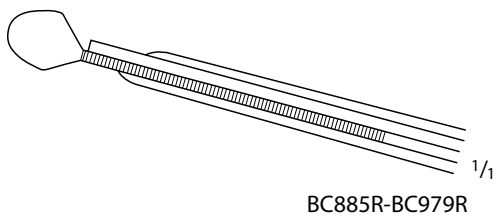

BC885R-BC979R

1/1

Universal Bandage Scissors

Catalog Number	Handle Color	Length (in.)
BC881R	BLACK	7
BC980R	RED	7
BC981R	BLUE	7
BC983R	YELLOW	7
BC985R	ORANGE	7
BC987R	PINK	7
BC988R	LIGHT GREEN	7
BC989R	VIOLET	7

LISTER Universal Bandage Scissors

Catalog Number	Handle Color	Length (in.)
BC885R	BLACK	5 3/4
BC970R	RED	5 3/4
BC971R	BLUE	5 3/4
BC973R	YELLOW	5 3/4
BC975R	ORANGE	5 3/4
BC977R	PINK	5 3/4
BC978R	LIGHT GREEN	5 3/4
BC979R	VIOLET	5 3/4

Let Us know if you could not find what you are looking for



LISTER Bandage Scissors, Serrated

Catalog Number	Length (in.)
MB146R	3 1/2
BC876R	6 1/4

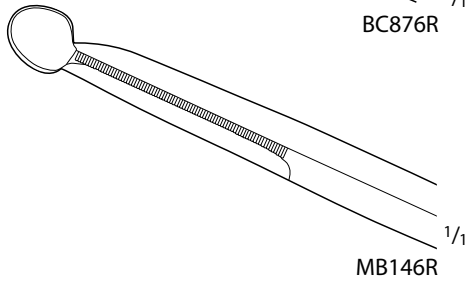
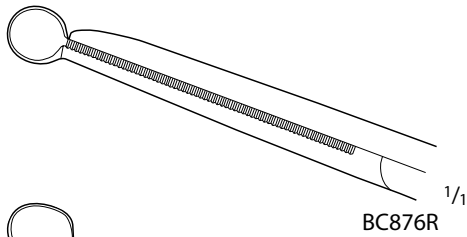



BC848R-BC863R

1/2

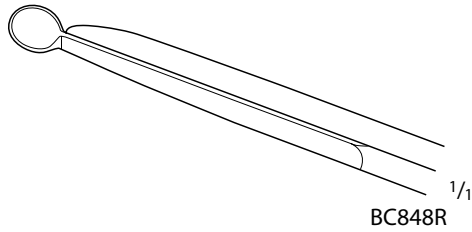

BC848R

1/1

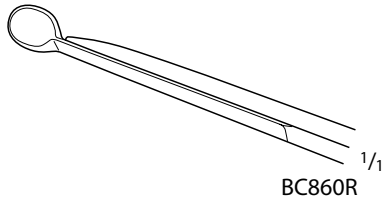

BC860R

1/1

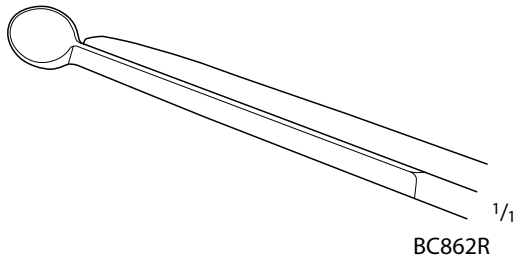

BC862R

1/1



MB223

1/2



MB223

1/1

LISTER Bandage Scissors

Catalog Number	Blade	Length (in.)
BC848R	LONG	6 1/8
BC849R	LONG	7
BC860R	STANDARD	4 1/2
BC861R	STANDARD	5 1/2
BC862R	STANDARD	7
BC863R	STANDARD	7 7/8

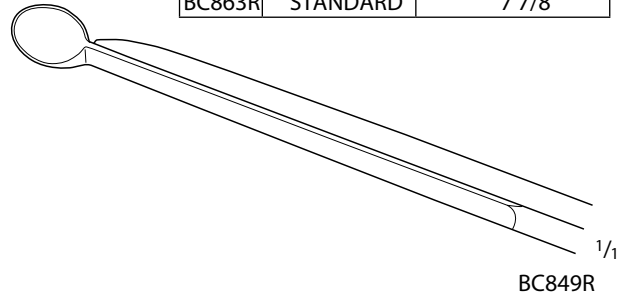

BC849R

1/1

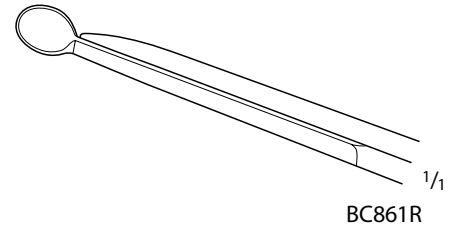

BC861R

1/1

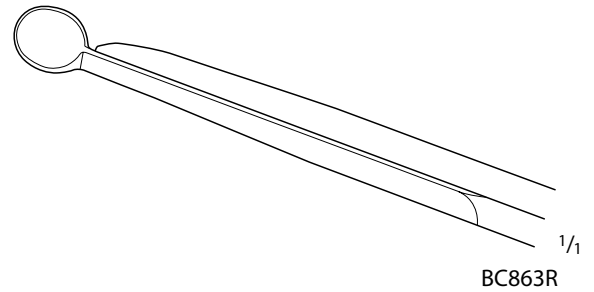

BC863R

1/1

LISTER Bandage Scissors
 W/ One Large Ring

Catalog Number	Length (in.)
MB223	8

Let Us know if you could not find what you are looking for

Plaster and Bandage Scissors

Catalog Number	Length (in.)
LX558R	9 1/4



LX558R

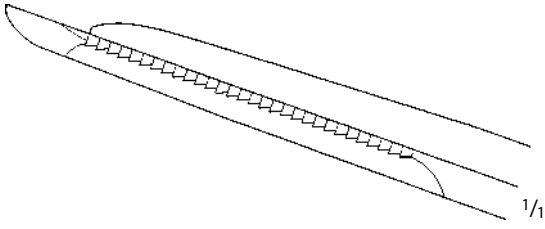

LX558R

Plaster Scissors

Catalog Number	Length (in.)
LX548R	6 1/4



LX548R

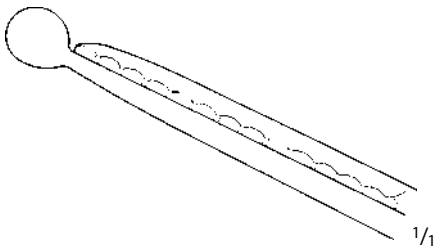

LX548R

BRUNS Plaster Scissors

Catalog Number	Length (in.)
LX556R	9 1/4

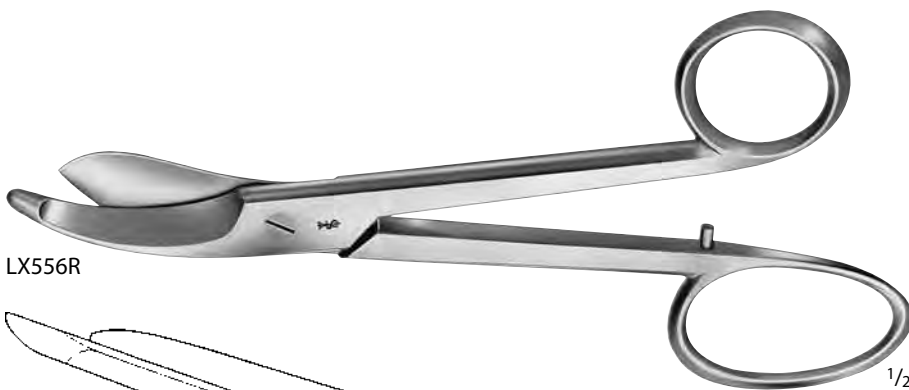

LX556R

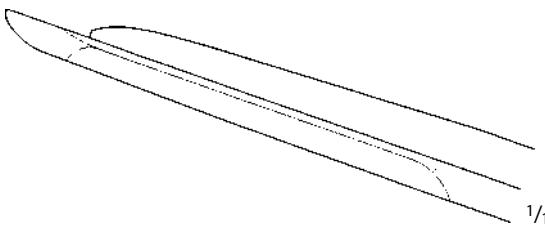

LX556R



BERGMANN Plaster Scissors

Catalog Number	Length (in.)
LX553R	9

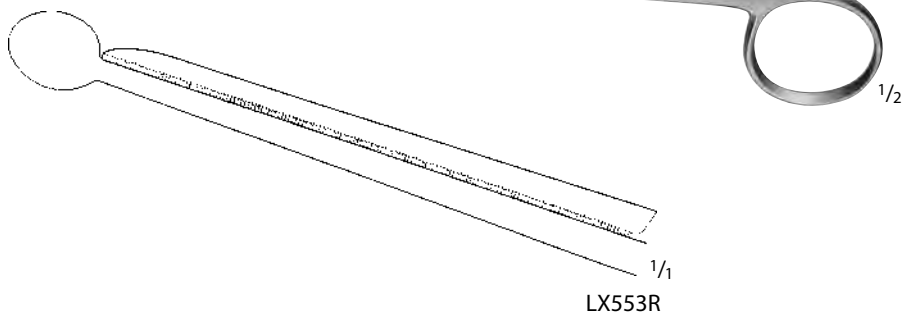

ESMARCH Plaster Scissors

Catalog Number	Length (in.)
LX550R	7 7/8
LX552R	9

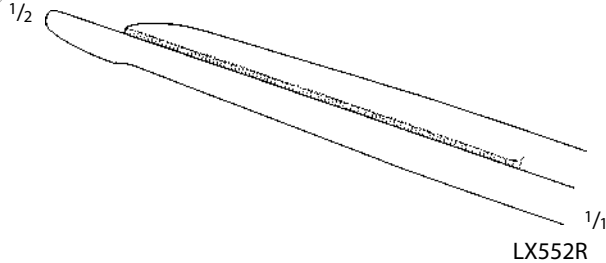
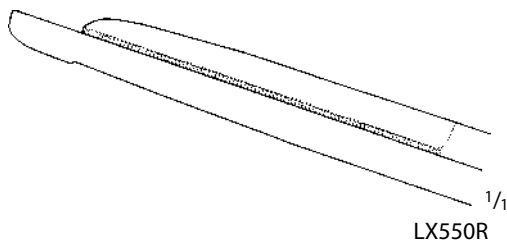

HERCULES Plaster Shears

Catalog Number	Length (in.)
MB106R	7 1/2



Plaster Scissors

Catalog Number	Length (in.)
BC888R	8

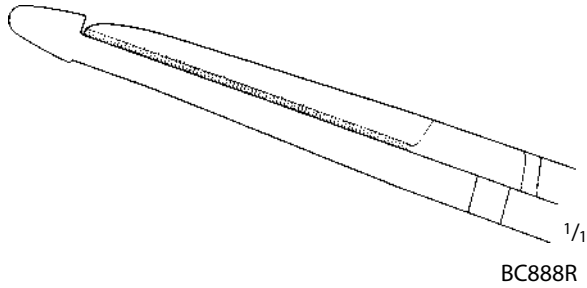

SEUTIN Plaster and Bandage Scissors

Catalog Number	Length (in.)
LX565R	9

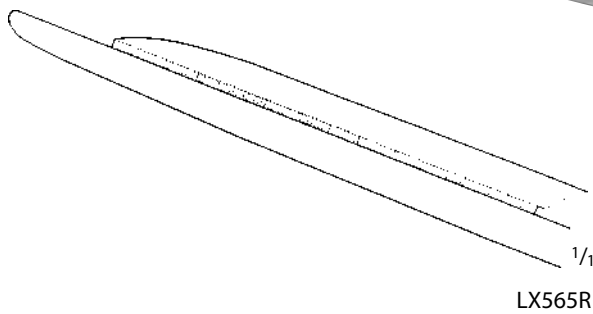

RESANO Cartilage Scissors

Catalog Number	Tip	Blade	Length (in.)
BC595R	B/B	ANG	9 3/4

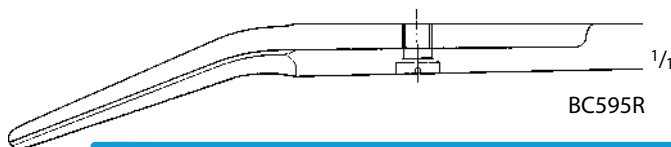
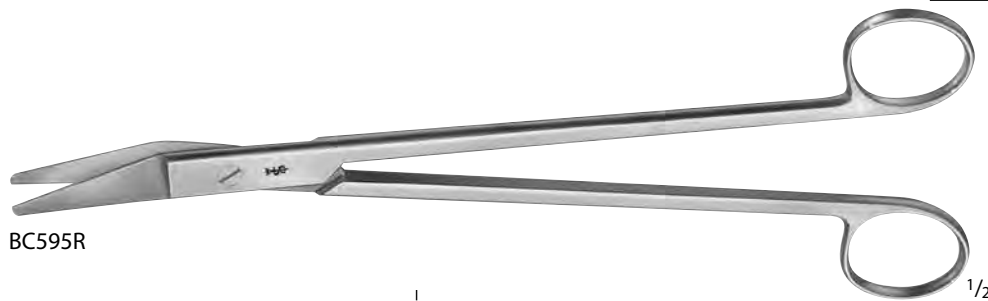



LX600R

HENNIG Plaster Spreader

Catalog Number	Length (in.)
LX600R	10 5/8



LX605R

Plaster Spreader

Catalog Number	Length (in.)
LX605R	9



LX618R-LX624R

WOLFF Plaster Breaker

Catalog Number	Length (in.)
LX618R	7
LX624R	9 1/2



HF213R

Nail Cutter

Catalog Number	Length (in.)
HF213R	5 1/4

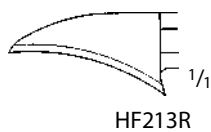

HF213R



BC521R

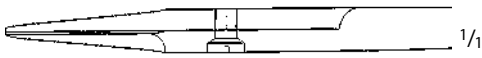

BC521R



HF021R



HF021R



MB370R



MB370R

SYSTRUNK Nail Splitting Scissors

Catalog Number	Tip	Blade	Length (in.)
BC521R	S/S	STR	5 1/8

Nail Scissors

Catalog Number	Tip	Blade	Length (in.)
HF021R	S/S	CVD	4 1/4

Needle Nose Pliers/Wire Cutters

Catalog Number	Length (in.)
MB370R	7 1/4

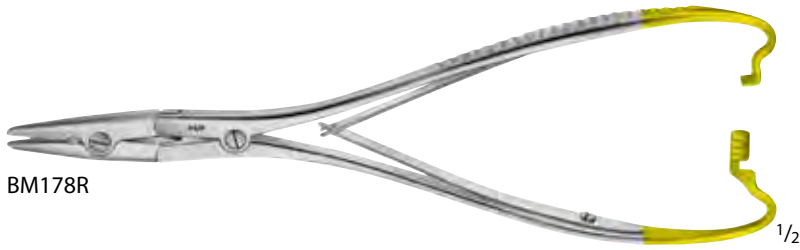

BM178R

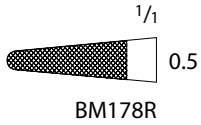

BM178R

DUROGRIP™ TC Needle Holder, Double Action

Catalog Number	Handle	Jaw	Length (in.)
BM178R	RATCHET	SERR	7 7/8



LX150R

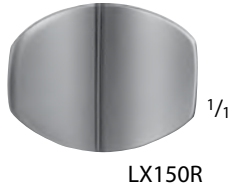

LX150R

Wire Cutter, W/ Specially Hardened Cutting Edges

Catalog Number	For Wire Size	Length (in.)
LX150R	SOFT, UP TO 2MM AND HARD, UP TO 1.5MM	5 3/4
LX152R	SOFT, UP TO 3.5MM AND HARD, UP TO 2.0MM	8 3/4
LX156R	SOFT, UP TO 3MM AND HARD, UP TO 2.2MM	9 1/4



LX152R



LX152R

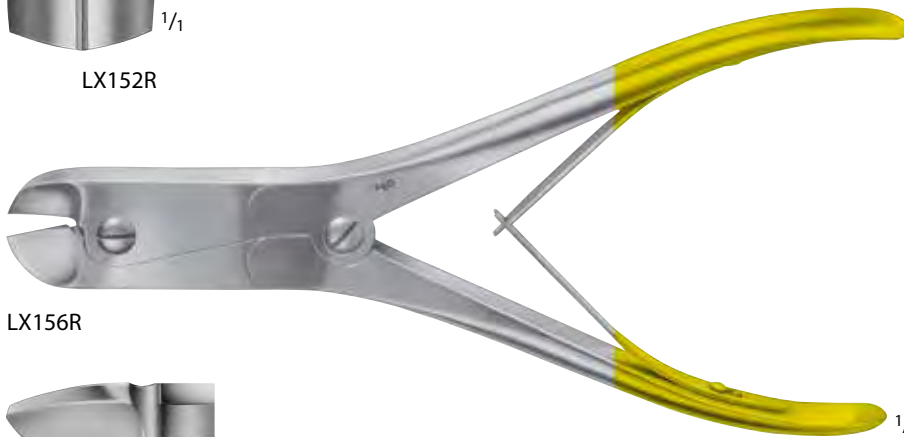

LX156R



LX156R



HARVEY Wire Cutter, W/ Specially Hardened Cutting Edges

Catalog Number	For Wire Size	Tip	Length (in.)
LX157R	SOFT, UP TO 3MM AND HARD, UP TO 2.2MM	ANG	9 1/4

LX157R

1/2



Wire Cutter, Front and Lateral, W/ Specially Hardened Cutting Edges

Catalog Number	Wire Size	Length (in.)
LX158R	SOFT, UP TO 2MM AND HARD, UP TO 1.5MM	7

LX158R

1/2



1/1

LX158R



LX159R

1/2



1/1

LX159R

REILL Cutter, F/ Wire Close To Bone, W/
 Specially Hardened Cutting Edges

Catalog Number	For Wire Size	Length (in.)
LX159R	SOFT, UP TO 2MM AND HARD, UP TO 1.5MM	6 7/8



LX163R

1/2



1/1

LX163R

Front Cutter, W/ Specially Hardened
 Cutting Edges

Catalog Number	For Wire Size	Length (in.)
LX163R	SOFT, UP TO 3.5MM AND HARD, UP TO 2.5MM	6 1/2



LX162R

TC Wire Cutter W/ Carbide Cutting
 Edges

Catalog Number	Length (in.)
LX162R	9 1/2

1/2



MG025R

TC Wire Cutter Double Action

Catalog Number	Packaging	Tip	Length (in.)
MG025R	2.5	ANG	8 3/4



MG025R

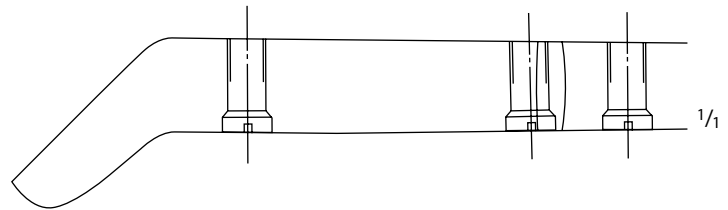

MG029R

TC Flush Wire Cutter

Catalog Number	Packaging	Tip	Length (in.)
MG029R	1.6	FRONT AND LATERAL	6 3/4

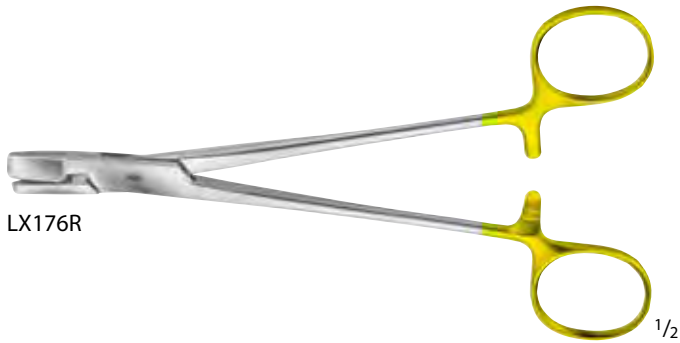

LX176R

1/2



1/1

LX176R

Wire Holding Forceps W/Hard Metal Inserts

Catalog Number	Length (in.)
LX176R	6 3/4



LX179R

1/2

Wire Grasping Forceps W/Hard Metal Inserts

Catalog Number	Tip	Length (in.)
LX179R	FLAT	7 1/2

HERCULES Pin Cutter

Catalog Number	Packaging	Description	Length (in.)
MG088R	3	TUNGSTEN CARBIDE	8 3/4



MG088R

1/2

Pin Cutter, End-Cutting

Catalog Number	Packaging	Length (in.)
MG089R	4.7	14 3/4
MG090R	6.3	22 1/2



MG089R

1/3

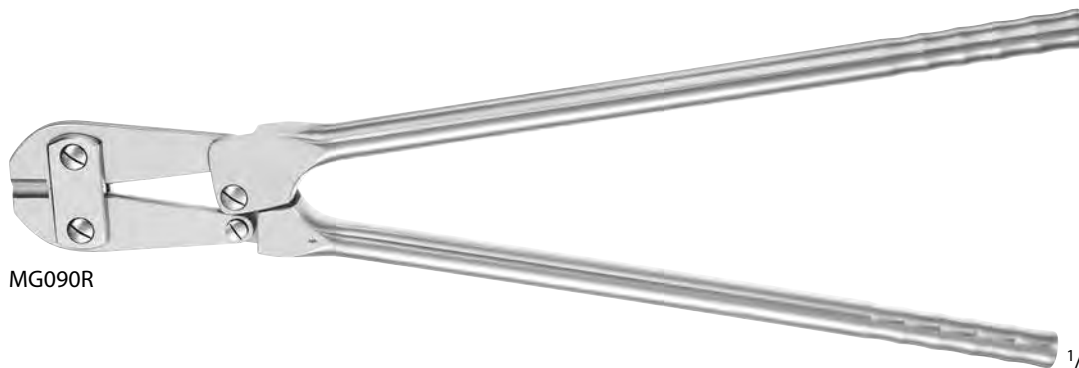

MG090R

1/4

Bolt Cutter

Catalog Number	Item	Length (in.)
LX164R	F/KIRSCHNER WIRES, TIBIA HEAD SCREWS, BOLTS, PINS, UP TO 6MM	18 1/2



LX164R

Bolt Cutter

Catalog Number	Item	Length (in.)
LX165R	F/KIRSCHNER WIRES, TIBIA HEAD SCREWS, BOLTS, PINS, UP TO 6MM	12 1/2

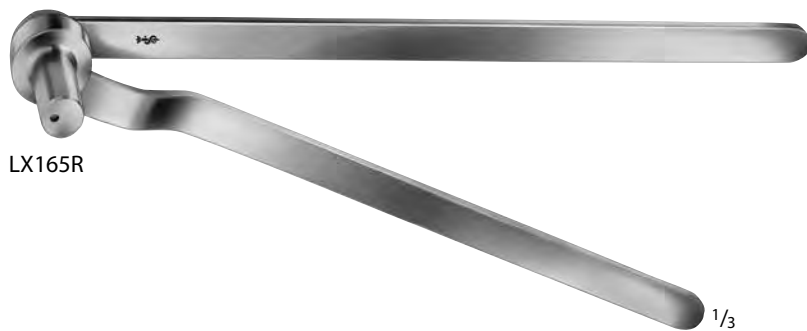

LX165R



LX165R

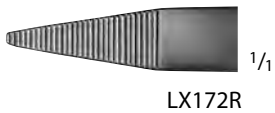

Wire Holding Pliers

Catalog Number	Tip	Length (in.)
LX170R	SERR	6 3/4
LX171R	CROSS-GROOVES	6 3/4

Wire Holding Forceps

Catalog Number	Tip	Length (in.)
LX172R	SERR	7 1/2

Wire Holding Pliers

Catalog Number	Tip	Tip Size (mm)	Length (in.)
MG026R	LOCKING	7	7



MG028R

Wire Holding Needle-Nose Pliers

Catalog Number	Tip	Tip Size (mm)	Length (in.)
MG028R	LOCKING, NEEDLE-NOSE	5	9 1/2



1/1

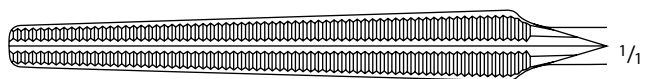

1/1

MG028R



LX174R

Vise Grip Pliers

Catalog Number	Tip	Length (in.)
LX174R	FLAT NOSE	7 7/8



1/1

LX174R



LX175S

Bending Iron

Catalog Number	FOR BORING WIRE SIZE	Length (in.)
LX175S	UP TO 2.7MM	4 3/4



LX177R-LX178R

Wire Extraction Pliers

Catalog Number	Length (in.)
LX177R	5 1/8
LX178R	7



1/1



1/1



1/1

LX177R



1/1

LX178R



LX181R-LX185R

Wire Extraction Pliers

Catalog Number	Tip	Length (in.)
LX181R	RND	7
LX182R	RND, SHORT JAW	7
LX183R	FLAT	7
LX185R	PARALLEL	5 3/4



1/1



1/1

LX181R



1/1

LX182R



1/1

LX183R



1/1

LX185R



MB576R

1/2

Utility Pliers

Catalog Number	Length (in.)
MB576R	7 3/4



LX189R

1/2

Flat Nosed Pliers

Catalog Number	Tip	Length (in.)
LX189R	PARALLEL	7 1/4

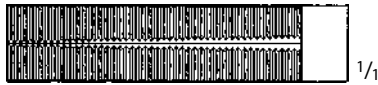

1/1

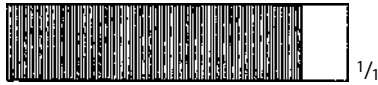

1/1

LX189R

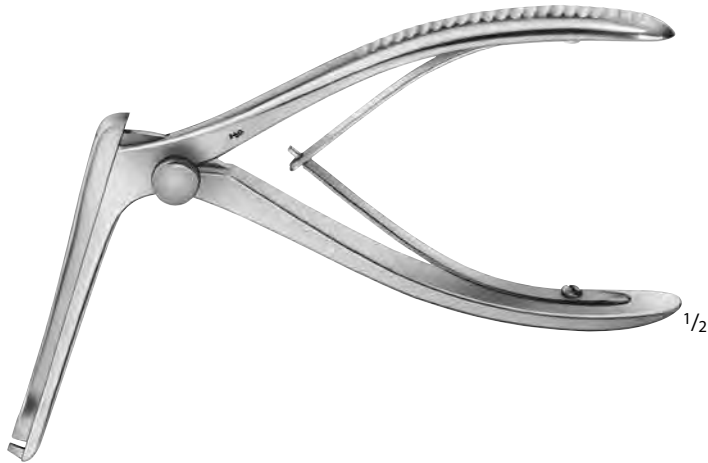

LX190R

1/2

Wire Bending Pliers

Catalog Number	For Wire Size
LX190R	UP TO 1.8MM

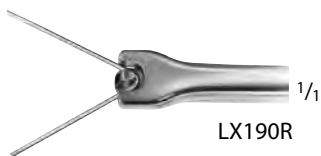

LX190R

1/1

SMILLIE Meniscotome

Catalog Number	Jaw	Length (in.)
FO857R	STRAIGHT	6 3/4
FO855R	LEFT	6 3/4
FO856R	RIGHT	6 3/4

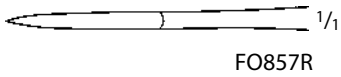

BIRCHER Cartilage Forceps

Catalog Number	Jaw	Length (in.)
FO800R	STR	7 7/8
FO801R	CVD	7 7/8



FO800R

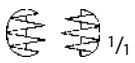

FO800R



FO801R

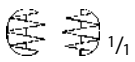

FO801R

WELLER Cartilage Forceps

Catalog Number	Jaw	Length (in.)
FO807R	CVD	7 7/8

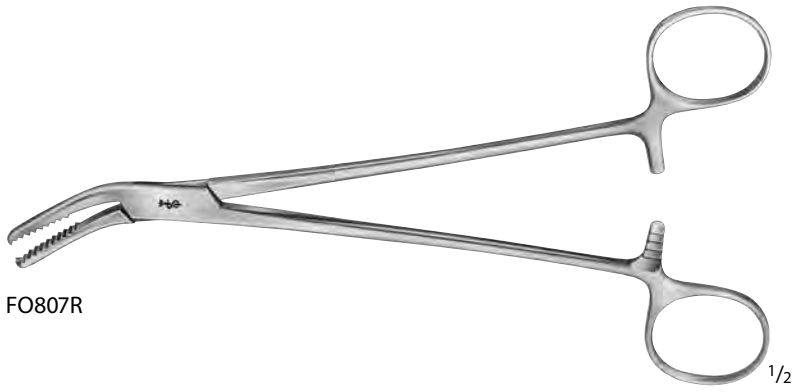

FO807R

1/2



1/1

FO807R

BIRCHER-GANSKE Cartilage Forceps

Catalog Number	Jaw	Length (in.)
FO808R	SLIGHT CVD	7 7/8

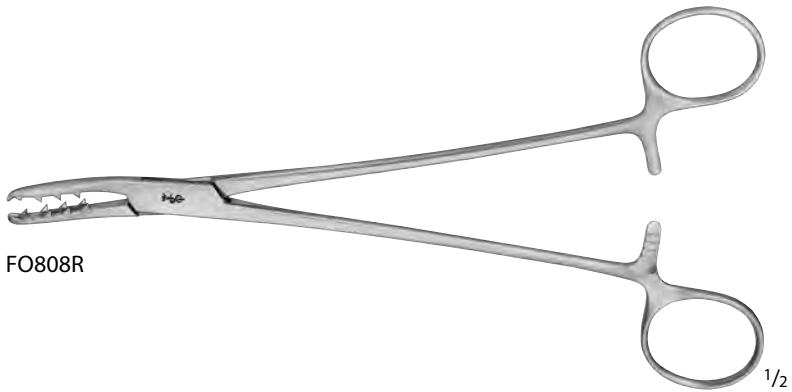

FO808R

1/2



1/1

FO808R

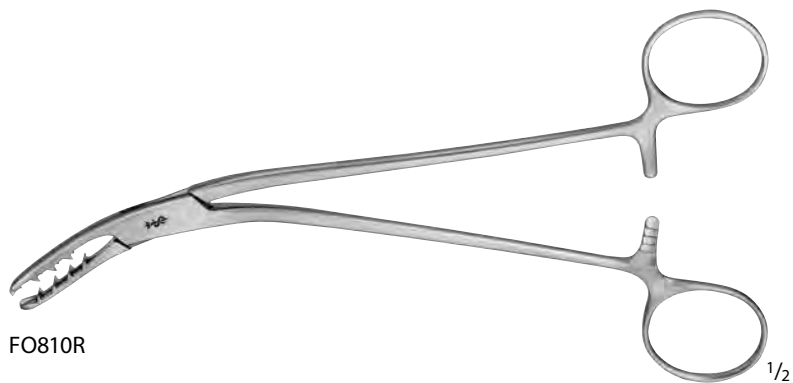

FO810R



FO810R

BIRCHER-GANSKE Cartilage Forceps
 (continued)

Catalog Number	Jaw	Length (in.)
FO810R	CVD	7 7/8

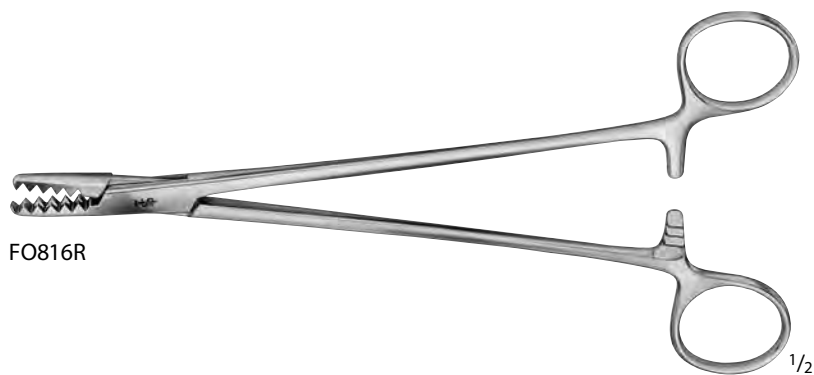

FO816R



FO816R

MARTIN Cartilage Forceps

Catalog Number	Jaw	Length (in.)
FO816R	STR	8

MEYER Reposition Forceps, F/ Wires

Catalog Number	For Wire Size	Length (in.)
FO106R	UP TO 1MM	6 3/4
FO108R	UP TO 2MM	8

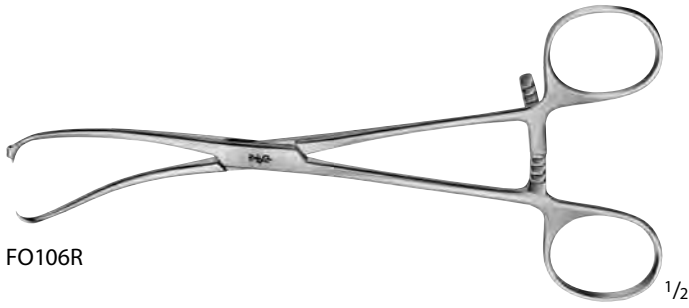

FO106R

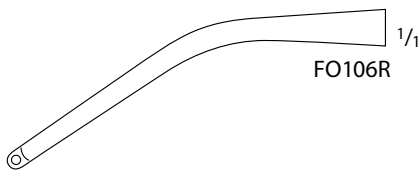

FO106R



FO108R

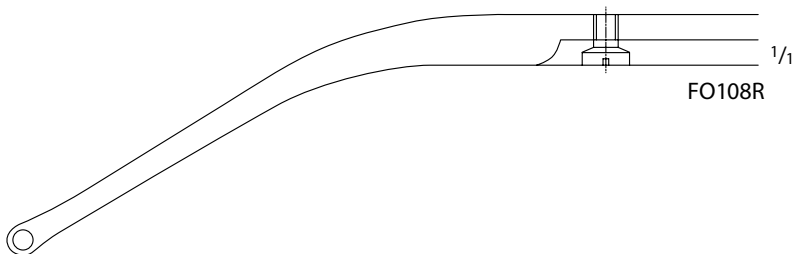

FO108R

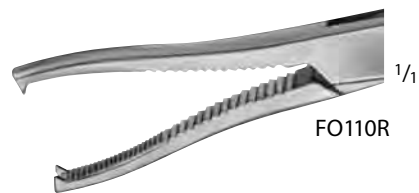

DINGMANN Bone Holding Forceps

Catalog Number	Teeth	Length (in.)
FO110R	2 x 2	7 1/4

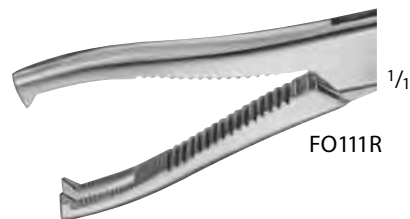

DINGMANN Bone Holding Forceps

Catalog Number	Teeth	Shaft	Length (in.)
FO111R	2 x 2	CVD	7 1/4

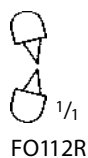

Bone Holding Forceps

Catalog Number	Length (in.)
FO112R	8 1/4

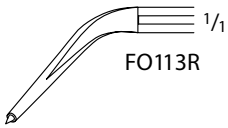

Finger Reposition Forceps, Stepped Tips

Catalog Number	Length (in.)
FO113R	3 3/4



Finger Reposition Forceps, F/ Small Fragments

Catalog Number	Length (in.)
FO115R	5 1/4



REILL Finger Reposition Forceps

Catalog Number	Length (in.)
FO116R	6 3/4



FO117R

1/2



FO117R

1/1

Forceps for Maxillary Reposition

Catalog Number	Length (in.)
FO117R	5 1/4

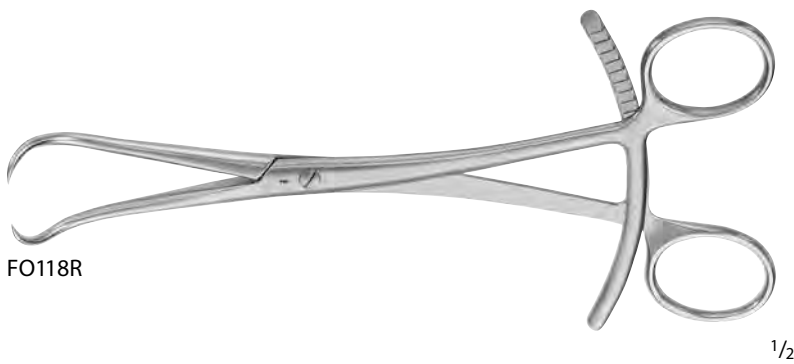

FO118R

1/2

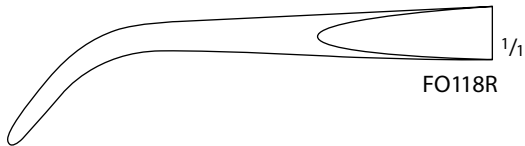

FO118R

1/1

Bone Reposition Forceps, Double Ratchet

Catalog Number	Length (in.)
FO118R	8



FO120R

1/2

1/1
 \sum 5 mm
 FO120R

Bone Holding Forceps

Catalog Number	Length (in.)
FO120R	7 7/8

Bone Reduction Forceps

Catalog Number	Length (in.)
FO123R	5 1/2



FO123R



FO123R

Bone Reduction Forceps, W/ Screw Lock and Thread Fixation

Catalog Number	Length (in.)
FO124R	6 3/4
FO125R	9 1/4



FO124R



FO125R



FO127R

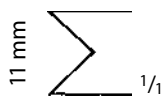

FO127R

LANGENBECK Bone Holding Forceps

Catalog Number	Tip Size (mm)	Length (in.)
FO127R	11	8



FO130R

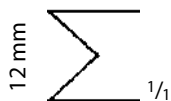

FO130R

FERGUSSON Bone Holding Forceps

Catalog Number	Tip Size (mm)	Length (in.)
FO130R	12	8



FO135R



FO135R

SEMB Rib/Bone Holding Forceps

Catalog Number	Tip Size (mm)	Item	Length (in.)
FO135R	8	W/O RATCHET	7 1/2
FO136R	8	W/ RATCHET	7 1/2



FO136R



FO136R



FARABEU Bone Holding Forceps

Catalog Number	Tip Size (mm)	Length (in.)
FO140R	9	9
FO141R	11	10

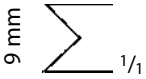
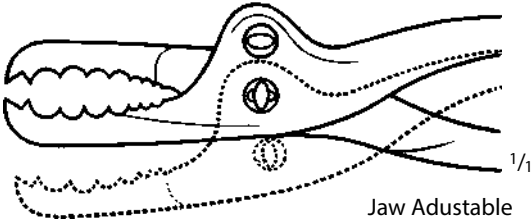

FO140R

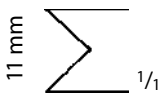

FO141R

FARABEU-LAMBOTTE Forceps,
 W/ Ratchet

Catalog Number	Tip Size (mm)	Length (in.)
FO143R	11	10

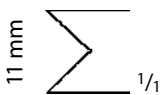

FO143R



FO148R

KERN Mini Bone Holding Forceps,
 W/ Ratchet

Catalog Number	Tip Size (mm)	Length (in.)
FO148R	7.5	6 1/8

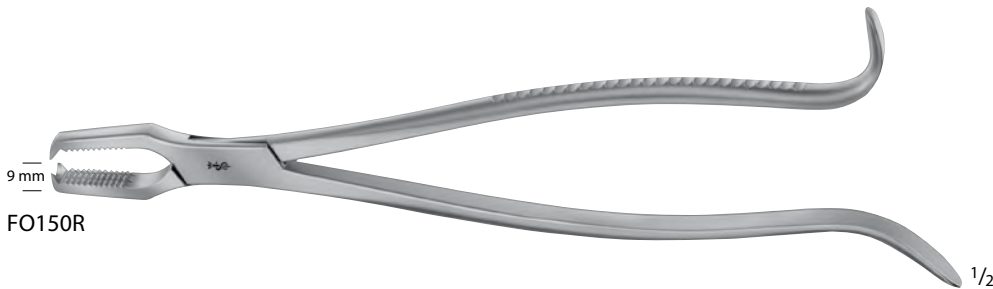

FO150R

KERN-LANE Bone Holding Forceps

Catalog Number	Tip Size (mm)	Length (in.)
FO150R	9	9 1/2



FO158R

KERN-LANE Bone Holding
 Forceps, W/ Ratchet

Catalog Number	Tip Size (mm)	Length (in.)
FO158R	9	9 1/2

LANE Bone Holding Forceps

Catalog Number	Tip Size (mm)	Description	Length (in.)
FO151R	9	W/O RATCHET	13
FO159R	13	W/ RATCHET	12 1/2

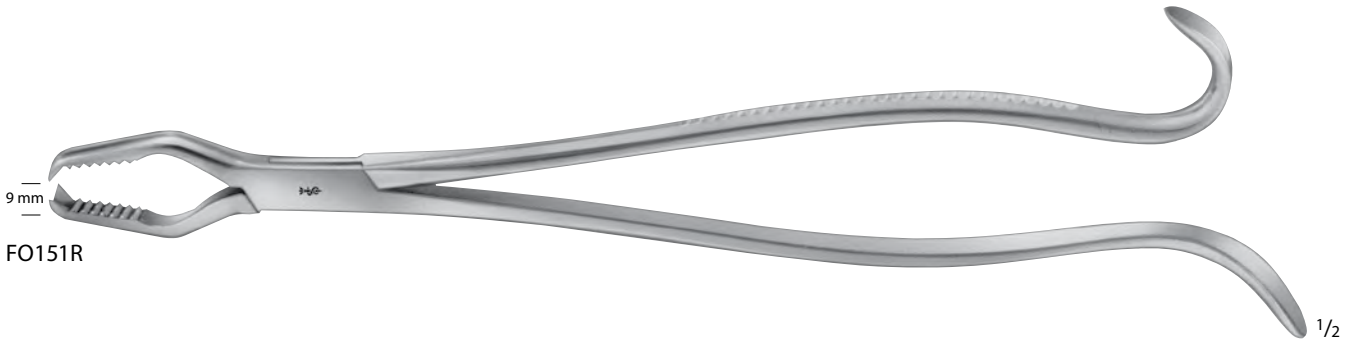

Let Us know if you could not find what you are looking for



FO153R

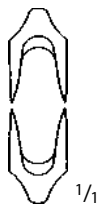

FO153R

Patella Forceps W/ Screw Lock

Catalog Number	Length (in.)
FO153R	7 1/4



FO160R-FO162R

LAMBOTTE Bone Holding Forceps,
 W/ Movable Jaw and Ratchet

Catalog Number	Tip Size (mm)	Length (in.)
FO160R	10	8 3/4
FO161R	13	10 1/4
FO162R	16	13



FO160R



FO161R

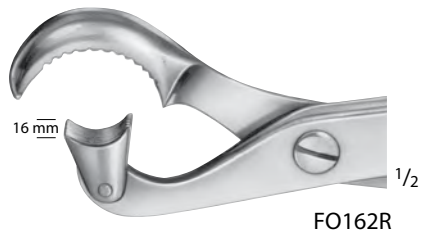

FO162R



FO169R-FO173R

Self-Centering Forceps, W/ Screw Lock and Thread Fixation

Catalog Number	Tip Size (mm)	Length (in.)
FO169R	3/3	5 3/4
FO170R	7 / 2.5	7 1/2
FO171R	10.5 / 3.5	9 1/2
FO172R	11 / 3.5	10 1/4
FO173R	11.5 / 4.5	10 3/4



FO169R

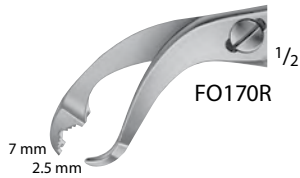

FO170R

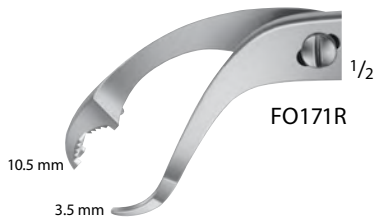

FO171R

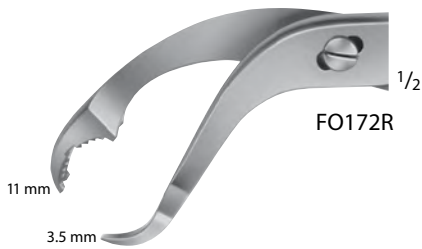

FO172R

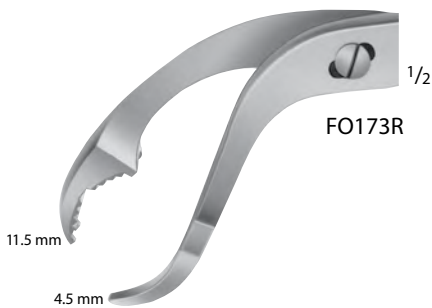

FO173R

VERBRUGGE Bone Forceps

Catalog Number	Tip Size (mm)	Length (in.)
FO180R	5	6 7/8
FO181R	10 / 4.0	9 3/4
FO182R	11 / 4.5	10 1/2
FO183R	12 / 4.5	10 5/8



FO180R



FO180R



FO181R-FO183R



FO181R

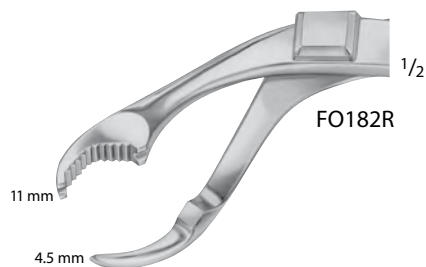

FO182R



FO183R



FO190R-FO191R

LOWMAN Bone Clamp

Catalog Number	Length (in.)
FO190R	6 7/8
FO191R	8



FO192R

LOWMAN-GERSTER Bone Clamp

Catalog Number	Length (in.)
FO192R	8 1/4



FO193R

LOWMAN-HOGLUND Bone Clamp

Catalog Number	Length (in.)
FO193R	6 7/8

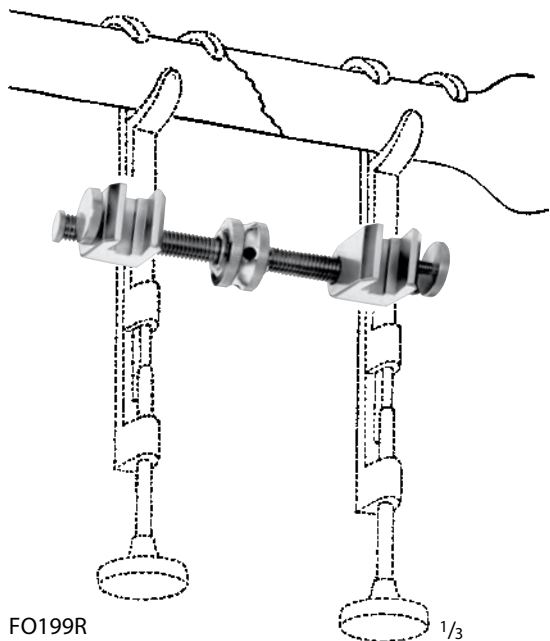

GERSTER Traction Bar
 F/FO190R-FO193R

Catalog Number
FO199R



LEWIN Bone Clamp

Catalog Number	Tip	Length (in.)
MD455	SERR	7

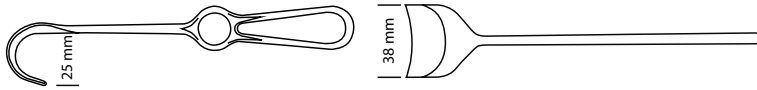

Dimensions for blade size of retractors
 1st number = depth Example: 25 x 38 mm
 2nd number = width



Knee Retractor

Catalog Number	Blade Size (mm)	Length (in.)
BT419R	39 x 9	8 7/8

BT419R

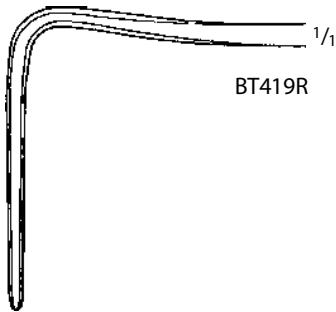

BT419R



BLOUNT Knee Retractor

Catalog Number	Blade Size (mm)	Length (in.)
BT420R	40 x 4	6 7/8

BT420R

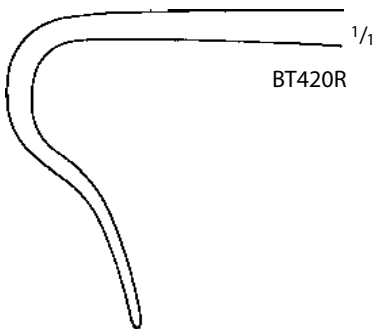

BT420R



BT430R

Knee Retractor

Catalog Number	Blade Size (mm)	Length (in.)
BT430R	56 x 10	6 3/4

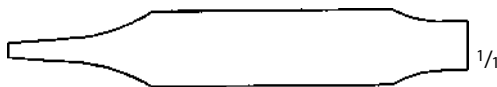
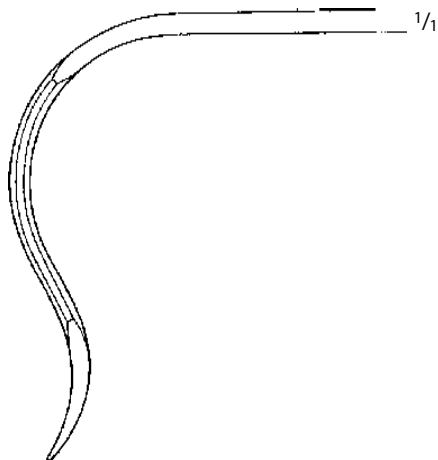

BT430R



MB976R

DOANE "Z" Knee Retractor

Catalog Number	Blade Size (mm)	Size
MB976R	55 x 75	MEDIUM
MB977R	66 x 80	LARGE



MB977R

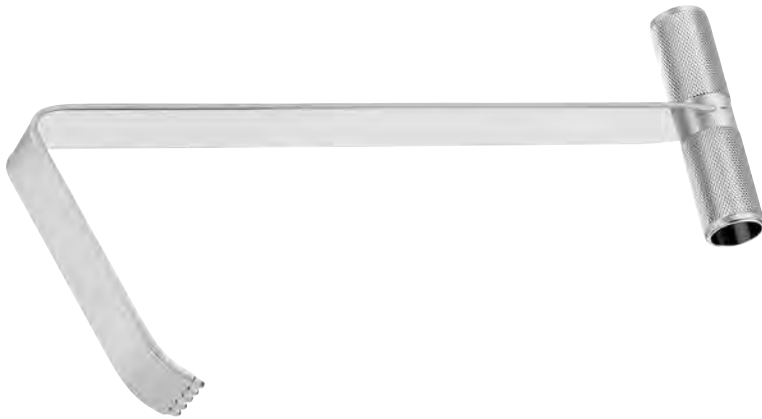

MD512R-MD514R

T-Handle Retractor

Catalog Number	Blade Size (mm)	Length (in.)
MD512R	120 x 32	7
MD513R	120 x 32	11
MD514R	120 x 32	13



BT503R-BT505R

HIBBS Retractor

Catalog Number	Blade Size (mm)	Length (in.)
BT503R	25 x 75	9 1/8
BT504R	20 x 50	9 1/8
BT505R	13 x 25	9 1/8



BT503R



BT504R



BT505R

TAYLOR Spinal Retractor

Catalog Number	Blade Size (mm)	Length (in.)
BT501R	30 x 70	7 1/4
BT502R	30 x 100	7 7/8



BT501R-BT502R



1/1

BT501R



1/1

BT502R



BT421R-BT425R

SMILLIE Retractor

Catalog Number	Blade Size (mm)	Length (in.)
BT421R	32 x 19	5 1/2
BT422R	48 x 19	5 1/2
BT423R	57 x 19	5 1/2
BT424R	52 x 13	5 1/2
BT425R	12 x 13	5 1/2

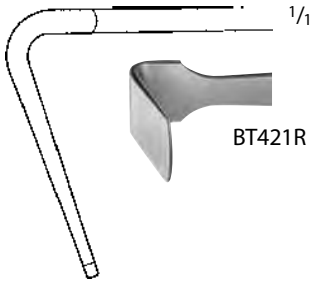

BT421R

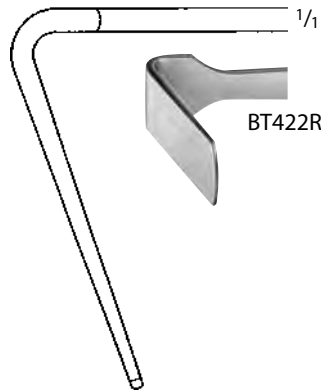

BT422R

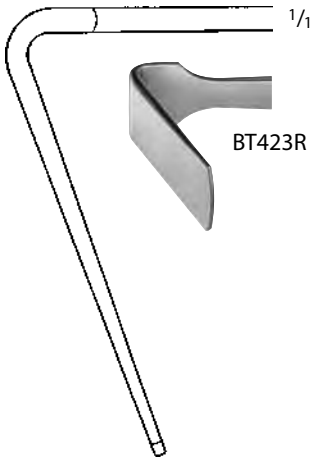

BT423R

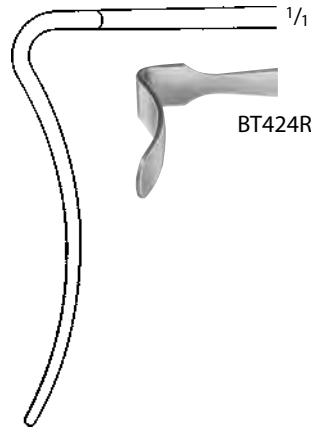

BT424R

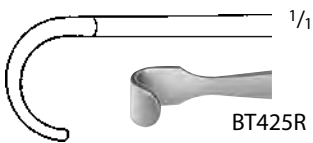

BT425R

MEYERDING Retractor

Catalog Number	Blade Size (mm)	Length (in.)
BT485R	52 x 16	9
BT486R	76 x 25	9
BT487R	89 x 50	10

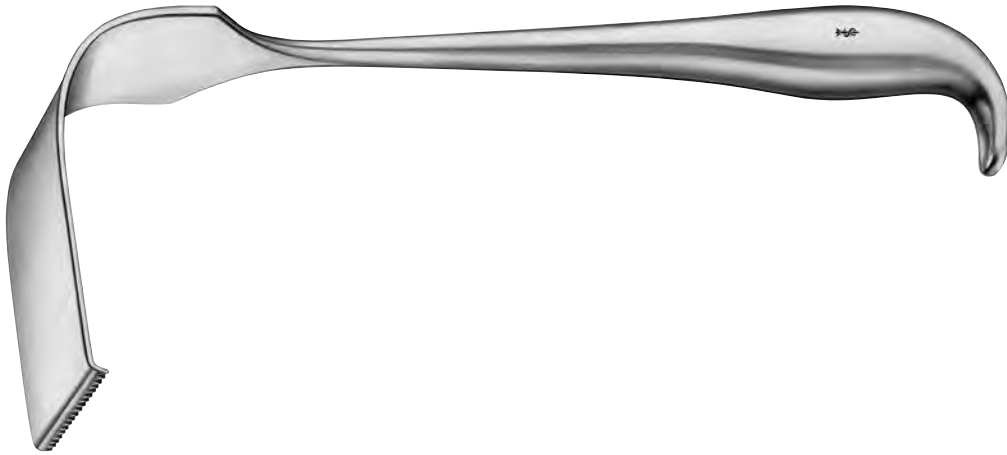

BT485R-BT487R

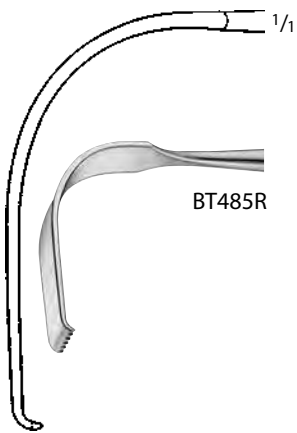

BT485R

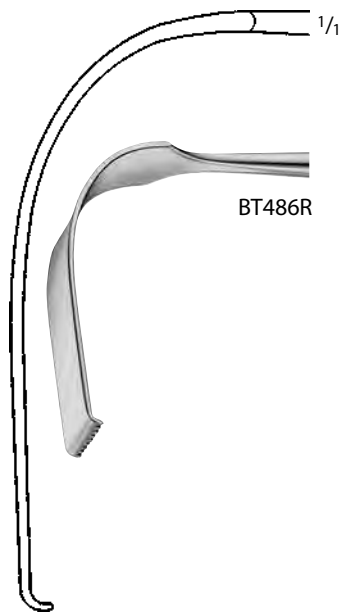

BT486R

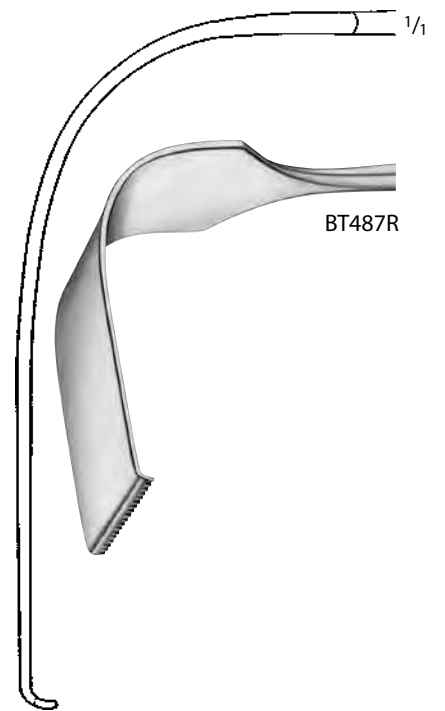

BT487R

AUFRANC Cobra Retractor

Catalog Number	Tip	Length (in.)
MB448R	SMOOTH, POINTED	10
MB514R	SMOOTH, BLUNT	10



1/2

MB448R-MB514R



1/1

1/1

MB448R-MB514R

AUFRANC Cobra Retractor

Catalog Number	Tip	Length (in.)
MB379R	SERR, BLUNT	10



MB379R

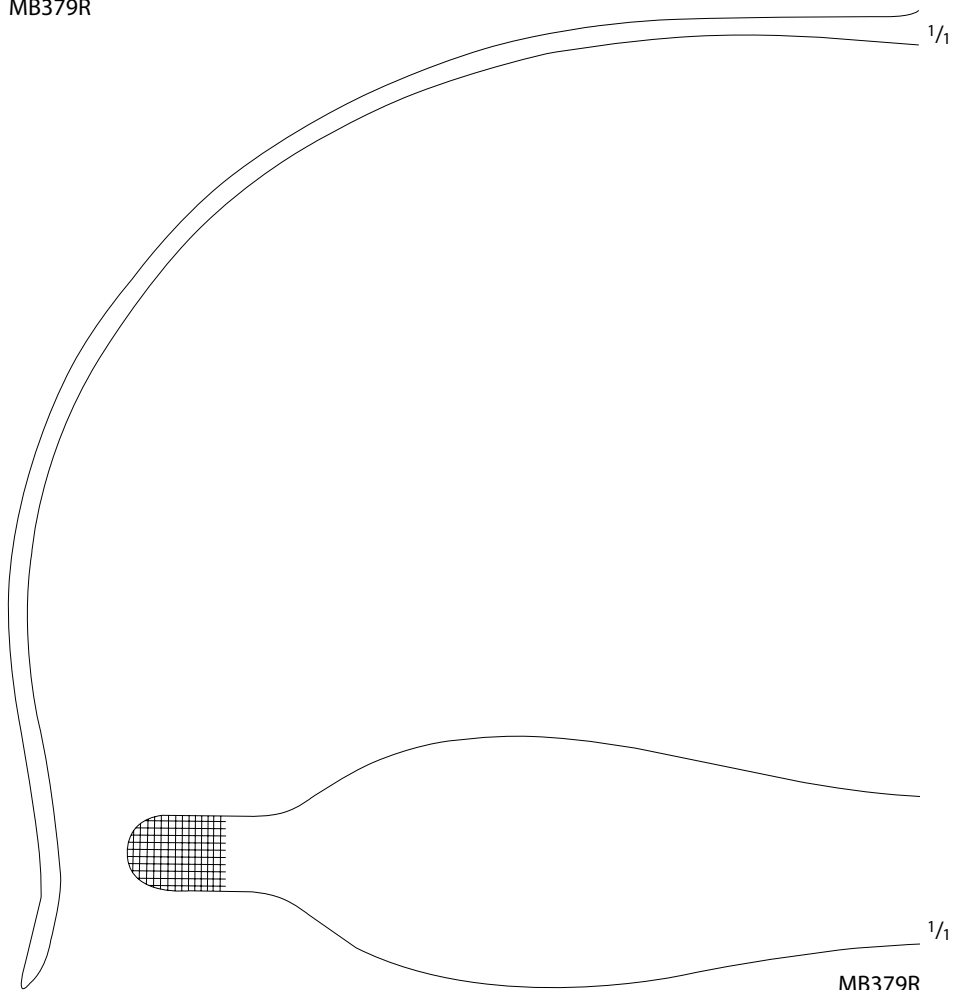

MB379R



MF058R-MF060R

CLOWARD Style Cervical Retractor
 W/ Lip

Catalog Number	Width (mm)	Length (in.)
MF058R	18	7
MF059R	20	7
MF060R	23	7



MN073R-MN075R

CLOWARD Style Cervical Retractor
 W/O Lip

Catalog Number	Width (mm)	Length (in.)
MN073R	18	7
MN074R	20	7
MN075R	23	7

HAYES Bone Retractor

Catalog Number	Blade Size (mm)	Length (in.)
FK110R	5.5	6 1/8
FK111R	2.8	5 1/2
FK113R	4.5	6
FK114R	7	6

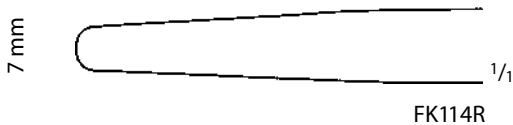
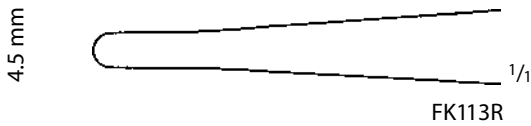
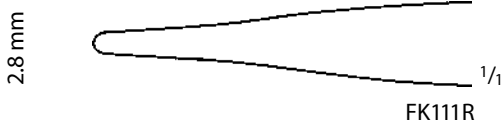
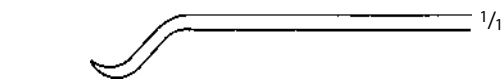
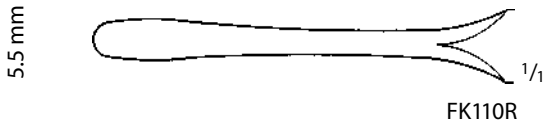

BUCK-GRAMCKO Bone Retractor

Catalog Number	Blade Size (mm)	Length (in.)
FK116R	2/7.5	6

HOHMANN Bone Retractor

Catalog Number	Blade Size (mm)	Length (in.)
FK117R	2/6	6 1/4
FK118R	2/8	6 1/4
MB449R	2/15	6

Baby HOHMANN Retractor

Catalog Number	Blade Size (mm)	Length (in.)
FK119R	2/15	5



FK116R

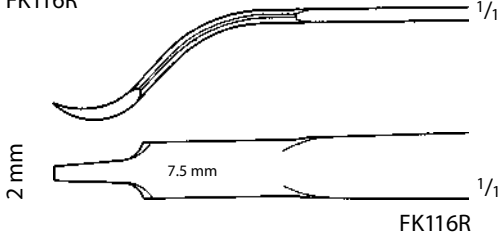

FK117R

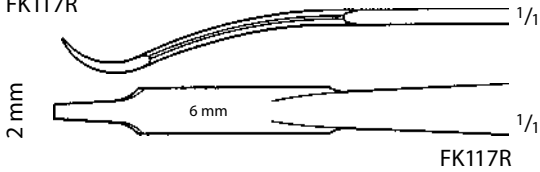

FK118R

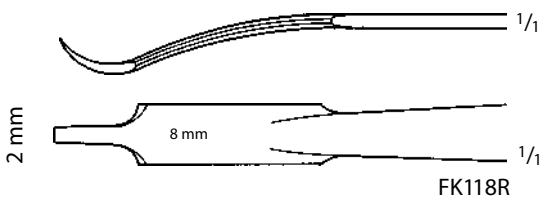

MB449R



FK119R

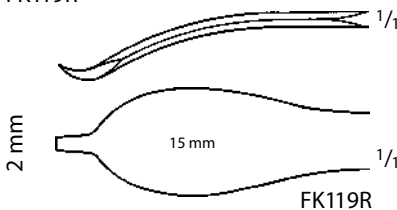



FK170R

HOHMANN Bone Retractor

Catalog Number	Blade Size (mm)	Length (in.)
FK170R	9	8 3/4
FK166R	17	9 1/2

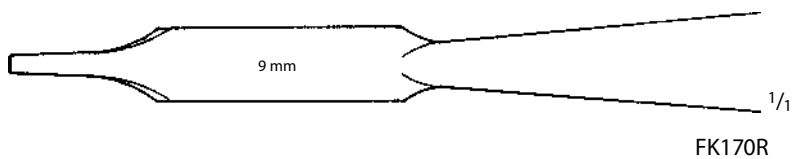
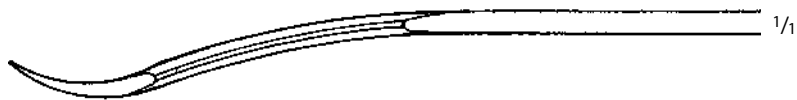

FK170R



FK166R

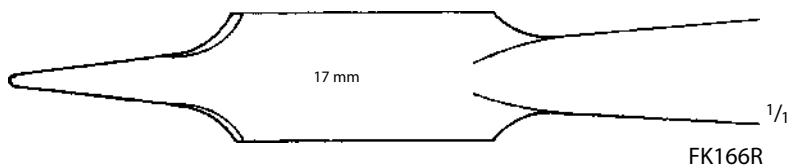

FK166R

HOHMANN Bone Retractor (continued)

Catalog Number	Blade Size (mm)	Length (in.)
FK171R	18	9 1/2
FK176R	25	10 5/8



FK171R

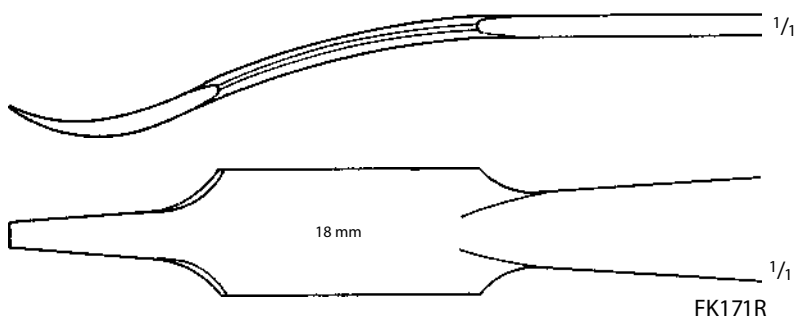

FK176R

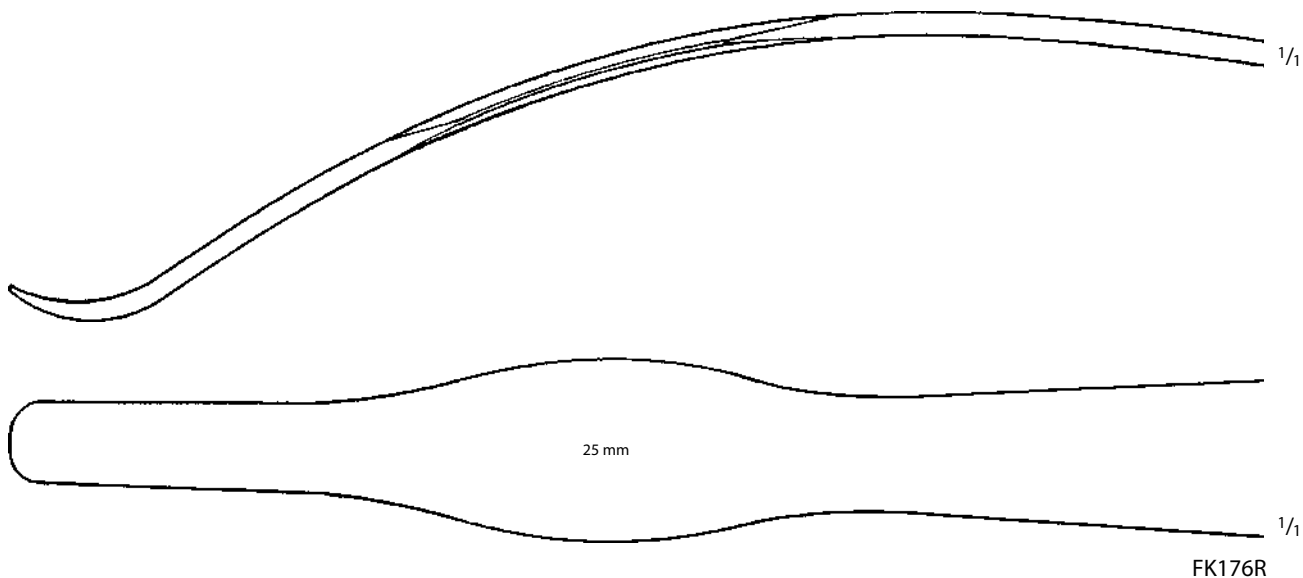

HOHMANN Bone Retractor (continued)

Catalog Number	Blade Size (mm)	Length (in.)
FK172R	24	10 1/4
FK173R	34	11 1/4



FK172R-FK173R

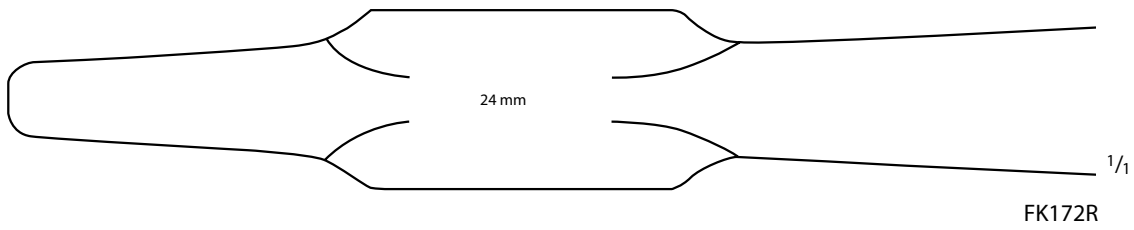
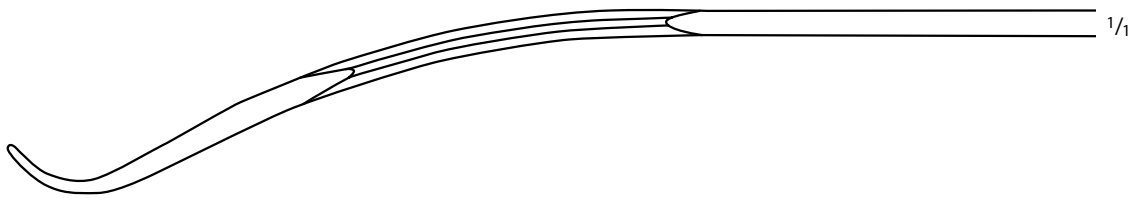

FK172R

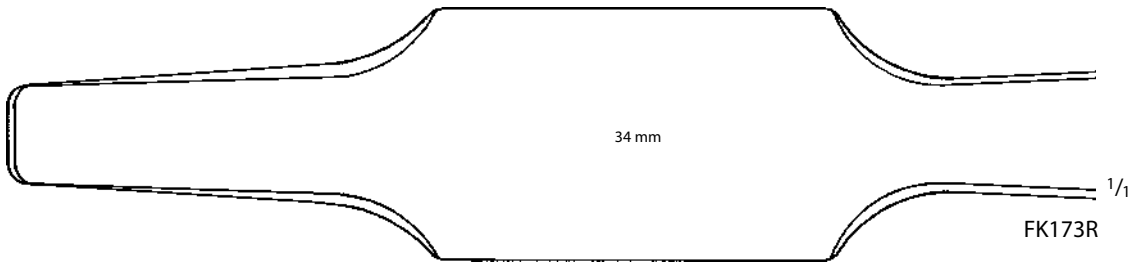
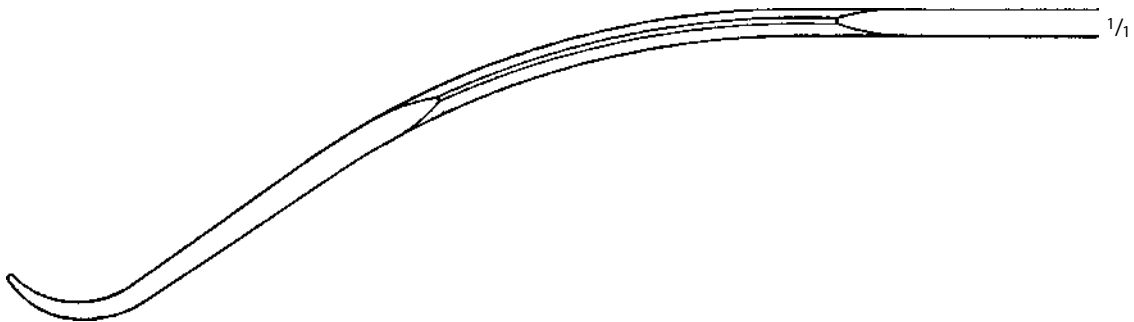

FK173R

LANGE-HOHMANN Bone Retractor

Catalog Number	Blade Size (mm)	Length (in.)
FK160R	24	9 3/4



FK160R

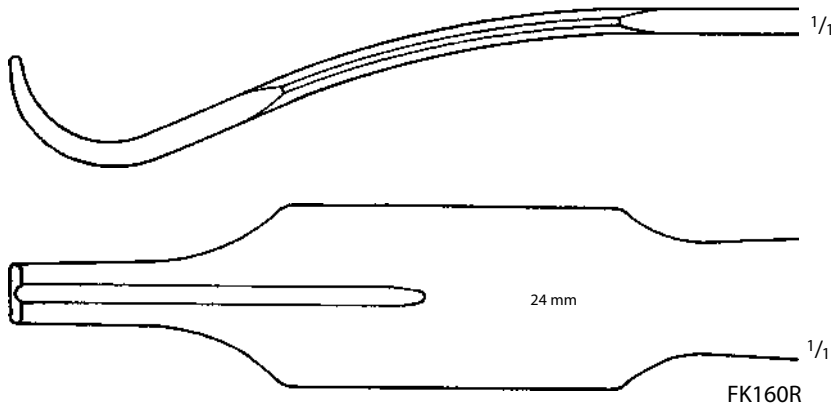

LANGE-HOHMANN Bone Retractor
 (continued)

Catalog Number	Blade Size (mm)	Length (in.)
FK161R	30	10 1/2
FK162R	33	11



FK161R-FK162R

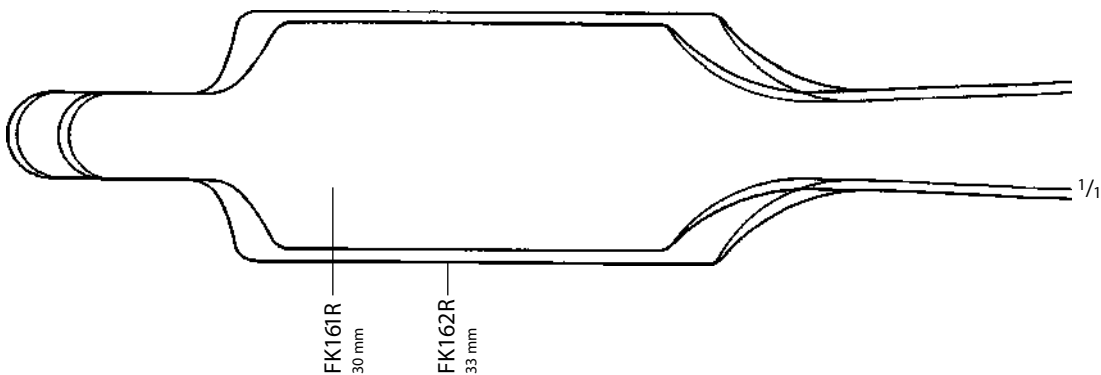
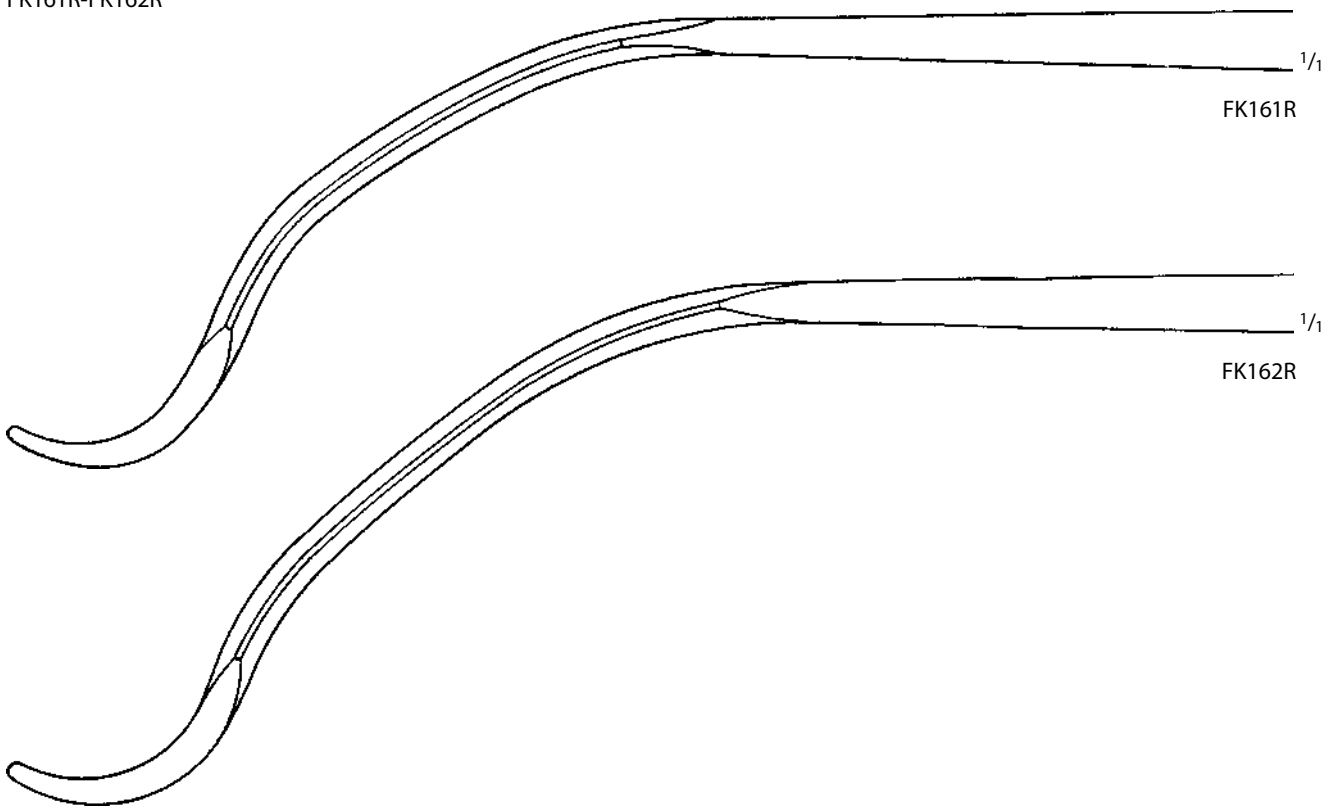



HOHMANN (WAGNER) Humoral Head Retractor

Catalog Number	Blade Size (mm)	Length (in.)
FK167R	17	8 3/4

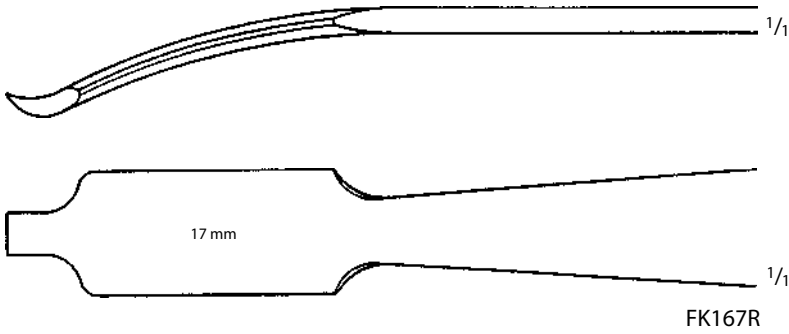

HOHMANN (ALDINGER) Bone Retractor

Catalog Number	Blade Size (mm)	Length (in.)
FK169R	24	10 5/8

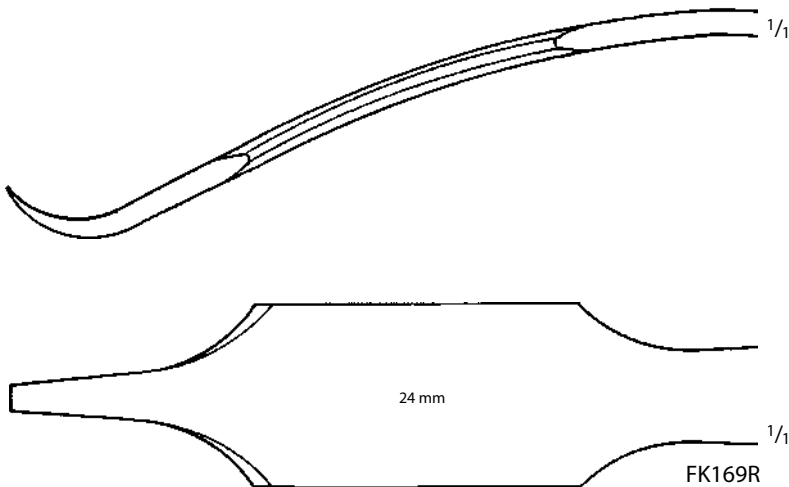



HOHMANN Bone Retractor

Catalog Number	Blade Size (mm)	Length (in.)
FK185R	8	8 3/4
FK186R	15	9 3/4
FK187R	22	11 3/4

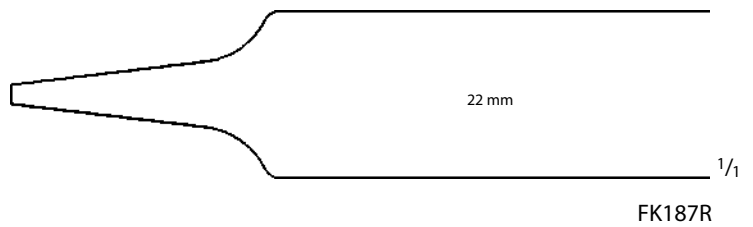
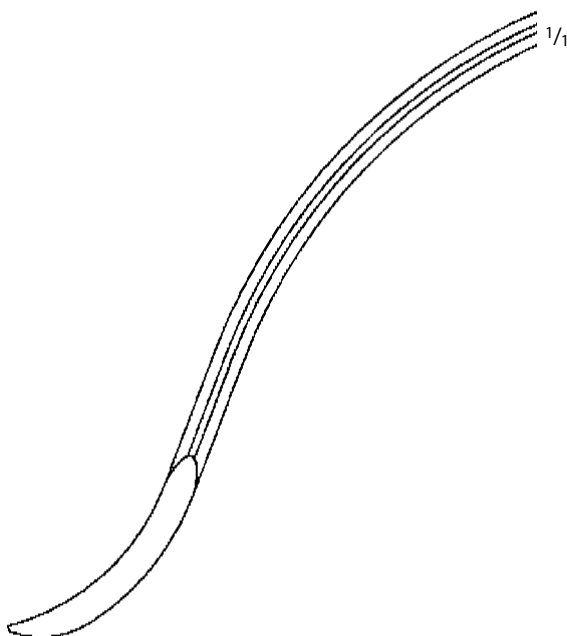
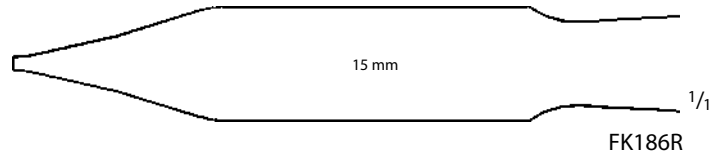
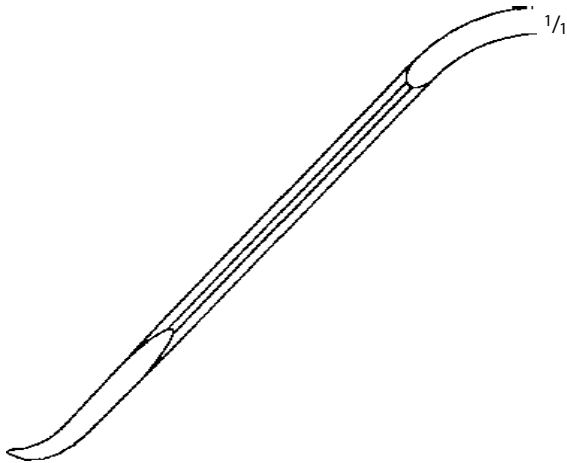
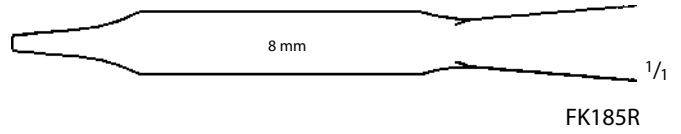

HOHMANN Bone Retractor (continued)

Catalog Number	Blade Size (mm)	Length (in.)
FK188R	43	9



FK188R

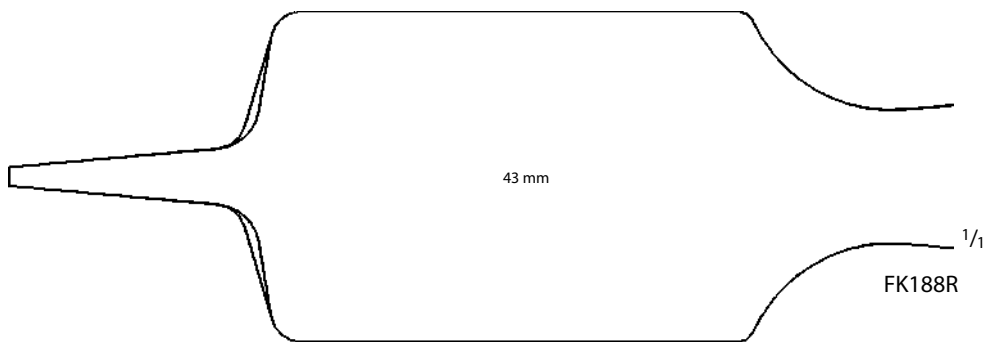
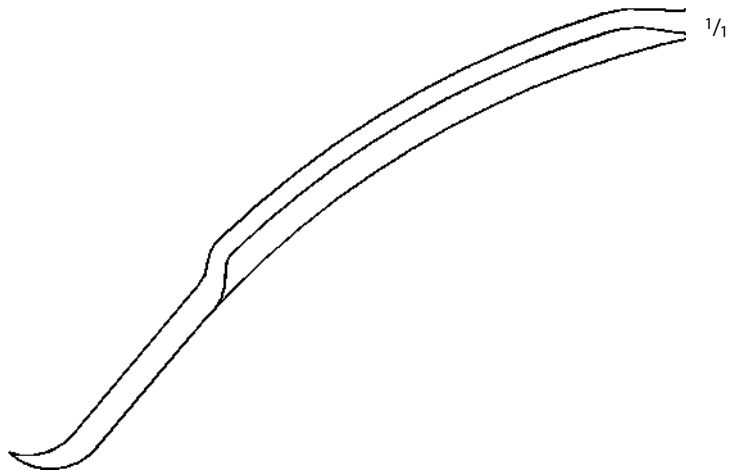

HOHMANN Bone Retractor (continued)

Catalog Number	Blade Size (mm)	Length (in.)
FK189R	40	11 1/2

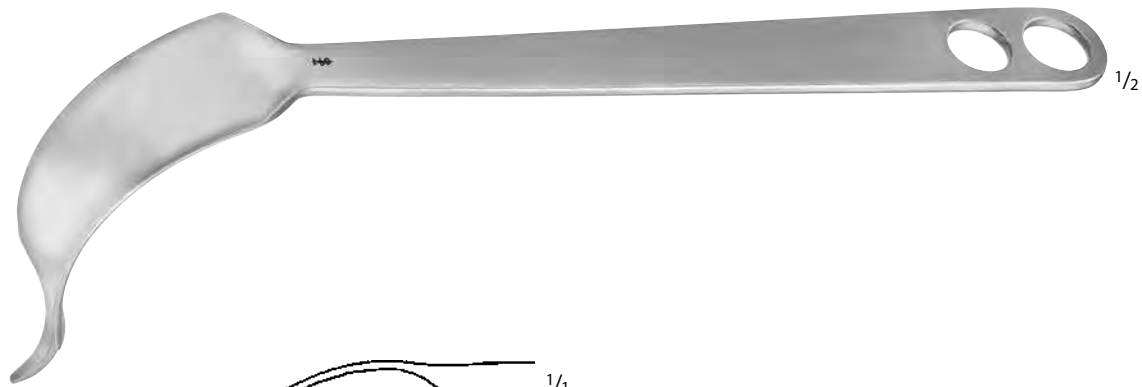

FK189R

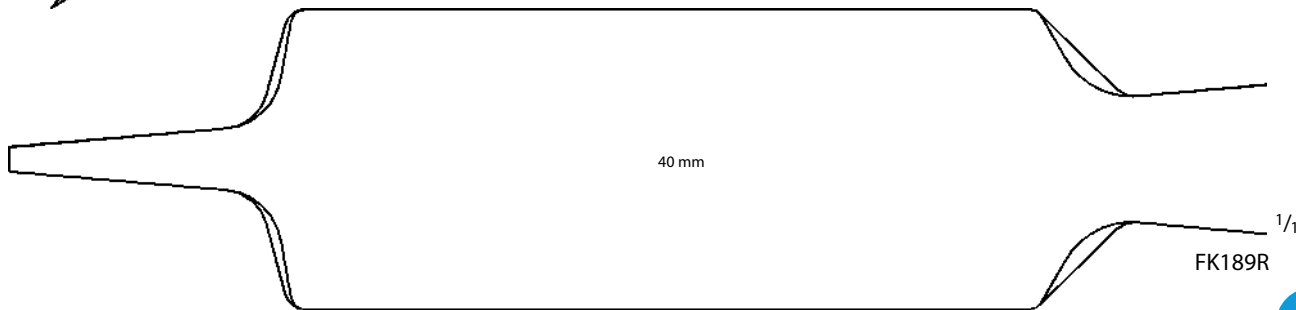
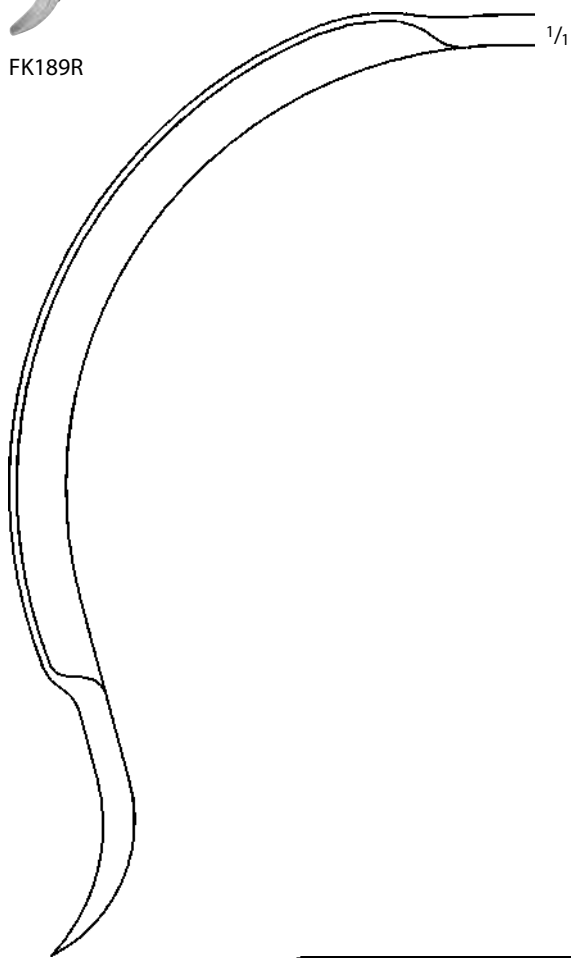

SCHUMACHER Modified WAGNER
 Bone Retractor

Catalog Number	Blade Size (mm)	Length (in.)
FK168R	37	14



FK168R



SCHUMACHER Bone Retractor

Catalog Number	Blade Size (mm)	Length (in.)
FK177R	35	11 1/2



FK177R

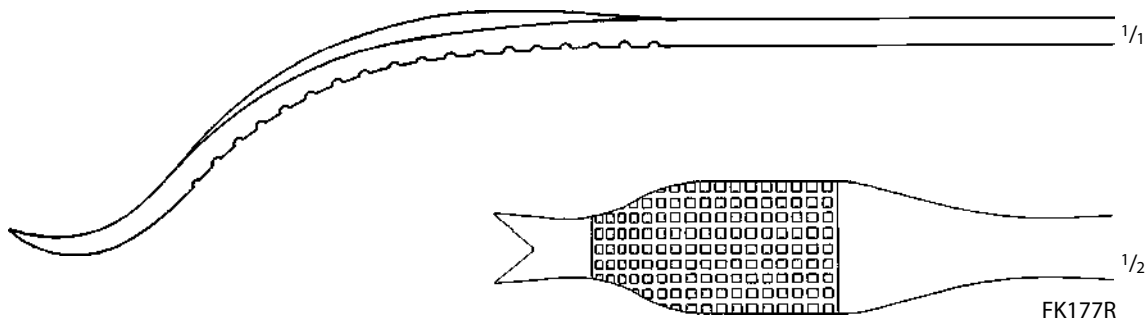

FK177R

VERBRUGGE-MÜLLER Bone Retractor

Catalog Number	Blade Size (mm)	Length (in.)
FK174R	44	9 1/2
FK175R	65	10



FK174R-FK175R

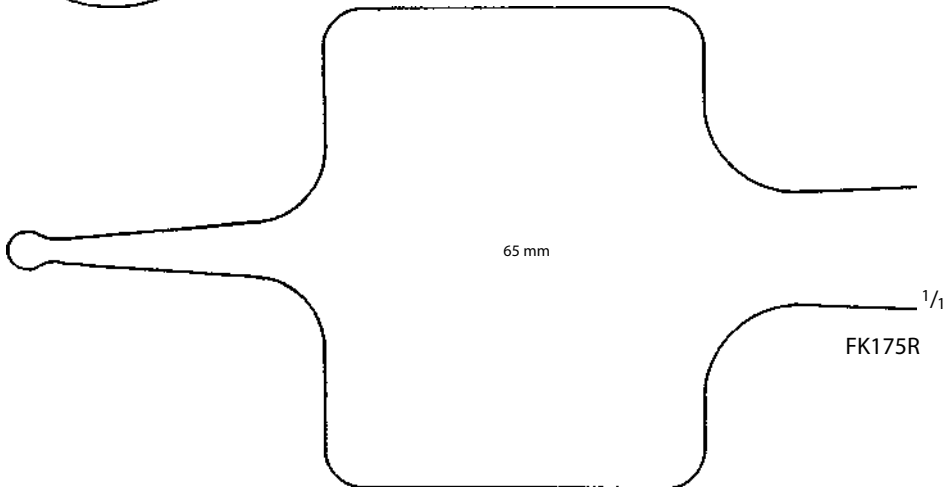
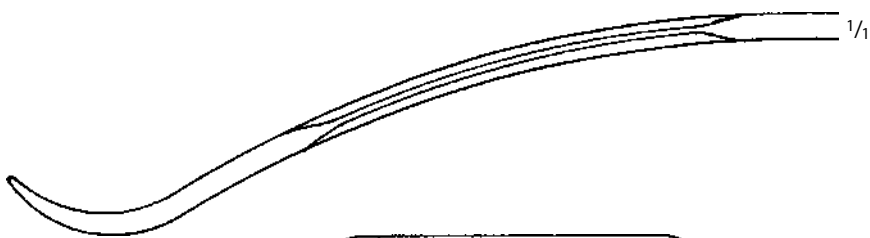
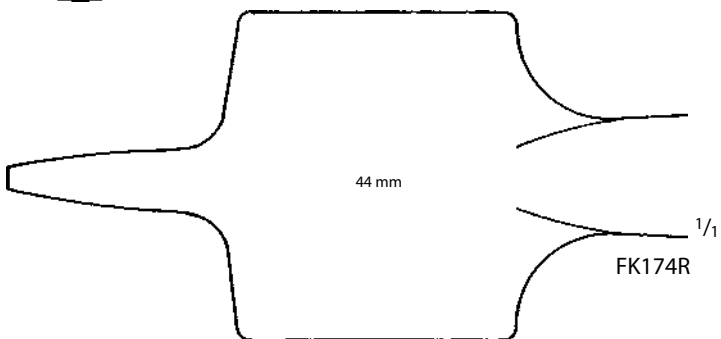
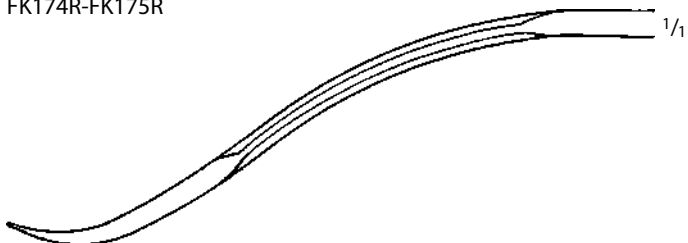

BENNETT Bone Retractor

Catalog Number	Blade Size (mm)	Length (in.)
FK180R	65	9 1/2
MD563	44	9 1/2



FK180R, MD563

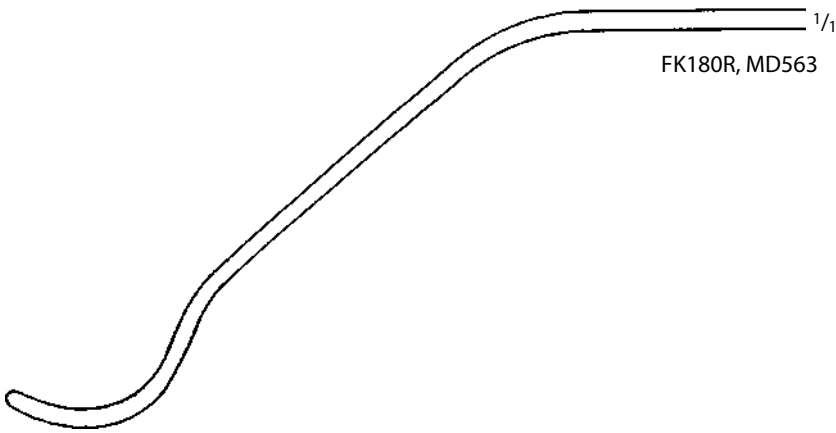

FK180R, MD563

MURPHY-LANE Bone Skid

Catalog Number	Blade Size (mm)	Length (in.)
FK193R	18 / 30	11 3/4



FK193R



FK193R

Bone Hook

Catalog Number	Tip	Blade End	Length (in.)
BT232R	SHARP	1 PRONG	9 5/8



BT232R

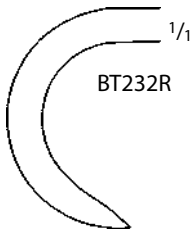

BT234R

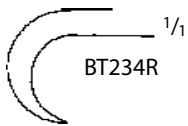

KOCHER Bone Hook

Catalog Number	Tip	Blade End	Length (in.)
BT234R	SHARP	1 PRONG	8
BT238R	SHARP	1 PRONG	8 3/4
BT239R	BLUNT	1 PRONG	8 3/4



BT238R

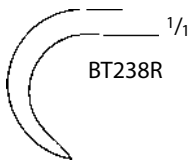

BT239R





BT240R

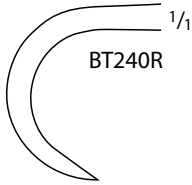

BT241R

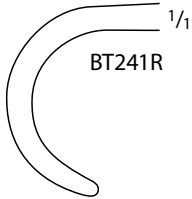

VOLKMANN Bone Hook

Catalog Number	Tip	Blade End	Length (in.)
BT240R	SHARP	1 PRONG	8 3/4
BT241R	BLUNT	1 PRONG	8 3/4



MB418R, MB974R

Bone Hooks

Catalog Number	Tip	Diameter (mm)	Length (in.)
MB974R	SHARP	19	9
MB975R	BLUNT	19	9
MB418R	SHARP	30	9



MB975R

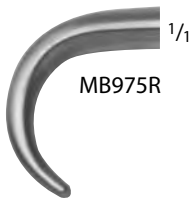



BV250R

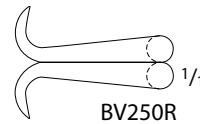

ANDERSON-ADSON Retractor

Catalog Number	Tip	Blade End	Length (in.)
BV250R	SHARP	4 x 4 PRONGS	7 1/2



BV248R

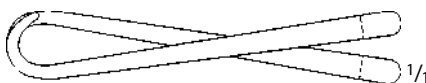

BV248R

NORFOLK-NORWICH Retractor

Catalog Number	Tip	Blade End	Length (in.)
BV248R	BLUNT	4 x 5 PRONGS	8 3/4



BV252R

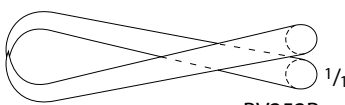

BV252R

ADSON Self Retaining Retractor

Catalog Number	Tip	Blade End	Length (in.)
BV252R	SHARP	3 x 4 PRONGS	10 1/2

Laminectomy Self Retaining Retractor

Catalog Number	Tip	Blade End	Length (in.)
BV254R	SHARP	6 x 6 PRONGS	11



BV254R

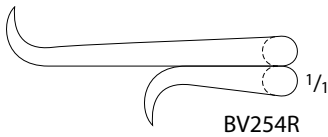

BV254R

ADSON Self Retaining Retractor,
 Hinged

Catalog Number	Tip	Blade End	Length (in.)
BV251R	SEMI-S	4 x 4 PRONGS	8 1/2



BV251R

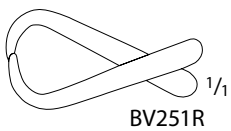

BV251R

HARVEY-JACKSON Retractor, Hinged

Catalog Number	Tip	Blade End	Length (in.)
BV258R	SHARP	3 x 3 PRONGS	11 3/4

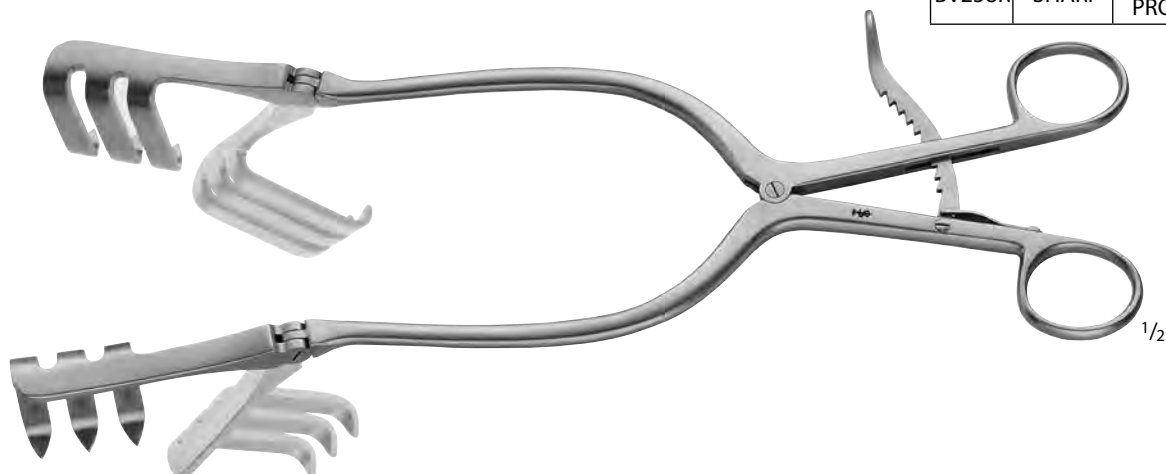

BV258R

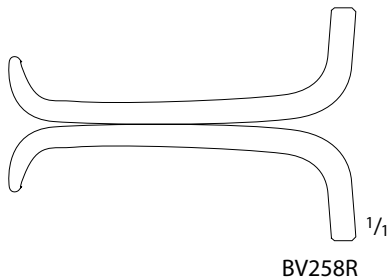

BV258R

BECKMANN-ADSON Retractor, Hinged

Catalog Number	Tip	Blade End	Length (in.)
BV271R	SEMI-S	4 x 4 PRONGS	12 1/4
BV272R	SHARP	4 x 4 PRONGS	12 1/4



BV271R-BV272R

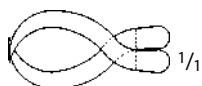

BV271R

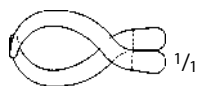

BV272R

ADSON Retractor, Hinged

Catalog Number	Tip	Blade End	Length (in.)
BV273R	SEMI-S	5 x 4 PRONGS	12 1/2

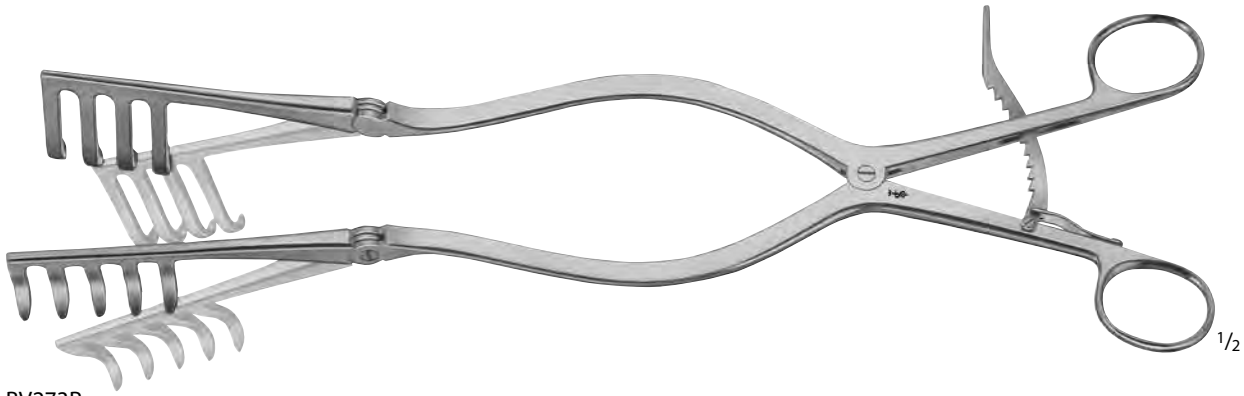

BV273R

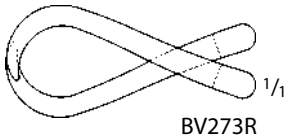

BV273R

BECKMANN Retractor, Hinged

Catalog Number	Tip	Blade End	Length (in.)
BV276R	SHARP	7 x 7 PRONGS	12 1/2



BV276R

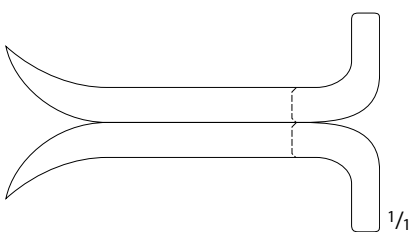

BV276R

BECKMANN Retractor, Hinged
 (continued)

Catalog Number	Tip	Blade End	Length (in.)
MG064R	SHARP	3 x 4 PRONGS	6 1/2
MG371R	BLUNT	3 x 4 PRONGS	6 1/4



MG064R

1/2



1/1

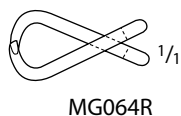

1/1

MG064R



MG371R

1/2



1/1

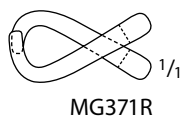

1/1

MG371R



MF061R

1/2

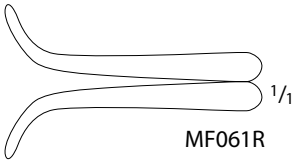

MF061R

1/1

MISKIMON Cerebellum Retractor

Catalog Number	Tip	Blade End	Length (in.)
MF061R	SEMI-S	7 x 7 PRONGS	7 1/2



MF065R-MF067R

1/2

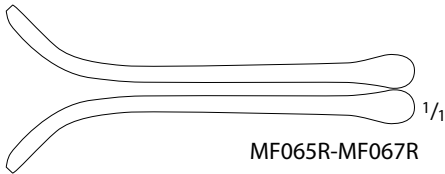

MF065R-MF067R

1/1

MEYERDING Retractor

Catalog Number	Blade Size (mm)	Length (in.)
MF065R	25 x 57	6 1/2
MF066R	25 x 51	6 1/2
MF067R	25 x 31	6 1/2



MF068R-MF079R

1/2

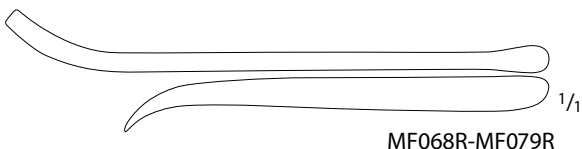

MF068R-MF079R

1/1

WILLIAMS Retractor

Catalog Number	Tip	Blade Size (mm)	Length (in.)
MF068R	BLADE LEFT	10 x 50	7
MF069R	BLADE RIGHT	10 x 50	7
MF070R	BLADE LEFT	10 x 60	7
MF071R	BLADE RIGHT	10 x 60	7
MF072R	BLADE LEFT	10 x 70	7
MF073R	BLADE RIGHT	10 x 70	7
MF074R	BLADE LEFT	20 x 50	7
MF075R	BLADE RIGHT	20 x 50	7
MF076R	BLADE LEFT	20 x 60	7
MF077R	BLADE RIGHT	20 x 60	7
MF078R	BLADE LEFT	20 x 70	7
MF079R	BLADE RIGHT	20 x 70	7



MF329R-MF332R

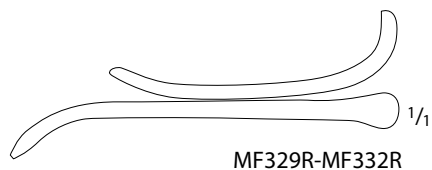

MF329R-MF332R

DUCKER Retractor

Catalog Number	Tip	Blade Size (mm)	Length (in.)
MF329R	HOOK LEFT	50 x 20	6 3/4
MF330R	HOOK RIGHT	50 x 20	6 3/4
MF331R	HOOK LEFT	70 x 20	6 3/4
MF332R	HOOK RIGHT	70 x 20	6 3/4

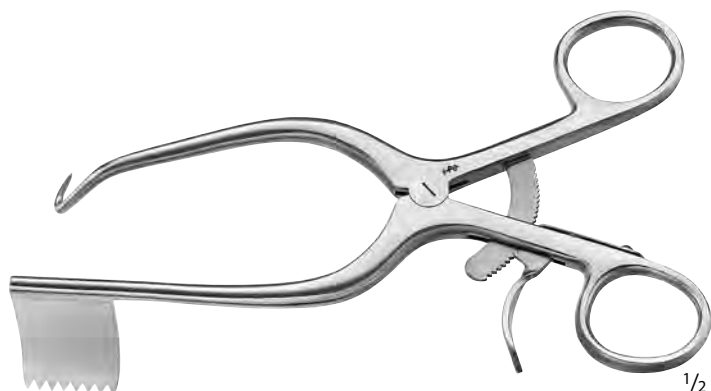

MF442R-MF443R

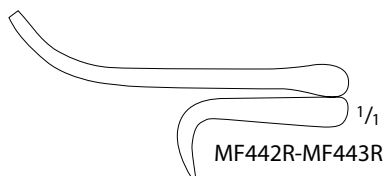

MF442R-MF443R

MARKHAM-MEYERDING Retractor

Catalog Number	Tip	Blade Size (mm)	Length (in.)
MF442R	BLADE RIGHT	46 x 26	7 1/2
MF443R	BLADE LEFT	46 x 26	7 1/2

Zelpi-Type Retractor, Deep Blade

Catalog Number	Tip	Depth (in.)
MD529R	ANG 45°	3
MD527R	ANG 90°	3
MD528R	ANG 90°	4
MD530R	ANG 90°	5



MD529R-MD530R

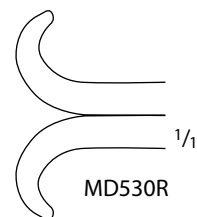
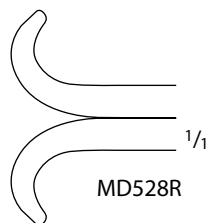
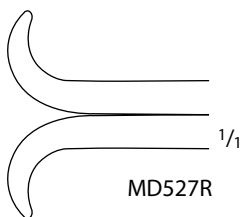
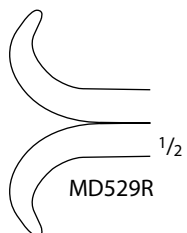



BV296R

CLOWARD Lamina Spreader

Catalog Number	Tip	Tip Size (mm)	Length (in.)
BV296R	SERR OUTER	5.0	6 1/8



BV299R

CLOWARD Lamina Spreader

Catalog Number	Tip	Tip Size (mm)	Length (in.)
BV299R	SERR	4.5	5 1/4



MB989R

INGE Lamina Spreader

Catalog Number	Tip	Length (in.)
MB989R	TOOTHED	6 1/2

INGE Lamina Spreader

Catalog Number	Tip	Tip Size (mm)	Length (in.)
BV297R	SERR	6.0	6 3/4



BV297R

INGE Lamina Spreader

Catalog Number	Tip	Tip Size (mm)	Length (in.)
BV298R	TOOTHED	12.0	



BV298R



Ball Snap System on Spreaders and Blades

Advantages:

- Blades are safely locked without additional fixation, preventing them from detaching when the instrument is passed to the surgeon. In addition, the smooth surface minimizes the risk of catching a suture.
- Blades can be quickly exchanged during the operation.
- Different retractor patterns can be combined and exchanged at random, which allows for optimum selection of the blade size according to surgical needs.

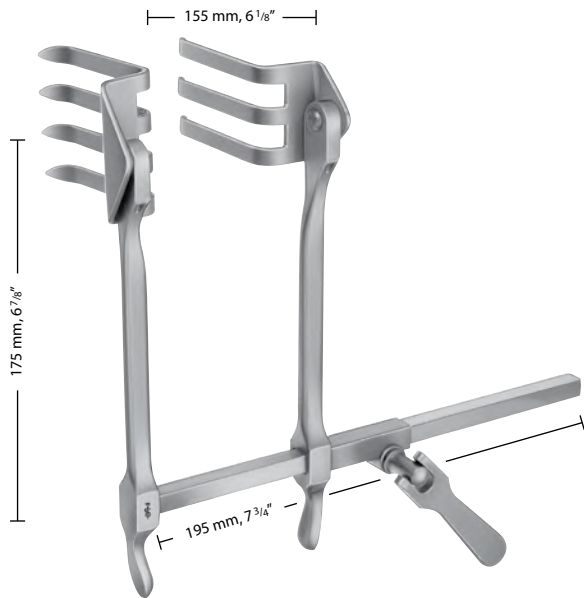

BV510R

SCOVILLE-RICHTER Laminectomy Retractor, Reversible

Catalog Number	Description
BV510R	COMPLETE

BV510R Includes:

- 1 Retractor BV509R and
 - 1 Pair of blades BV516R
- The retractor bar and shanks rotate 180°



BV516R



BV517R



BV518R



BV519R

SCOVILLE-RICHTER Retractor Blade

Catalog Number	Blade Size (mm)
BV516R	62 x 52 AND 62 x 37, PAIR
BV517R	47 x 51
BV518R	30 x 40
BV519R	37 x 62

- Complete retraction system consisting of a retractor body, various blade configurations, and storage tray. Designed to enable less invasive spine procedures such as discectomies and decompressions.
 - Unique organization system enables easy storage and retrieval of desired blade.
 - Sturdy design provides rigid retraction even at large opening widths.
- All retractor components are titanium. Blade designs improve visualization and intra-operative imaging.

MF393 Includes:

- 1 Hinged Titanium Retractor Frame MF365T
- 2 Wide Blades, 40 mm MF368T
- 2 Wide Blades, 50 mm MF369T
- 2 Wide Blades, 60 mm MF370T
- 2 Wide Blades, 70 mm MF371T
- 2 Narrow Blades, 40 mm MF375T
- 2 Narrow Blades, 50 mm MF376T
- 2 Narrow Blades, 60 mm MF377T
- 2 Narrow Blades, 70 mm MF378T
- 1 Storage Tray MF392
- 1 Hook Blade, 30 mm MF381T
- 1 Hook Blade, 40 mm MF382T
- 1 Hook Blade, 50 mm MF383T
- 1 Hook Blade, 60 mm MF384T
- 1 Toothed Blade, 30 mm MF387T
- 1 Toothed Blade, 40 mm MF388T
- 1 Toothed Blade, 50 mm MF389T
- 1 Toothed Blade, 60 mm MF390T

Spine Retractor System

Catalog Number
MF393

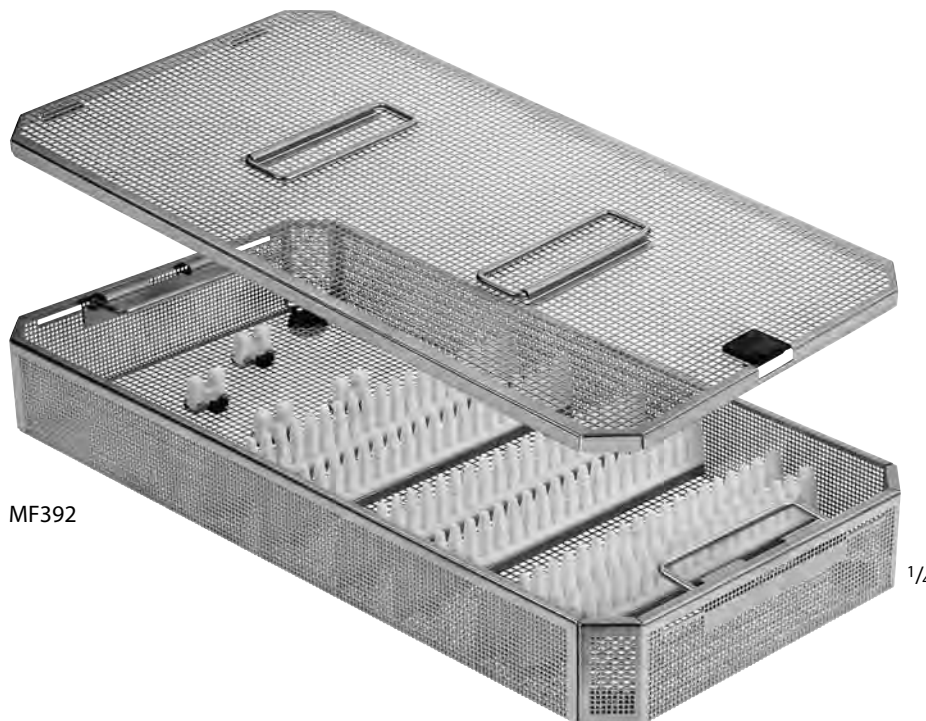

MF392

Storage Tray for Spine Retractor System

Catalog Number
MF392

The storage tray will fit into



MF365T

Titanium Retractor Frame, Hinged

Catalog Number
MF365T

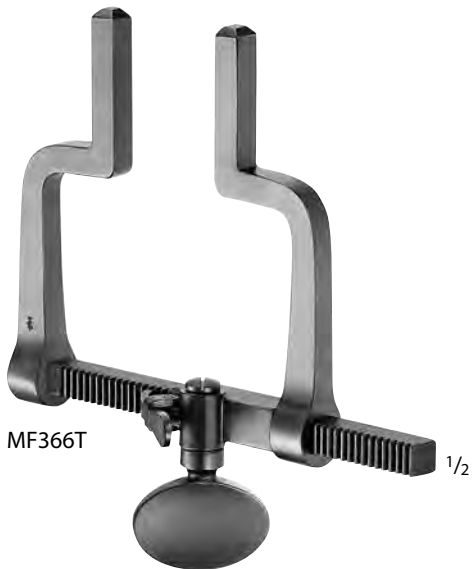

MF366T

Titanium Retractor Frame, Rigid

Catalog Number
MF366T



MF367T-MF373T

Titanium Retractor Blade, Wide

Catalog Number	Blade Size (mm)
MF367T	27 x 30
MF368T	27 x 40
MF369T	27 x 50
MF370T	27 x 60
MF371T	27 x 70
MF372T	27 x 80
MF373T	27 x 90



MF374T-MF380T

Titanium Retractor Blade, Narrow

Catalog Number	Blade Size (mm)
MF374T	20 x 30
MF375T	20 x 40
MF376T	20 x 50
MF377T	20 x 60
MF378T	20 x 70
MF379T	20 x 80
MF380T	20 x 90

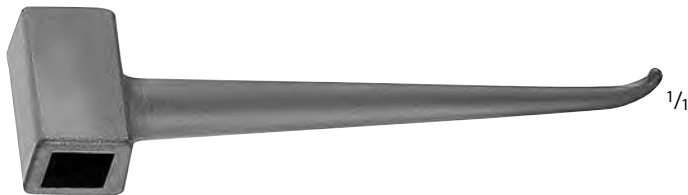

MF381T-MF386T

Titanium Retractor Hook

Catalog Number	Length (mm)
MF381T	30
MF382T	40
MF383T	50
MF384T	60
MF385T	70
MF386T	80



MF387T-MF391T

Titanium Toothed Blades

Catalog Number	Length (mm)
MF387T	30
MF388T	40
MF389T	50
MF390T	60
MF391T	70

CHARNLEY Initial Incision Retractor

Catalog Number	Description	Blade	Size	Blade Size (mm)
MB191R	SET COMPLETE	-	-	-
MB156R	INDIVIDUAL BLADE	SMALL	STANDARD DEPTH	25 x 38
MB177R	INDIVIDUAL BLADE	SMALL	MEDIUM DEPTH	25 x 75
MB192R	INDIVIDUAL BLADE	SMALL	LONG DEPTH	25 x 127
MB157R	INDIVIDUAL BLADE	LARGE	STANDARD DEPTH	25 x 44
MB178R	INDIVIDUAL BLADE	LARGE	MEDIUM DEPTH	25 x 75
MB193R	INDIVIDUAL BLADE	LARGE	LONG DEPTH	25 x 127
MG081R	WEIGHT AND CHAIN REPLACEMENT FOR MB191R	-	-	-

MB191R includes:

- 1 frame
- 1 small retractor blade (MB156R)
- 1 large retractor blade (MB157R)
- 1 weight w/ chain (3 lbs.)

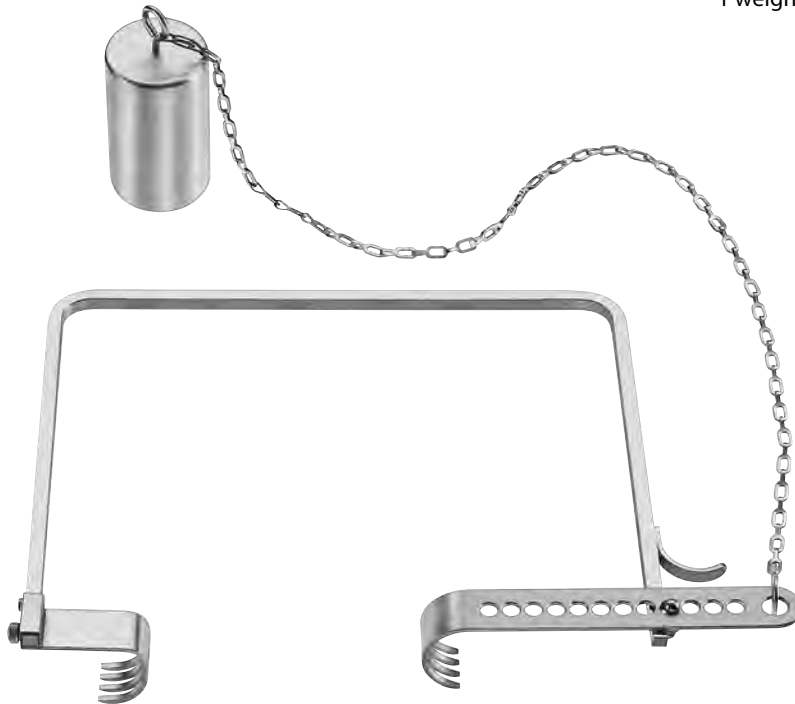

MB191R-MG081R



FK507R

Bone File/Rasp

Catalog Number	Tip Size (mm)	Length (in.)
FK507R	20	8 3/4

One Side File Cut
 One Side Rasp Cut



FK507R

Bone File

Catalog Number	Tip Size (mm)	Length (in.)
FK511R	13	9 1/2
FK510R	20	11 5/8



FK511R

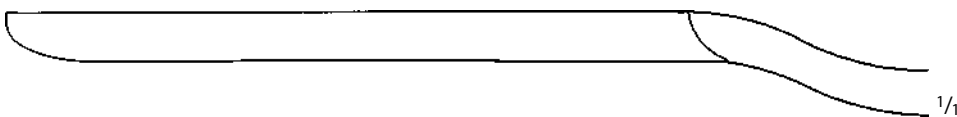

FK511R



FK510R



DUROGRIP™ TC FOMON Rasp, Double Ended

Catalog Number	Size	Teeth	Length (in.)
OL423R	3 + 4	16/20	8 1/4
OL425R	5 + 6	24/30	8 1/4
OL427R	7 + 8	36/44	8 1/4
OL429R	9 + 10	52/44	8 1/4

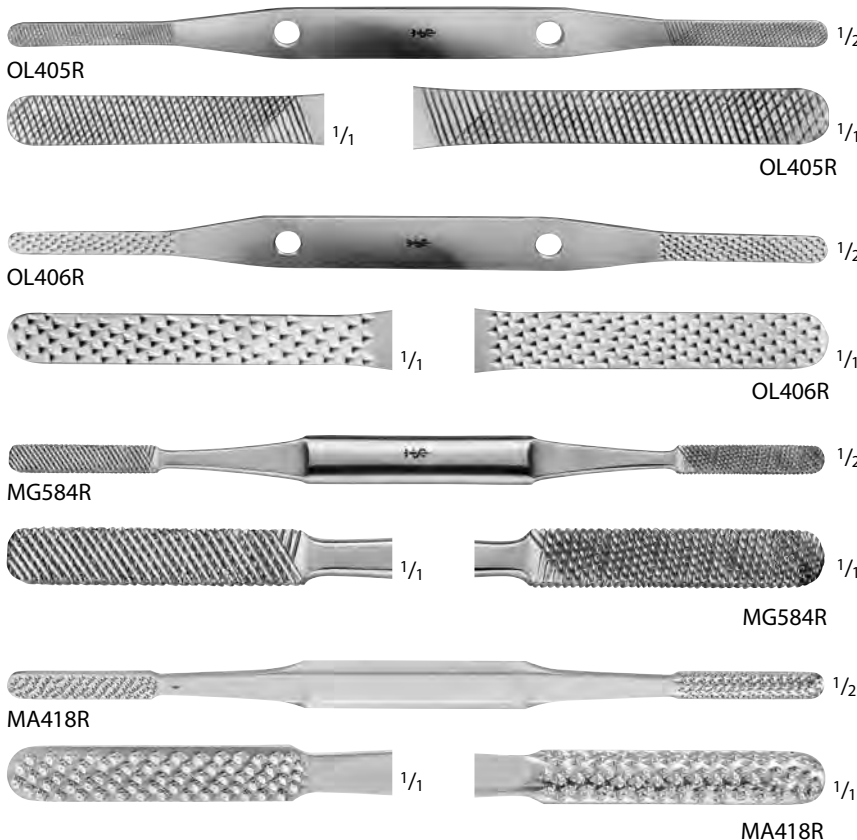
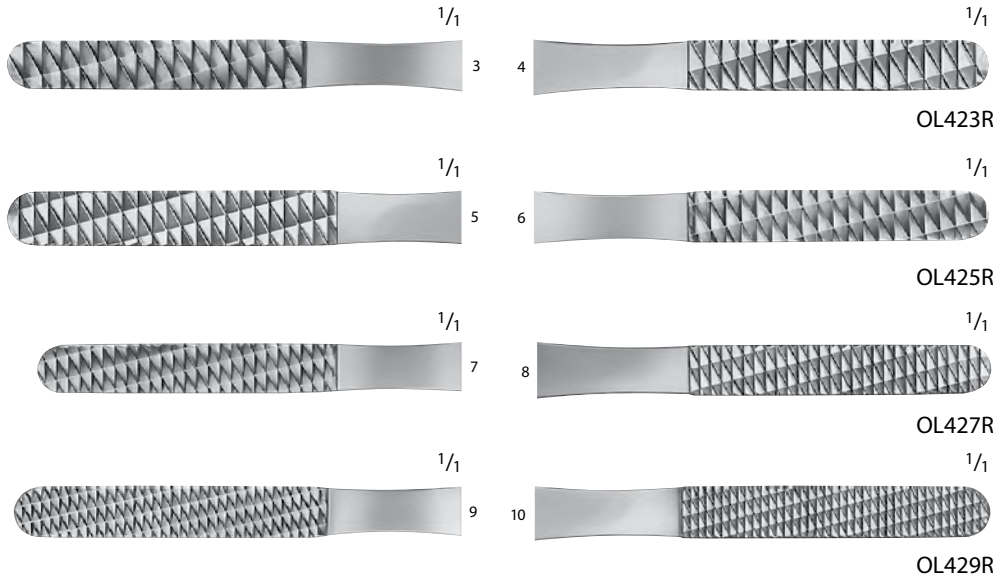

FOMON Bone Rasp, Double Ended

Catalog Number	Tip Size (mm)	Tip	Length (in.)
OL405R	6.5 / 7.5	X-SERR Fine/Coarse	8 1/2
OL406R	6.5 / 7.5	Fine/Coarse	8 1/2
MG584R	8/8	FLAT, CONVEX FINE, COARSE	8 1/2
MA418R	7.5 / 7.5	Coarse/ Xtra-Coarse	8 3/8

Let Us know if you could not find what you are looking for



OL407R

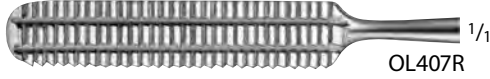

OL407R



MA419R



MA420R



OL408R-OL409R

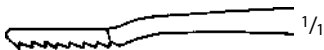

1/1



OL408R



OL409R



FK301R-FK302R



1/1

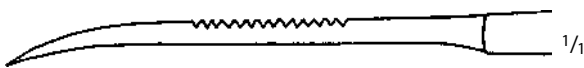

FK301R



1/1

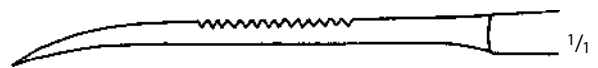

FK302R

MALTZ Bone Rasp

Catalog Number	Tip Size (mm)	Tip	Length (in.)
OL407R	9	DOWN-STROKE	6 1/2
MA419R	33	DOWN-STROKE	6 1/2
MA420R	33	UP STROKE	6 1/2

LEWIS Bone Rasp

Catalog Number	Tip	Tip Size (mm)	Length (in.)
OL408R	FINE-SERR DOWN-STROKE	8	6 7/8
OL409R	COARSE-SERR DOWN-STROKE	8	6 7/8

Bone Raspatory

Catalog Number	Blade Size (mm)	Length (in.)
FK301R	6	6 1/2
FK302R	8	6 1/2

PUTTI Bone File, Double Ended

Catalog Number	Tip Size (mm)	Length (in.)
FK505R	18/20	10 5/8



FK505R

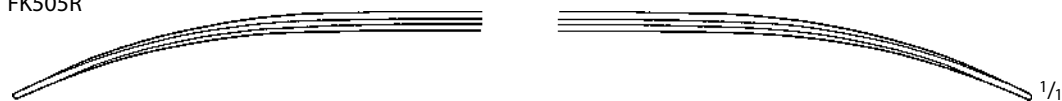

FK505R



MB816R-MB817R

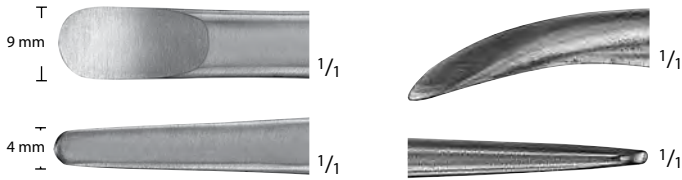

MB816R-MB817R



FK300R

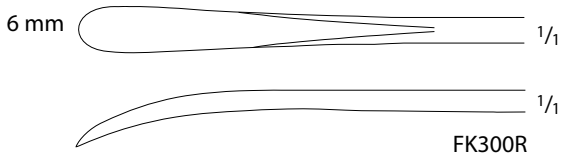

FK300R



FK306R-FK309R

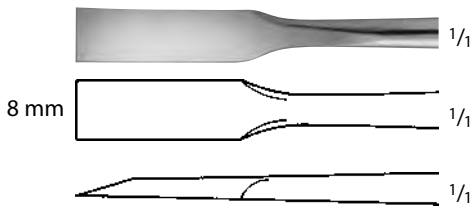

FK306R



FK308R

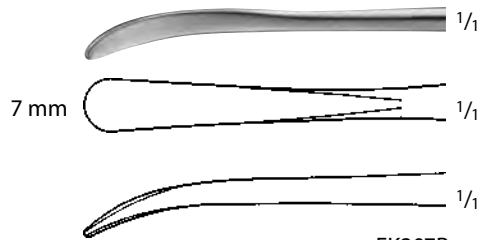

FK307R



FK309R

SAYRE Periosteal Elevator

Catalog Number	Tip	Length (in.)
MB816R	SHARP	6 3/4
MB817R	BLUNT	6 3/4

WILLIGER Bone Elevator

Catalog Number	Blade Size (mm)	Length (in.)
FK300R	6	6 1/4

ADSON Elevator

Catalog Number	Tip	Blade Size (mm)	Blade	Length (in.)
FK306R	SHARP	8	STR	6 3/4
FK308R	SEMI-S	7	STR	6 3/4
FK307R	BLUNT	7	CVD	6 3/4
FK309R	SHARP	7	CVD	6 3/4

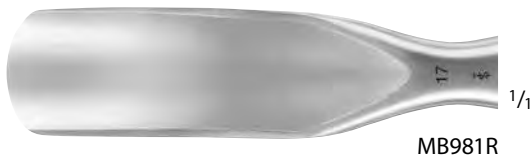
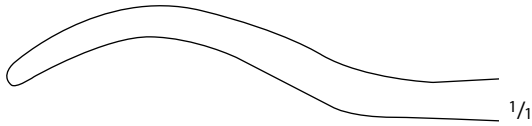

MCGLAMRY Metatarsal Elevators

Catalog Number	Blade Size (mm)	Length (in.)
MB978R	11	6 1/2
MB979R	13	6 1/2
MB980R	15	6 1/2
MB981R	17	6 1/2

Let Us know if you could not find what you are looking for



FK323R

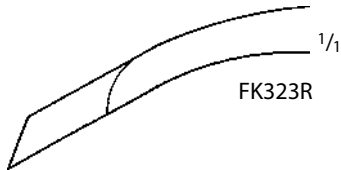

Elevator W/ PEEK Handle

Catalog Number	Tip	Blade Size (mm)	Blade	Length (in.)
FK323R	SHARP	13	CVD	6 7/8



FK324R

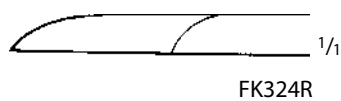

Elevator W/ PEEK Handle

Catalog Number	Tip	Blade Size (mm)	Blade	Length (in.)
FK324R	SHARP	14	STR	7 1/2



FK325R

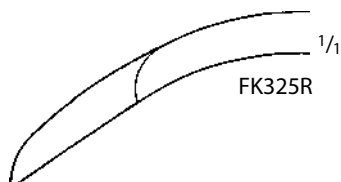

Elevator W/ PEEK Handle

Catalog Number	Tip	Blade Size (mm)	Blade	Length (in.)
FK325R	SHARP	14	CVD	7



FK360R

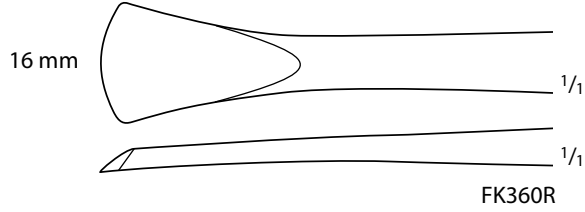

MB279R

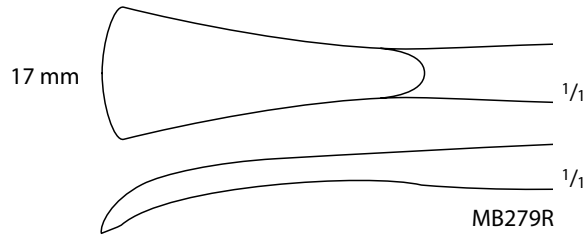

FK350R

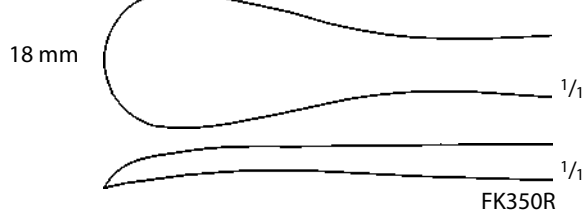

FK351R

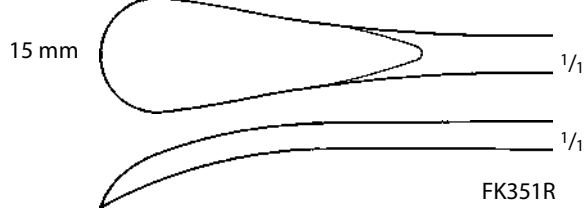

MB536R



LANGENBECK Periosteal Elevator

Catalog Number	Blade Size (mm)	Blade	Length (in.)
FK360R	16	STR	7 1/2
MB279R	17	STR	7 3/4

SEDILLOT Elevator

Catalog Number	Blade Size (mm)	Blade	Length (in.)
FK350R	18	STR	7 1/4
FK351R	15	CVD	8 1/2

KEY Periosteal Elevator

Catalog Number	Blade Size (mm)	Length (in.)
MB536R	3.1	6 3/4



FK410R-FK414R

KEY Elevator

Catalog Number	Blade Size (mm)	Blade	Length (in.)
FK410R	6.4	STR	7
FK411R	9.5	STR	7 1/2
FK412R	12.7	STR	7 1/2
FK413R	19	STR	7 7/8
FK414R	25.4	STR	8 1/4



MG024R

COBB Elevator, Round

Catalog Number	Blade Size (mm)	Blade	Length (in.)
MG024R	19	CVD	9 1/2

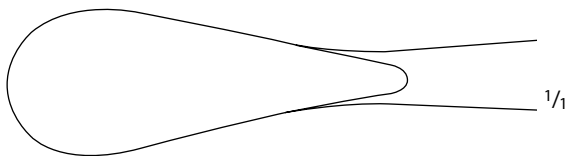

MG024R

COBB Elevator, Sharp

Catalog Number	Blade Size (mm)	Blade	Length (in.)
FK146R	10	CVD	11
FK147R	13	CVD	11
FK148R	19	CVD	11

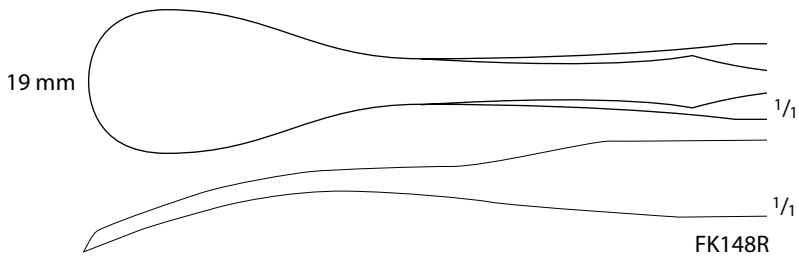
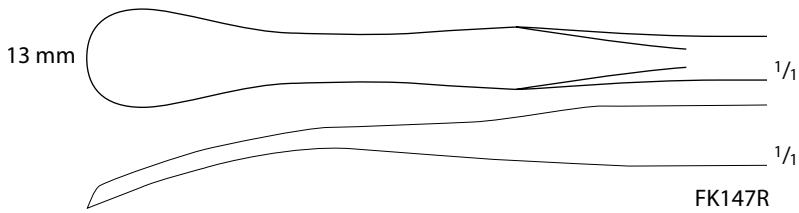
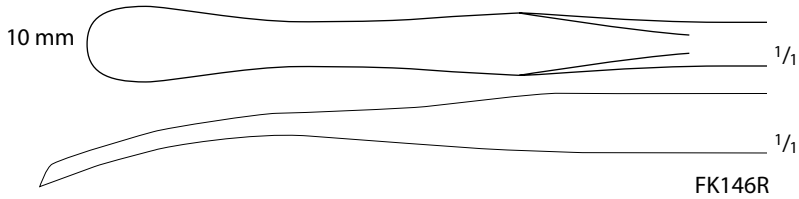

COBB Periosteal Elevator, Round

Catalog Number	Blade Size (mm)	Blade	Length (in.)
MB518R	7	CVD	12



COBB Elevator

Catalog Number	Blade Size (mm)	Blade	Length (in.)
MD645	10	ROUND	11
MD646	13	ROUND	11
MD647	19	ROUND	11
MD648	26	ROUND	11
MD649	32	ROUND	11



MD645-MD649

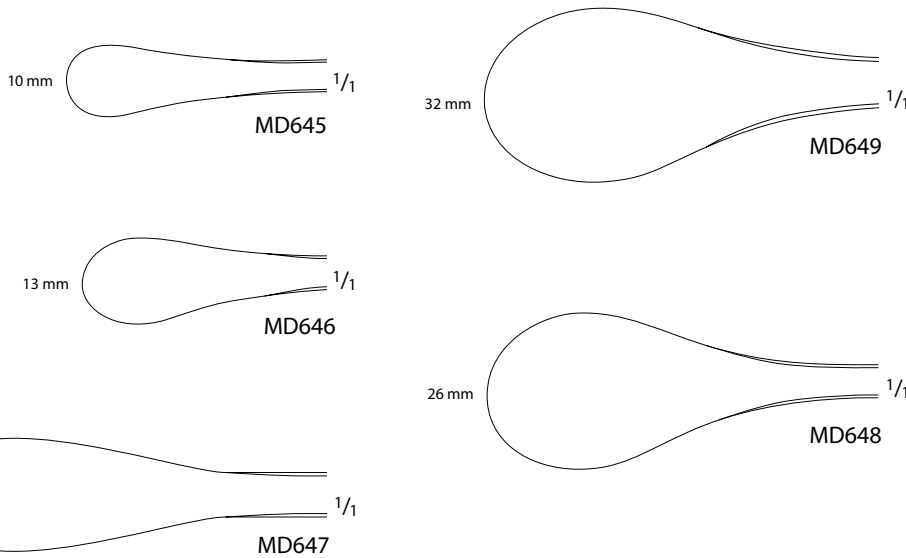

Elevator W/ PEEK Handle

Catalog Number	Blade Size (mm)	Blade	Length (in.)
FK348R	20	CVD	11 1/2



FK348R

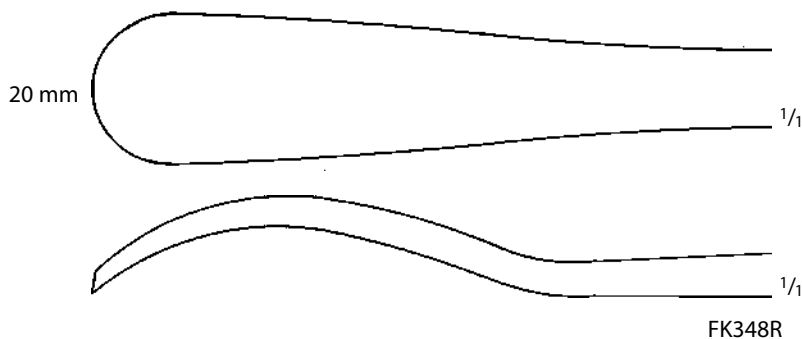

FK348R

WAGNER Elevator W/ PEEK Handle

Catalog Number	Blade Size (mm)	Blade	Length (in.)
FK352R	8	CVD	13
FK353R	17	CVD	13



FK352R-FK353R

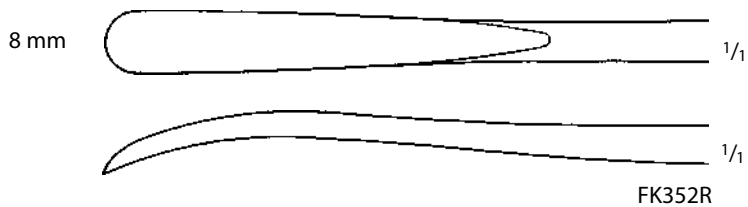

FK352R

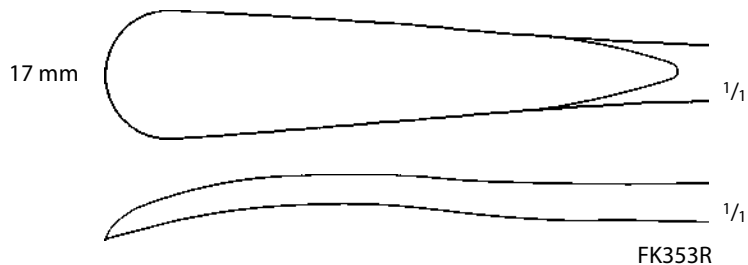

FK353R



MN001R-MN006R

1/3



MN001R

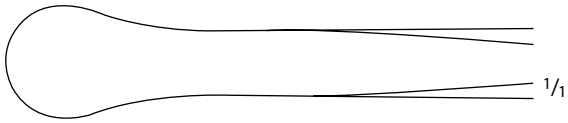

MN002R

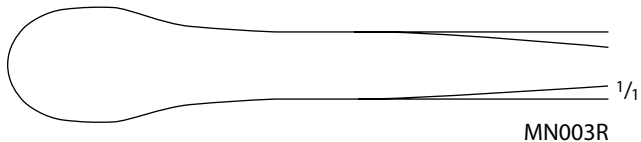

MN003R

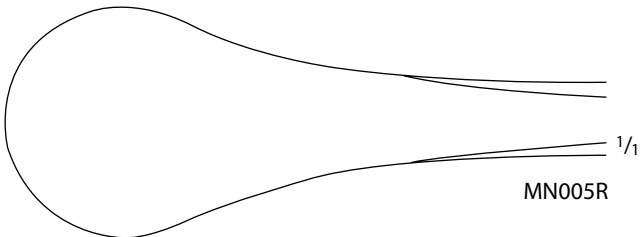

MN005R

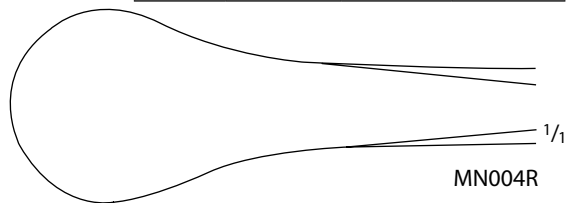

MN004R

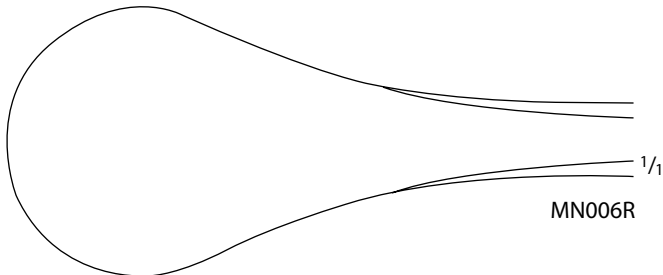

MN006R



MN007R-MN011R

1/3

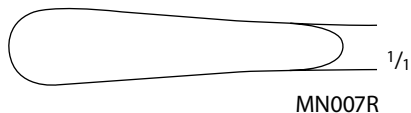

MN007R

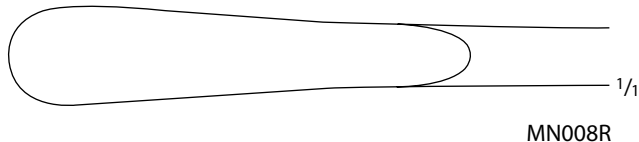

MN008R

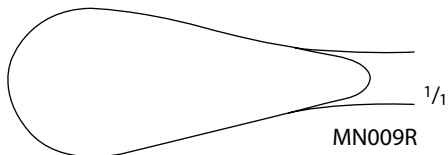

MN009R

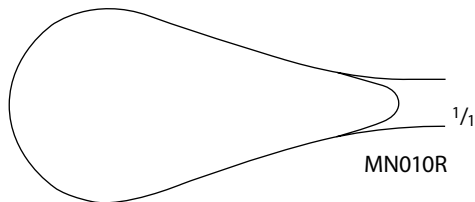

MN010R

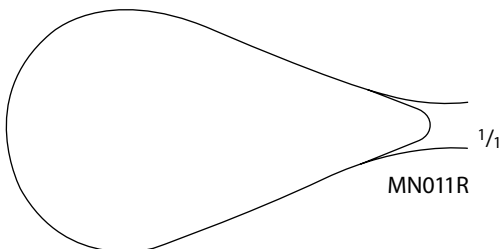

MN011R

Black Handled Elevator

Catalog Number	Tip Size (mm)	Handle	Length (in.)
MN001R	10	8 1/2	13 1/4
MN002R	15	8 1/2	13 1/4
MN003R	20	8 1/2	13 1/4
MN004R	25	8 1/2	13 1/4
MN005R	30	8 1/2	13 1/4
MN006R	35	8 1/2	13 1/4
MN007R	9	9	15
MN008R	13	9	15
MN009R	19	9	15
MN010R	25	9	15
MN011R	32	9	15

Let Us know if you could not find what you are looking for



FK120R

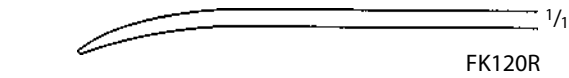

FK120R



FK121R

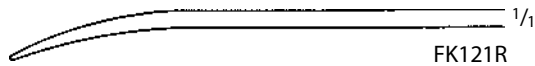

FK121R



FK124R

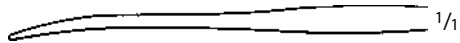
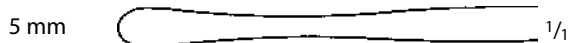

FK124R

WILLIGER Elevator

Catalog Number	Blade Size (mm)	Blade	Length (in.)
FK120R	5	CVD	6 1/2
FK121R	5.5	CVD	6 3/4

SEBILEAU Elevator

Catalog Number	Blade Size (mm)	Blade	Length (in.)
FK124R	5	CVD	6 7/8



FK130R-FK131R

LANGENBECK Elevator

Catalog Number	Blade Size (mm)	Blade	Length (in.)
FK130R	8	CVD	7 3/4
FK131R	10	CVD	7 3/4
FK139R	11	CVD	9

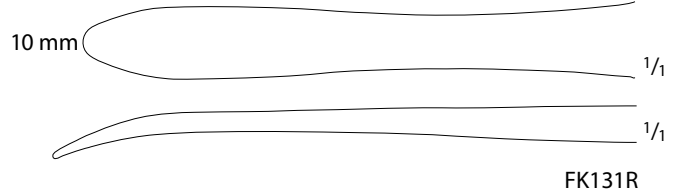
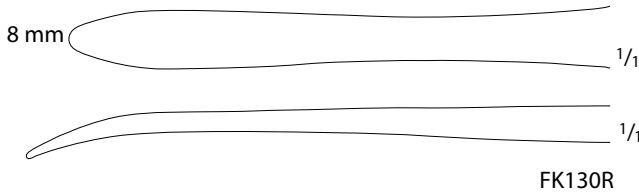

FK139R

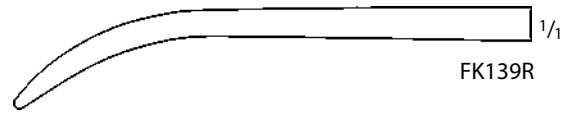
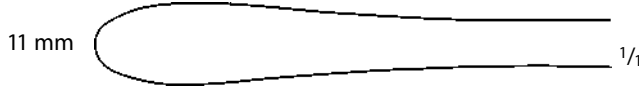

FK133R

QUERVAIN Elevator, Joker

Catalog Number	Blade Size (mm)	Blade	Length (in.)
FK133R	6	CVD	7 3/4

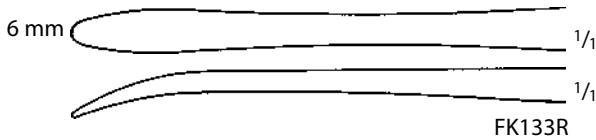

FK135R

LANE TRETOWAN Bone Lever

Catalog Number	Blade	Length (in.)
FK135R	CVD	8 1/2

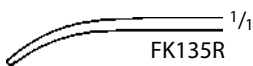

FK136R

LANE Bone Lever

Catalog Number	Blade	Length (in.)
FK136R	CVD	10

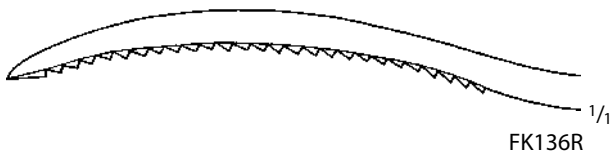



MB818R-MB820R



CREGO Elevator

Catalog Number	Tip	Blade Size (mm)	Blade	Length (in.)
MB818R	BLUNT	6.5	CVD	8
MB819R	BLUNT	7.1	CVD	8
MB820R	BLUNT	14.6	CVD	8



BRISTOW Bone Lever

Catalog Number	Length (in.)
FK140R	5 3/4





FK158R

TAEGER Bone Lever F/ Angle Joint
 Operations

Catalog Number	Blade Size (mm)	Blade	Length (in.)
FK158R	12	CVD	6 7/8

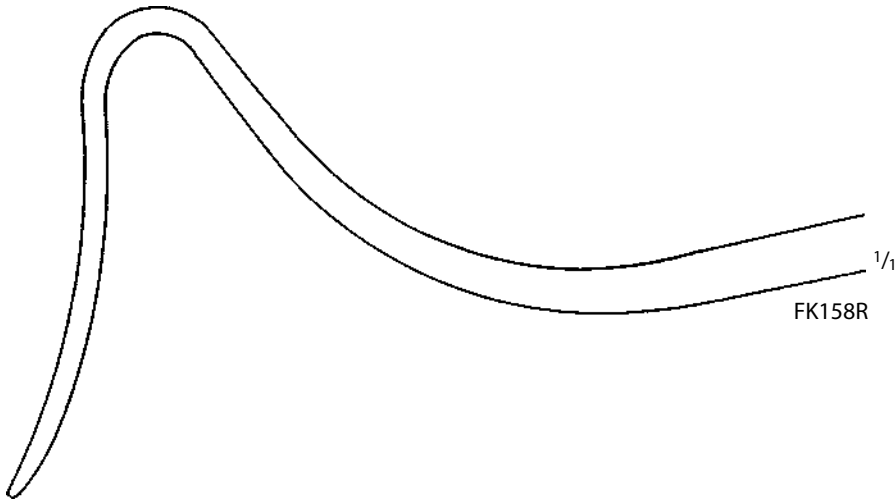

CHANDLER Bone Elevator

Catalog Number	Blade Size (mm)	Blade	Length (in.)
MB275R	14	SMALL	7 1/4
MB276R	19	MEDIUM	8
MB277R	25	LARGE	9 1/4
MB278R	30	EXTRA LARGE	10



MB275R-MB278R

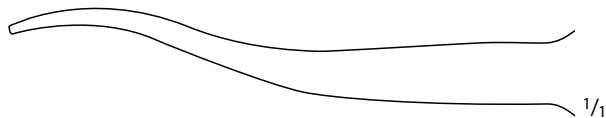

MB275R

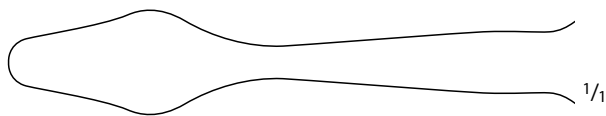

MB276R

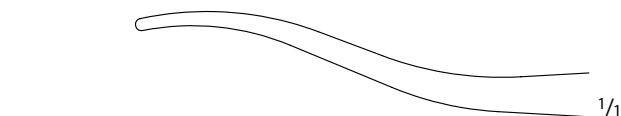

MB277R



MB278R



HIBBS Chisel



Catalog Number	Tip Size (mm)	Blade	Length (in.)
MB850R	7	STR	9 1/2
MB991R	10	STR	9 1/2
MB851R	15	STR	9 1/2
MB852R	19	STR	9 1/2
MB853R	22	STR	9 1/2
MB854R	25	STR	9 1/2
MB855R	38	STR	9 1/2
MB856R	7	CVD	9 1/2
MB857R	9	CVD	9 1/2
MB992R	13	CVD	9 1/2
MB858R	15	CVD	9 1/2
MB859R	19	CVD	9 1/2
MB993R	22	CVD	9 1/2
MB994R	25	CVD	9 1/2
MB995R	32	CVD	9 1/2
MB996R	38	CVD	9 1/2



STILLE Chisel



Catalog Number	Tip Size (mm)	Length (in.)
FL503R	10	8
FL504R	12	8
FL505R	15	8
FL506R	20	8
FL507R	25	8

Chisel Handle F/ Interchangeable Blades

Catalog Number	Item
FL665R	HANDLE W/KEY
GB020R	REPLACEMENT KEY

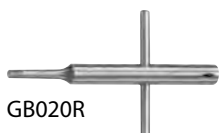

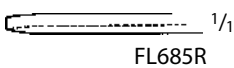
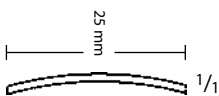
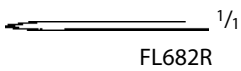
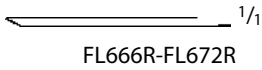

Chisel Blade, F/FL665R

Catalog Number	Tip Size (mm)	Tip Size (in.)	Working Length (mm)
FL666R	5	3/16	45
FL668R	10	3/8	45
FL670R	16	5/8	45
FL672R	25	1	45

Osteotome Blade, F/FL665R

Catalog Number	Tip Size (mm)	Tip Size (in.)	Working Length (mm)
FL682R	25	1	78

Concave Chisel Blade, F/FL665R

Catalog Number	Radius (mm)	Tip Size (mm)	Tip Size (in.)
FL685R	50	25	1
FL687R	70	25	1

Lamina Gouge W/ HARTPRESS
Handle

Catalog Number	Tip Size (mm)	Tip Size (in.)	Length (in.)
FL437R	6	1/4	9 1/4
FL438R	8	5/16	9 1/4
FL439R	11	7/16	9 1/4
FL440R	16	5/8	9 1/4



FL437R-FL440R



FL437R-FL440R

Chisel W/ PEEK Handle

Catalog Number	Tip Size (mm)	Tip Size (in.)	Length (in.)
FL430R	20	3/4	9 5/8



FL430R

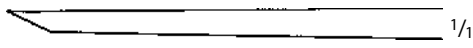

FL430R



FL390R-FL394R

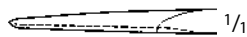

FL390R-FL394R

LEXER-MINI Gouge W/ PEEK Handle

Catalog Number	Tip Size (mm)	Tip Size (in.)	Length (in.)
FL390R	4	5/32	7
FL391R	6	1/4	7
FL392R	8	5/16	7
FL393R	10	3/8	7
FL394R	12	1/2	7



FL411R-FL418R



FL411R-FL418R

LEXER Gouge W/ PEEK Handle

Catalog Number	Tip Size (mm)	Tip Size (in.)	Length (in.)
FL411R	5	3/16	8 7/8
FL412R	7	9/32	8 7/8
FL413R	10	3/8	8 7/8
FL415R	15	5/8	8 7/8
FL416R	20	3/4	8 7/8
FL417R	25	1	8 7/8
FL418R	30	1 3/16	8 7/8



FL420R

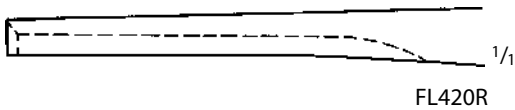

FL420R

Gouge, F/ Removing Broken Screws,
 W/ PEEK Handle

Catalog Number	Tip Size (mm)	Tip Size (in.)	Length (in.)
FL420R	9	3/8	8 7/8



FL423R

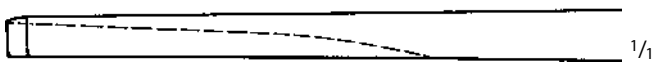

1/1



1/1



1/1

FL423R

LEXER Spongiosa Gouge W/ PEEK
 Handle

Catalog Number	Tip Size (mm)	Tip Size (in.)	Length (in.)
FL423R	10	3/8	11



FL701R-FL702R

ZIELKE Gouge W/ PEEK Handle

Catalog Number	Tip Size (mm)	Tip Size (in.)	Length (in.)
FL701R	5.5	7/32	9
FL702R	9	3/8	9

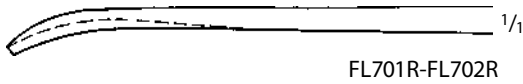

FL701R-FL702R



FL441R-FL445R

Spongiosa Gouge W/ PEEK Handle

Catalog Number	Tip Size (mm)	Tip Size (in.)	Blade	Length (in.)
FL441R	5	3/16	CVD	9 3/4
FL443R	10	3/8	CVD	9 3/4
FL445R	15	5/8	CVD	9 3/4

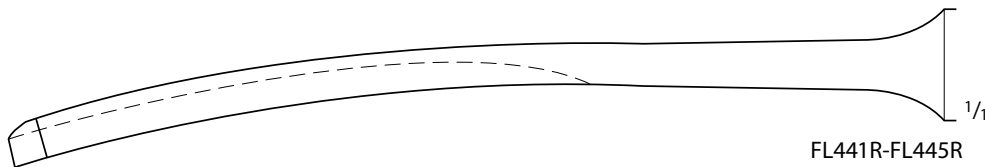

FL441R-FL445R



FL573R-FL577R

STILLE Gouge

Catalog Number	Tip Size (mm)	Tip Size (in.)	Length (in.)
FL573R	10	3/8	8
FL574R	12	1/2	8
FL575R	15	5/8	8
FL576R	20	3/4	8
FL577R	25	1	8

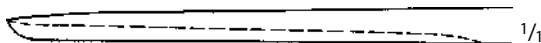

FL573R-FL577R

WAGNER Gouge W/ PEEK Handle

Catalog Number	Tip Size (mm)	Tip Size (in.)	Blade Shape	Length (in.)
ND120R	9	3/8	ANG FWD	13 3/8
ND121R	9	3/8	ANG BACK	13 3/8
ND122R	15	5/8	ANG FWD	13 3/8
ND123R	15	5/8	ANG BACK	13 3/8
ND124R	9	3/8	STR	13 3/8
ND125R	15	5/8	STR	13 3/8



ND120R-ND125R

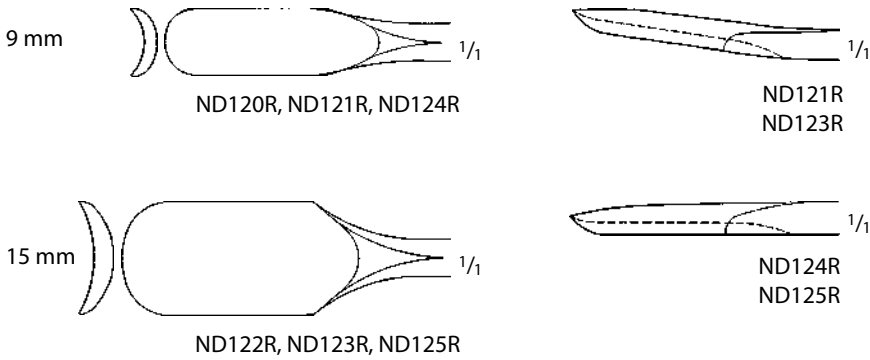

MF465R-MF478R

SMITH-PETERSON Gouge

Catalog Number	Tip	Tip Size (mm)	Length (in.)
MF465R	STR	6	8
MF466R	STR	10	8
MF467R	STR	13	8
MF468R	STR	16	8
MF469R	STR	19	8
MF470R	STR	25	8
MF471R	STR	32	8
MF472R	CVD	6	8
MF473R	CVD	10	8
MF474R	CVD	13	8
MF475R	CVD	16	8
MF476R	CVD	19	8
MF477R	CVD	25	8
MF478R	CVD	32	8

Let Us know if you could not find what you are looking for



FL380R-FL384R



FL380R-FL384R

LEXER-MINI Osteotome W/ PEEK Handle

Catalog Number	Tip Size (mm)	Tip Size (in.)	Length (in.)
FL380R	4	5/32	7
FL381R	6	1/4	7
FL382R	8	5/16	7
FL383R	10	3/8	7
FL384R	12	1/2	7



FL401R-FL408R

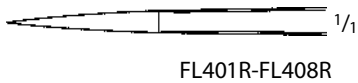

FL401R-FL408R

LEXER Osteotome W/ PEEK Handle

Catalog Number	Tip Size (mm)	Tip Size (in.)	Length (in.)
FL401R	5	3/16	8 7/8
FL402R	7	9/32	8 7/8
FL403R	10	3/8	8 7/8
FL405R	15	5/8	8 7/8
FL406R	20	3/4	8 7/8
FL407R	25	1	8 7/8
FL408R	30	1 3/16	8 7/8
ND108R	10	3/8	10 3/4
ND109R	15	5/8	10 3/4



ND108R-ND109R



ND108R-ND109R

Chisel W/ PEEK Handle

Catalog Number	Tip Size (mm)	Tip Size (in.)	Length (in.)
ND105R	16	5/8	10 1/2



ND105R

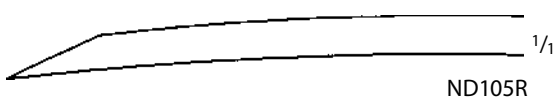

ND105R

COBB Gouge

Catalog Number	Blade	Length (in.)
MB707R	STR	11 1/2



MB707R



MB707R

Gouge, Double Curved,
 W/ HARTPRESS Handle

Catalog Number	Tip Size (mm)	Tip Size (in.)	Length (in.)
ND118R	25	1	11 1/4



ND118R



MB709R-MB715R



MB716R-MB723R

HIBBS Gouge

Catalog Number	Tip Size (mm)	Tip Size (in.)	Blade	Length (in.)
MB709R	16	5/8	STR	9 1/2
MB710R	19	3/4	STR	9 1/2
MB711R	22	7/8	STR	9 1/2
MB712R	25	1	STR	9 1/2
MB713R	28	1 1/8	STR	9 1/2
MB714R	32	1 1/4	STR	9 1/2
MB715R	38	1 1/2	STR	9 1/2
MB716R	6	1/4	CVD	9 1/2
MB717R	9	3/8	CVD	9 1/2
MB718R	13	1/2	CVD	9 1/2
MB719R	13	5/8	CVD	9 1/2
MB720R	19	3/4	CVD	9 1/2
MB721R	25	1	CVD	9 1/2
MB722R	28	1 1/8	CVD	9 1/2
MB723R	38	1 1/2	CVD	9 1/2



FL156R-FL170R



FL156R-FL160R



FL166R-FL170R



FL512R-FL517R

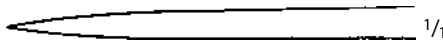

FL512R-FL517R



FL523R-FL527R

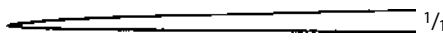

FL523R-FL527R



FL553R-FL557R



FL553R-FL557R

HOKE Osteotome

Catalog Number	Tip Size (mm)	Tip Size (in.)	Blade	Length (in.)
FL156R	3	1/8	STR	6 1/8
FL157R	6	1/4	STR	6 1/8
FL158R	10	3/8	STR	6 1/8
FL159R	13	1/2	STR	6 1/8
FL160R	16	5/8	STR	6 1/8
FL166R	3	1/8	CVD	6 1/8
FL167R	6	1/4	CVD	6 1/8
FL168R	10	3/8	CVD	6 1/8
FL169R	13	1/2	CVD	6 1/8
FL170R	16	5/8	CVD	6 1/8

STILLE Osteotome

Catalog Number	Tip Size (mm)	Tip Size (in.)	Blade	Length (in.)
FL512R	8	5/16	STR, HVY	8
FL513R	10	3/8	STR, HVY	8
FL514R	12	1/2	STR, HVY	8
FL515R	15	5/8	STR, HVY	8
FL516R	20	3/4	STR, HVY	8
FL517R	25	1	STR, HVY	8
FL523R	10	3/8	STR	8
FL524R	12	1/2	STR	8
FL525R	15	5/8	STR	8
FL526R	20	3/4	STR	8
FL527R	25	1	STR	8
FL553R	10	3/8	CVD	8
FL554R	12	1/2	CVD	8
FL555R	15	5/8	CVD	8
FL556R	20	3/4	CVD	8
FL557R	25	1	CVD	8

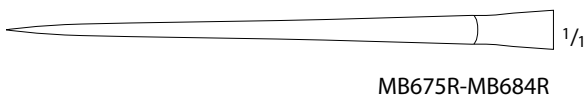
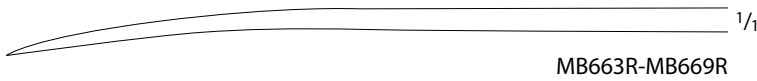
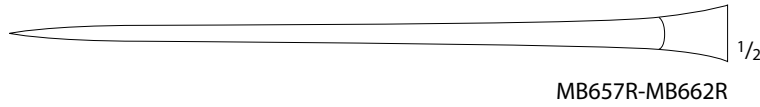
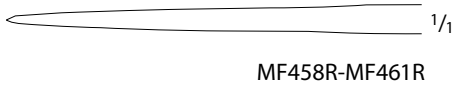

Gouge

Catalog Number	Tip Size (mm)	Tip	Length (in.)
MF458R	4	CVD	7
MF459R	4	STR	7
MF460R	6	CVD	7 1/2
MF461R	6	STR	7 1/2

SMITH-PETERSON Osteotome

Catalog Number	Tip Size (mm)	Tip Size (in.)	Blade	Length (in.)
MB657R	7	9/32	STR	8
MB658R	11	7/16	STR	8
MB659R	14	9/16	STR	8
MB660R	17	21/32	STR	8
MB661R	19	3/4	STR	8
MB662R	25	1	STR	8
MB663R	6	1/4	CVD	8
MB664R	9.5	3/8	CVD	8
MB665R	13	1/2	CVD	8
MB666R	16	5/8	CVD	8
MB667R	19	3/4	CVD	8
MB668R	25	1	CVD	8
MB669R	32	1 1/4	CVD	8

HIBBS Osteotome

Catalog Number	Tip Size (mm)	Tip Size (in.)	Blade	Length (in.)
MB675R	6	1/4	STR	9 5/8
MB676R	10	3/8	STR	9 5/8
MB677R	13	1/2	STR	9 5/8
MB678R	16	5/8	STR	9 5/8
MB679R	19	3/4	STR	9 5/8
MB680R	22	7/8	STR	9 5/8
MB681R	25	1	STR	9 5/8
MB682R	28	1 1/8	STR	9 5/8
MB683R	32	1 1/4	STR	9 5/8
MB684R	38	1 1/2	STR	9 5/8
MB685R	6	1/4	CVD	9 5/8
MB686R	10	3/8	CVD	9 5/8
MB687R	13	1/2	CVD	9 5/8
MB688R	16	5/8	CVD	9 5/8
MB689R	19	3/4	CVD	9 5/8
MB690R	22	7/8	CVD	9 5/8
MB691R	25	1	CVD	9 5/8
MB692R	28	1 1/8	CVD	9 5/8
MB693R	32	1 1/4	CVD	9 5/8
MB694R	38	1 1/2	CVD	9 5/8

COBB Osteotomes

Catalog Number	Tip Size (mm)	Blade	Length (in.)
MB084R	6	STR	11
MB085R	10	STR	11
MB742R	13	STR	11
MB087R	13	STR	11
MB088R	16	STR	11
MB089R	19	STR	11
MB090R	25	STR	11
MG030R	6	CVD	11
MG031R	10	CVD	11
MG032R	13	CVD	11
MG033R	16	CVD	11
MG036R	19	CVD	11
MG034R	25	CVD	11
MG035R	32	CVD	11

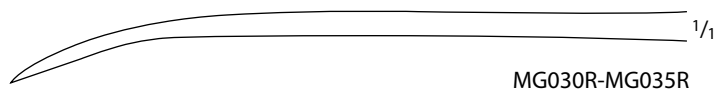
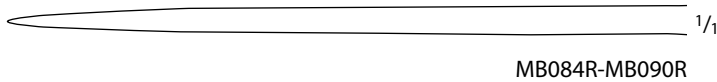



MB404R-MB373R



MB404R-MB373R



MB398R-MB403R



MB398R-MB403R



MB388R-MB389R

Osteotome W/ Hexagonal Handle

Catalog Number	Tip Size (mm)	Length (in.)
MB404R	2	6 1/4
MB405R	3	6 1/4
MB406R	4	6 1/4
MB407R	5	6 1/4
MB408R	6	6 1/4
MB409R	7	6 1/4
MB410R	8	6 1/4
MB411R	9	6 1/4
MB412R	10	6 1/4
MB413R	11	6 1/4
MB373R	12	6 1/4

CONVERSE Osteotome

Catalog Number	Tip Size (mm)	Length (in.)
MB398R	2	7
MB399R	4	7
MB400R	6	7
MB401R	8	7
MB402R	10	7
MB403R	12	7

RUBIN Osteotome, W/ Finger Grip

Catalog Number	Tip Size (mm)	Length (in.)
MB388R	10	6 1/2
MB389R	14	6 1/2



FL088R-MG049R

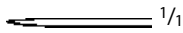

FL088R-MG049R



MG037R-MG044R

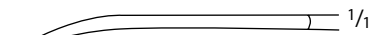

MG037R-MG044R



MB621R-MB628R

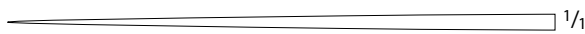

MB620R-MB628R

LAMBOTTE Osteotome

Catalog Number	Tip Size (mm)	Blade	Length (in.)
MG050R	SET OF 7	STR	-
FL088R	2	STR	5
FL101R	4	STR	5
FL102R	6	STR	5
FL104R	8	STR	5
FL106R	10	STR	5
FL108R	12	STR	5
MG046R	14	STR	5
FL109R	15	STR	5
MG047R	18	STR	5
MG048R	19	STR	5
MG049R	20	STR	5
MG037R	2	CVD	5
MG038R	4	CVD	5
MG039R	6	CVD	5
MG040R	8	CVD	5
MG041R	10	CVD	5
MG042R	12	CVD	5
MG043R	14	CVD	5
MG044R	15	CVD	5

LAMBOTTE MINI OSTEOTOME SET:
 CONTAINS SEVEN MG050R STRAIGHT 5"
 OSTEOTOMES:
 2MM, 4MM, 6MM, 8MM, 10MM, 12MM,
 14MM PLUS MALLET (FL036R)

LAMBOTTE Osteotome with
 Calibrations

Catalog Number	Tip Size (mm)	Blade	Length (in.)
MB620R	COMPLETE SET	-	-
MB621R	4	STR	7 1/4
MB622R	6	STR	7 1/4
MB623R	7	STR	7 1/4
MB624R	8	STR	7 1/4
MB625R	10	STR	7 1/4
MB626R	12	STR	7 1/4
MB627R	16	STR	7 1/4
MB628R	22	STR	7 1/4

MB620R includes:
 Osteotome MB621R-MB628R and
 Mallet MB629R



MB640R-MB646R

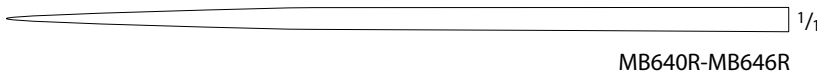

MB640R-MB646R



MB650R-MB656R

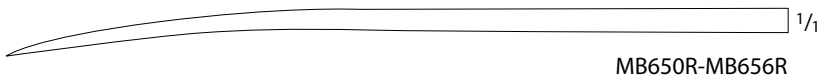

MB650R-MB656R

LAMBOTTE Osteotome

Catalog Number	Tip Size (mm)	Tip Size (in.)	Blade	Length (in.)
MB640R	COMPLETE SET		STR	
MB641R	6	1/4	STR	9
MB642R	13	1/2	STR	9
MB643R	19	3/4	STR	9
MB644R	25	1	STR	9
MB645R	32	1 1/4	STR	9
MB646R	38	1 1/2	STR	9
MB650R	COMPLETE SET		CVD	
MB651R	6	1/4	CVD	9
MB652R	13	1/2	CVD	9
MB653R	19	3/4	CVD	9
MB654R	25	1	CVD	9
MB655R	32	1 1/4	CVD	9
MB656R	38	1 1/2	CVD	9

LAMBOTTE Osteotome

Catalog Number	Tip Size (mm)	Blade	Length (in.)
FL650R	4	STR	9 5/8
FL651R	8	STR	9 5/8
FL652R	10	STR	9 5/8
FL653R	13	STR	9 5/8
FL654R	15	STR	9 5/8
FL655R	18	STR	9 5/8
FL656R	20	STR	9 5/8
FL658R	25	STR	9 5/8
FL659R	30	STR	9 5/8
FL660R	38	STR	9 5/8
FL661R	44	STR	9 5/8
FL662R	50	STR	9 5/8
FL781R	8	CVD	9 5/8
FL783R	13	CVD	9 5/8
FL785R	18	CVD	9 5/8
FL788R	25	CVD	9 5/8
FL789R	30	CVD	9 5/8
FL790R	38	CVD	9 5/8



FL650R-FL662R

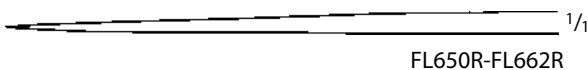

FL650R-FL662R



FL781R-FL790R



FL781R-FL790R

Mallet, PEEK

Catalog Number	Handle	Weight (gr)	Diameter (mm)	Length (in.)
FL010	HARTPRESS	230	42	9 3/4
FL011	HARTPRESS	315	50	9 3/4



FL010-FL011

MEAD Mallet, Removable Discs, 180gr

Catalog Number	Description	Diameter (mm)	Length (in.)
FL035R	COMPLETE	20	7 1/2
FL034	SPARE DISCS, F/FL035R, 2/SET	20	

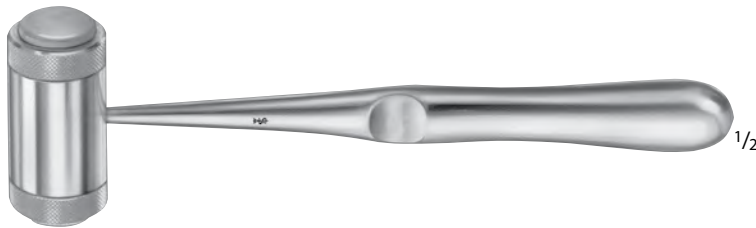

FL035R

Mallet W/ Removable Nylon Discs, 135gr

Catalog Number	Description	Diameter (mm)	Length (in.)
FL036R	COMPLETE	25	7 1/4
FL037	NYLON SPARE DISCS, F/FL036R, 2/SET	25	

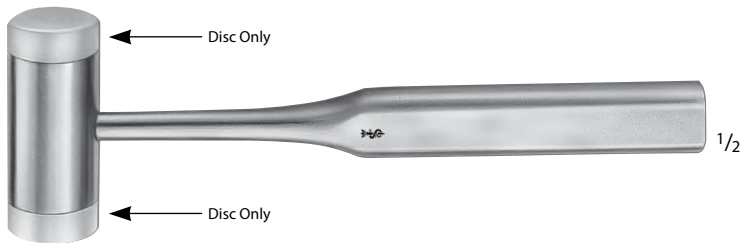

FL036R

Mallet, 226gr

Catalog Number	Description	Diameter (mm)	Length (in.)
MB629R	ONE SIDE NYLON, ONE SIDE METAL	26	7 1/4
MB629200	REPLACEMENT NYLON DISC FOR MB629R Mallet HEAD		



MB629R



DF114R

Mallet, 155gr

Catalog Number	Diameter (mm)	Length (in.)
DF114R	25	7 1/2



US142

Mallet, Copper

Catalog Number	Diameter (mm)	Length (in.)
US142	20	6 1/2



MG583R

KIRK Mallet, 560gr

Catalog Number	Diameter (mm)	Length (in.)
MG583R	35	7 1/4



FL038R

COTTLE Mallet, Flat/Round, 235gr

Catalog Number	Diameter (mm)	Length (in.)
FL038R	30	7 1/4



FL044R

HAJEK Mallet, 140gr

Catalog Number	Diameter (mm)	Length (in.)
FL044R	27	8 3/4



FL055R

BERGMANN Mallet, 260gr

Catalog Number	Diameter (mm)	Length (in.)
FL055R	30	9 1/4

PEEK

Mallet, 285gr, W/ Silicone Handle

Catalog Number	Diameter (mm)	Length (in.)
FL059R	30 / 42	9 1/2



BERGMANN Mallet, 300gr, W/ Silicone Handle

Catalog Number	Diameter (mm)	Length (in.)
FL060R	45	9 5/8



Orthopedic Mallet

Catalog Number	Diameter (mm)	Length (in.)
MB630R	30	7 1/4
MB631R	38	7 1/4

MB630R: 1 LB Weight (485gr)
MB631R: 2 LB Weight (907gr)



**WAGNER Mallet Set, 130gr,
W/ Silicone Handle**

Catalog Number	Diameter (mm)	Length (in.)
FL062	35	9 1/4

Set includes:
1 PR Metal Discs FL064R
1 PR Plastic Discs FL065
1 Wrench FL062/206



FL062



215 gr
1 Metal Disc, flat
1 Metal Disc, convex



FL064R

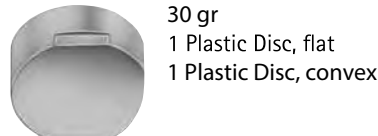

30 gr
1 Plastic Disc, flat
1 Plastic Disc, convex



FL065

**OMBREDANNE Mallet, 520gr,
W/ Silicone Handle**

Catalog Number	Diameter (mm)	Length (in.)
FL066R	40	9 1/2



FL066R

**HEATH Copper Head Mallet, 725gr,
W/ Silicone Handle**

Catalog Number	Diameter (mm)	Length (in.)
FL068R	40	9 1/4



FL068R



MG095R

HEATH Mallet, 823gr

Catalog Number	Diameter (mm)	Size	Length (in.)
MG095R	40	1.8 lbs	7 1/4



FL090R

Bone Graft Tamper

Catalog Number	Diameter (mm)	Length (in.)
FL090R	12	7 7/8



FL090R

Bone Tamp

Catalog Number	Diameter (mm)	Length (in.)
MB796R	2	6 1/4
MB798R	4	6 1/4
MB800R	6	6 1/4
MB801R	8	6 1/4
MB802R	10	6 1/4



MB796R-MB800R



MB796R



MB798R



MB800R



MB801R



MB801R



MB802R

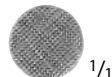

MB802R

SYPERT Spinal Impactor, W/ HART-PRESS Handle

Catalog Number	Tip Size (mm)	Length (in.)
FG093R	3 x 8	11 1/2
FG094R	4 x 10	11 1/2
FG095R	5 x 15	11 1/2
FG096R	6 x 20	11 1/2



FG093R-FG096R



FG093R



FG094R



FG095R



FG096R

COBB Bone Impactor

Catalog Number	Tip Size (mm)	Length (in.)
MB545R	3 x 12	11 1/4



MB545R

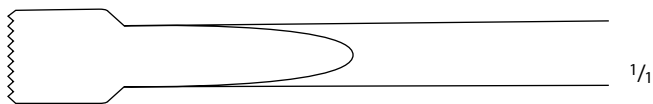

MB545R

RALKS Hand Drill, Cannulated

Catalog Number	Length (in.)
MG021R	6 1/4

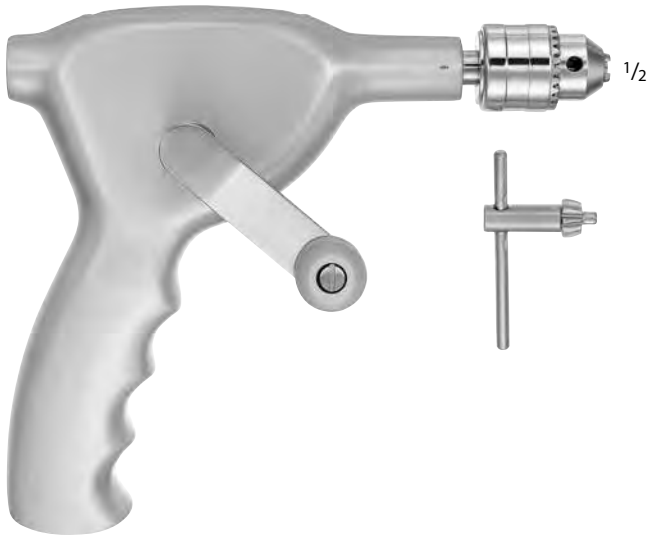

MG021R



FR110R

1/2

CHAMPIONNIÈRE Bone Drill

Catalog Number	Length (in.)
FR110R	6 3/4



FR118R

1/2

Awl/Reamer

Catalog Number	Length (in.)
FR118R	6

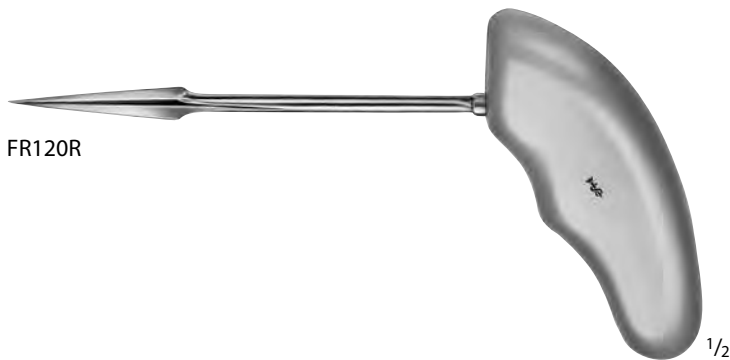

FR120R

1/2

Reamer

Catalog Number	Length (in.)
FR120R	7

PERTHES Reamer

Catalog Number	Length (in.)
FR125R	8 1/2



FR125R

Bone Biopsy Trephine

Catalog Number	Diameter (mm)	Length (in.)
FR140R	3.9 / 5	6 1/4
FR141R	6.4 / 8	6 1/4



FR140R-FR141R



FR140R



FR141R



FK845R

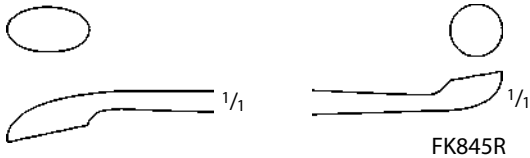

FK845R



FK846R

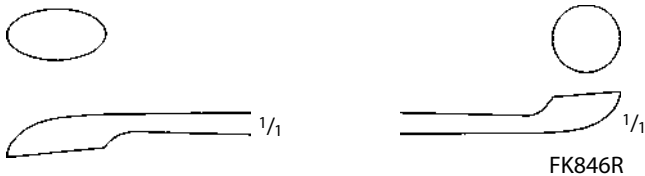

FK846R



FK848R

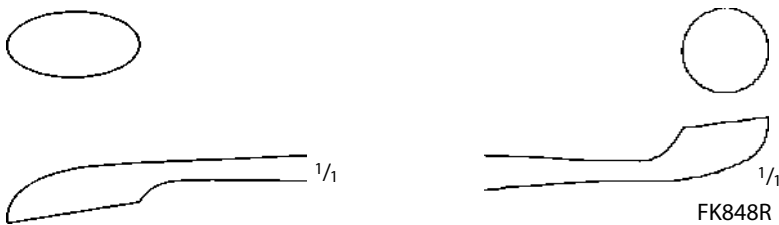

FK848R



FK850R



FK850R



FK658R-FK659R

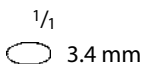

FK658R

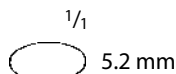

FK659R

Bone Curette, Double Ended

Catalog Number	Tip Size (mm)	Length (in.)
FK845R	6 / 7	5 1/8
FK846R	7 / 8	6 1/4
FK848R	8 / 11	7 7/8
FK850R	7 / 6	8 1/4

WILLIGER Bone Curette

Catalog Number	Tip Size (#)	Tip Size (mm)	Length (in.)
FK658R	00	3.4	6 3/4
FK659R	1	5.2	6 3/4



FK611R-FK617R



$\frac{1}{1}$
 ○ 3 mm
 FK611R

$\frac{1}{1}$
 ○ 4 mm
 FK612R

$\frac{1}{1}$
 ○ 5 mm
 FK613R

$\frac{1}{1}$
 ○ 6 mm
 FK614R

$\frac{1}{1}$
 ○ 8 mm
 FK615R

$\frac{1}{1}$
 ○ 10 mm
 FK616R

$\frac{1}{1}$
 ○ 12 mm
 FK617R



FK621R-FK627R



$\frac{1}{1}$
 ○ 2.5 mm
 FK621R

$\frac{1}{1}$
 ○ 3.4 mm
 FK622R

$\frac{1}{1}$
 ○ 4.2 mm
 FK623R

$\frac{1}{1}$
 ○ 5.2 mm
 FK624R

$\frac{1}{1}$
 ○ 6.3 mm
 FK625R

$\frac{1}{1}$
 ○ 7.4 mm
 FK626R

$\frac{1}{1}$
 ○ 8 mm
 FK627R



FK630R-FK639R

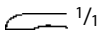

$\frac{1}{1}$
 ○ 2.8 mm
 FK630R

$\frac{1}{1}$
 ○ 3.6 mm
 FK631R

$\frac{1}{1}$
 ○ 4.4 mm
 FK632R

$\frac{1}{1}$
 ○ 5.2 mm
 FK633R

$\frac{1}{1}$
 ○ 6.8 mm
 FK634R

$\frac{1}{1}$
 ○ 8.5 mm
 FK635R

$\frac{1}{1}$
 ○ 10 mm
 FK636R

$\frac{1}{1}$
 ○ 11.5 mm
 FK637R

$\frac{1}{1}$
 ○ 13 mm
 FK638R

$\frac{1}{1}$
 ○ 14.5 mm
 FK639R

BRUNS Curette, Round

Catalog Number	Tip Size (#)	Tip Size (mm)	Length (in.)
FK611R	000	3	6 1/2
FK612R	00	4	6 1/2
FK613R	0	5	6 1/2
FK614R	1	6	6 1/2
FK615R	2	8	6 1/2
FK616R	3	10	6 1/2
FK617R	4	12	6 1/2

SCHEDE Curette

Catalog Number	Tip Size (#)	Tip Size (mm)	Length (in.)
FK621R	000	2.5	6 3/4
FK622R	00	3.4	6 3/4
FK623R	0	4.2	6 3/4
FK624R	1	5.2	6 3/4
FK625R	2	6.3	6 3/4
FK626R	3	7.4	6 3/4
FK627R	4	8.0	6 3/4

VOLKMANN Curette

Catalog Number	Tip Size (#)	Tip Size (mm)	Length (in.)
FK630R	0000	2.8	6 3/4
FK631R	000	3.6	6 3/4
FK632R	00	4.4	6 3/4
FK633R	0	5.2	6 3/4
FK634R	1	6.8	6 3/4
FK635R	2	8.5	6 3/4
FK636R	3	10.0	6 3/4
FK637R	4	11.5	6 3/4
FK638R	5	13.0	6 3/4
FK639R	6	14.5	6 3/4



FK662R-FK665R

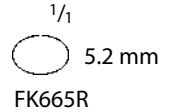
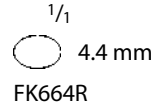
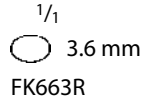
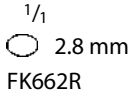
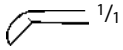

DAUBENSPECK Bone Curette

Catalog Number	Tip Size (#)	Tip Size (mm)	Length (in.)
FK662R	0000	2.8	7 7/8
FK663R	000	3.6	7 7/8
FK664R	00	4.4	7 7/8
FK665R	0	5.2	7 7/8



FK675R-FK679R

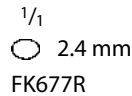
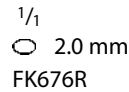
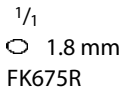
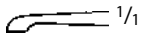

LEMPERT Bone Curette

Catalog Number	Tip Size (mm)	Length (in.)
FK675R	1.8	8 1/2
FK676R	2.0	8 1/2
FK677R	2.4	8 1/2
FK678R	2.6	8 1/2
FK679R	2.8	8 1/2

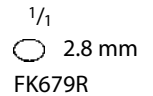
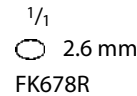

MD565-MD567



EPSTEIN Spinal Curette

Catalog Number	Tip Size (mm)	Size (#)	Length (in.)
MD565	2.0	000	8
MD566	2.5	00	8
MD567	3.0	0	8

SCOVILLE Bone Curette

Catalog Number	Tip Size (#)	Tip Size (mm)	Tip	Length (in.)
FK702R	000	3.6	FWD STR	9 3/4
FK703R	00	4.4	FWD STR	9 3/4
FK704R	0	5.2	FWD STR	9 3/4
FK705R	1	6.8	FWD STR	9 3/4
FK712R	000	3.6	FWD ANG	9 3/4
FK713R	00	4.4	FWD ANG	9 3/4
FK714R	0	5.2	FWD ANG	9 3/4
FK715R	1	6.8	FWD ANG	9 3/4



FK702R-FK715R

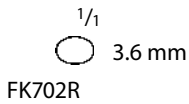
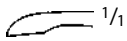

FK702R

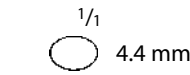
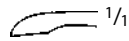

FK703R

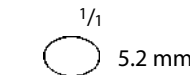
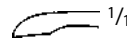

FK704R

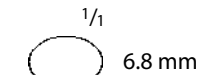
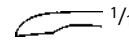

FK705R

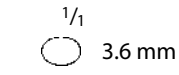

FK712R

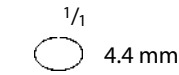

FK713R

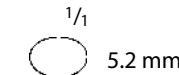

FK714R

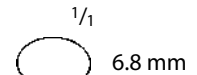
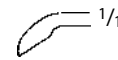

FK715R

BUSHE Bone Curette

Catalog Number	Tip Size (mm)	Tip	Length (in.)
FK723R	3.0	REV ANG	9 3/4
FK724R	4.0	REV ANG	9 3/4
FK725R	5.0	REV ANG	9 3/4



FK723R-FK725R

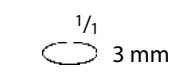
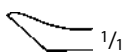

FK723R

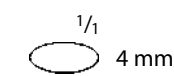
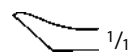

FK724R

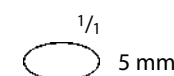
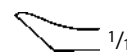

FK725R



MF519R-MD490, MF534R-MF544R, MF567R-MF577R



MF521R-MD481, MF545R-MF555R, MF578R-MF588R



MF523R-MF533R, MF556R-MF566R, MF589R-MF599R



BRUNS Spinal Curette

Catalog Number	Tip Size (#)	Tip	Length (in.)
MF519R	00000	STR	8
MF520R	0000	STR	8
MD482	000	STR	8
MD483	00	STR	8
MD484	0	STR	8
MD485	1	STR	8
MD486	2	STR	8
MD487	3	STR	8
MD488	4	STR	8
MD489	5	STR	8
MD490	6	STR	8
MF521R	00000	FWD ANG	8
MF522R	0000	FWD ANG	8
MD473	000	FWD ANG	8
MD474	00	FWD ANG	8
MD475	0	FWD ANG	8
MD476	1	FWD ANG	8
MD477	2	FWD ANG	8
MD478	3	FWD ANG	8
MD479	4	FWD ANG	8
MD480	5	FWD ANG	8
MD481	6	FWD ANG	8
MF523R	00000	REV ANG	8
MF524R	0000	REV ANG	8
MF525R	000	REV ANG	8
MF526R	00	REV ANG	8
MF527R	0	REV ANG	8
MF528R	1	REV ANG	8
MF529R	2	REV ANG	8
MF530R	3	REV ANG	8
MF531R	4	REV ANG	8
MF532R	5	REV ANG	8
MF533R	6	REV ANG	8

Catalog Number	Tip Size (#)	Tip	Length (in.)
MF534R	00000	STR	9
MF535R	0000	STR	9
MF536R	000	STR	9
MF537R	00	STR	9
MF538R	0	STR	9
MF539R	1	STR	9
MF540R	2	STR	9
MF541R	3	STR	9
MF542R	4	STR	9
MF543R	5	STR	9
MF544R	6	STR	9
MF545R	00000	FWD ANG	9
MF546R	0000	FWD ANG	9
MF547R	000	FWD ANG	9
MF548R	00	FWD ANG	9
MF549R	0	FWD ANG	9
MF550R	1	FWD ANG	9
MF551R	2	FWD ANG	9
MF552R	3	FWD ANG	9
MF553R	4	FWD ANG	9
MF554R	5	FWD ANG	9
MF555R	6	FWD ANG	9
MF556R	00000	REV ANG	9
MF557R	0000	REV ANG	9
MF558R	000	REV ANG	9
MF559R	00	REV ANG	9
MF560R	0	REV ANG	9
MF561R	1	REV ANG	9
MF562R	2	REV ANG	9
MF563R	3	REV ANG	9
MF564R	4	REV ANG	9
MF565R	5	REV ANG	9
MF566R	6	REV ANG	9

Catalog Number	Tip Size (#)	Tip	Length (in.)
MF567R	00000	STR	12
MF568R	0000	STR	12
MF569R	000	STR	12
MF570R	00	STR	12
MF571R	0	STR	12
MF572R	1	STR	12
MF573R	2	STR	12
MF574R	3	STR	12
MF575R	4	STR	12
MF576R	5	STR	12
MF577R	6	STR	12
MF578R	00000	FWD ANG	12
MF579R	0000	FWD ANG	12
MF580R	000	FWD ANG	12
MF581R	00	FWD ANG	12
MF582R	0	FWD ANG	12
MF583R	1	FWD ANG	12
MF584R	2	FWD ANG	12
MF585R	3	FWD ANG	12
MF586R	4	FWD ANG	12
MF587R	5	FWD ANG	12
MF588R	6	FWD ANG	12
MF589R	00000	REV ANG	12
MF590R	0000	REV ANG	12
MF591R	000	REV ANG	12
MF592R	00	REV ANG	12
MF593R	0	REV ANG	12
MF594R	1	REV ANG	12
MF595R	2	REV ANG	12
MF596R	3	REV ANG	12
MF597R	4	REV ANG	12
MF598R	5	REV ANG	12
MF599R	6	REV ANG	12



MB872R-MB880R

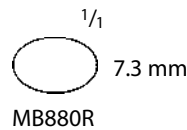
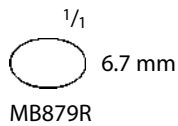
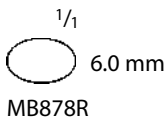
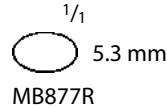
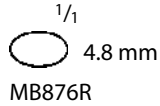
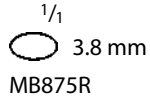
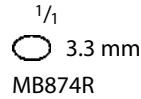
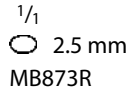
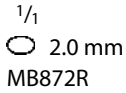

BRUNS Curette

Catalog Number	Tip Size (#)	Tip Size (mm)	Tip	Length (in.)
MB872R	000	2.0	STR	9
MB873R	00	2.5	STR	9
MB874R	0	3.3	STR	9
MB875R	1	3.8	STR	9
MB876R	2	4.8	STR	9
MB877R	3	5.3	STR	9
MB878R	4	6.0	STR	9
MB879R	5	6.7	STR	9
MB880R	6	7.3	STR	9



FK688R-FK690R

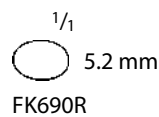
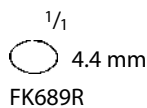
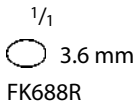
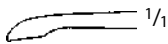

SIMON Bone Curette

Catalog Number	Tip Size (#)	Tip Size (mm)	Length (in.)
FK688R	000	3.6	9 1/4
FK689R	00	4.4	9 1/4
FK690R	0	5.2	9 1/4



MB415R-MB417R



HIBBS Curette

Catalog Number	Tip	Length (in.)
MB415R	SMALL	8
MB416R	MEDIUM	8
MB417R	LARGE	8

Bone Curette, Long, W/ PEEK Handle

Catalog Number	Tip Size (#)	Tip Size (mm)	Length (in.)
FK666R	00	4.4	10 5/8
FK668R	1	6.8	10 5/8
FK670R	2	8.5	10 5/8
FK672R	3	10.0	10 5/8



FK666R-FK672R

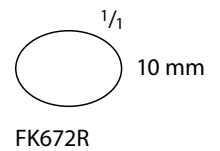
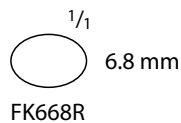
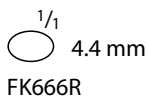
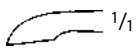

FK773R-FK775R

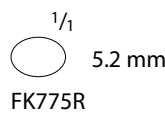
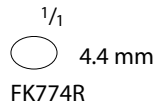
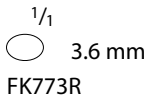

CASPAR Curette, W/ PEEK Handle

Catalog Number	Tip Size (#)	Tip Size (mm)	Blade	Length (in.)
FK773R	000	3.6	STR	8 3/4
FK774R	00	4.4	STR	8 3/4
FK775R	0	5.2	STR	8 3/4
FK783R	000	3.6	CVD	8 3/4
FK784R	00	4.4	CVD	8 3/4
FK785R	0	5.2	CVD	8 3/4



FK783R-FK785R

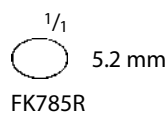
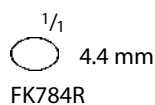
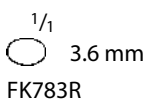
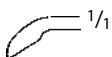

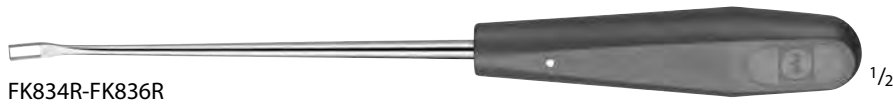



FK834R-FK836R

CASPAR Curette, W/ PEEK Handle

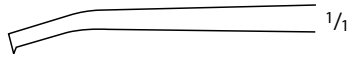
Catalog Number	Tip Size (mm)	Tip	Length (in.)
FK834R	4	SQUARE	8 3/4
FK835R	5	SQUARE	8 3/4
FK836R	6	SQUARE	8 3/4



4 mm  1/1
 FK834R

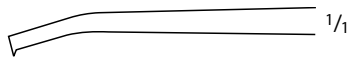

5 mm  1/1
 FK835R

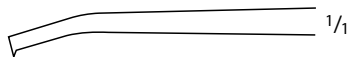

6 mm  1/1
 FK836R

CASPAR Bone Curette, Toothed

Catalog Number	Tip Size (mm)	Tip	Length (in.)
FK854R	4.0	SQUARE	9 3/4
FK855R	5.0	SQUARE	9 3/4



FK854R-FK855R



FK854R



FK855R

CASPAR Bone Curette, Toothed

Catalog Number	Tip Size (mm)	Tip	Length (in.)
FK863R	3.0	SQUARE, ANG	10 5/8
FK864R	4.0	SQUARE, ANG	10 5/8



FK863R-FK864R

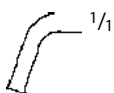

FK863R

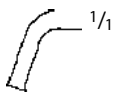

FK864R

COBB Curette

Catalog Number	Tip Size (#)	Tip Size (mm)	Tip	Length (in.)
FK581R	000	2.0	STR	11
FK582R	00	2.5	STR	11
FK583R	0	3.0	STR	11
FK584R	1	3.5	STR	11
FK585R	2	4.5	STR	11
FK586R	3	5.5	STR	11
FK587R	4	7.5	STR	11
FK588R	5	8.5	STR	11
FK589R	6	10.0	STR	11
FK591R	000	2.0	ANG	11
FK592R	00	2.5	ANG	11
FK593R	0	3.0	ANG	11
FK594R	1	3.5	ANG	11
FK595R	2	4.5	ANG	11
FK596R	3	5.5	ANG	11
FK597R	4	7.5	ANG	11
FK598R	5	8.5	ANG	11
FK599R	6	10.0	ANG	11



FK581R-FK589R



FK591R-FK599R

¹/₁
 ○ 2.0 mm
 FK581R, FK591R

¹/₁
 ○ 2.5 mm
 FK582R, FK592R

¹/₁
 ○ 3.0 mm
 FK583R, FK593R

¹/₁
 ○ 3.5 mm
 FK584R, FK594R

¹/₁
 ○ 4.5 mm
 FK585R, FK595R

¹/₁
 ○ 5.5 mm
 FK586R, FK596R

¹/₁
 ○ 7.5 mm
 FK587R, FK597R

¹/₁
 ○ 8.5 mm
 FK588R, FK598R

¹/₁
 ○ 10.0 mm
 FK589R, FK599R

Colored Cervical Curette

Catalog Number	Tip Size (#)	Tip	Color	Length (in.)
MD216R	000000	STR	RED	10
MD217R	00000	STR	SILVER	10
MD218R	0000	STR	PURPLE	10
MD219R	000	STR	TURQUOISE	10
MD220R	00	STR	GOLD	10
MD221R	0	STR	GREEN	10
MD222R	1	STR	ORANGE	10
MD223R	2	STR	BLUE	10
MD224R	3	STR	GRAY	10
MD225R	4	STR	BLACK	10
MD226R	5	STR	BLACK	10
MD227R	6	STR	BLACK	10
MD234R	000000	ANG	RED	10
MD235R	00000	ANG	SILVER	10
MD236R	0000	ANG	PURPLE	10
MD237R	000	ANG	TURQUOISE	10
MD238R	00	ANG	GOLD	10
MD239R	0	ANG	GREEN	10
MD240R	1	ANG	ORANGE	10
MD241R	2	ANG	BLUE	10
MD242R	3	ANG	GRAY	10
MD243R	4	ANG	BLACK	10
MD244R	5	ANG	BLACK	10
MD245R	6	ANG	BLACK	10



Colored Cervical Curette

Catalog Number	Tip Size (#)	Tip	Color	Length (in.)
MD309R	000000	REVERSE ANG	RED	10
MD310R	00000	REVERSE ANG	SILVER	10
MD311R	0000	REVERSE ANG	PURPLE	10
MD312R	000	REVERSE ANG	TURQUOISE	10
MD313R	00	REVERSE ANG	GOLD	10
MD314R	0	REVERSE ANG	GREEN	10
MD315R	1	REVERSE ANG	ORANGE	10
MD316R	2	REVERSE ANG	BLUE	10
MD317R	3	REVERSE ANG	GRAY	10
MD318R	4	REVERSE ANG	BLACK	10
MD319R	5	REVERSE ANG	BLACK	10
MD320R	6	REVERSE ANG	BLACK	10
MD383R	000000	ANG 90°	RED	10
MD384R	00000	ANG 90°	SILVER	10
MD385R	0000	ANG 90°	PURPLE	10
MD386R	000	ANG 90°	TURQUOISE	10
MD387R	00	ANG 90°	GOLD	10
MD388R	0	ANG 90°	GREEN	10
MD389R	1	ANG 90°	ORANGE	10
MD390R	2	ANG 90°	BLUE	10
MD391R	3	ANG 90°	GRAY	10
MD392R	4	ANG 90°	BLACK	10
MD393R	5	ANG 90°	BLACK	10
MD394R	6	ANG 90°	BLACK	10



MD309R-MD320R

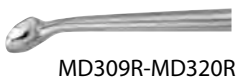

MD309R-MD320R



MD383R-MD394R



MD383R-MD394R

Colored Lumbar Curette

Catalog Number	Tip Size (#)	Tip	Color	Length (in.)
MD500R	000000	STR	RED	13 3/4
MD501R	00000	STR	SILVER	13 3/4
MD502R	0000	STR	PURPLE	13 3/4
MD503R	000	STR	TURQUOISE	13 3/4
MD504R	00	STR	GOLD	13 3/4
MD505R	0	STR	GREEN	13 3/4
MD506R	1	STR	ORANGE	13 3/4
MD507R	2	STR	BLUE	13 3/4
MD508R	3	STR	GRAY	13 3/4
MD509R	4	STR	BLACK	13 3/4
MD510R	5	STR	BLACK	13 3/4
MD511R	6	STR	BLACK	13 3/4
MD620R	000000	ANG	RED	13 3/4
MD621R	00000	ANG	SILVER	13 3/4
MD622R	0000	ANG	PURPLE	13 3/4
MD623R	000	ANG	TURQUOISE	13 3/4
MD624R	00	ANG	GOLD	13 3/4
MD625R	0	ANG	GREEN	13 3/4
MD626R	1	ANG	ORANGE	13 3/4
MD627R	2	ANG	BLUE	13 3/4
MD628R	3	ANG	GRAY	13 3/4
MD629R	4	ANG	BLACK	13 3/4
MD630R	5	ANG	BLACK	13 3/4
MD631R	6	ANG	BLACK	13 3/4
MD632R	000000	REVERSE ANG	RED	13 3/4
MD633R	00000	REVERSE ANG	SILVER	13 3/4
MD634R	0000	REVERSE ANG	PURPLE	13 3/4
MD635R	000	REVERSE ANG	TURQUOISE	13 3/4
MD636R	00	REVERSE ANG	GOLD	13 3/4
MD637R	0	REVERSE ANG	GREEN	13 3/4
MD638R	1	REVERSE ANG	ORANGE	13 3/4
MD639R	2	REVERSE ANG	BLUE	13 3/4
MD640R	3	REVERSE ANG	GRAY	13 3/4
MD641R	4	REVERSE ANG	BLACK	13 3/4
MD642R	5	REVERSE ANG	BLACK	13 3/4
MD643R	6	REVERSE ANG	BLACK	13 3/4

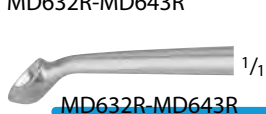
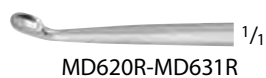

Bayonet Curette

Catalog Number	Tip	Tip Size (#)	Length (in.)
MD660R	STR	0	9
MD661R	STR	00	9
MD662R	STR	000	9
MD663R	STR	0000	9
MD664R	STR	00000	9
MD655R	REVERSE ANG UP	0	9
MD656R	REVERSE ANG UP	00	9
MD657R	REVERSE ANG UP	000	9
MD658R	REVERSE ANG UP	0000	9
MD659R	REVERSE ANG UP	00000	9
MD665R	REVERSE ANG DOWN	0	9
MD666R	REVERSE ANG DOWN	00	9
MD667R	REVERSE ANG DOWN	000	9
MD668R	REVERSE ANG DOWN	0000	9
MD669R	REVERSE ANG DOWN	00000	9



Black Handle Curette

Catalog Number	Tip	Tip Size (#)	Handle	Length (in.)
MN012R	STR	000	8 1/2	13 1/4
MN013R	STR	00	8 1/2	13 1/4
MN014R	STR	0	8 1/2	13 1/4
MN015R	STR	1	8 1/2	13 1/4
MN016R	STR	2	8 1/2	13 1/4
MN017R	STR	3	8 1/2	13 1/4
MN018R	STR	4	8 1/2	13 1/4
MN019R	STR	5	8 1/2	13 1/4
MN020R	STR	6	8 1/2	13 1/4
MN021R	STR	7	8 1/2	13 1/4
MN022R	ANG	000	8 1/2	13 1/4
MN023R	ANG	00	8 1/2	13 1/4
MN024R	ANG	0	8 1/2	13 1/4
MN025R	ANG	1	8 1/2	13 1/4
MN026R	ANG	2	8 1/2	13 1/4
MN027R	ANG	3	8 1/2	13 1/4
MN028R	ANG	4	8 1/2	13 1/4
MN029R	ANG	5	8 1/2	13 1/4
MN030R	ANG	6	8 1/2	13 1/4
MN031R	ANG	7	8 1/2	13 1/4
MN032R	REVERSE ANG	000	8 1/2	13 1/4
MN033R	REVERSE ANG	00	8 1/2	13 1/4
MN034R	REVERSE ANG	0	8 1/2	13 1/4
MN035R	REVERSE ANG	1	8 1/2	13 1/4
MN036R	REVERSE ANG	2	8 1/2	13 1/4
MN037R	REVERSE ANG	3	8 1/2	13 1/4
MN038R	REVERSE ANG	4	8 1/2	13 1/4
MN039R	REVERSE ANG	5	8 1/2	13 1/4
MN040R	REVERSE ANG	6	8 1/2	13 1/4
MN041R	REVERSE ANG	7	8 1/2	13 1/4



XL Black Handled Curette

Catalog Number	Tip	Tip Size (#)	Handle	Length (in.)
MN042R	STR	000	9	15
MN043R	STR	00	9	15
MN044R	STR	0	9	15
MN045R	STR	1	9	15
MN046R	STR	2	9	15
MN047R	STR	3	9	15
MN048R	STR	4	9	15
MN049R	STR	5	9	15
MN050R	STR	6	9	15
MN051R	STR	7	9	15
MN052R	ANG	000	9	15
MN053R	ANG	00	0	15
MN054R	ANG	0	0	15
MN055R	ANG	1	9	15
MN056R	ANG	2	9	15
MN057R	ANG	3	9	15
MN058R	ANG	4	9	15
MN059R	ANG	5	9	15
MN060R	ANG	6	9	15
MN061R	ANG	7	9	15
MN062R	REVERSE ANG	000	9	15
MN063R	REVERSE ANG	00	9	15
MN064R	REVERSE ANG	0	9	15
MN065R	REVERSE ANG	1	9	15
MN066R	REVERSE ANG	2	9	15
MN067R	REVERSE ANG	3	9	15
MN068R	REVERSE ANG	4	9	15
MN069R	REVERSE ANG	5	9	15
MN070R	REVERSE ANG	6	9	15
MN071R	REVERSE ANG	7	9	15



Micro Profile Instruments

Catalog Number	Description	Tip Size (#)	Tip	Length (in.)
MN087R	DISSECTOR	3 MM	STR	10 1/4
MN088R	DISSECTOR	5 MM	STR	10 1/4
MN077R	CURETTE	1	ANG	10 1/4
MN079R	CURETTE	2	ANG	10 1/4
MN081R	CURETTE	3	ANG	10 1/4
MN083R	CURETTE	4	ANG	10 1/4
MN085R	CURETTE	5	ANG	10 1/4
MN078R	CURETTE	1	REV-ANG	10 1/4
MN080R	CURETTE	2	REV-ANG	10 1/4
MN082R	CURETTE	3	REV-ANG	10 1/4
MN084R	CURETTE	4	REV-ANG	10 1/4
MN086R	CURETTE	5	REV-ANG	10 1/4





Tip Size 1:1						
Tip Size (#)	0000	000	00	0	1	2

- BACK STR
- BACK ANG
- BACK DOWN
- FWD STR
- FWD ANG
- FWD DOWN

Microdissectomy Cervical Instruments

Catalog Number	Tip Size (#)	Tip	Length (in.)
MF250	COMPLETE SET (Includes One Each of All Items Listed)		
MF251R	0	FWD STR	8 1/2
MF252R	00	FWD STR	8 1/2
MF253R	000	FWD STR	8 1/2
MF254R	0000	FWD STR	8 1/2
MF255R	Bone Cutter	FWD STR	8 1/2
MF256R	0	FWD ANG	8 1/2
MF257R	00	FWD ANG	8 1/2
MF258R	000	FWD ANG	8 1/2
MF259R	0000	FWD ANG	8 1/2
MF260R	Bone Cutter	FWD ANG	8 1/2
MF261R	0	BACK STR	8 1/2
MF262R	00	BACK STR	8 1/2
MF263R	000	BACK STR	8 1/2
MF264R	0000	BACK STR	8 1/2
MF265R	Bone Cutter	BACK STR	8 1/2
MF266R	0	BACK ANG	8 1/2
MF267R	00	BACK ANG	8 1/2
MF268R	000	BACK ANG	8 1/2
MF269R	0000	BACK ANG	8 1/2
MF270R	Bone Cutter	BACK ANG	8 1/2
MF321R		MICRO NERVE HOOK	8 1/2
MF322R		ULTRA MICRO NERVE HOOK	8 1/2
MF323R		BONE WAXER	8 1/2
MF320	Case - 12 Instruments (Set includes 2 cases)		

Microdissectomy Cervical Long Instruments

Catalog Number	Tip Size (#)	Tip	Length (in.)
MF271	COMPLETE SET (Includes One Each of All Items Listed)		
MF272R	0	FWD STR	9 1/2
MF273R	00	FWD STR	9 1/2
MF274R	000	FWD STR	9 1/2
MF275R	0000	FWD STR	9 1/2
MF276R	Bone Cutter	FWD STR	9 1/2
MF277R	0	FWD ANG	9 1/2
MF278R	00	FWD ANG	9 1/2
MF279R	000	FWD ANG	9 1/2
MF280R	0000	FWD ANG	9 1/2
MF281R	Bone Cutter	FWD ANG	9 1/2
MF282R	0	BACK STR	9 1/2
MF283R	00	BACK STR	9 1/2
MF284R	000	BACK STR	9 1/2
MF285R	0000	BACK STR	9 1/2
MF286R	Bone Cutter	BACK STR	9 1/2
MF287R	0	BACK ANG	9 1/2
MF288R	00	BACK ANG	9 1/2
MF289R	000	BACK ANG	9 1/2
MF290R	0000	BACK ANG	9 1/2
MF291R	Bone Cutter	BACK ANG	9 1/2
MF292R		NERVE HOOK	9 1/2
MF293R		ULTRA MICRO NERVE HOOK	9 1/2
MF294R			9 1/2
MF320	Case - 12 Instruments (Set includes 2 cases)		

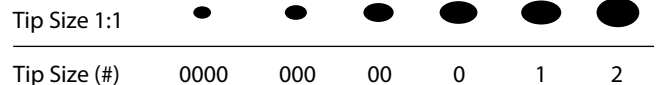
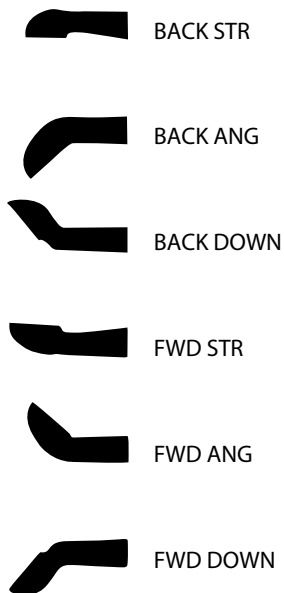

Let Us know if you could not find what you are looking for

Microdiscectomy Lumbar Instruments

Catalog Number	Tip Size (#)	Tip	Length (in.)
MF295	COMPLETE SET (Includes One Each of All Items Listed)		
MF296R	0	FWD STR	9 1/2
MF297R	1	FWD STR	9 1/2
MF298R	2	FWD STR	9 1/2
MF299R	0	FWD ANG	9 1/2
MF300R	1	FWD ANG	9 1/2
MF301R	2	FWD ANG	9 1/2
MF302R	0	FWD DOWN	9 1/2
MF303R	1	FWD DOWN	9 1/2
MF304R	2	FWD DOWN	9 1/2
MF305R	0	BACK STR	9 1/2
MF306R	1	BACK STR	9 1/2
MF307R	2	BACK STR	9 1/2
MF308R	0	BACK ANG	9 1/2
MF309R	1	BACK ANG	9 1/2
MF310R	2	BACK ANG	9 1/2
MF311R	0	BACK DOWN	9 1/2
MF312R	1	BACK DOWN	9 1/2
MF313R	2	BACK DOWN	9 1/2
MF314R		#1 PENFIELD	9 1/2
MF315R		#2 PENFIELD	9 1/2
MF316R		NERVE HOOK	9 1/2
MF317R		#4 PENFIELD	9 1/2
MF318R		BONE WAXER	9 1/2
MF319R		SPINE PROBE	9 1/2
MF320	Case - 12 Instruments (Set includes 2 cases)		

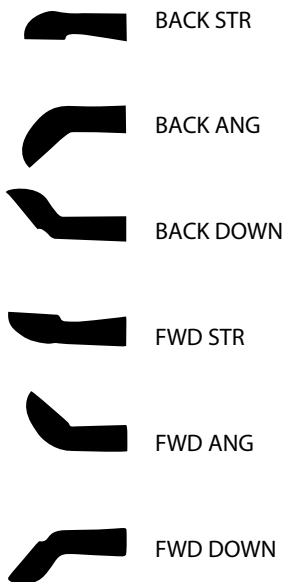

Tip Size 1:1

Tip Size (#)

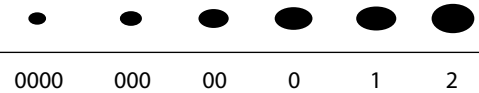

Storage Case for Microdiscectomy
Instruments

Catalog Number
MF320

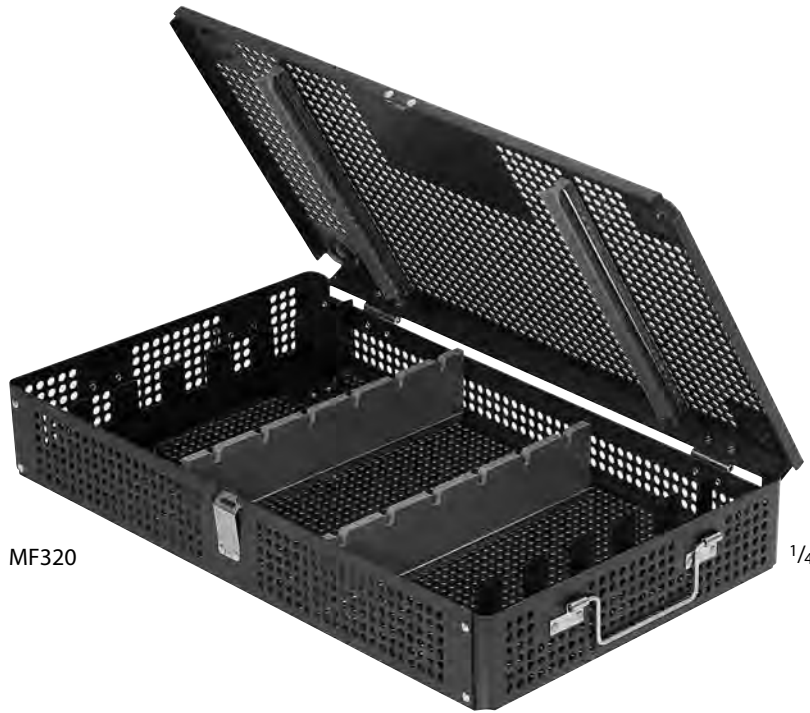

MF320

1/4



FB141R-FB143R



FB141R



FB142R



FB143R



MB456R



MB456R



FK292R-FK293R

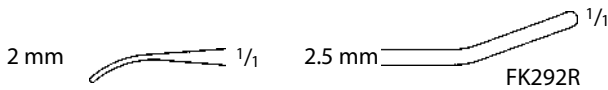

FK292R

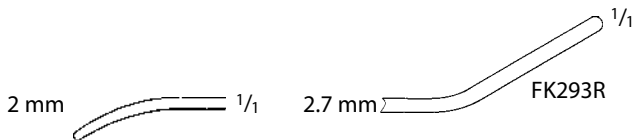

FK293R

LEMMON Intima Dissector

Catalog Number	Tip	Length (in.)
FB141R	SLIGHT-CVD	6 1/2
FB142R	CVD	6 1/2
FB143R	HEAVY-CVD	6 1/2

BUNNELL Dissecting Probe

Catalog Number	Tip	Length (in.)
MB456R	ANG	5 1/2

WATSON-CHEYNE Dissector, Double Ended

Catalog Number	Blade Size (mm)	Length (in.)
FK292R	2 / 2.5	5 1/8
FK293R	2 / 2.7	7 1/2

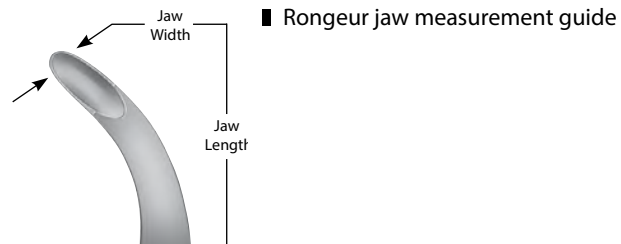

STELLBRINK Synovectomy Rongeur

Catalog Number	Jaw Size (mm)	Jaw	Length (in.)
FO399R	2.0 x 39.5	SLIGHT-CVD	6 7/8
FO400R	2 x 33	CVD	6 3/4

Synovectomy Rongeur

Catalog Number	Jaw Size (mm)	Jaw	Length (in.)
FO599R	1.8 x 24	CVD	5 1/8

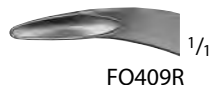
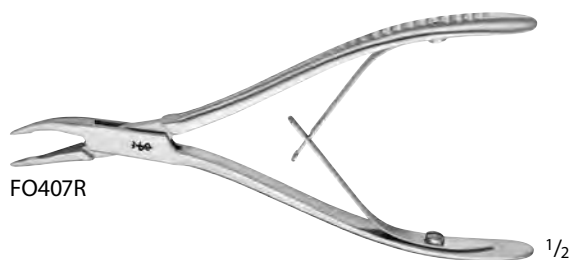

FRIEDMANN Micro Rongeur

Catalog Number	Jaw Size (mm)	Jaw	Length (in.)
FO406R	1.3 x 19	STR	5 1/2
FO407R	1.3 x 20	CVD	5 1/2

LUER-FRIEDMANN Bone Rongeur

Catalog Number	Jaw Size (mm)	Jaw	Length (in.)
FO409R	2.2 x 22	CVD	5 3/4

Bone Rongeur

Catalog Number	Jaw Size (mm)	Jaw	Length (in.)
FO410R	3.8 x 19	CVD	5 1/2

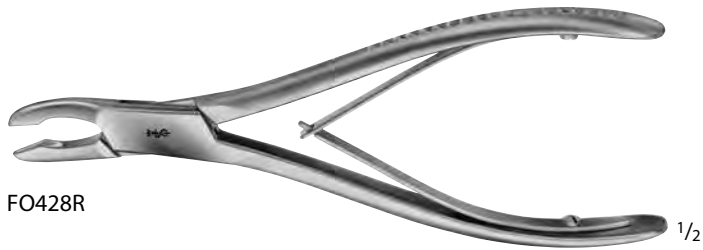

FO428R



FO428R

HAKANSSON Bone Rongeur

Catalog Number	Jaw Size (mm)	Jaw	Length (in.)
FO428R	4.5 x 24	CVD	6 3/4

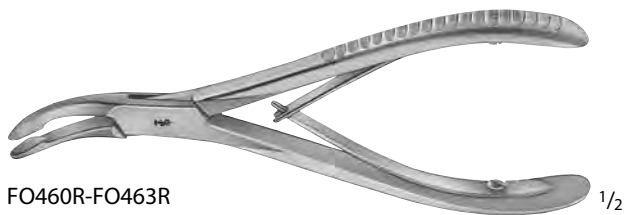

FO460R-FO463R



FO460R



FO462R



FO411R



FO412R



FO461R



FO463R

LUER Bone Rongeur

Catalog Number	Jaw Size (mm)	Jaw	Length (in.)
FO460R	7.5 x 25	STR	6 7/8
FO462R	9.5 x 33	STR	7
FO411R	4.2 x 20	CVD	6
FO412R	4.2 x 26	STRONG CVD	6 1/8
FO461R	7.5 x 24.5	CVD	6 7/8
FO463R	9.0 x 30	CVD	7

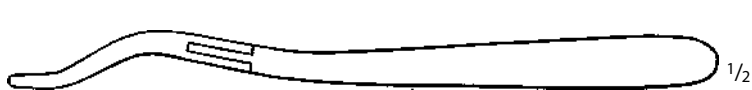

BLUMENTHAL Bone Rongeur

Catalog Number	Jaw Size (mm)	Jaw	Length (in.)
FO415R	3.5 x 25	30° CVD	6 1/8
FO416R	3.5 x 22	45° CVD	6

JANSEN Bone Rongeur

Catalog Number	Jaw Size (mm)	Jaw	Length (in.)
FO430R	4.2 x 35	STR	6 7/8
FO432R	4.5 x 30	CVD	6 7/8
FO442R	3.8 x 37	ANG	7 1/2



ALEXANDER Bone Rongeur

Catalog Number	Jaw Size (mm)	Jaw	Length (in.)
FO440R	3.2 x 27	ANG	5 1/2

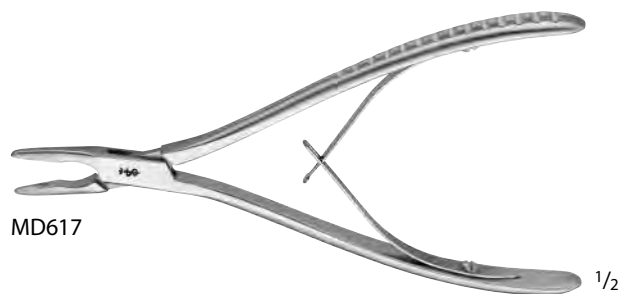

LEMPERT Bone Rongeur

Catalog Number	Jaw Size (mm)	Jaw	Length (in.)
MD617	2.0 x 23	DEL, STR	6 1/2
FO450R	2.2 x 27	STR	7 7/8
MG059R	2.5 x 30	CVD	6 1/4
FO451R	2.2 x 27	CVD	7 7/8



BEYER Bone Rongeur

Catalog Number	Jaw Size (mm)	Jaw	Length (in.)
FO453R	3.2 x 32	CVD	7



MEAD Bone Rongeur

Catalog Number	Jaw Size (mm)	Jaw	Length (in.)
FO455R	3.5 x 30	CVD	6 1/2

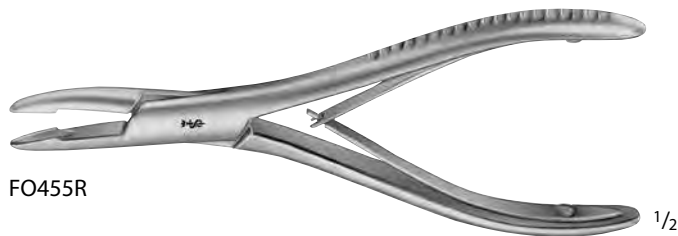

BANE-HARTMANN Bone Rongeur

Catalog Number	Jaw Size (mm)	Jaw	Length (in.)
FO457R	4.0 x 32	CVD	6 7/8



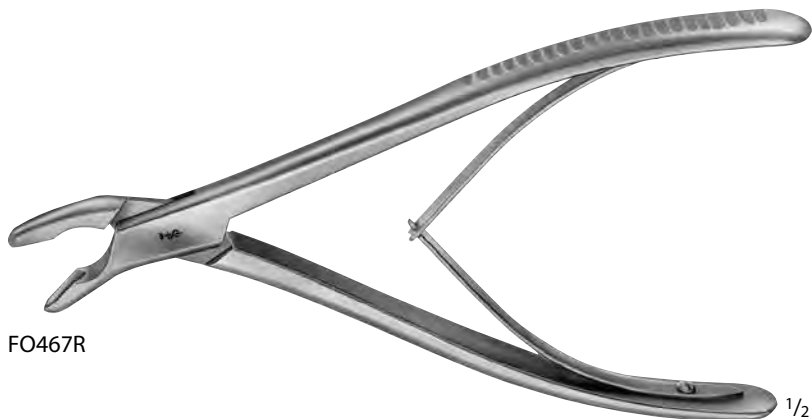

FO467R



FO467R

TROTTER Bone Rongeur

Catalog Number	Jaw Size (mm)	Jaw	Length (in.)
FO467R	6.5 x 24	CVD	8



FO470R



FO470R

OLIVECRONA Bone Rongeur

Catalog Number	Jaw Size (mm)	Jaw	Length (in.)
FO470R	5.0 x 36.5	CVD	8



FO472R



FO472R

GULEKE Bone Rongeur

Catalog Number	Jaw Size (mm)	Jaw	Length (in.)
FO472R	6.5 x 27	CVD	8

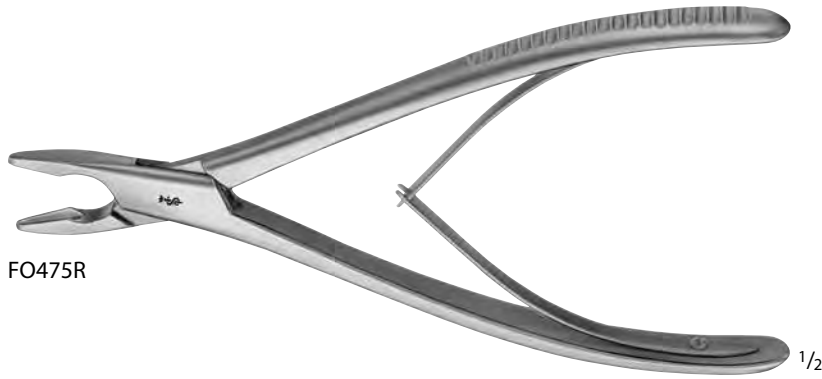

FO475R



FO475R

PENNYBACKER Bone Rongeur

Catalog Number	Jaw Size (mm)	Jaw	Length (in.)
FO475R	4.0 x 26	STR	8

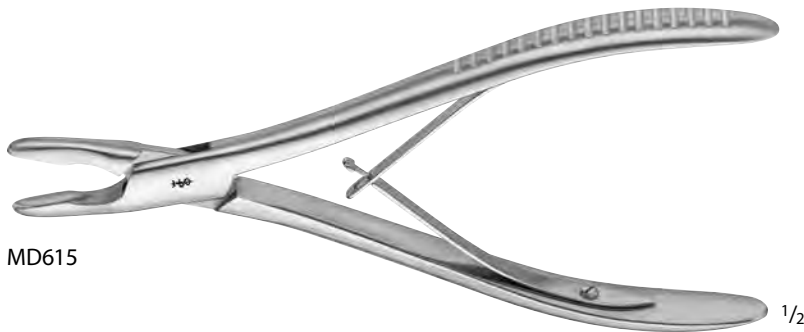

MD615



MD615

ADSON Cranial Rongeur

Catalog Number	Jaw Size (mm)	Jaw	Length (in.)
MD615	21.0 x 31.5	STR	7 7/8



MG060R



MG060R

KLEINERT-KUTZ Rongeur, Double Action

Catalog Number	Jaw Size (mm)	Jaw	Length (in.)
MG060R	3.0 x 15.0	SLIGHT, CVD	6 1/8



FO500R-FO502R



FO500R



FO502R

BOEHLER Bone Rongeur, Double Action

Catalog Number	Jaw Size (mm)	Jaw	Jaw End	Length (in.)
FO500R	3.0 x 27.0	CVD	NARR	6 1/8
FO502R	3.5 x 30.0	CVD	WIDE	6 1/8



FO514R

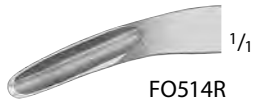

FO514R

BEYER Bone Rongeur, Double Action

Catalog Number	Jaw Size (mm)	Jaw	Length (in.)
FO514R	4.0 x 30.0	CVD	7



FO511R

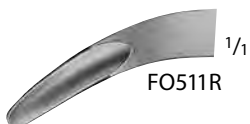

FO511R

MAYFIELD Bone Rongeur, Double Action

Catalog Number	Jaw Size (mm)	Jaw	Length (in.)
FO511R	3.5 x 23	CVD	6 7/8



FO515R



FO515R



MG056R-MG058R

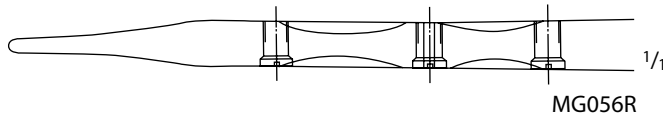

MG056R

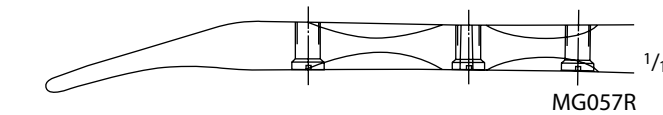

MG057R

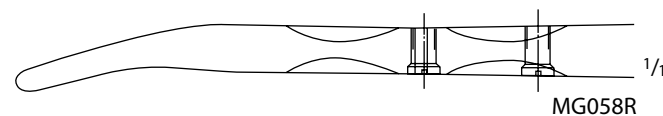

MG058R



MG579R, FO518R

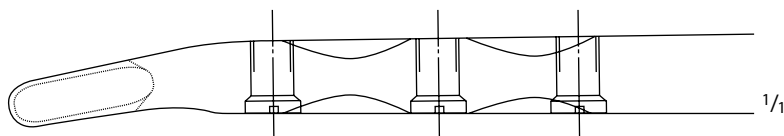

MG579R, FO518R

**ZAUFAL-JANSEN Bone Rongeur,
 Double Action**

Catalog Number	Jaw Size (mm)	Jaw	Length (in.)
FO515R	4.5 x 29.0	CVD	7

RUSKIN Bone Rongeur, Double Action

Catalog Number	Jaw Size (mm)	Jaw	Length (in.)
MG056R	2	STR, MINI	6 1/4
MG057R	2	CVD, MINI	6 1/4
MG058R	3	CVD, MINI	6 1/4
FO518R	5	CVD	7 1/2
MG579R	6	CVD	7 1/4



FO520R

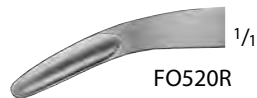

FO520R

MARQUARDT Bone Rongeur, Double Action

Catalog Number	Jaw Size (mm)	Jaw	Length (in.)
FO520R	3.5 x 15.5	CVD	7 7/8

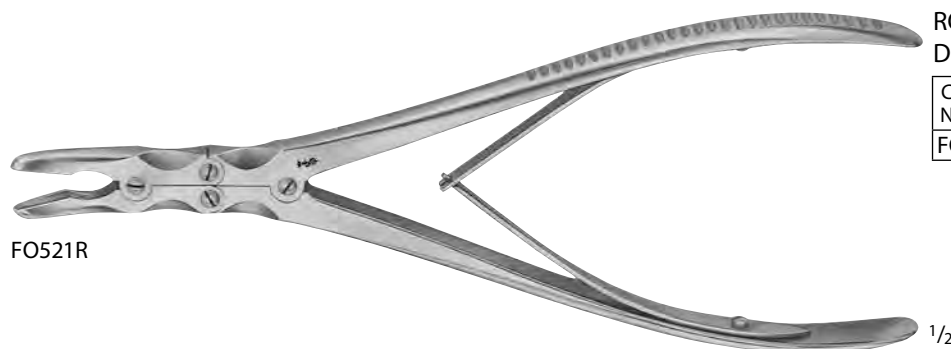

FO521R



FO521R

ROETTGEN-RUSKIN Bone Rongeur, Double Action

Catalog Number	Jaw Size (mm)	Jaw	Length (in.)
FO521R	6.3 x 30	CVD	9 1/2



MG577R



MG577R

SMITH-PETERSON Rongeur

Catalog Number	Jaw Size (mm)	Jaw	Length (in.)
MG577R	3	STR	9 1/2



FO522R-FO523R

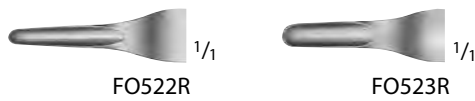

ECHLIN Bone Rongeur, Double Action, Duckbill

Catalog Number	Jaw Size (mm)	Jaw	Length (in.)
FO522R	2 x 10	ANG	9
FO523R	3 x 10	ANG	9



MG581R

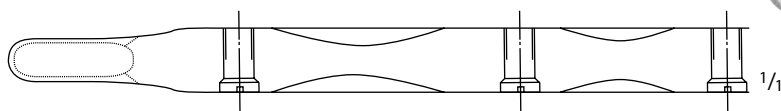

MG581R

LEKSELL Bone Rongeur, Double Action, Duckbill

Catalog Number	Jaw Size (mm)	Jaw	Length (in.)
MG581R	5	FULL CVD	9
FO526R	5 x 16	ANG	9 5/8
FO527R	3 x 16	ANG	9 5/8



FO526R-FO527R

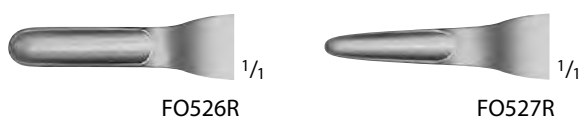



FRYKHOLM Bone Rongeur, Double Action

Catalog Number	Jaw Size (mm)	Jaw	Length (in.)
FO525R	4.5 x 25	ANG	9 1/2

FO525R



FO525R



STILLE Bone Rongeur, Double Action, Duckbill

Catalog Number	Jaw Size (mm)	Jaw	Length (in.)
FO530R	7.0 x 25	ANG	9

FO530R



FO530R



LEKSELL-STILLE Bone Rongeur, Double Action, Duckbill

Catalog Number	Jaw Size (mm)	Jaw	Length (in.)
FO532R	7.5 x 29.5	ANG	9 1/2

FO532R



FO532R

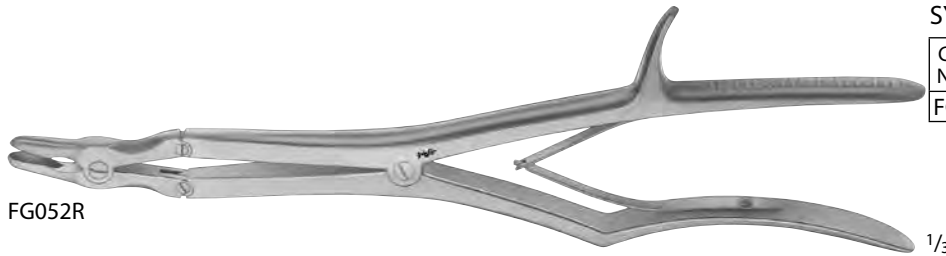

FG052R



SYPERT Bone Rongeur, Double Action

Catalog Number	Jaw Size (mm)	Jaw	Length (in.)
FG052R	8.0 x 35.0	ANG	14 1/4

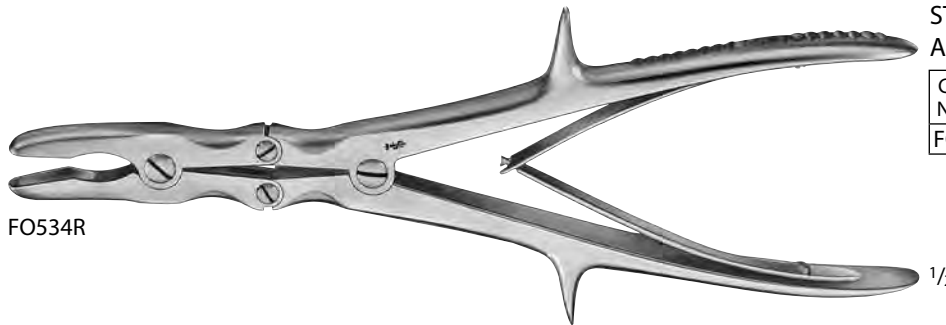

FO534R



STILLE-RUSKIN Bone Rongeur, Double Action

Catalog Number	Jaw Size (mm)	Jaw	Length (in.)
FO534R	8.0 x 34.0	CVD	9 1/2



FO570R-FO572R



SAUERBRUCH-CORYLLOS Rongeur, Double Action

Catalog Number	Length (in.)
FO570R	12 1/4
FO572R	12 1/4



FO550R-FO551R

LUER-STILLE Bone Rongeur, Double Action

Catalog Number	Jaw Size (mm)	Jaw	Length (in.)
FO550R	10.5 x 27.5	STR	8 7/8
FO551R	10 x 26.5	CVD	8 7/8



FO550R



FO551R



FO555R

SEMB Bone Rongeur, Double Action

Catalog Number	Jaw Size (mm)	Jaw	Length (in.)
FO555R	16.5 x 38.5	CVD	9 1/2

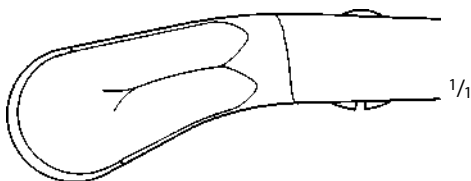

FO555R

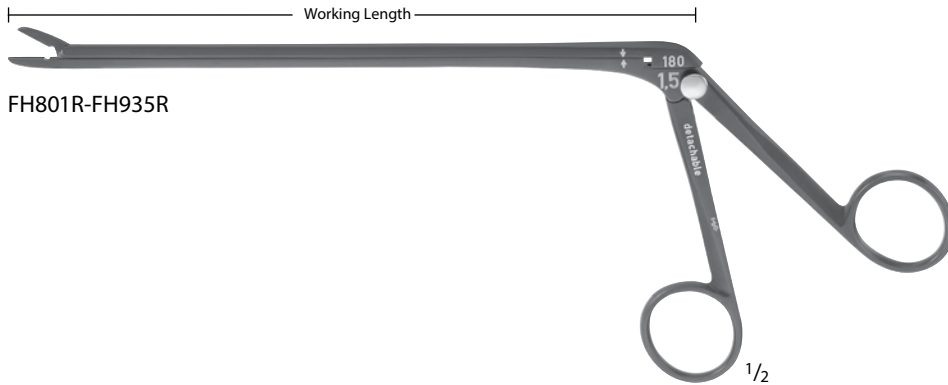

FH801R-FH935R



Noir Detachable Rongeurs

Working Length (in.)	Jaw	Jaw	1.5 mm	2.0 mm	3.0 mm	4.0 mm	5.0 mm
6		STR	FH801B	FH802B	FH803B	FH804B	FH805B
6		UP	FH901B	FH902B	FH903B	FH904B	FH905B
7		STR	FH811B	FH812B	FH813B	FH814B	FH815B
7		UP	FH911B	FH912B	FH913B	FH914B	FH915B
7 7/8		STR	FH821B	FH822B	FH823B	FH824B	FH825B
7 7/8		UP	FH921B	FH922B	FH923B	FH924B	FH925B
9		STR	FH891B	FH892B	FH893B	FH894B	FH895B
9		UP	FH931B	FH932B	FH933B	FH934B	FH935B
11		STR	-	-	FH837B	FH838B	FH839B



FH851R-FH985R



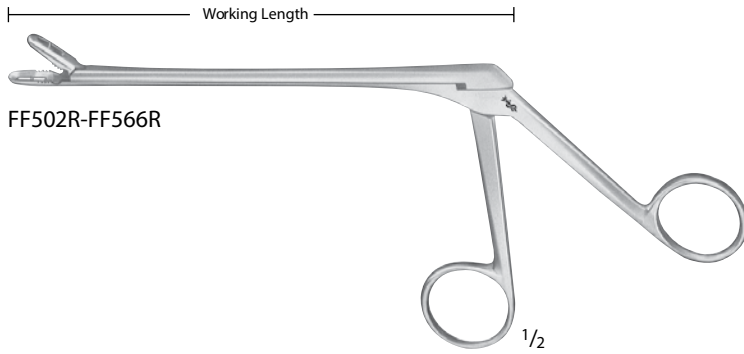

Noir Detachable Rongeur

Working Length (in.)	Jaw	Jaw	1.5 mm	2.0 mm	3.0 mm	4.0 mm	5.0 mm
6		STR	FH851B	FH852B	FH853B	FH854B	FH855B
7		UP	FH951B	FH952B	FH953B	FH954B	FH955B
7		STR	FH861B	FH862B	FH863B	FH864B	FH865B
7		UP	FH961B	FH962B	FH963B	FH964B	FH965B
7 7/8		STR	FH871B	FH872B	FH873B	FH874B	FH875B
7 7/8		UP	FH971B	FH972B	FH973B	FH974B	FH975B
9		STR	FH881B	FH882B	FH883B	FH884B	FH885B
9		UP	FH981B	FH982B	FH983B	FH984B	FH985B
11		STR	-	-	FH847B	FH848B	FH849B



FF502R-FF566R

 1/16
 FF502R, FF532R, FF562R

 1/16
 FF503R, FF533R, FF563R

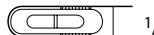
 1/16
 FF504R, FF534R, FF564R

 1/16
 FF535R, FF565R

 1/16
 FF536R, FF566R

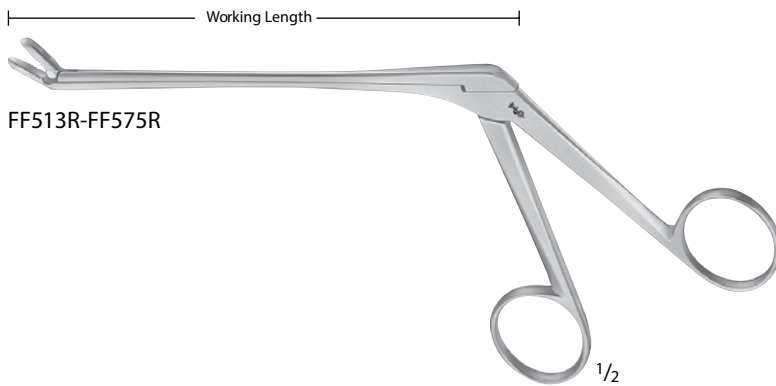

FF513R-FF575R

 1/16
 FF513R, FF543R, FF573R

 1/16
 FF514R, FF544R, FF574R

 1/16
 FF545R, FF575R

CASPAR Rongeur W/ Teeth

Catalog Number	Jaw Size (mm)	Jaw	Working Length (in.)
FF502R	2 x 12	STR	5 1/2
FF532R	2 x 12	STR	6 1/4
FF562R	2 x 12	STR	7 1/4
FF503R	3 x 12	STR	5 1/2
FF533R	3 x 12	STR	6 1/4
FF563R	3 x 12	STR	7 1/4
FF504R	4 x 14	STR	5 1/2
FF534R	4 x 14	STR	6 1/4
FF564R	4 x 14	STR	7 1/4
FF535R	5 x 14	STR	6 1/4
FF565R	5 x 14	STR	7 1/4
FF536R	6 x 16	STR	6 1/4
FF566R	6 x 16	STR	7 1/4
FF513R	3 x 12	UP	5 1/2
FF543R	3 x 12	UP	6 1/4
FF573R	3 x 12	UP	7 1/4
FF514R	4 x 14	UP	5 1/2
FF544R	4 x 14	UP	6 1/4
FF574R	4 x 14	UP	7 1/4
FF545R	5 x 14	UP	6 1/4
FF575R	5 x 14	UP	7 1/4

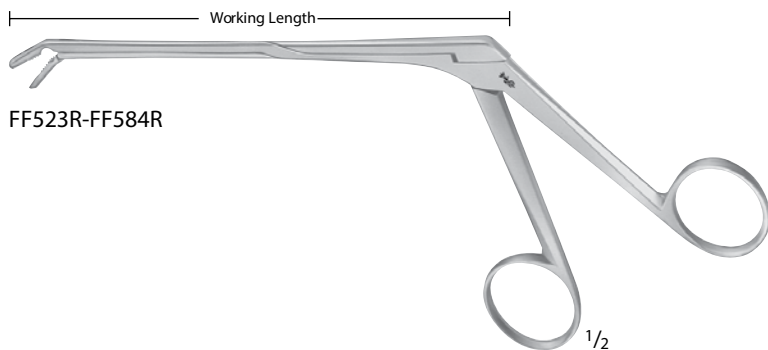

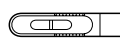
 1/16
 FF523R, FF553R, FF583R

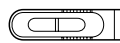
 1/16
 FF524R, FF554R, FF584R

CASPAR Rongeur W/ Teeth (continued)

Catalog Number	Jaw Size (mm)	Jaw	Working Length (in.)
FF523R	3 x 12	DOWN	5 1/2
FF553R	3 x 12	DOWN	6 1/4
FF583R	3 x 12	DOWN	7 1/4
FF524R	4 x 14	DOWN	5 1/2
FF554R	4 x 14	DOWN	6 1/4
FF584R	4 x 14	DOWN	7 1/4

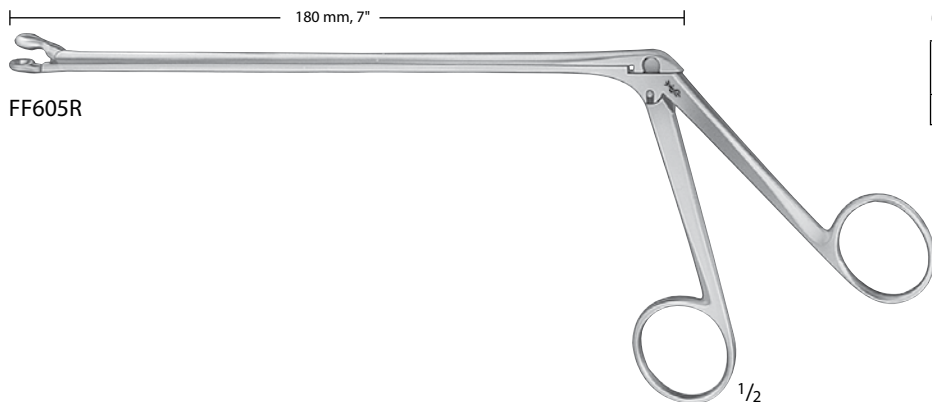

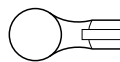
 1/16
 FF605R

OLDBERG Rongeur

Catalog Number	Diameter (mm)	Working Length (in.)
FF605R	7.0	7

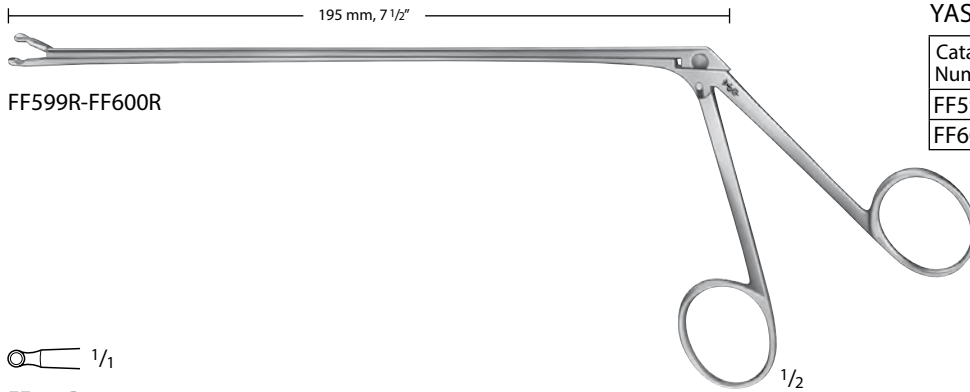

FF599R-FF600R

YASARGIL Rongeur

Catalog Number	Diameter (mm)	Working Length (in.)
FF599R	2.2	7 1/2
FF600R	3.5	7 1/2



FF599R

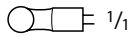

FF600R

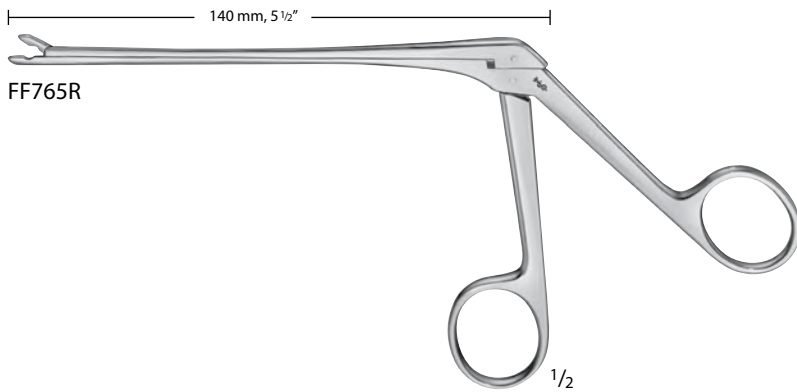

FF765R

BECK Rongeur

Catalog Number	Jaw Size (mm)	Working Length (in.)
FF765R	2 x 10	5 1/8



FF765R

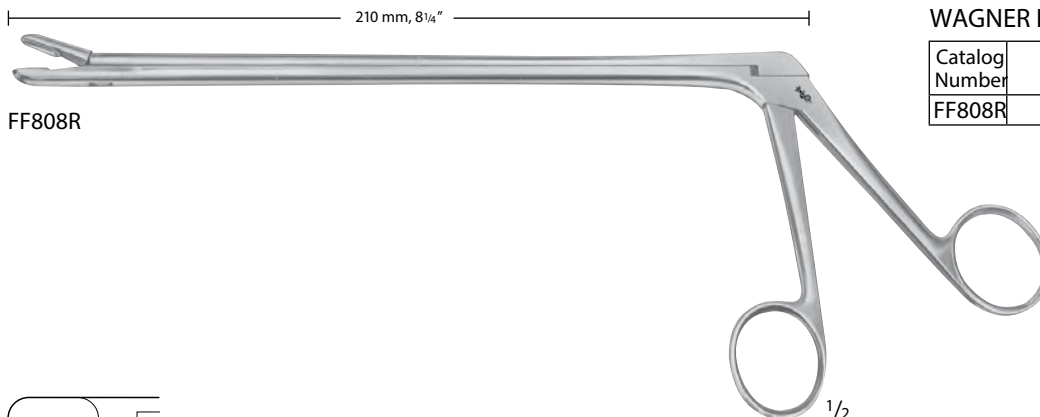

FF808R

WAGNER Rongeur

Catalog Number	Jaw Size (mm)	Working Length (in.)
FF808R	5.5	8 1/4



FF808R

CUSHING Rongeur

Catalog Number	Jaw Size (mm)	Jaw	Style	Working Length (in.)
MD537R	1.5 x 10	STR	STANDARD	7
MN090R	1.5 x 10	STR	DELICATE	9
FF803R	2 x 10	STR	-	7
MN093R	2 x 10	STR	STANDARD	9
MN096R	2 x 10	STR	STANDARD	11
MN099R	2 x 10	STR	STANDARD	12
MD538R	1.5 x 10	UP	STANDARD	7
MD618	2 x 10	UP	-	7
MN091R	1.5 x 10	UP	DELICATE	9
MN094R	2 x 10	UP	STANDARD	9
MN097R	2 x 10	UP	STANDARD	11
MN100R	2 x 10	UP	STANDARD	12
MD539R	1.5 x 10	DOWN	STANDARD	7
MN092R	1.5 x 10	DOWN	DELICATE	9
MD619	2 x 10	DOWN	-	7
MN095R	2 x 10	DOWN	STANDARD	9
MN098R	2 x 10	DOWN	STANDARD	11
MN101R	2 x 10	DOWN	STANDARD	12

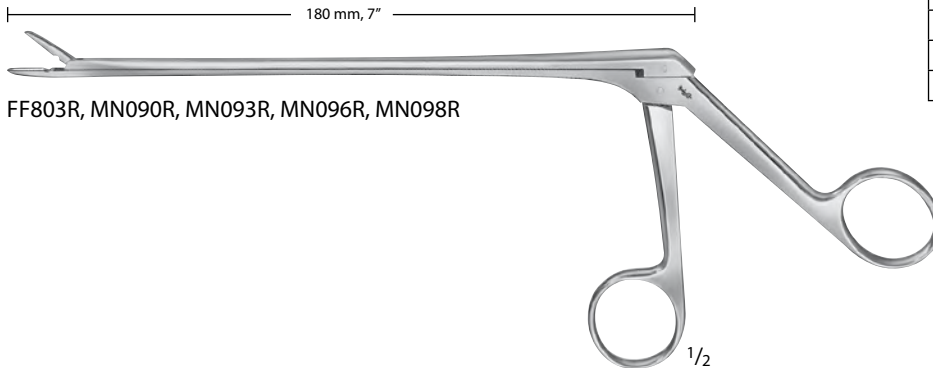

LOVE-GRUENWALD Rongeur

Catalog Number	Jaw Size (mm)	Jaw	Working Length (in.)
FF805R	3 x 10	STR	7
MN102R	3 x 10	STR	9
MN105R	3 x 10	STR	11
MN108R	3 x 10	STR	12
MF446R	2 x 10	UP	5
FF806R	3 x 10	UP	7
MN103R	3 x 10	UP	9
MN106R	3 x 10	UP	11
MN109R	3 x 10	UP	12
MF447R	2 x 10	DOWN	5
FF810R	3 x 10	DOWN	7
MN104R	3 x 10	DOWN	9
MN107R	3 x 10	DOWN	11
MN110R	3 x 10	DOWN	12

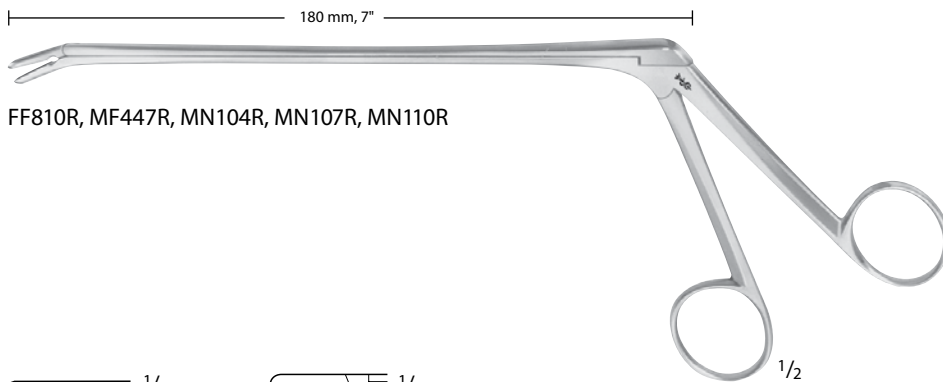
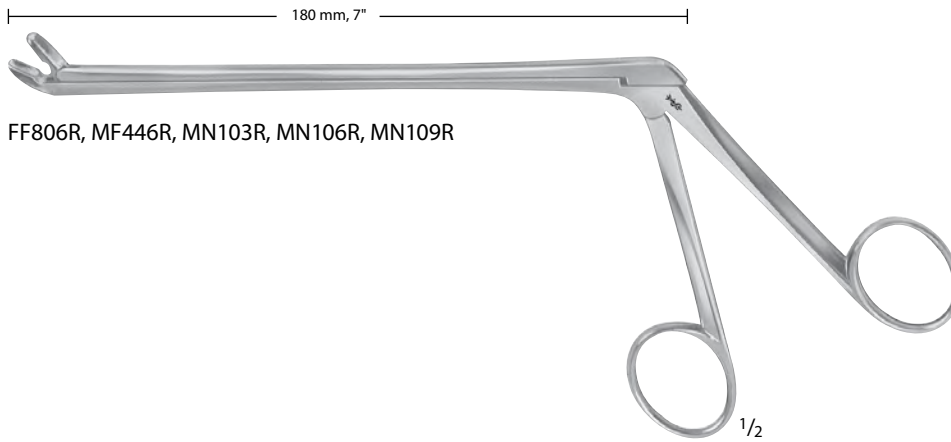
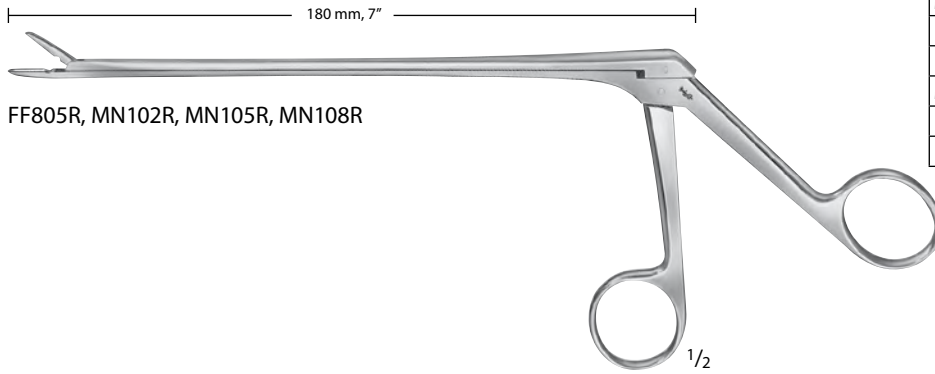

SPURLING Rongeur

Catalog Number	Jaw Size (mm)	Jaw	Working Length (in.)
FF807R	4 x 10	STR	7
MN111R	4 x 10	STR	9
MN114R	4 x 10	STR	11
MN117R	4 x 10	STR	12
FF814R	4 x 10	UP	7
MN112R	4 x 10	UP	9
MN115R	4 x 10	UP	11
MN118R	4 x 10	UP	12
FF811R	4 x 10	DOWN	7
MN113R	4 x 10	DOWN	9
MN116R	4 x 10	DOWN	11
MN119R	4 x 10	DOWN	12

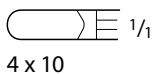
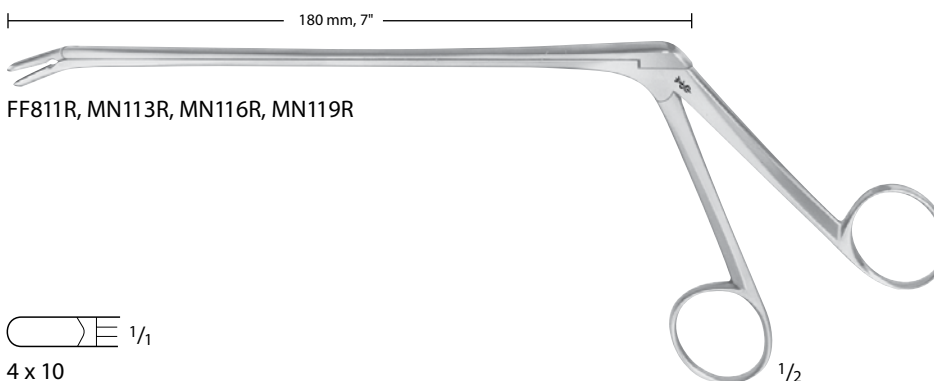
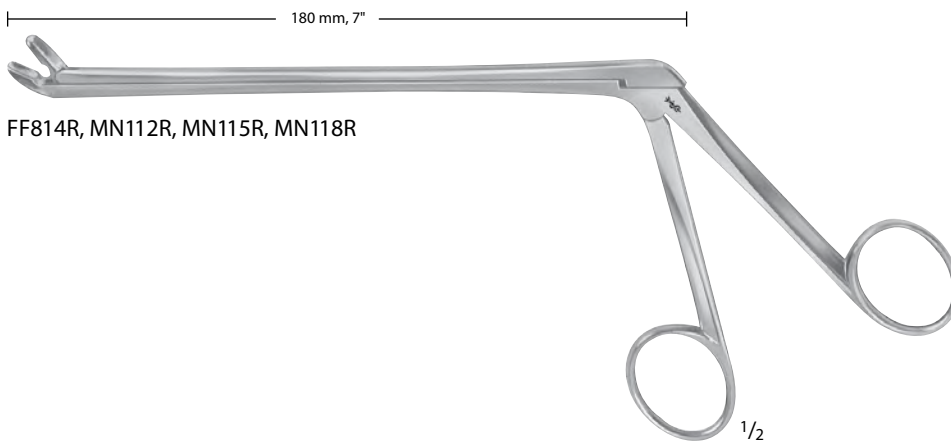
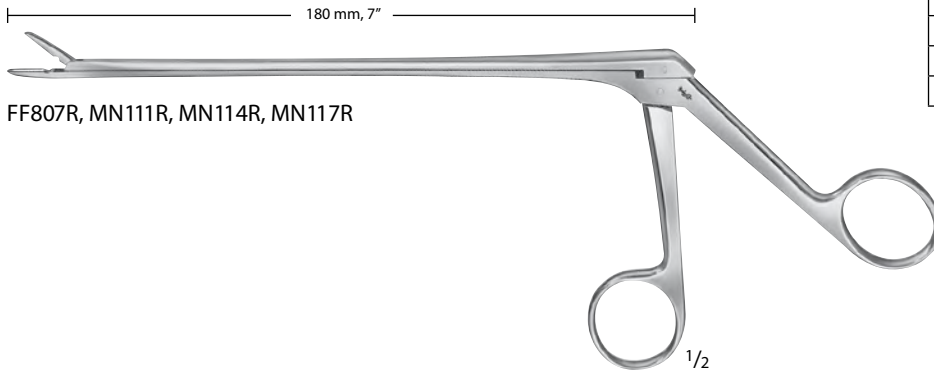

IVD Rongeur

Catalog Number	Jaw Size (mm)	Jaw	Working Length (in.)
MN120R	5 x 10	STR	9
MN123R	5 x 10	STR	11
MN126R	5 x 10	STR	12
MN121R	5 x 10	UP	9
MN124R	5 x 10	UP	11
MN127R	5 x 10	UP	12
MN122R	5 x 10	DOWN	9
MN125R	5 x 10	DOWN	11
MN128R	5 x 10	DOWN	12

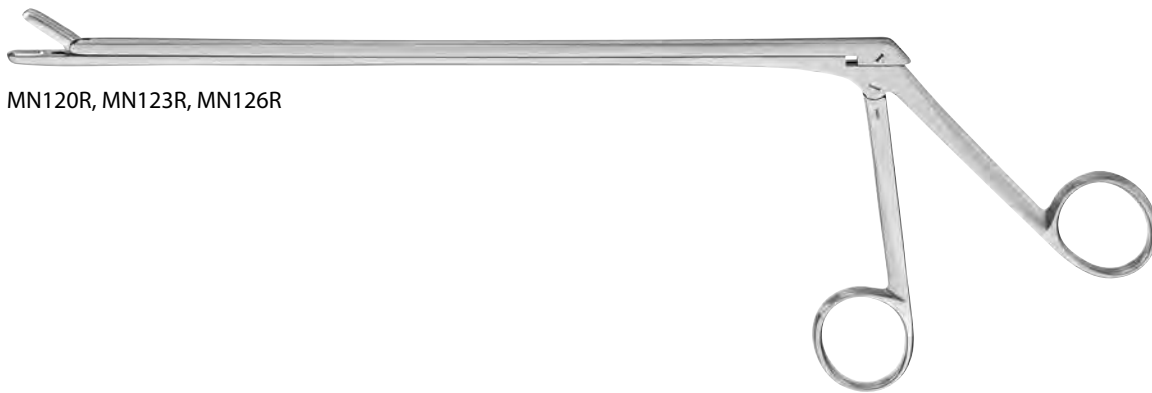

MN120R, MN123R, MN126R



MN121R, MN124R, MN127R



MN122R, MN125R, MN128R

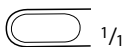

MN120R, MN123R,
 MN126R



MN121R, MN124R,
 MN127R



MN122R, MN125R,
 MN128R

WAGNER Rongeur

Catalog Number	Jaw Size (mm)	Working Length (in.)
FF818R	5.5	7 7/8

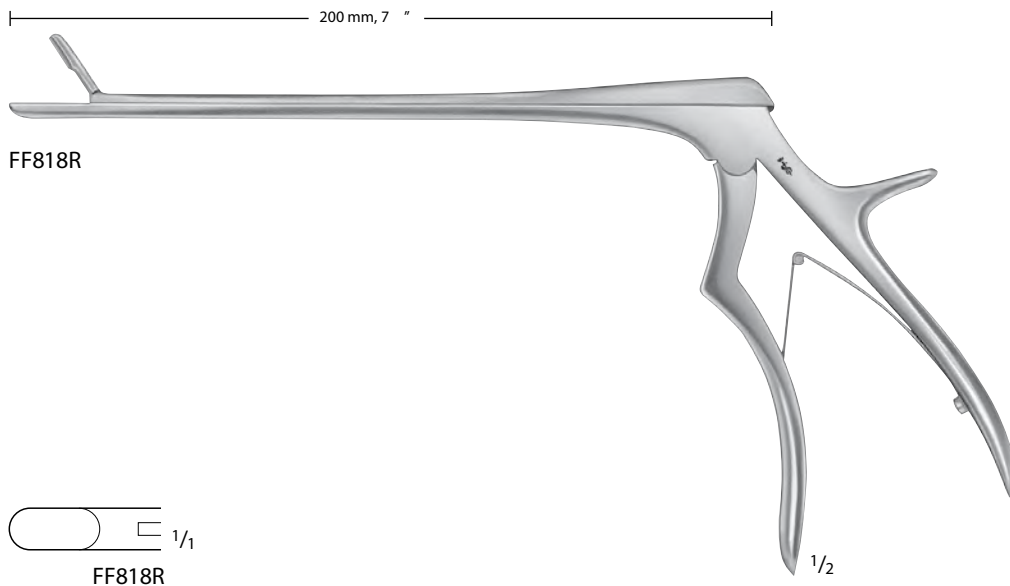

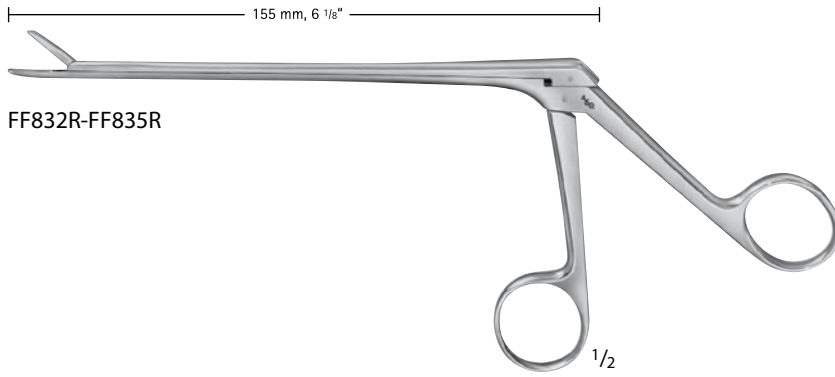

CASPAR Rongeur

Catalog Number	Jaw Size (mm)	Jaw	Working Length (in.)
FF832R	2.0	STR	6 1/8
FF833R	3.0	STR	6 1/8
FF834R	4.0	STR	6 1/8
FF835R	5.0	STR	6 1/8
FF842R	2.0	UP	6 1/8
FF843R	3.0	UP	6 1/8
FF844R	4.0	UP	6 1/8
FF852R	2.0	DOWN	6 1/8
FF853R	3.0	DOWN	6 1/8
FF854R	4.0	DOWN	6 1/8

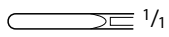

FF832R, FF842R, FF852R

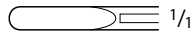

FF833R, FF843R, FF853R

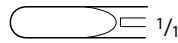

FF834R, FF844R, FF854R

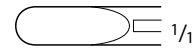

FF835R

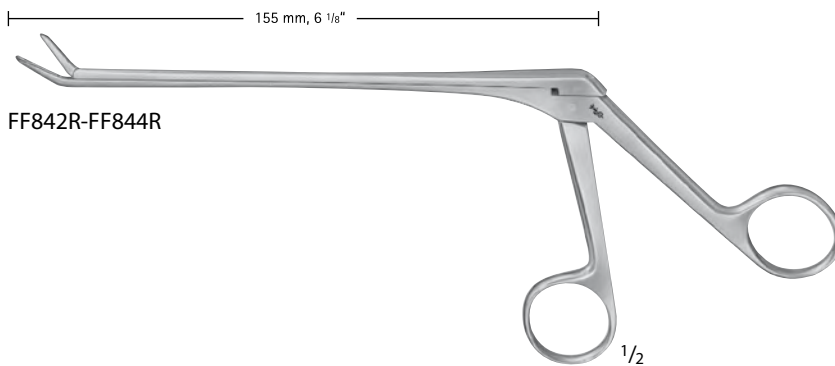

180 mm, 7"

FF856R-FF857R

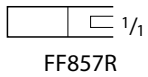

CASPAR Heavy Rongeur, F/ Removal of Hard Disc Pathology

Catalog Number	Jaw Size (mm)	Jaw	Working Length (in.)
FF856R	3.0	STR	7
FF857R	4.0	STR	7

260 mm, 10 1/4"

FG057R

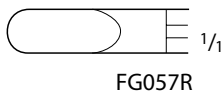

SYPERT Rongeur

Catalog Number	Jaw Size (mm)	Jaw	Working Length (in.)
FG057R	5 x 20	UP	10 1/4

150 mm, 6"

FO820R

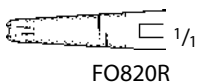

KRAEMER Grasping Forceps, W/ Catch

Catalog Number	Working Length (in.)
FO820R	6

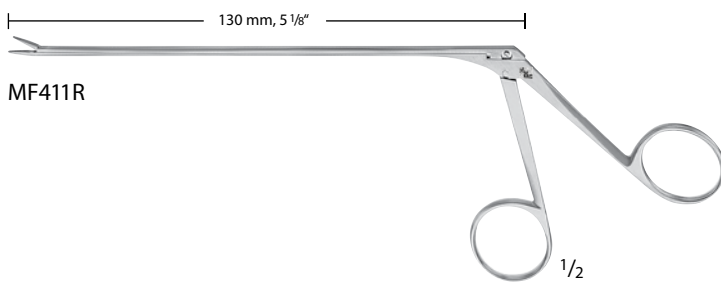
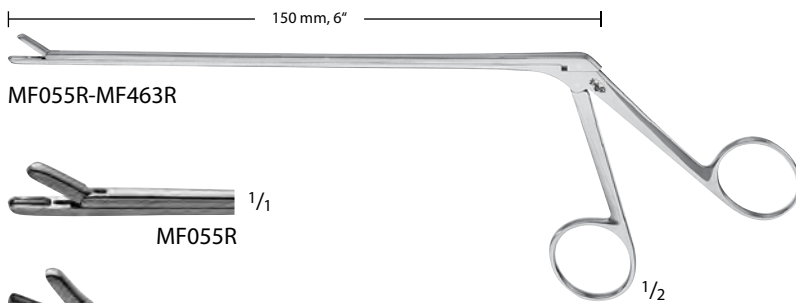
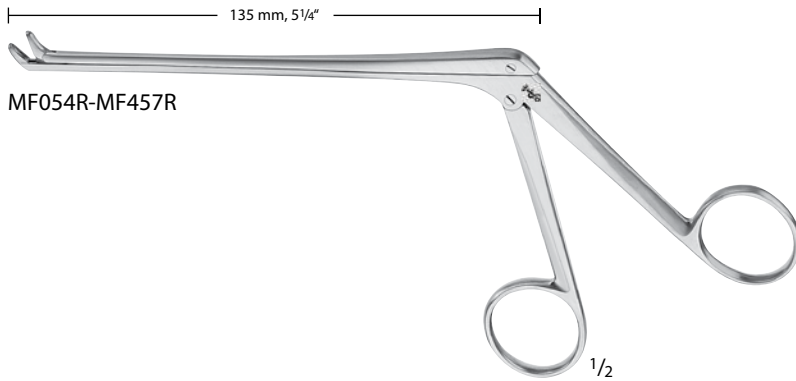

PEAPOD Disc Rongeur

Catalog Number	Jaw Size (mm)	Jaw	Working Length (in.)
MF054R	2 x 6	UP	5 1/2
MF456R	3 x 6	UP	5 1/4
MF457R	4 x 6	UP	5 1/4

DECKER Rongeur

Catalog Number	Jaw Size (mm)	Jaw	Working Length (in.)
MF055R	2 x 6	STR	6
MF462R	2 x 6	UP	6
MF463R	2 x 6	DOWN	6

STEVENSON Grasping Forceps

Catalog Number	Jaw Size (mm)	Jaw	Working Length (in.)
MF411R	6.0	STR	5 1/8

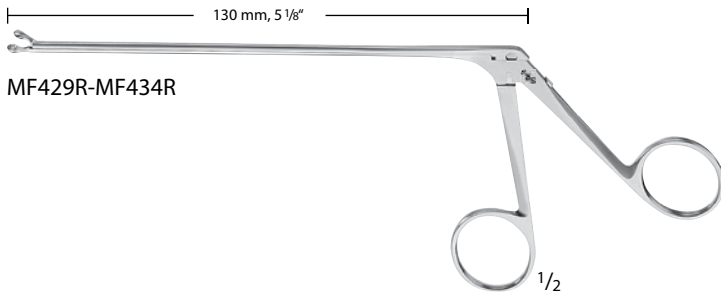

Rhoton Style Cup Forceps

Catalog Number	Jaw Size (mm)	Jaw	Working Length (in.)
MF429R	0.5	STR	5 1/8
MF432R	1.0	STR	5 1/8
MF435R	2.0	STR	5 1/8
MF436R	3.0	STR	5 1/8
MF437R	4.0	STR	5 1/8
MF438R	5.0	STR	5 1/8
MF430R	0.5	RIGHT	5 1/8
MF433R	1.0	RIGHT	5 1/8
MF431R	0.5	LEFT	5 1/8
MF434R	1.0	LEFT	5 1/8

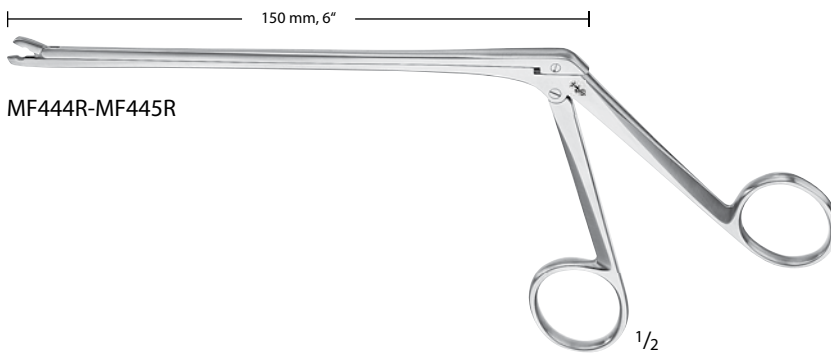

SELVERSTONE Rongeur

Catalog Number	Jaw Size (mm)	Jaw	Working Length (in.)
MF444R	2 x 3	STR	6
MF445R	2 x 5	STR	6

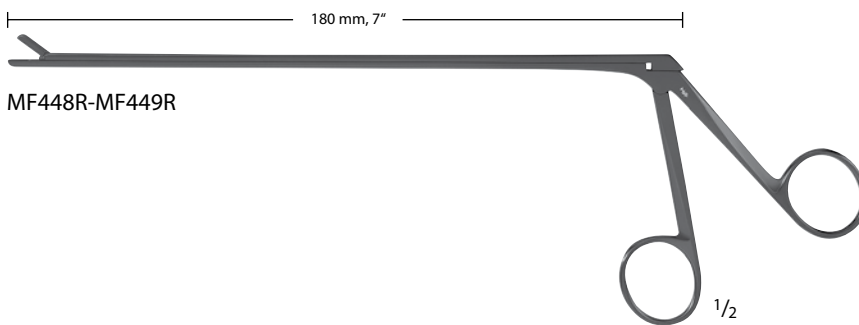

Black Coated Micro Pituitary Rongeur

Catalog Number	Jaw Size (mm)	Jaw	Working Length (in.)
MF448R	2 x 6	STR	7
MF449R	2 x 6	UP	7



MF464R

WILLIAMS Discectomy Forceps

Catalog Number	Jaw Size (mm)	Jaw	Working Length (in.)
MF464R	2 x 6	STR	5 1/4

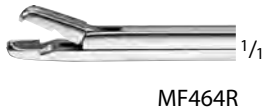

MF464R

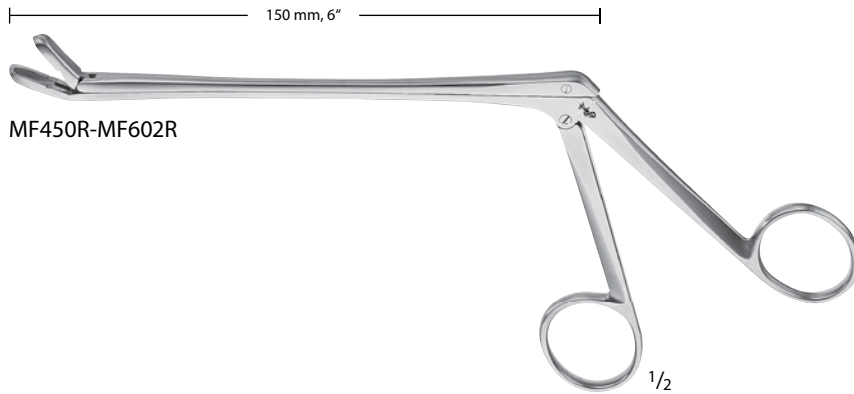

MF450R-MF602R

CLOWARD Style Rongeur

Catalog Number	Jaw Size (mm)	Jaw	Working Length (in.)
MF450R	6 x 10	STR	5 1/4
MF600R	6 x 10	STR	6
MF451R	6 x 10	UP	5 1/4
MF601R	6 x 10	UP	6
MF452R	6 x 10	DOWN	5 1/4
MF602R	6 x 10	DOWN	6



MF450R-MF602R

SYPERT Kerrison Bone Punch

Catalog Number	Jaw Size (mm)	Tip	Working Length (in.)
FG055R	5.5	40° UP	9 3/4



FG055R



FG055R

Let Us know if you could not find what you are looking for

Three Primary Styles

- Non Detachable, silver
- Detachable, silver
- Detachable, ceramic NOIR coating

Complete Size and Footplate Range

- Regular and thin footplates
- 7", 8", 9", 11" lengths
- 1-6 mm bite sizes
- 15 mm Laminectomy jaw length
- 40° and 90° up and down jaw positions

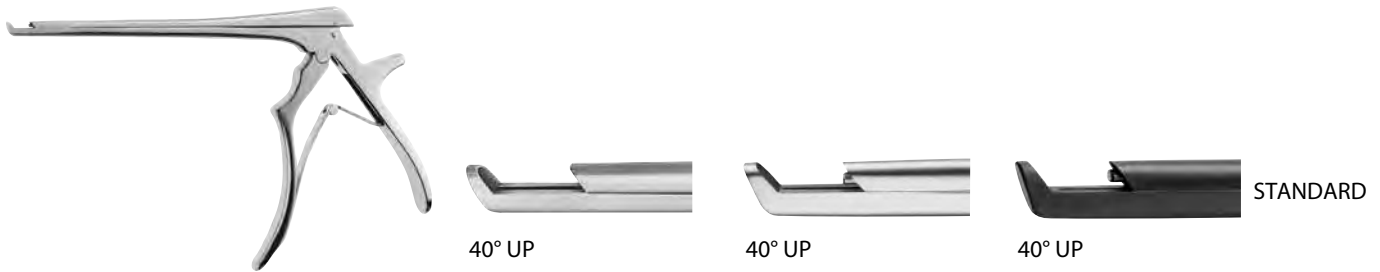

Working Length (in.)	Jaw Size (mm)	Footplate	Non Detachable, Silver	Ejector	Detachable, Silver	Ejector	Detachable, NOIR Coating	Ejector
7	1.0	STANDARD	FF715R	-	FK900R	-	FK900B	-
7	1.5	STANDARD	FF638R	-	FK911R	-	FK911B	-
7	2.0	STANDARD	FF717R	-	FK901R	✓	FK901B	✓
7	2.5	STANDARD	FF639R	-	FK912R	✓	FK912B	✓
7	3.0	STANDARD	FF720R	-	FK902R	✓	FK902B	✓
7	4.0	STANDARD	FF724R	-	FK903R	✓	FK903B	✓
7	5.0	STANDARD	FF722R	-	FK904R	✓	FK904B	✓
7	6.0	STANDARD	FF726R	-	FK905R	✓	FK905B	✓

7 7/8	1.0	STANDARD	FF691R	-	FK960R	-	FK960B	-
7 7/8	1.5	STANDARD	FF649R	-	FK966R	-	FK966B	-
7 7/8	2.0	STANDARD	FF737R	-	FK913R	✓	FK913B	✓
7 7/8	2.5	STANDARD	FF657R	-	FK967R	✓	FK967B	✓
7 7/8	3.0	STANDARD	FF738R	-	FK914R	✓	FK914B	✓
7 7/8	4.0	STANDARD	FF727R	-	FK915R	✓	FK915B	✓
7 7/8	5.0	STANDARD	FF728R	-	FK916R	✓	FK916B	✓
7 7/8	6.0	STANDARD	FF729R	-	FK917R	✓	FK917B	✓

9	1.0	STANDARD	FF674R	-	FK918R	-	FK918B	-
9	2.0	STANDARD	FF682R	-	FK919R	✓	FK919B	✓
9	3.0	STANDARD	FF683R	-	FK920R	✓	FK920B	✓
9	4.0	STANDARD	FF684R	-	FK921R	✓	FK921B	✓
9	5.0	STANDARD	FF685R	-	FK922R	✓	FK922B	✓

11	1.0	STANDARD	FF696R	-	FK981R	-	FK981B	-
11	2.0	STANDARD	FF686R	-	FK986R	✓	FK986B	✓
11	3.0	STANDARD	FF687R	-	FK987R	✓	FK987B	✓
11	4.0	STANDARD	FF688R	-	FK988R	✓	FK988B	✓
11	5.0	STANDARD	FF689R	-	FK989R	✓	FK989B	✓
11	6.0	STANDARD	FF690R	-	-	-	-	-

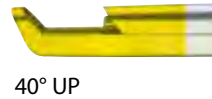

Working Length (in.)	Jaw Size (mm)	Footplate	Non Detachable, Silver	Ejector	Detachable, Silver	Ejector	Detachable, NOIR Coating	Ejector
7	1.0	THIN	FF771R	-	FK906R	-	FK906B	-
7	1.5	THIN	FF645R	-	FK923R	-	FK923B	-
7	2.0	THIN	FF772R	-	FK907R	✓	FK907B	✓
7	2.5	THIN	FF646R	-	FK924R	✓	FK924B	✓
7	3.0	THIN	FF773R	-	FK908R	✓	FK908B	✓
7	4.0	THIN	FF769R	-	FK909R	✓	FK909B	✓
7	5.0	THIN	FF770R	-	FK910R	✓	FK910B	✓
7 7/8	1.0	THIN	FF661R	-	FK961R	-	FK961B	-
7 7/8	1.5	THIN	FF658R	-	FK968R	-	FK968B	-
7 7/8	2.0	THIN	FF662R	-	FK962R	✓	FK962B	✓
7 7/8	2.5	THIN	FF659R	-	FK969R	✓	FK969B	✓
7 7/8	3.0	THIN	FF663R	-	FK963R	✓	FK963B	✓
7 7/8	4.0	THIN	FF664R	-	FK964R	✓	FK964B	✓
7 7/8	5.0	THIN	FF665R	-	FK965R	✓	FK965B	✓
9	1.0	THIN	FF734R	-	FK929R	-	FK929B	-
9	2.0	THIN	FF746R	-	FK925R	✓	FK925B	✓
9	3.0	THIN	FF747R	-	FK926R	✓	FK926B	✓
9	4.0	THIN	FF748R	-	FK927R	✓	FK927B	✓
9	5.0	THIN	FF749R	-	FK928R	✓	FK928B	✓
11	1.0	THIN	FF673R	-	FK980R	-	FK980B	-
11	2.0	THIN	FF666R	-	FK976R	✓	FK976B	✓
11	3.0	THIN	FF667R	-	FK977R	✓	FK977B	✓
11	4.0	THIN	FF668R	-	FK978R	✓	FK978B	✓
11	5.0	THIN	FF669R	-	FK979R	✓	FK979B	✓



40° UP



40° UP



40° UP

STANDARD

Working Length (in.)	Jaw Size (mm)	Jaw Opening (mm)	Footplate	Non Detachable, Silver	Ejector	Detachable, Silver	Ejector	Detachable, NOIR Coating	Ejector
7	2.0	15	STANDARD	FF677R	-	FK971R	✓	FK971B	✓
7	3.0	15	STANDARD	FF678R	-	FK972R	✓	FK972B	✓
7	4.0	15	STANDARD	FF679R	-	FK973R	✓	FK973B	✓
7	5.0	15	STANDARD	FF680R	-	FK974R	✓	FK974B	✓
7	6.0	15	STANDARD	-	-	FK975R	✓	FK975B	✓

7 7/8	2.0	15	STANDARD	FF660R	-	FK970R	✓	FK970B	✓
7 7/8	3.0	15	STANDARD	FF739R	-	FK982R	✓	FK982B	✓
7 7/8	4.0	15	STANDARD	FF745R	-	FK983R	✓	FK983B	✓
7 7/8	5.0	15	STANDARD	FF751R	-	FK984R	✓	FK984B	✓
7 7/8	6.0	15	STANDARD	FF753R	-	FK985R	✓	FK985B	✓



90° UP

STANDARD

Working Length (in.)	Jaw Size (mm)	Jaw Opening (mm)	Non Detachable, Silver	Ejector
7	3	15	FF136R	-
7	4	15	FF137R	-
7	5	15	FF138R	-

8	3	15	FF086R	-
8	4	15	FF087R	-
8	5	15	FF088R	-



40° DOWN



STANDARD

40° DOWN

Working Length (in.)	Jaw Size (mm)	Footplate	Non Detachable, Silver	Ejector	Detachable, Silver	Ejector
7	1.0	STANDARD	FF711R	-	FK930R	-
7	2.0	STANDARD	FF712R	-	FK931R	✓
7	3.0	STANDARD	FF713R	-	FK932R	✓
7	4.0	STANDARD	FF714R	-	FK933R	✓
7	5.0	STANDARD	FF725R	-	FK934R	✓

9	2.0	STANDARD	FF692R	-	FK943R	✓
9	3.0	STANDARD	FF693R	-	FK944R	✓
9	4.0	STANDARD	FF694R	-	FK945R	✓
9	5.0	STANDARD	FF695R	-	FK946R	✓



40° DOWN



STANDARD

40° DOWN

Working Length (in.)	jaw Size (mm)	Footplate	Non Detachable, Silver	Ejector	Detachable, Silver	Ejector
7	1.0	THIN	FF781R	-	FK936R	-
7	2.0	THIN	FF782R	-	FK937R	✓
7	3.0	THIN	FF783R	-	FK938R	✓
7	4.0	THIN	FF784R	-	FK939R	✓
7	5.0	THIN	FF785R	-	FK940R	✓



Working Length (in.)	Jaw Size (mm)	Footplate	Non Detachable, Silver	Ejector	Detachable, Silver	Ejector	Detachable NOIR Coating	Ejector
7	1.0	STANDARD	FF716R	-	FK948R	-	FK948B	-
7	2.0	STANDARD	FF718R	-	FK949R	-	FK949B	✓
7	3.0	STANDARD	FF750R	-	FK950R	✓	FK950B	✓
7	4.0	STANDARD	FF752R	-	FK951R	✓	FK951B	✓
7	5.0	STANDARD	FF754R	-	FK952R	✓	FK952B	✓
7	6.0	STANDARD	FF755R	-	FK953R	✓	FK953B	✓

8	1.0	STANDARD	FF025R	-
8	2.0	STANDARD	FF026R	-
8	3.0	STANDARD	FF027R	-
8	4.0	STANDARD	FF028R	-
8	5.0	STANDARD	FF029R	-



Working Length (in.)	Jaw Size (mm)	Footplate	Non Detachable, Silver	Ejector
7	1	THIN	FF115R	-
7	2	THIN	FF116R	-
7	3	THIN	FF117R	-
7	4	THIN	FF118R	-
7	5	THIN	FF119R	-

8	2	THIN	FF077R	-
8	3	THIN	FF078R	-
8	4	THIN	FF079R	-
8	5	THIN	FF080R	-



Working Length (in.)	Jaw Size (mm)	Footplate	Non Detachable, Silver	Ejector	Detachable, Silver	Ejector
7	1.0	STANDARD	FF741R	-	FK954R	-
7	2.0	STANDARD	FF719R	-	FK955R	-
7	3.0	STANDARD	FF721R	-	FK956R	✓
7	4.0	STANDARD	FF742R	-	FK957R	✓
7	5.0	STANDARD	FF723R	-	FK958R	✓
7	6.0	STANDARD	FF743R	-		

8	2	STANDARD	FF828R	-
8	3	STANDARD	FF829R	-
8	4	STANDARD	FF830R	-
8	5	STANDARD	FF831R	-
8	6	STANDARD	FF841R	-



Working Length (in.)	Jaw Size (mm)	Footplate	Non Detachable, Silver	Ejector
7	1.0	THIN	MF136R	-
7	2.0	THIN	FF816R	-
7	3.0	THIN	FF817R	-
7	4.0	THIN	FF819R	-
7	5.0	THIN	FF821R	-

8	1.0	THIN	FF809R	-
8	2.0	THIN	FF812R	-
8	3.0	THIN	FF813R	-
8	5.0	THIN	FF815R	-

Foraminotomy Kerrison

- Non Detachable design
- Upward curve allows for easier bone removal, providing improved access to the underside of the foramen

KERRISON Foraminotomy Bone Punch

Catalog Number	Jaw Size (mm)	Jaw Opening (mm)	Working Length (in.)
FF466R	2.0	10	7 7/8
FF467R	3.0	10	7 7/8
FF468R	4.0	10	7 7/8
FF469R	5.0	10	7 7/8



FF466R-FF469R

Bayonet-Shaped Kerrison bone punch

- Non Detachable design
- Bayonet shape allows better view over the KERRISON and increased visibility of surgical site
- Easily used through a retractor tube for MIS procedures

KERRISON Bayonet-Shaped Bone Punch, 40° upbiting

Catalog Number	Jaw Size (mm)	Jaw Opening (mm)	Working Length (in.)
FF496R	2.0	10	9 1/2
FF497R	3.0	10	9 1/2
FF498R	4.0	10	9 1/2
FF499R	5.0	10	9 1/2

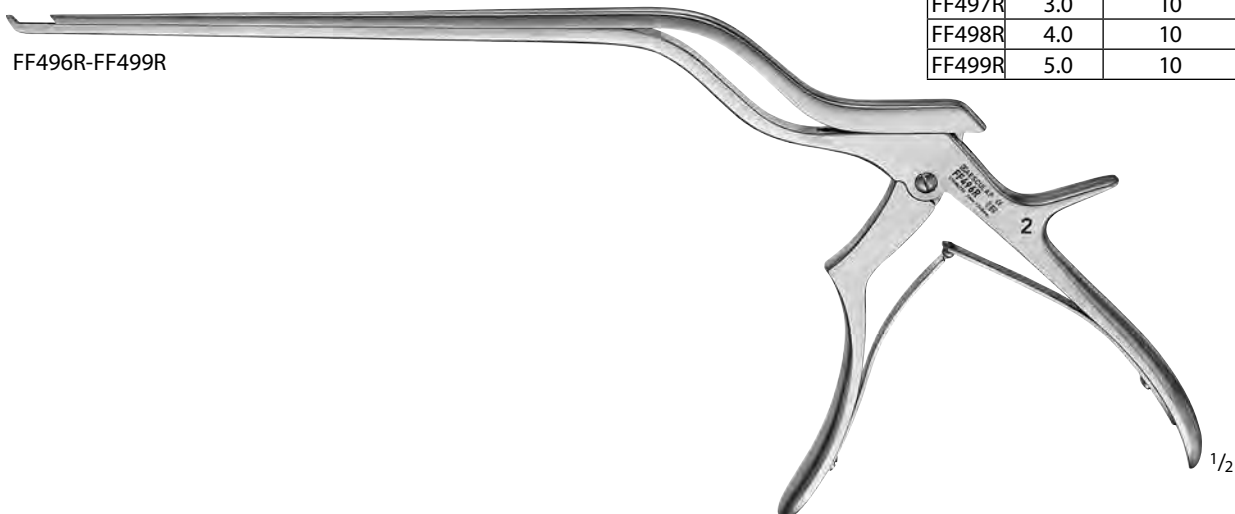

FF496R-FF499R

KAIRison Pneumatic Bone Punch

- Easy handling
- Reduces physical effort required
- Relieves strain on hands and joints
- Less risk of reduced motor skills through fatigue
- Innovative safety mechanism
- Short learning curve
- Excellent balance
- Suitable for right- or left-handed use
- Reliable; does not jam
- Ergonomic design

KAIRison Pneumatic Bone Punch

Catalog Number	Jaw Size (mm)	Jaw Opening (mm)	Footplate	Ejector	Total Length (in.)
FK882R	2.0	12	STANDARD	✓	9 1/4
FK883R	3.0	12	STANDARD	✓	9 1/4
FK884R	4.0	12	STANDARD	✓	9 1/4
FK885R	5.0	12	STANDARD	✓	9 1/4
FK886R	6.0	12	STANDARD	✓	9 1/4
FK892R	2.0	12	STANDARD	✓	11 1/4
FK893R	3.0	12	STANDARD	✓	11 1/4
FK894R	4.0	12	STANDARD	✓	11 1/4
FK895R	5.0	12	STANDARD	✓	11 1/4
FK896R	6.0	12	STANDARD	✓	11 1/4

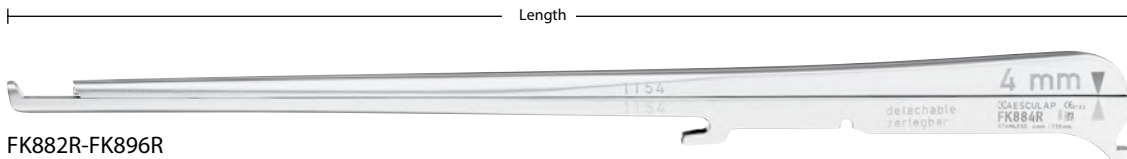

FK882R-FK896R

Width (mm) 2.0 3.0 4.0 5.0 6.0



FK899R

KAIRison Pneumatic Punch Handle

Catalog Number
FK899R

Punch Bracket For Pressure Reduc



Pressure Reducer

FK898R-FK898214

KAIRison Pressure Reducer

Catalog Number	Description
FK898R	PRESSURE REDUCER
FK887R	BRACKET FOR PRESSURE REDUCER
FK898215	RUBBER CAP, SMALL
FK898214	RUBBER CAP, LARGE



FK888SU

Disposable Tubes for KAIRison
Pneumatic Punch

Catalog Number	Packaging
FK888SU	PAK = Package of 10

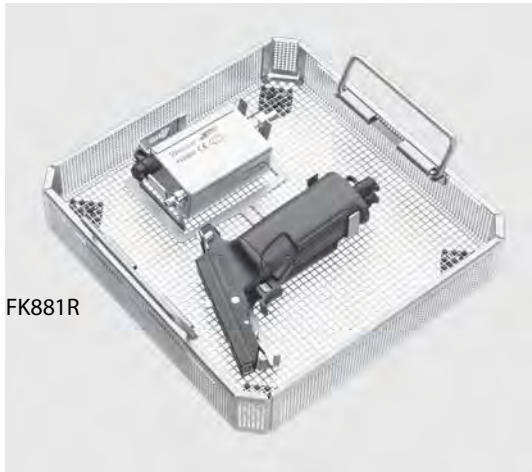

FK881R

Storage Rack for KAIRison Handle and
Pressure Reducer

Catalog Number
FK881R

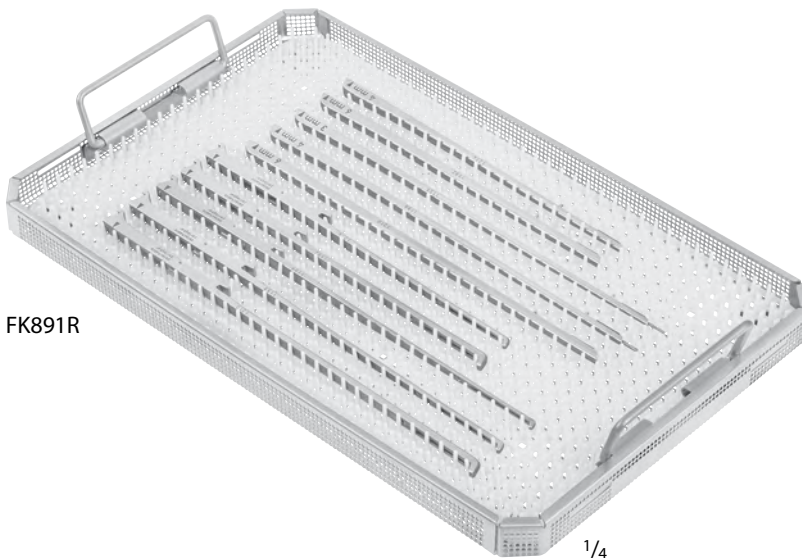

FK891R

Storage Rack for KAIRison Shafts

Catalog Number
FK891R



GA468R

Pneumatic Hose with -
Schrader Connection

Catalog Number	Length (m)
GA468R	5



FO601R-FO602R

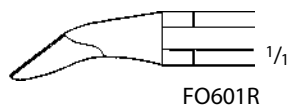

FO601R

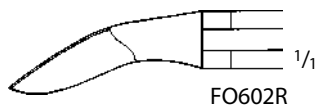

FO602R



FO604R

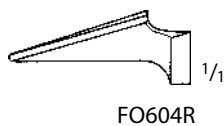

FO604R



FO612R

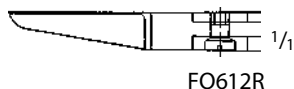

FO612R

Bone Cutting Forceps

Catalog Number	Jaw	Length (in.)
FO601R	UP	5 1/8
FO602R	UP	6 3/4

STAMM Bone Cutting Forceps

Catalog Number	Length (in.)
FO604R	6

Bone Cutting Forceps, Double Action

Catalog Number	Jaw	Length (in.)
FO612R	STR	6 3/4



FO620R-FO636R

1/2



FO620R

1/1

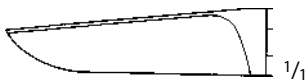

FO622R

1/1



FO624R

1/1



FO626R

1/1

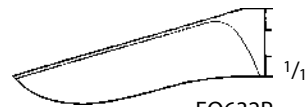

FO632R

1/1



FO634R

1/1



FO636R

1/1

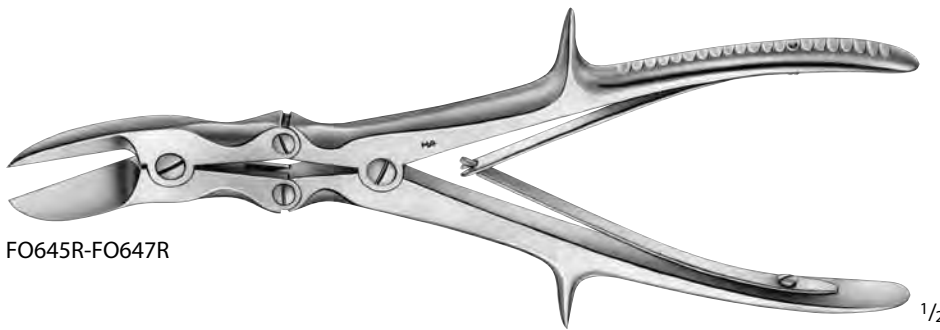

FO645R-FO647R

1/2

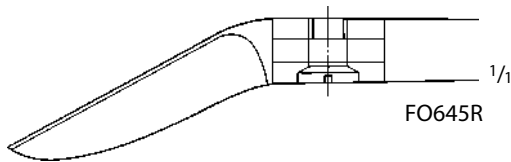

FO645R

1/1

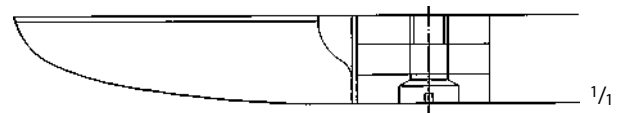

FO646R

1/1

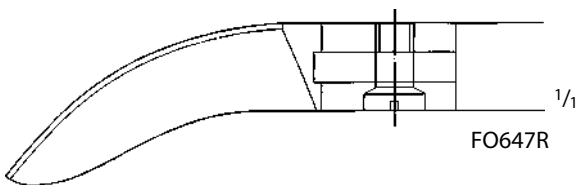

FO647R

1/1

LISTON Bone Cutting Forceps

Catalog Number	Jaw	Length (in.)
FO620R	STR, Single Action	5 1/2
FO622R	STR, Single Action	6 3/4
FO624R	STR, Single Action	7 7/8
FO626R	STR, Single Action	8 3/4
FO632R	ANG, Single Action	6 3/4
FO634R	ANG, Single Action	7 7/8
FO636R	ANG, Single Action	8 3/4
FO645R	CVD, Double Action	9 1/2
FO646R	STR, Double Action	11
FO647R	CVD, Double Action	11

Let Us know if you could not find what you are looking for



FO610R-FO611R

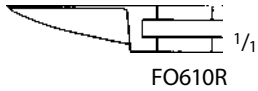

FO610R

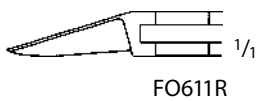

FO611R



FO614R

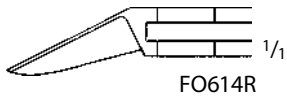

FO614R



FO640R-FO641R

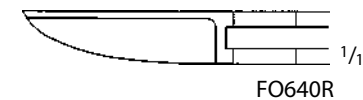

FO640R

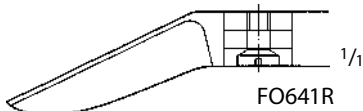

FO641R

BOEHLER Bone Cutting Forceps, Double Action

Catalog Number	Jaw	Length (in.)
FO610R	STR	5 3/4
FO611R	ANG	5 3/4

MCINDOE Bone Cutting Forceps, Double Action

Catalog Number	Jaw	Length (in.)
FO614R	ANG	6 7/8

RUSKIN-LISTON Bone Cutting Forceps, Double Action

Catalog Number	Jaw	Length (in.)
FO640R	STR	7 1/2
FO641R	ANG	7 1/2



LISTON-STILLE Bone Cutting Forceps,
 90° Angle

Catalog Number	Length (in.)
FO648R	10 1/2

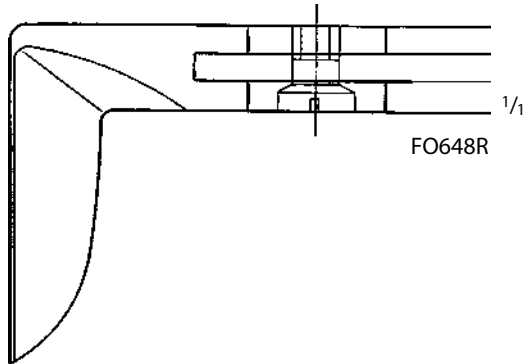

LISTON-KEY-HORSLEY Bone Cutting
 Forceps, Angled

Catalog Number	Length (in.)
FO649R	10

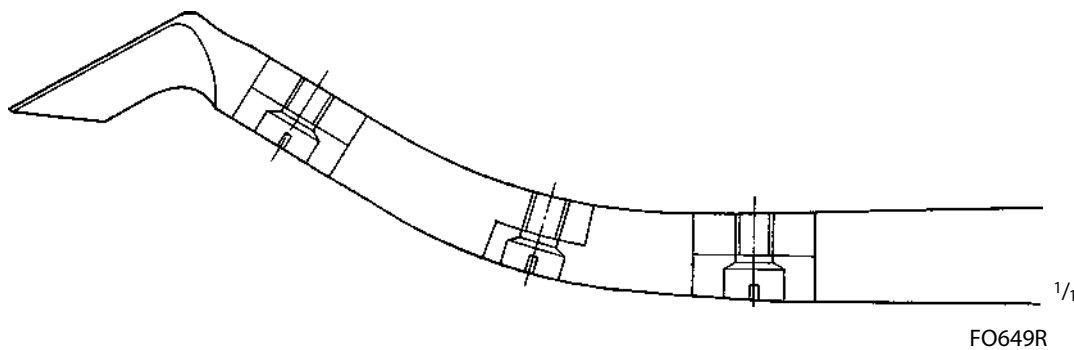

KAZANJIAN Bone Cutting Forceps,
 Straight

Catalog Number	Length (in.)
OK378R	7 1/4



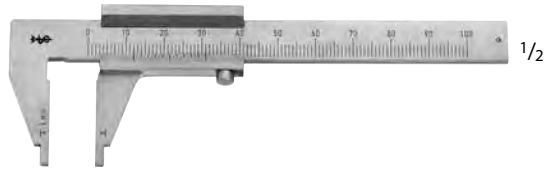

AA847R



AA846R

Caliper for Inner Diameter and Outer Diameter

Catalog Number	Measuring Range	Length (in.)
AA847R	UP TO 100MM	5 1/8
AA846R	UP TO 150MM	9

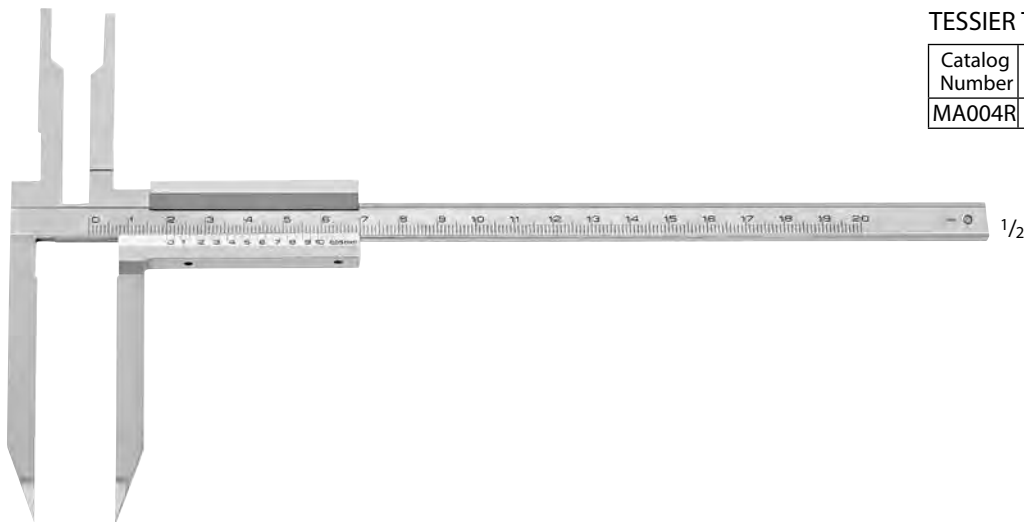

MA004R

TESSIER Type Caliper

Catalog Number	Length (in.)
MA004R	10 1/4

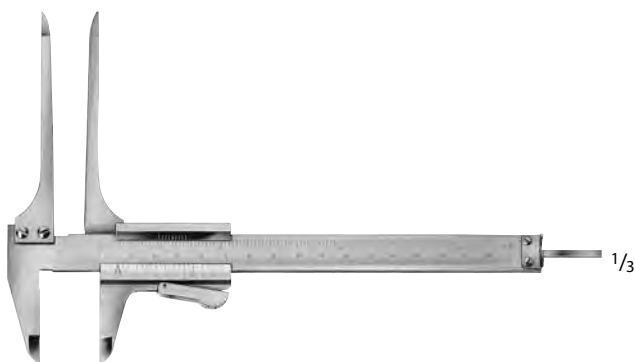

AA845R

CASPAR Neuro Caliper F/ Bone Graft

Catalog Number	Length (in.)
AA845R	8 7/8



MB983R

TOWNLEY Femur Caliper

Catalog Number	Length (in.)
MB983R	4



AA804R-AA806R

Steel Ruler, Graduated In Millimeters and Inches

Catalog Number	Length (in.)
AA804R	6
AA805R	11 3/4
AA806R	19 3/4



MD531R

CLOWARD Style Depth Gauges

Catalog Number	Size	Length (in.)
MD531R	LARGE	8

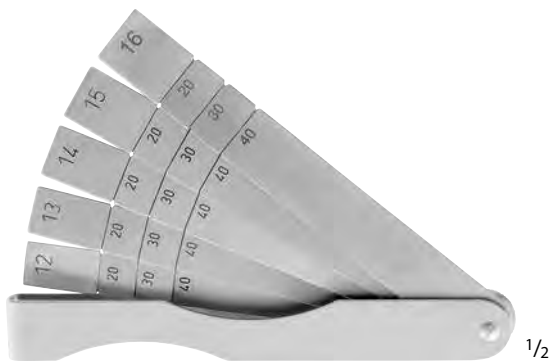

MD534R

CLOWARD Spanner Gauges

Catalog Number	Length (in.)
MD534R	5

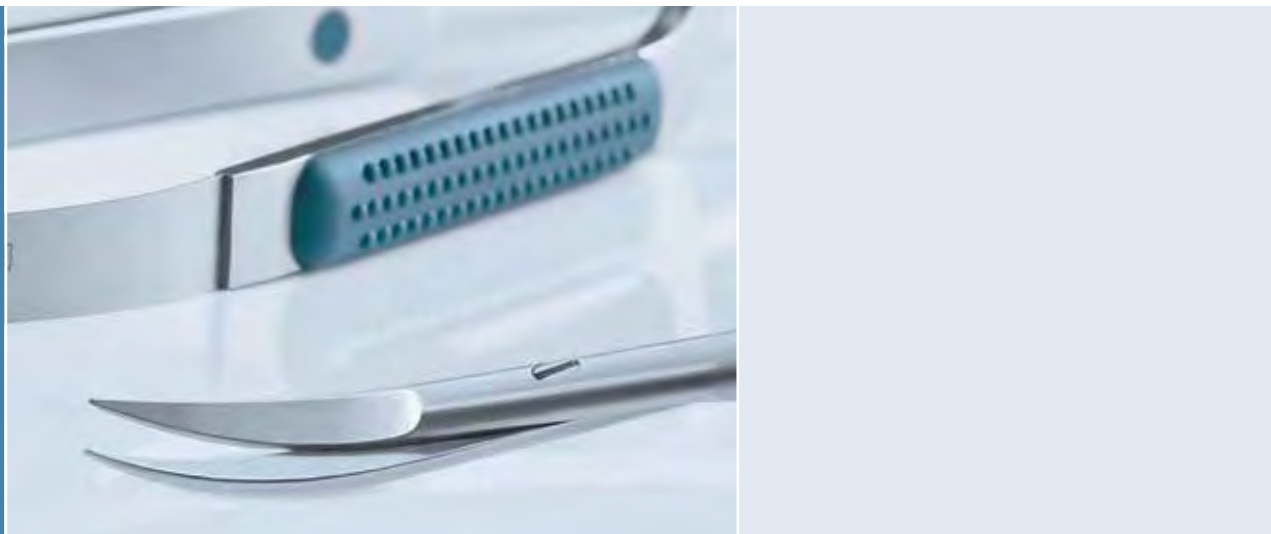

Neurosurgery

Skull Opening	1068 - 1073
Micro Scissors	1074 - 1077
Micro Forceps	1078 - 1079
Tumor Forceps	1079 - 1081
Micro Needle Holders	1082
MIN Instruments	1083 - 1087
SENSATION Instruments	1088 - 1095
XS Instruments	1096 - 1100
EC/IC Bypass Instruments	1101 - 1103
Skull Base Instruments	1104 - 1105
Micro Dissectors/Rasps/Hooks	1106 - 1122
Suture and Ligature Instruments	1123
Dural Separators	1124
Knives	1124 - 1126
Pituitary Instruments	1127 - 1143
Suction Cannulas	1144 - 1152
Elevators	1153
Retractors and Handrest Systems	1154 - 1162
Brain Spatulas	1163 - 1165



FF007P

ScalpFix® Applicator, Polymer

Catalog Number
FF007P



FF012R

ScalpFix Applicator, Aluminum

Catalog Number
FF012R



FF013P

ScalpFix Scalp Clip, Single Use

Catalog Number	Packaging
FF013P	BOX = 20 PAC OF 10 PC (200 CLIPS TOTAL)

ScalpFix® Removal Forceps

Catalog Number	Length (in.)
FF014R	6



FF014R

1/2

RANEY Plastic Scalp Hemostasis Clip, Sterile

Catalog Number	Sales Unit
FF015P	BOX = 20 PACK OF 10 PC (200 CLIPS TOTAL)



FF015P

1/1

RANEY Applying and Removing Forceps for Scalp Hemostasis Clips

Catalog Number	Compatible w/	Length (in.)
FF003R	FF015P	6 1/4

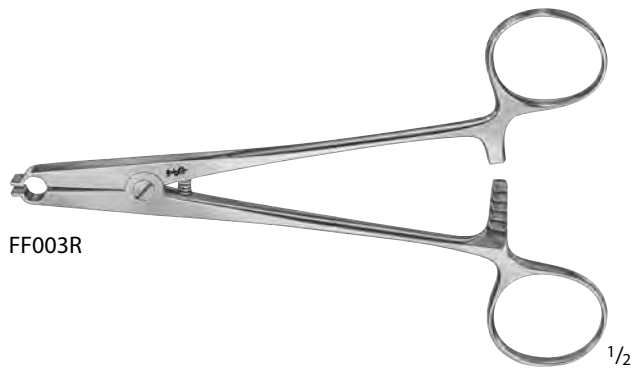

FF003R

1/2

Scalp Hemostasis Clip

Catalog Number	Sales Unit
FF005R	BOX OF 10



FF005R

1/2



FF010R-FF011R



Scalp Flap Forceps

Catalog Number	Author	Shape	Length (in.)
FF010R	DEMARTEL	SLIGHT-CVD	5 1/4
FF011R	WILLETT-DEMARTEL	SLIGHT-CVD	7 1/4



FF020R-FF022R

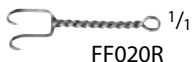

YASARGIL Spring Hook, F/ Galea Fixation W/ Bulldog Clamp

Catalog Number	Tip
FF020R	SMALL
FF022R	LARGE

Galea Hook, W/ Ball Chain

Catalog Number	Compatible w/
FF155R	FF154R

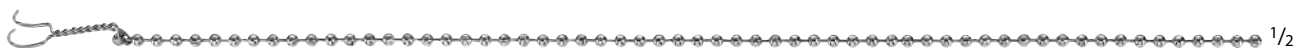

FF155R



FF155R

Galea Hook, W/ Ball Chain and Spiral Spring

Catalog Number	Compatible w/
FF156R	FF154R



FF156R

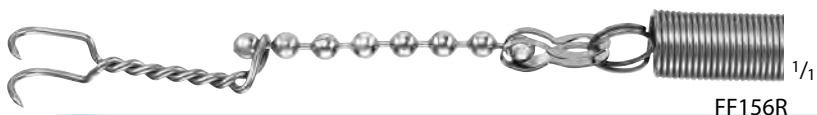

FF156R



FF056R

HUDSON Drill Brace

Catalog Number
FF056R



FF057R

HUDSON Drill Brace Extension

Catalog Number
FF057R



FF061R



FF062R

HUDSON Burr

Catalog Number	Diameter (mm)
FF061R	9.0
FF062R	14.0
FF063R	16.0
FF064R	22.0



FF063R



FF064R



FF065R

ADSON Burr

Catalog Number	Diameter (mm)
FF065R	15.0



FF066R

MCKENZIE Twist Drill

Catalog Number	Diameter (mm)
FF066R	13.0



FF067R

CUSHING Flat Drill

Catalog Number	Diameter (mm)
FF067R	14.0



FF068R

Twist Drill

Catalog Number	Diameter (mm)
FF068R	2.0

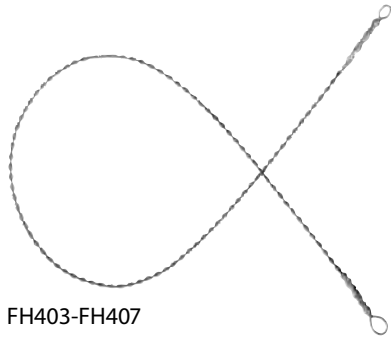

FH403-FH407



FH403-FH407

OLIVECRONA Wire Saw

Catalog Number	Diameter (mm)	Sales Unit	Length (in.)
FH403	1.2	BOX OF 5	11 3/4
FH404	1.2	BOX OF 5	15 3/4
FH405	1.2	BOX OF 5	19 3/4
FH407	1.2	BOX OF 5	27 1/2

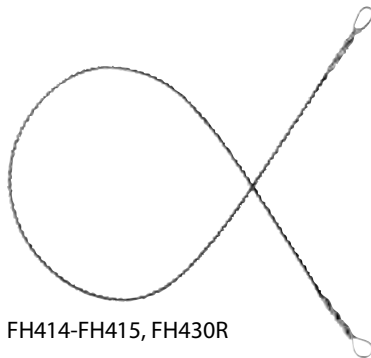

FH414-FH415, FH430R



FH414-FH415, FH430R

GIGLI Wire Saw

Catalog Number	Diameter (mm)	Wires	Sales Unit	Length (in.)
FH414	1.4	6	BOX OF 5	15 3/4
FH415	1.4	6	BOX OF 5	19 3/4
FH430R	1.8	4	BOX OF 5	19 3/4



MB986R

1/2

GIGLI Saw Handle F/ Wire Saws

Catalog Number	Packaging
MB986R	2 PER PACKAGE



FH480R

1/2

GIGLI Hook Handle, F/ Wire Saws

Catalog Number	Packaging
FH480R	2/SET

1/2

DEMARTEL Conductor

Catalog Number	Compatible w/	Length (in.)
FF130R	GIGLI AND OLIVECRONA WIRE SAWS	13 3/4



FF130R



FD030R-FD031R

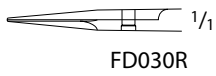

FD030R

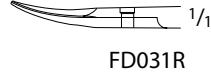

FD031R



FD075R

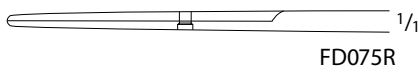

FD075R



FD032R-FD033R

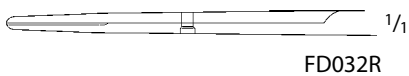

FD032R

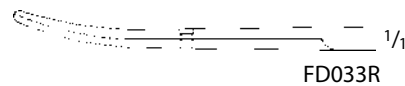

FD033R



FD034R-FD036R

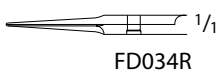

FD034R

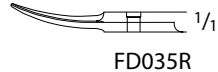

FD035R

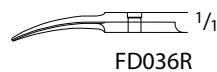

FD036R

YASARGIL Micro Scissors

Catalog Number	Tip	Blade	Length (in.)
FD030R	S/S	STR	6 1/2
FD031R	S/S	CVD-UP	6 1/2

YASARGIL Micro Dissecting Scissors

Catalog Number	Tip	Blade	Length (in.)
FD075R	B/B	STR	7 1/4

YASARGIL Micro Dissecting Scissors

Catalog Number	Tip	Blade	Length (in.)
FD032R	B/B	STR, SERR	7 7/8
FD033R	B/B	CVD-UP, SERR	7 7/8

YASARGIL Micro Scissors

Catalog Number	Tip	Blade	Length (in.)
FD034R	S/S	STR, SERR	7 7/8
FD035R	S/S	CVD-UP, SERR	7 7/8
FD036R	S/S	CVD-DOWN, SERR	7 7/8



FD038R-FD060R

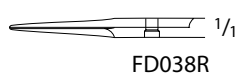

FD038R

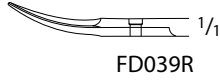

FD039R

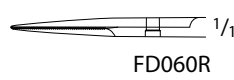

FD060R

YASARGIL Micro Scissors

Catalog Number	Tip	Blade	Length (in.)
FD038R	S/S	STR	8 7/8
FD039R	S/S	CVD-UP	8 7/8
FD060R	S/S	STR, TOOTHED	8 7/8



FD043R-FD044R

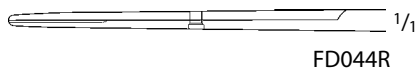

FD044R

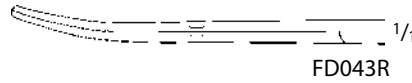

FD043R

YASARGIL Micro Dissecting Scissors

Catalog Number	Tip	Blade	Length (in.)
FD044R	S/S	STR	8 7/8
FD043R	S/S	CVD-UP	8 7/8



FD037R-FD040R

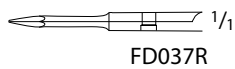

FD037R

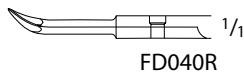

FD040R

YASARGIL Micro Scissors

Catalog Number	Tip	Blade	Length (in.)
FD037R	S/S	STR	8 7/8
FD040R	S/S	CVD-UP	8 7/8



FD061R

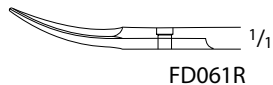

FD061R

YASARGIL Micro Scissors

Catalog Number	Tip	Blade	Length (in.)
FD061R	S/S	CVD-UP	9 5/8



FD062R

1/2



1/1

FD062R

YASARGIL Wire Cutting Scissors

Catalog Number	Tip	Blade	Length (in.)
FD062R	S/S	1-SERR	8 1/4



FD105R-FD108R

1/2



1/1

FD105R



1/1

FD106R

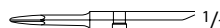

1/1

FD107R

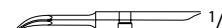

1/1

FD108R

Micro Vessel Scissors

Catalog Number	Tip	Blade	Length (in.)
FD105R	S/S	STR	7 1/2
FD106R	S/S	CVD	7 1/2
FD107R	S/S	DEL, STR	7 1/2
FD108R	S/S	DEL, CVD	7 1/2



FD056R-FD057R

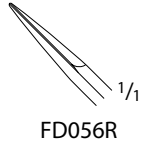

FD056R

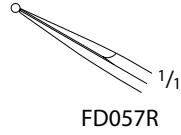

FD057R

NAGEL Micro Scissors

Catalog Number	Tip	Blade	Length (in.)
FD056R	S/S	45°	7 7/8
FD057R	1 BALL-PT	45°	7 7/8



FD059R

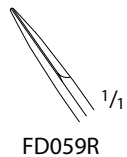

FD059R

DEBAKEY Circumflex Micro Scissors

Catalog Number	Tip	Blade	Length (in.)
FD059R	S/S	125°	7 1/2



BD835R-BD837R



BD835R

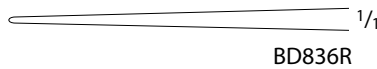

BD836R



BD837R

YASARGIL Micro Forceps,
 Bayonet-Shaped

Catalog Number	Tip Size (mm)	Teeth	Length (in.)
BD835R	0.6	-	7
BD836R	0.9	-	7
BD837R	-	1 x 2	7



BD840R-BD841R



BD840R



BD841R

YASARGIL Micro Forceps,
 Bayonet-Shaped

Catalog Number	Tip Size (mm)	Length (in.)
BD840R	0.6	7 7/8
BD841R	0.9	7 7/8



BD845R-BD846R



BD845R



BD846R

YASARGIL Micro Forceps,
 Bayonet-Shaped

Catalog Number	Tip Size (mm)	Length (in.)
BD845R	0.6	8 3/4
BD846R	0.9	8 3/4



BD850R-BD851R

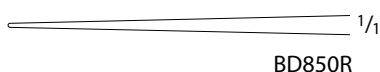

BD850R



BD851R

YASARGIL Micro Forceps,
 Bayonet-Shaped

Catalog Number	Tip Size (mm)	Length (in.)
BD850R	0.6	9 1/2
BD851R	0.9	9 1/2



Gruenwald Micro Forceps,
 Bayonet-Shaped

Catalog Number	Teeth	Length (in.)
BD888R	1 x 2	6 1/4



PENFIELD Watchmaker Forceps

Catalog Number	Length (in.)
MD536R	7



HUNT Grasping Forceps,
 Bayonet-Shaped

Catalog Number	Tip	Shape	Diameter (mm)	Length (in.)
BD765R	ANG	STR	4.5	7 7/8



HUNT Grasping Forceps,
 Bayonet-Shaped

Catalog Number	Tip	Shape	Diameter (mm)	Length (in.)
BD766R	STR	BAYONET	4.5	7 7/8

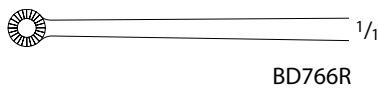

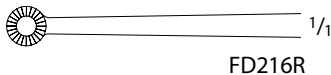
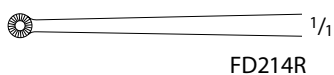
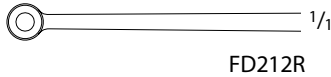
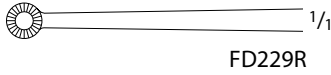
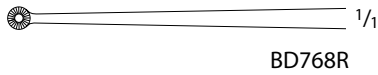

YASARGIL Grasping Forceps,
Bayonet-Shaped

Catalog Number	Tip	Shape	Diameter (mm)	Length (in.)
BD768R	STR	BAYONET	3.0	7 7/8

YASARGIL Micro Forceps,
Bayonet-Shaped

Catalog Number	Diameter (mm)	Length (in.)
FD223R	3.0	7 7/8
FD229R	5.0	7 7/8

YASARGIL Grasping Forceps,
Bayonet-Shaped

Catalog Number	Jaw	Diameter (mm)	Length (in.)
FD210R	SPOON-SHAPED	3.0	8 3/4
FD212R	SPOON-SHAPED	5.0	8 3/4

YASARGIL Grasping Forceps,
Bayonet-Shaped

Catalog Number	Jaw	Diameter (mm)	Length (in.)
FD214R	FLAT/SERR	3.0	8 3/4
FD216R	FLAT/SERR	5.0	8 3/4



FD215R-FD217R

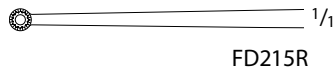

FD215R

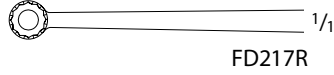

FD217R

HEIFETZ Grasping Forceps,
Bayonet-Shaped

Catalog Number	Jaw	Diameter (mm)	Length (in.)
FD215R	CURETTE, TOOTHED	3.0	8 3/4
FD217R	CURETTE, TOOTHED	5.0	8 3/4



FD200R-FD204R



FD200R

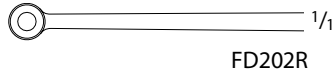

FD202R



FD204R

YASARGIL-SAMII Grasping Forceps,
Bayonet-Shaped

Catalog Number	Jaw	Diameter (mm)	Length (in.)
FD200R	SPOON-SHAPED	3.0	9 1/2
FD202R	SPOON-SHAPED	5.0	9 1/2
FD204R	SPOON-SHAPED	7.0	9 1/2



FD092R-FD093R

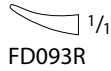
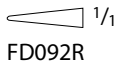

YASARGIL Micro Needle Holder

Catalog Number	Tip	Length (in.)
FD092R	STR	7 7/8
FD093R	CVD-UP	7 7/8



FD096R-FD097R

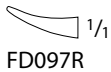
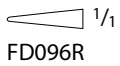

YASARGIL Micro Needle Holder

Catalog Number	Tip	Length (in.)
FD096R	STR	8 7/8
FD097R	CVD-UP	8 7/8



FD120R



Micro Needle Holder

Catalog Number	Tip	Length (in.)
FD120R	CVD-UP	7 3/4



FD701B-FD776B



FD701B, FD704B



FD702B, FD705B



FD703B, FD706B



FD701B-FD703B

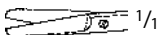

FD704B-FD706B



FD731B, FD734B



FD732B-FD735B



FD733B-FD736B



FD731B-FD733B

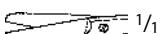

FD734B-FD736B



FD771B, FD774B



FD772B, FD775B



FD773B, FD776B



FD771B-FD773B



FD774B-FD776B

MIN, Noir Micro Scissors W/ Golfball
 Handle, Serrated Blades

Catalog Number	Tip	Blade	Working Length (in.)	Length (in.)
FD701B	S/S	STR	2 3/4	7 7/8
FD702B	S/S	SLIGHT-CVD	2 3/4	7 7/8
FD703B	S/S	CVD	2 3/4	7 7/8
FD704B	B/B	STR	2 3/4	7 7/8
FD705B	B/B	SLIGHT-CVD	2 3/4	7 7/8
FD706B	B/B	CVD	2 3/4	7 7/8
FD731B	S/S	STR	3 1/2	8 3/4
FD732B	S/S	SLIGHT-CVD	3 1/2	8 3/4
FD733B	S/S	CVD	3 1/2	8 3/4
FD734B	B/B	STR	3 1/2	8 3/4
FD735B	B/B	SLIGHT-CVD	3 1/2	8 3/4
FD736B	B/B	CVD	3 1/2	8 3/4
FD771B	S/S	STR	4 3/4	9 3/4
FD772B	S/S	SLIGHT-CVD	4 3/4	9 3/4
FD773B	S/S	CVD	4 3/4	9 3/4
FD774B	B/B	STR	4 3/4	9 3/4
FD775B	B/B	SLIGHT-CVD	4 3/4	9 3/4
FD776B	B/B	CVD	4 3/4	9 3/4



FD717B-FD719B



FD717B-FD719B



FD711B-FD763B



FD711B, FD741B, FD761B



FD711B, FD741B, FD761B



FD713B, FD743B, FD763B

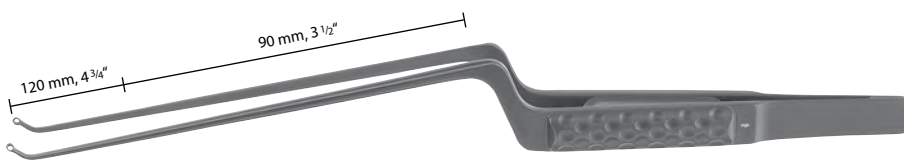

FD767B-FD789B



FD766B, FD769B, FD786B, FD789B



FD767B, FD787B



FD768B, FD788B



FD766B-FD768B, FD786B-FD788B



FD769B, FD789B

MIN, Noir Micro Needle Holder
 W/ Golfball Handle

Catalog Number	Suture Size	Working Length (mm)	Length (in.)
FD717B	7/0 AND SMALLER	70	7 7/8
FD718B	7/0 AND SMALLER	90	8 3/4
FD719B	7/0 AND SMALLER	120	9 3/4

MIN, Noir Micro Tissue Forceps
 W/ Golfball Handle

Catalog Number	Tip	Tip Size (mm)	Working Length (in.)	Length (in.)
FD711B	STR	0.5	2 3/4	7 1/2
FD713B	STR	0.9	2 3/4	7 1/2
FD741B	STR	0.5	3 1/2	8 1/4
FD743B	STR	0.9	3 1/2	8 1/4
FD761B	STR	0.5	4 3/4	9 1/2
FD763B	STR	0.9	4 3/4	9 1/2

MIN, Noir Micro Tumor Forceps
 W/ Golfball Handle

Catalog Number	Tip	Tip Size (mm)	Working Length (in.)	Length (in.)
FD766B	STR	2.5 RING	3 1/2	8 1/4
FD769B	STR	3.5 RING	3 1/2	8 1/4
FD767B	45° CVD	2.5 RING	3 1/2	8 1/4
FD768B	90° CVD	2.5 RING	3 1/2	8 1/4
FD786B	STR	2.5 RING	4 3/4	9 1/2
FD789B	STR	3.5 RING	4 3/4	9 1/2
FD787B	45° CVD	2.5 RING	4 3/4	9 1/2
FD788B	90° CVD	2.5 RING	4 3/4	9 1/2

MIN Set

- Fine instrument tips
- Round golfball handle design
- Various working lengths
- Slender design and angled bayonet-shape
- Noir, No Irritating Reflections



FD811B



FD812B

MIN, Noir Modular Handle F/ Golfball Handle Design

Catalog Number	Diameter (mm)	Length (in.)
FD811B	8	4
FD812B	11	4



FD818B



FD819B



FD848B



FD849B

MIN, Noir Modular Bayonet Handle F/ Golfball Handle Design

Catalog Number	Diameter (mm)	Description	Length (in.)
FD818B	8	LOW BAYONET (21 MM)	4
FD819B	11	LOW BAYONET (31 MM)	4
FD848B	8	HIGH BAYONET (21 MM)	4
FD849B	11	HIGH BAYONET (31 MM)	4

MIN, Noir Micro Probe F/ Modular
 Golfball Handle

Catalog Number	Tip	Length (in.)
FD797B	BALL-TIP 0°	7 7/8
FD798B	BALL-TIP 45°	7 7/8
FD799B	BALL-TIP 90°	7 7/8



MIN, Noir Micro Hook F/ Modular
 Golfball Handle

Catalog Number	Tip	Length (in.)
FD808B	45°, BLUNT	7 7/8
FD805B	90°, BLUNT	7 7/8
FD809B	90°, SHARP	7 7/8



MIN, Noir Micro Scoop F/ Modular
 Golfball Handle

Catalog Number	Tip	Tip Size (mm)	Length (in.)
FD814B	10°	2	7 7/8
FD815B	45°	2	7 7/8
FD816B	45° W/ NECK	2	7 7/8



MIN, Noir Micro Dissector F/ Modular
 Golfball Handle

Catalog Number	Tip	Tip Size (mm)	Length (in.)
FD821B	CVD	1.0	7 7/8
FD822B	CVD	2.0	7 7/8
FD823B	CVD	3.0	7 7/8

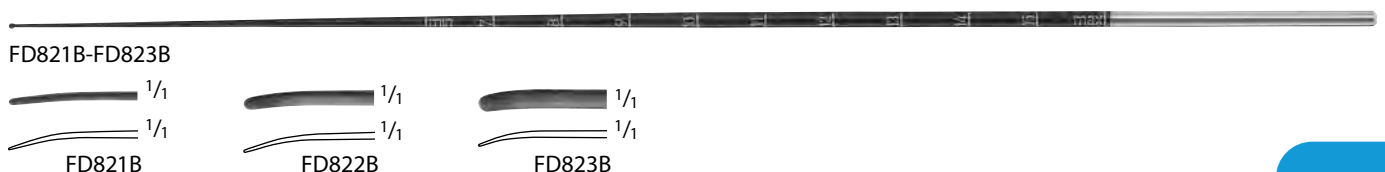

MIN, Noir Micro Raspatory F/ Modular Golfball Handle

Catalog Number	Tip	Tip Size (mm)	Length (in.)
FD831B	RING	DIAM. 1.0	7 7/8
FD832B	RING	DIAM. 2.0	7 7/8
FD833B	RING	DIAM. 3.0	7 7/8



MIN, Noir Micro Tumor Knife F/ Modular Golfball Handle

Catalog Number	Tip	Tip Size (mm)	Length (in.)
FD839B	45°	DIAM. 1.5	7 7/8
FD840B	45°	DIAM. 3.0	7 7/8
FD841B	45°	DIAM. 4.5	7 7/8



MIN, Noir Micro Curette F/ Modular Golfball Handle

Catalog Number	Tip	Diameter (mm)	Length (in.)
FD824B	0°	4.0	7 7/8
FD825B	45°	4.0	7 7/8
FD826B	90°	4.0	7 7/8
FD827B	45° W/ NECK	4.0	7 7/8
FD828B	90° W/ NECK	4.0	7 7/8
FD835B	45°	6.5	7 7/8
FD836B	90°	6.5	7 7/8

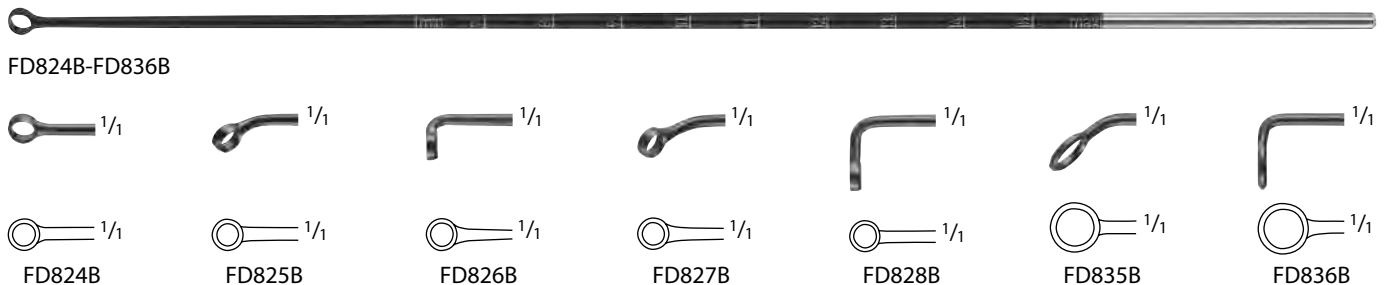

Storage Tray F/ MIN Micro Instruments

Catalog Number	Dimensions (mm)
FD467R	243 x 253 x 56

FD467R



SENSATION Noir Micro Scissors

Catalog Number	Tip	Blade	Working Length (in.)	Length (in.)
FM146B	S/S	CVD-UP	2 3/8	7 1/4



SENSATION Noir Micro Scissors

Catalog Number	Tip	Blade	Working Length (in.)	Length (in.)
FM147B	S/S	CVD-UP	2 3/4	7 3/4



SENSATION Noir Micro Scissors

Catalog Number	Tip	Blade	Working Length (in.)	Length (in.)
FM148B	S/S	CVD-UP	3 1/2	8 1/2

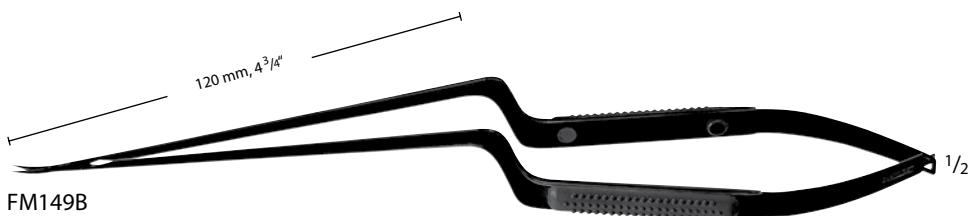

SENSATION Noir Micro Scissors

Catalog Number	Tip	Blade	Working Length (in.)	Length (in.)
FM149B	S/S	CVD-UP	4 3/4	9 5/8

SENSATION Micro Scissors

Catalog Number	Tip	Blade	Handle	Working Length (in.)	Length (in.)
FM120R	S/S	STR	BLUE	2 3/4	7 3/4
FM130R	S/B	STR	BLUE	2 3/4	7 3/4
FM140R	B/B	STR	BLUE	2 3/4	7 3/4

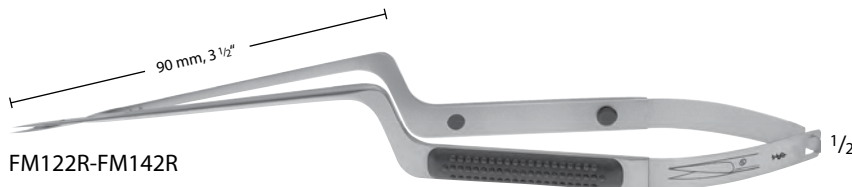
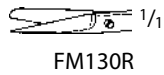
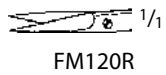

SENSATION Micro Scissors

Catalog Number	Tip	Blade	Handle	Working Length (in.)	Length (in.)
FM122R	S/S	STR	BLUE	3 1/2	8 1/2
FM132R	S/B	STR	BLUE	3 1/2	8 1/2
FM142R	B/B	STR	BLUE	3 1/2	8 1/2

SENSATION Micro Scissors

Catalog Number	Tip	Blade	Handle	Working Length (in.)	Length (in.)
FM124R	S/S	STR	BLUE	4 3/4	9 5/8
FM134R	S/B	STR	BLUE	4 3/4	9 5/8
FM144R	B/B	STR	BLUE	4 3/4	9 5/8

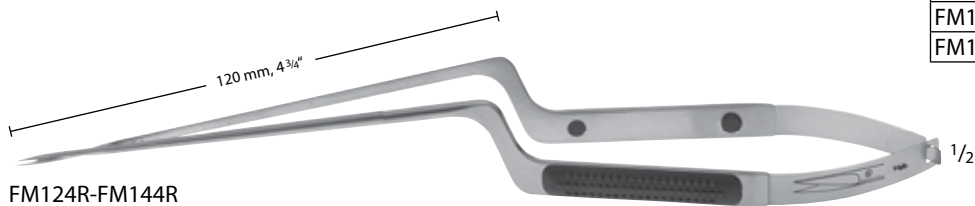

SENSATION Micro Scissors

Catalog Number	Tip	Blade	Handle	Working Length (in.)	Length (in.)
FM159R	S/S	STR	BLUE	5 1/4	10 1/4
FM160R	B/B	STR	BLUE	5 1/4	10 1/4

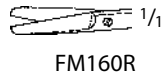
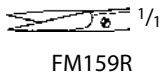
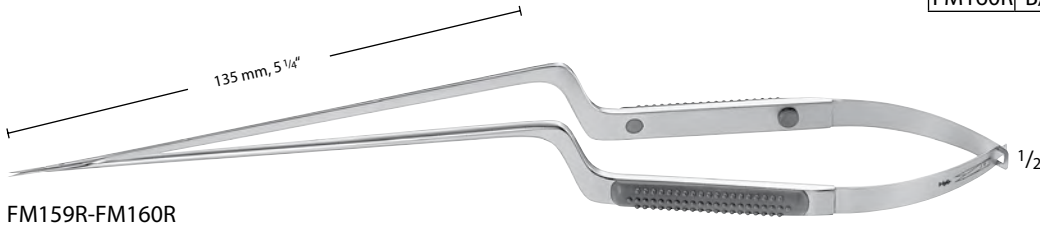

SENSATION Micro Scissors

Catalog Number	Tip	Blade	Handle	Working Length (in.)	Length (in.)
FM121R	S/S	CVD-UP	BLUE	2 3/4	7 3/4
FM131R	S/B	CVD-UP	BLUE	2 3/4	7 3/4
FM141R	B/B	CVD-UP	BLUE	2 3/4	7 3/4

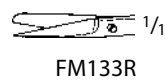
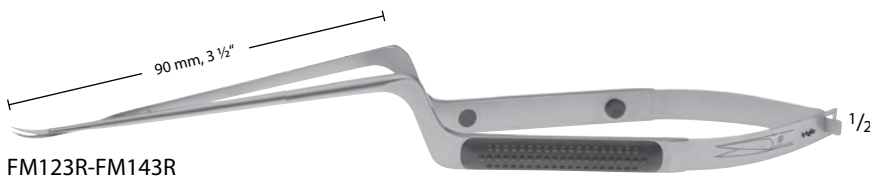

SENSATION Micro Scissors

Catalog Number	Tip	Blade	Handle	Working Length (in.)	Length (in.)
FM123R	S/S	CVD-UP	BLUE	3 1/2	8 1/2
FM133R	S/B	CVD-UP	BLUE	3 1/2	8 1/2
FM143R	B/B	CVD-UP	BLUE	3 1/2	8 1/2

SENSATION Micro Scissors

Catalog Number	Tip	Blade	Handle	Working Length (in.)	Length (in.)
FM125R	S/S	CVD-UP	BLUE	4 3/4	9 5/8
FM135R	S/B	CVD-UP	BLUE	4 3/4	9 5/8
FM145R	B/B	CVD-UP	BLUE	4 3/4	9 5/8

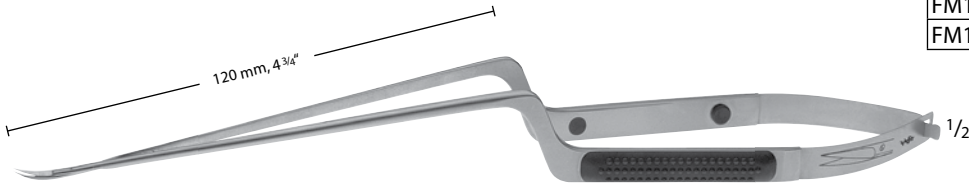

FM125R-FM145R

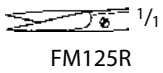

FM125R

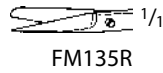

FM135R

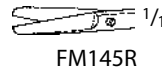

FM145R

SENSATION Micro Scissors

Catalog Number	Tip	Blade	Handle	Working Length (in.)	Length (in.)
FM161R	S/S	CVD-UP	BLUE	5 1/4	10 1/4
FM162R	B/B	CVD-UP	BLUE	5 1/4	10 1/4

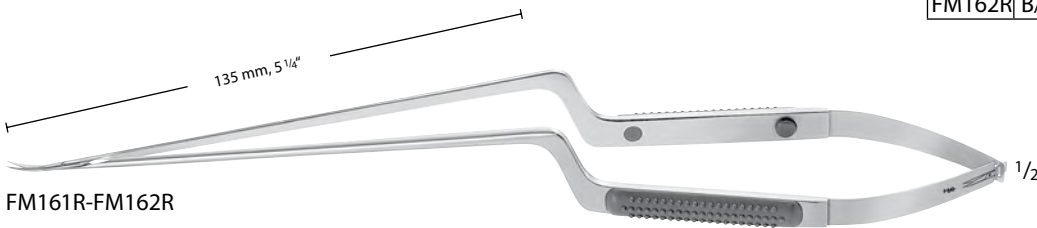

FM161R-FM162R

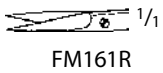

FM161R



FM162R

SENSATION Micro Scissors

Catalog Number	Tip	Blade	Handle	Working Length (in.)	Length (in.)
FM163R	S/S	CVD-DOWN	BLUE	3 1/2	8 1/2
FM164R	B/B	CVD-DOWN	BLUE	3 1/2	8 1/2

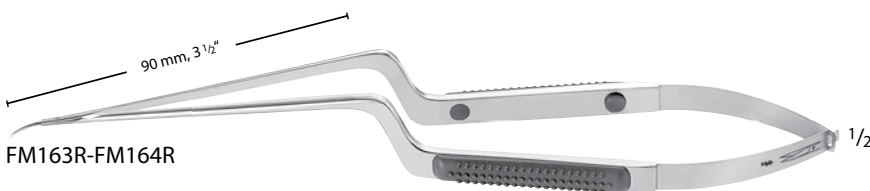

FM163R-FM164R

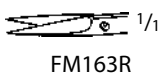

FM163R



FM164R



SENSATION Micro Scissors

Catalog Number	Tip	Blade	Handle	Working Length (in.)	Length (in.)
FM167R	1 BALL-POINT	45° LATERAL ANG	BLUE	3 1/2	8 1/2

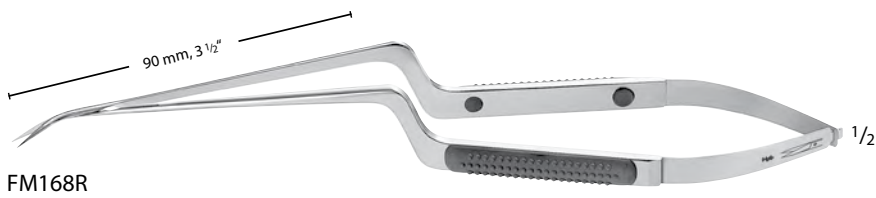

SENSATION Micro Scissors

Catalog Number	Tip	Blade	Handle	Working Length (in.)	Length (in.)
FM168R	B/B	45° LATERAL ANG	BLUE	3 1/2	8 1/2

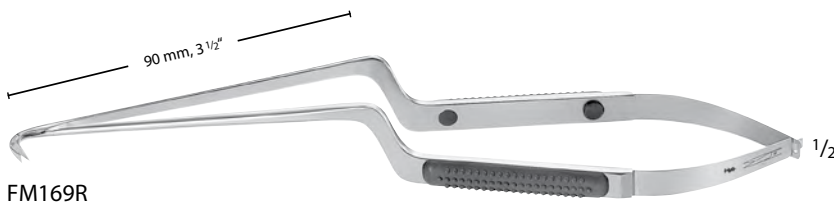

SENSATION Micro Scissors

Catalog Number	Tip	Blade	Handle	Working Length (in.)	Length (in.)
FM169R	B/B	125° LATERAL ANG	BLUE	3 1/2	8 1/2



SENSATION Micro Forceps

Catalog Number	Tip Size (mm)	Handle	Working Length (in.)	Length (in.)
FM150R	0.5	BLACK	2 3/4	7 1/2
FM151R	0.9	BLACK	2 3/4	7 1/2

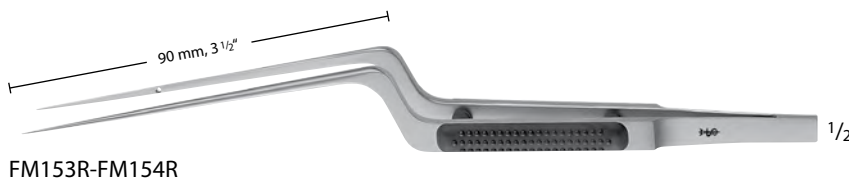

SENSATION Micro Forceps

Catalog Number	Tip Size (mm)	Handle	Working Length (in.)	Length (in.)
FM153R	0.5	BLACK	3 1/2	8 1/4
FM154R	0.9	BLACK	3 1/2	8 1/4

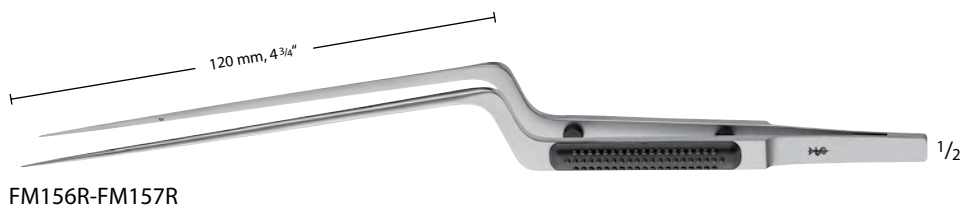

SENSATION Micro Forceps

Catalog Number	Tip Size (mm)	Handle	Working Length (in.)	Length (in.)
FM156R	0.5	BLACK	4 3/4	9 1/2
FM157R	0.9	BLACK	4 3/4	9 1/2

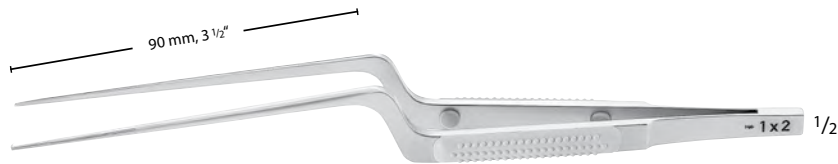

FM174R

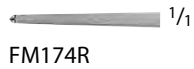

FM174R

SENSATION Tumor Grasper

Catalog Number	Jaw	Teeth	Handle	Working Length (in.)	Length (in.)
FM174R	THIN TOOTH	1 x 2	YELLOW	3 1/2	8 1/4



FM176R-FM177R



FM176R-FM177R

SENSATION Tumor Grasper

Catalog Number	Jaw	Jaw Size (mm)	Handle	Working Length (in.)	Length (in.)
FM176R	SERR	DIAM. 2.5	YELLOW	3 1/2	8 1/4
FM177R	SERR	DIAM. 3.5	YELLOW	3 1/2	8 1/4

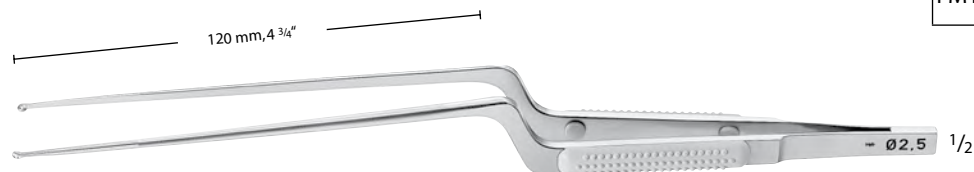

FM178R-FM179R



FM178R-FM179R

SENSATION Tumor Grasper

Catalog Number	Jaw	Jaw Size (mm)	Handle	Working Length (in.)	Length (in.)
FM178R	SERR	DIAM. 2.5	YELLOW	4 3/4	9 1/2
FM179R	SERR	DIAM. 3.5	YELLOW	4 3/4	9 1/2

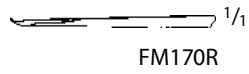

SENSATION Micro Needle Holder

Catalog Number	Jaw Size (mm)	Handle	Working Length (in.)	Length (in.)
FM170R	0.5	GREEN	2 3/4	7 3/4

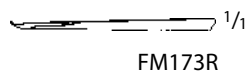

SENSATION Micro Needle Holder

Catalog Number	Jaw Size (mm)	Handle	Working Length (in.)	Length (in.)
FM173R	0.5	GREEN	3 1/2	8 1/2

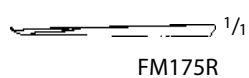

SENSATION Micro Needle Holder

Catalog Number	Jaw Size (mm)	Handle	Working Length (in.)	Length (in.)
FM175R	2.5	GREEN	4 3/4	9 5/8

XS Micro Scissors

Catalog Number	Tip	Blade	Item	Working Length (in.)	Length (in.)
FM670R	S/S	STR	COMPLETE	2 3/4	7 7/8
FM675R	S/S	STR	JAW INSERT	2 3/4	-
FM690R	B/B	STR	COMPLETE	2 3/4	7 7/8
FM695R	B/B	STR	JAW INSERT	2 3/4	-
FM730R	-	-	HANDLE	-	-

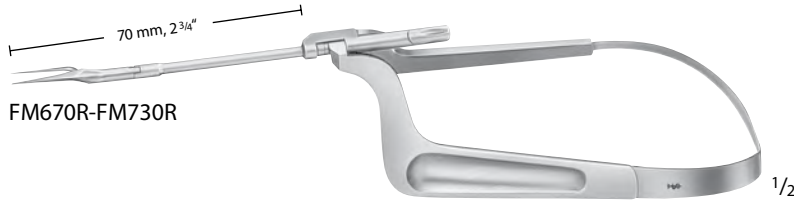

XS Micro Scissors

Catalog Number	Tip	Blade	Item	Working Length (in.)	Length (in.)
FM671R	S/S	STR	COMPLETE	4	9
FM676R	S/S	STR	JAW INSERT	4	-
FM691R	B/B	STR	COMPLETE	4	9
FM696R	B/B	STR	JAW INSERT	4	-
FM731R	-	-	HANDLE	-	-

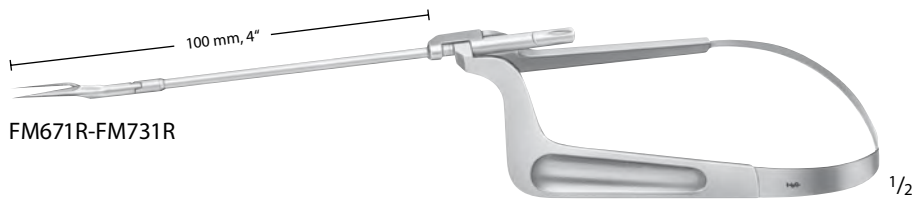

XS Micro Scissors

Catalog Number	Tip	Blade	Item	Working Length (in.)	Length (in.)
FM672R	S/S	STR	COMPLETE	5 1/8	10 1/4
FM677R	S/S	STR	JAW INSERT	5 1/8	-
FM692R	B/B	STR	COMPLETE	5 1/8	10 1/4
FM697R	B/B	STR	JAW INSERT	5 1/8	-
FM732R	-	-	HANDLE	-	-

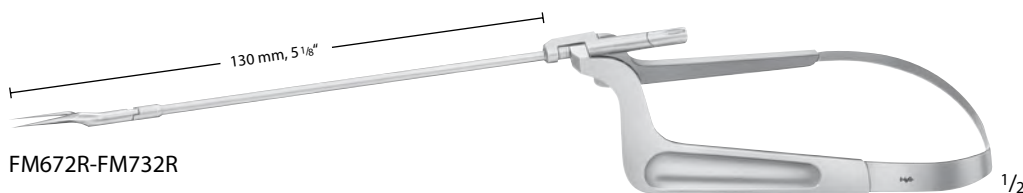

XS Micro Scissors

Catalog Number	Tip	Blade	Item	Working Length (in.)	Length (in.)
FM680R	S/S	CVD	COMPLETE	2 3/4	7 7/8
FM685R	S/S	CVD	JAW INSERT	2 3/4	-
FM700R	B/B	CVD	COMPLETE	2 3/4	7 7/8
FM705R	B/B	CVD	JAW INSERT	2 3/4	-
FM730R	-	-	HANDLE	-	-

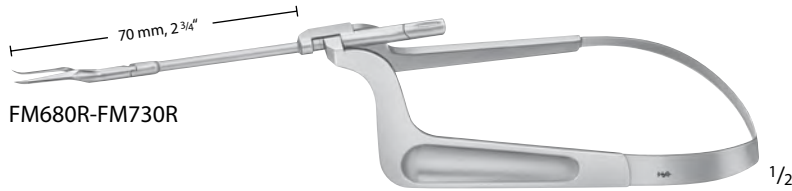

XS Micro Scissors

Catalog Number	Tip	Blade	Item	Working Length (in.)	Length (in.)
FM681R	S/S	CVD	COMPLETE	4	9
FM686R	S/S	CVD	JAW INSERT	4	-
FM701R	B/B	CVD	COMPLETE	4	9
FM706R	B/B	CVD	JAW INSERT	4	-
FM731R	-	-	HANDLE	-	-

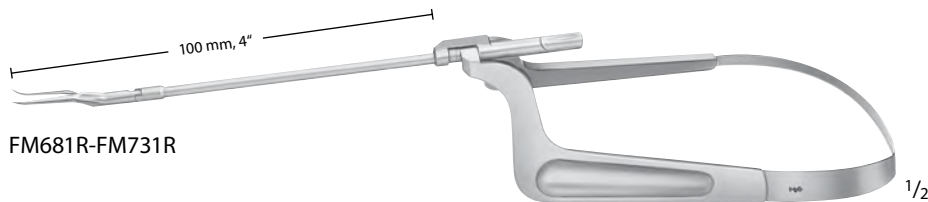

XS Micro Scissors

Catalog Number	Tip	Blade	Item	Working Length (in.)	Length (in.)
FM682R	S/S	CVD	COMPLETE	5 1/8	10 1/4
FM687R	S/S	CVD	JAW INSERT	5 1/8	-
FM702R	B/B	CVD	COMPLETE	5 1/8	10 1/4
FM707R	B/B	CVD	JAW INSERT	5 1/8	-
FM732R	-	-	HANDLE	-	-

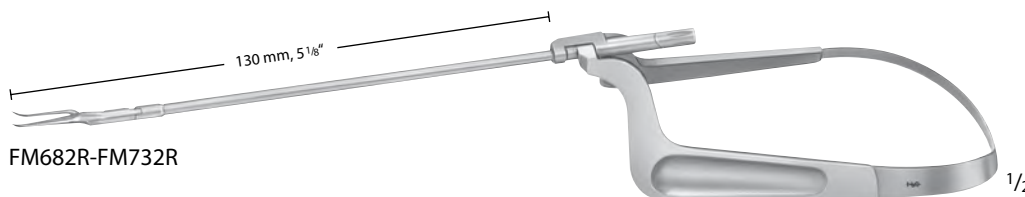

XS Micro Forceps

Catalog Number	Jaw Size (mm)	Item	Working Length (in.)	Length (in.)
FM710R	0.9	COMPLETE	2 3/4	7 7/8
FM715R	0.9	JAW INSERT	2 3/4	-
FM730R	-	HANDLE	-	-



XS Micro Forceps

Catalog Number	Jaw Size (mm)	Item	Working Length (in.)	Length (in.)
FM711R	0.9	COMPLETE	4	9
FM716R	0.9	JAW INSERT	4	-
FM731R	-	HANDLE	-	-

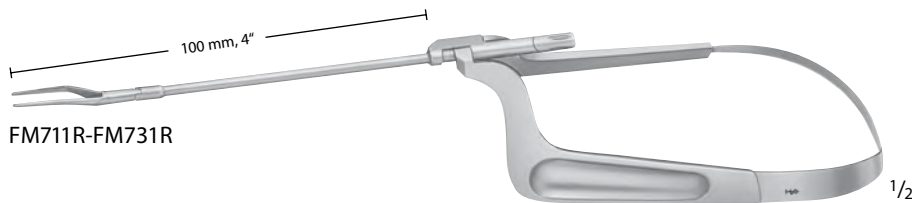

XS Micro Forceps

Catalog Number	Jaw Size (mm)	Item	Working Length (in.)	Length (in.)
FM712R	0.9	COMPLETE	5 1/8	10 1/4
FM717R	0.9	JAW INSERT	5 1/8	-
FM732R	-	HANDLE	-	-

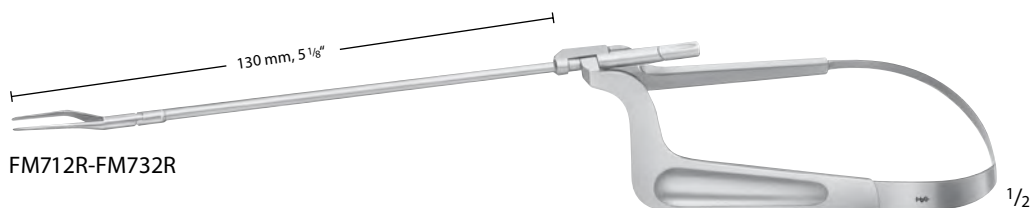

XS Micro Tumor Grasping Forceps

Catalog Number	Jaw Size (mm)	Jaw	Item	Working Length (in.)	Length (in.)
FM720R	3.0	SHARP	COMPLETE	2 3/4	7 7/8
FM725R	3.0	SHARP	JAW INSERT	2 3/4	-
FM730R	-	-	HANDLE	-	-



XS Micro Tumor Grasping Forceps

Catalog Number	Jaw Size (mm)	Jaw	Item	Working Length (in.)	Length (in.)
FM721R	3.0	SHARP	COMPLETE	4	9
FM726R	3.0	SHARP	JAW INSERT	4	-
FM731R	-	-	HANDLE	-	-

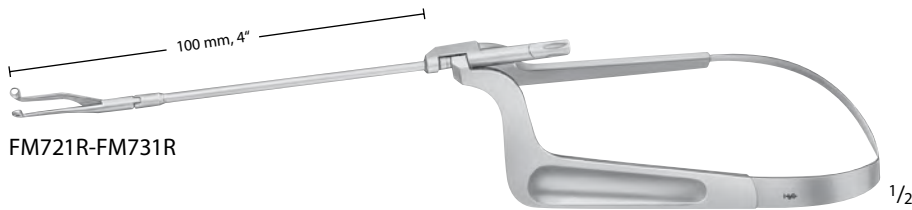

XS Micro Tumor Grasping Forceps

Catalog Number	Jaw Size (mm)	Jaw	Item	Working Length (in.)	Length (in.)
FM722R	3.0	SHARP	COMPLETE	5 1/8	10 1/4
FM727R	3.0	SHARP	JAW INSERT	5 1/8	-
FM732R	-	-	HANDLE	-	-

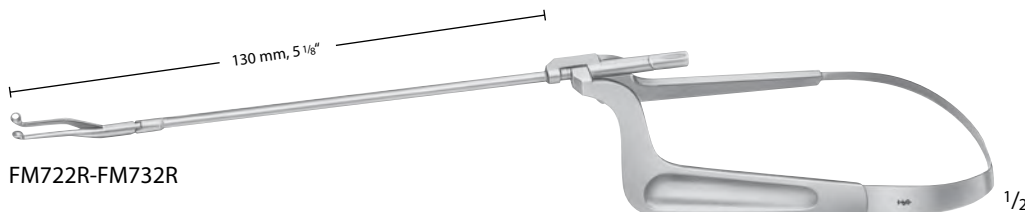



FM665R

Storage Tray for Micro Instruments,
 W/ Instruments Racks

Catalog Number	Compatible w/	Dimensions (mm)
FM665R	SENSATION AND XS MICRO- INSTRUMENTS	406 x 253 x 76

EC/IC Bypass Instruments, Noir Scissors

Catalog Number	Tip	Blade	Shape	Working Length (in.)	Length (in.)
FD482B	S/S	CVD	STR	2	5 1/2
FD481B	B/S	CVD	STR	2	5 1/2
FD483B	S/S	CVD	STR	3 1/8	6 3/4
FD484B	S/S	CVD	BAYONET	4	8 7/8
FD485B	B/S	CVD	BAYONET	4	8 7/8



FD481B-FD482B



FD481B



FD482B



FD483B



FD483B



FD484B-FD485B



FD484B



FD485B



50 mm, 2"

FD488B



FD488B



80 mm, 3 1/8"

FD489B



FD489B



100 mm, 4"

FD490B



FD490B

EC/IC Bypass Instruments, Noir Forceps

Catalog Number	Tip	Tip Size (mm)	Working Length (in.)	Length (in.)
FD488B	STR	0.3	2	5 1/2
FD489B	STR	0.3	3 1/8	6 3/4
FD490B	STR	0.3	4	8 1/4

EC/IC Bypass Instruments, Noir Needle Holder

Catalog Number	Tip	Tip Size (mm)	Working Length (in.)	Length (in.)
FD493B	STR	0.5	2	6
FD494B	CVD	0.5	3 1/8	6 3/4
FD495B	CVD	0.5	4	8 1/4



FD493B

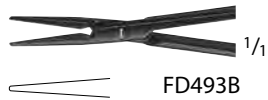

FD494B

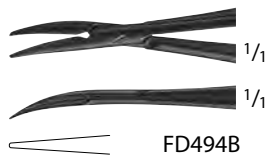

FD495B

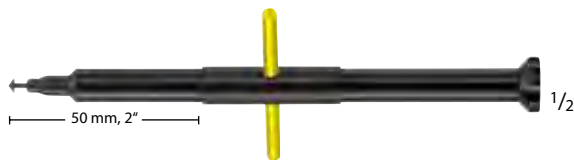

FB194B

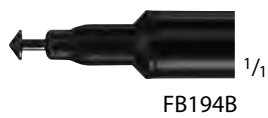

FD460R

EC/IC Bypass Instruments, Noir Bypass Vessel Punch

Catalog Number	Working Length (in.)	Length (in.)
FB194B	2	5 1/2

Storage Rack F/ EC/IC Bypass Instruments

Catalog Number	Dimensions (mm)
FD460R	410 x 257 x 56



FD901R-FD904R



AL-MEFTY Spoon

Catalog Number	Tip	Tip Size (mm)	Handle	Length (in.)
FD901R	STR, SHARP	2.8	BLACK CAP	7 7/8
FD902R	ANG, SHARP	2.8	BLACK CAP	7 7/8
FD903R	STR, SHARP	4.4	BLACK CAP	7 7/8
FD904R	ANG, SHARP	4.4	BLACK CAP	7 7/8



FD911R-FD913R



AL-MEFTY Dissector

Catalog Number	Tip	Tip Size (mm)	Handle	Length (in.)
FD911R	ANG, SHARP	2.0	BLACK CAP	7 7/8
FD912R	ANG, SHARP	3.5	BLACK CAP	7 7/8
FD913R	ANG, SHARP	4.0	BLACK CAP	7 7/8



FD908R-FD910R

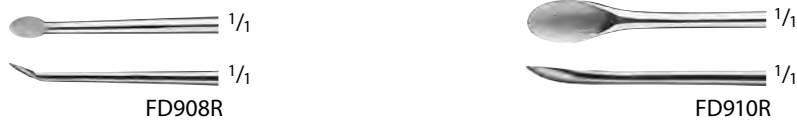

AL-MEFTY Dissector

Catalog Number	Tip	Tip Size (mm)	Handle	Length (in.)
FD908R	ANG, SEMI-SHARP	2.0	GREY CAP	7 7/8
FD909R	ANG, SEMI-SHARP	3.5	GREY CAP	7 7/8
FD910R	STR, SEMI-SHARP	4.0	GREY CAP	7 7/8



FD905R

AL-MEFTY Ligature Needle

Catalog Number	Tip	Length (in.)
FD905R	MALLEABLE	7 1/2

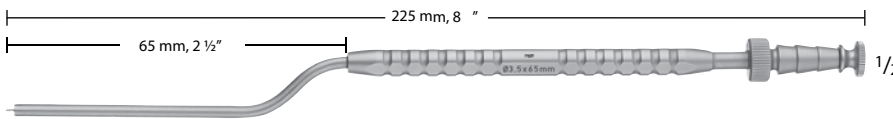

FD906R

AL-MEFTY Suction Cannula

Catalog Number	Working Length (in.)	Diameter (mm)	Length (in.)
FD906R	2 1/2	3.5	8 7/8



FD907R

AL-MEFTY Chisel

Catalog Number	Tip Size (mm)	Length (in.)
FD907R	5.0	8 1/2



MD131

Micro Dissector Set

Catalog Number	Description
MD131	COMPLETE SET

Set Includes:

- 1 Micro dissector storage case MD132R
- 1 Instrument of each MD133-MD148



MD132

Micro Dissector Storage Case

Catalog Number	Dimension (in.)
MD132	10.869 x 8.115 x 0.944



MF363R

Expanded Micro Dissector Storage Case

Catalog Number	Dimension (in.)
MF363R	10.869 x 10.074 x 0.944



MF364R

Expanded Micro Dissector Set

Catalog Number	Description
MF364R	COMPLETE SET

Set Includes:

- 1 Expanded micro dissector storage case MF363R
- 1 Instrument of each MD133-MD148, MF360R-MF362R



Micro Dissector, Round

Catalog Number	Tip Size (mm)	Length (in.)
MD133	1.0	7 1/2



Micro Dissector, Round

Catalog Number	Tip Size (mm)	Length (in.)
MD134	2.0	7 1/2



Micro Dissector, Round

Catalog Number	Tip Size (mm)	Length (in.)
MD135	3.0	7 1/2



Micro Elevator

Catalog Number	Tip	Length (in.)
MD136	CVD	7 1/2

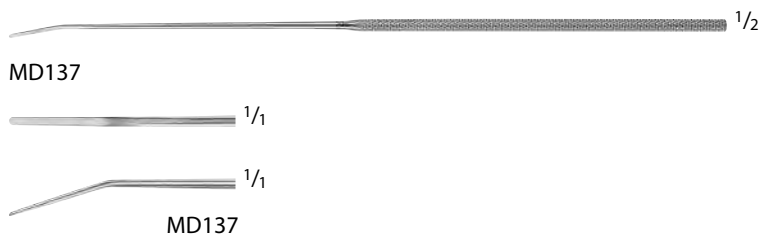

Micro Dissector Elevator

Catalog Number	Tip	Length (in.)
MD137	ANG	7 1/2

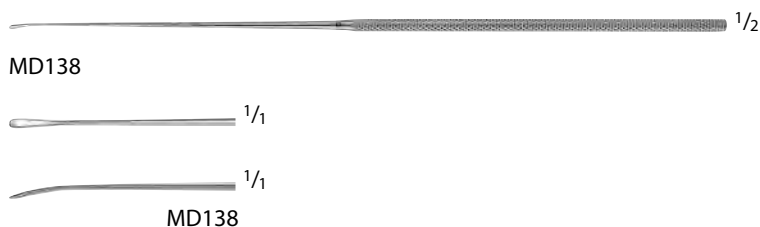

Micro Spatula Dissector

Catalog Number	Tip	Length (in.)
MD138	SMALL	7 1/2



MD141



MD142



MD143



MD144

Micro Spatula Dissector

Catalog Number	Tip	Length (in.)
MD139	MEDIUM	7 1/2

Micro Spatula Dissector

Catalog Number	Tip	Length (in.)
MD140	LARGE	7 1/2

Micro Hook

Catalog Number	Tip	Length (in.)
MD141	90°, SEMI-SHARP	7 1/2

Micro Hook

Catalog Number	Tip	Length (in.)
MD142	90°, BLUNT	7 1/2

Micro Needle Dissector

Catalog Number	Tip	Length (in.)
MD143	45°, SEMI-SHARP	7 1/2

Micro Needle Dissector

Catalog Number	Tip	Length (in.)
MD144	STR, SEMI-SHARP	7 1/2



MD145



MD145



MD146



MD146



MD147



MD147



MD148



MD148



MF360R



MF360R



MF361R



MF361R



MF362R



MF362R

Micro Curette

Catalog Number	Tip	Tip Size (mm)	Length (in.)
MD145	STR	1 x 2	7 1/2

Micro Curette

Catalog Number	Tip	Tip Size (mm)	Length (in.)
MD146	ANG	1 x 2	7 1/2

Micro Ball Dissector

Catalog Number	Tip	Tip Size (mm)	Length (in.)
MD147	90°	3.0	7 1/2

Micro Ball Dissector

Catalog Number	Tip	Tip Size (mm)	Length (in.)
MD148	45°	4.0	7 1/2

Micro Ball Dissector

Catalog Number	Tip	Tip Size (mm)	Length (in.)
MF360R	90°	5.0	7 1/2

Micro Ball Dissector

Catalog Number	Tip	Tip Size (mm)	Length (in.)
MF361R	45°	8.0	7 1/2

Micro Ball Dissector

Catalog Number	Tip	Tip Size (mm)	Length (in.)
MF362R	STR	0.8	7 1/2



Jannetta Style Knife #1

Catalog Number	Diameter (mm)	Length (in.)
MF412R	2.0	7 1/2

Jannetta Style Knife #2

Catalog Number	Diameter (mm)	Length (in.)
MF413R	2.5	7 1/2

Jannetta Style Duckbill Elevator #3

Catalog Number	Width (mm)	Length (in.)
MF414R	2.7	7 1/2

Jannetta Style Elevator #4

Catalog Number	Width (mm)	Length (in.)
MF415R	1.2	7 1/2

Jannetta Style Dissector #5

Catalog Number	Width (mm)	Length (in.)
MF416R	1.6	7 1/2

Jannetta Style Dissector #6

Catalog Number	Width (mm)	Length (in.)
MF417R	2.0	7 1/2

Jannetta Style Right Angle Hook #7

Catalog Number	Tip	Tip Size (mm)	Length (in.)
MF418R	90°	2.0	7 1/2



Jannetta Style Probe #8

Catalog Number	Tip	Tip Size (mm)	Length (in.)
MF419R	45°	1.7	7 1/2



Jannetta Style Right Angle Hook #9

Catalog Number	Tip	Tip Size (mm)	Length (in.)
MF420R	90°	3.5	7 1/2



Jannetta Style Hook #9A

Catalog Number	Tip	Tip Size (mm)	Length (in.)
MF421R	45°	2.8	7 1/2



Jannetta Style Right Angle Hook #10

Catalog Number	Tip	Tip Size (mm)	Length (in.)
MF422R	90°	4.7	7 1/2



Jannetta Style Probe #11

Catalog Number	Tip	Diameter (mm)	Length (in.)
MF423R	BALL-PT	0.8	7 1/2



Jannetta Style Double Prong Fork #12

Catalog Number	Tip	Width (mm)	Length (in.)
MF424R	30°	1.1	7 1/2



Jannetta Style Double Prong Fork #13

Catalog Number	Tip	Width (mm)	Length (in.)
MF425R	30°	1.4	7 1/2



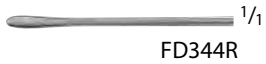
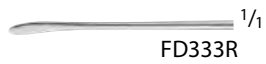

Jannetta Style Aneurysm Neck
 Dissector #14

Catalog Number	Tip	Length (in.)
MF426R	RIGHT	7 1/2

Jannetta Style Aneurysm Neck
 Dissector #15

Catalog Number	Tip	Length (in.)
MF427R	RIGHT	7 1/2

Micro Dissector

Catalog Number	Length (in.)
FD333R	9

Micro Dissector

Catalog Number	Tip	Shape	Length (in.)
FD343R	CVD-UP	BAYONET	9

Micro Dissector

Catalog Number	Tip	Shape	Length (in.)
FD344R	CVD	BAYONET	9

Micro Raspatory

Catalog Number	Tip	Length (in.)
FD338R	PLATE-SHAPED ANG-DOWN	9

Micro Raspatory

Catalog Number	Tip	Shape	Length (in.)
FD346R	PLATE-SHAPED ANG-UP	BAYONET	9



Micro Hook

Catalog Number	Tip	Length (in.)
FD330R	SEMI-SHARP	9

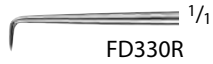

Micro Hook

Catalog Number	Tip	Length (in.)
FD331R	BLUNT	9



Micro Dissector

Catalog Number	Tip	Length (in.)
FD332R	STR	9



Micro Dissector

Catalog Number	Tip	Length (in.)
FD334R	SMALL	9



Micro Scoop

Catalog Number	Tip	Length (in.)
FD335R	STR, SHARP	9



Micro Scoop

Catalog Number	Tip	Length (in.)
FD336R	ANG, SHARP	9



Micro Raspatory

Catalog Number	Tip	Length (in.)
FD337R	ROUND, SMALL	9





FF326R

YASARGIL Dissector, F/ Pediatrics

Catalog Number	Tip Size (mm)	Shaft	Length (in.)
FF326R	4.0	FLEX	7 3/4



FF327R

YASARGIL Dissector, F/ Adults

Catalog Number	Tip Size (mm)	Shaft	Length (in.)
FF327R	7.0	FLEX	7 3/4



FF291R

PENFIELD Dissector, Double Ended

Catalog Number	Tip	Size	Length (in.)
FF291R	SLIGHT-CVD, S/B	#1	6 7/8

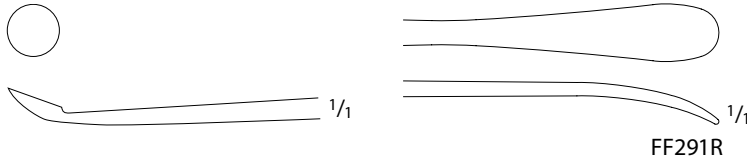

FF291R



FF292R

PENFIELD Dissector, Double Ended

Catalog Number	Tip	Size	Length (in.)
FF292R	SLIGHT-CVD, S/B	#2	7 3/4



FF292R



FF293R

PENFIELD Dissector, Double Ended

Catalog Number	Tip	Size	Length (in.)
FF293R	CVD, S/B	#3	7 3/4

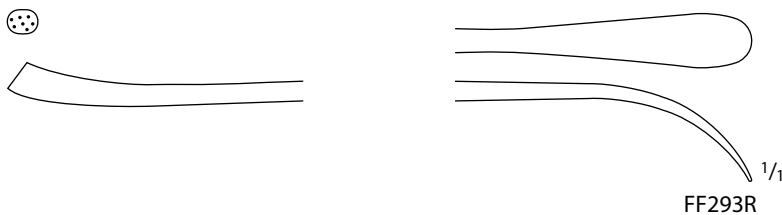

FF293R



FF294R

PENFIELD Dissector

Catalog Number	Tip	Size	Length (in.)
FF294R	SLIGHT-CVD	#4	8

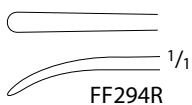

FF294R

PENFIELD Dissector, Double Ended

Catalog Number	Tip	Size	Length (in.)
FF295R	SLIGHT-CVD, B/B	#5	11 1/2



FF295R

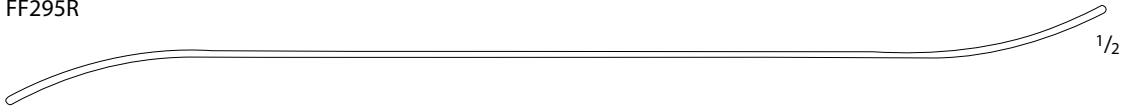

FF295R



FF310R



FF310R



FF303R

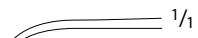

FF303R

CASPAR Micro Dissector

Catalog Number	Tip	Tip Size (mm)	Length (in.)
FF310R	CVD	1.0	7 7/8
FF303R	CVD	4.5	9



FF305R



FF305R

CASPAR Micro Dissector

Catalog Number	Tip	Tip Size (mm)	Shape	Length (in.)
FF307R	CVD-DOWN	2.0	BAYONET	9
FF305R	CVD-DOWN	4.5	BAYONET	9



FF307R



FF307R

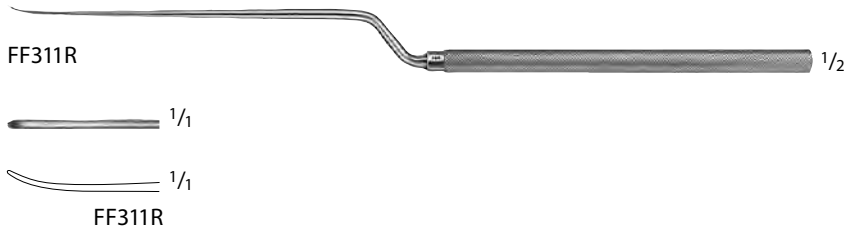

CASPAR Micro Dissector

Catalog Number	Tip	Tip Size (mm)	Shape	Length (in.)
FF311R	CVD-UP	1.0	BAYONET	8 1/4
FF312R	CVD-DOWN	1.0	BAYONET	8 1/4



MILLIGAN Dissector, Double Ended

Catalog Number	Tip	Tip Size (mm)	Length (in.)
MF455R	S/B	7.8	8 3/4

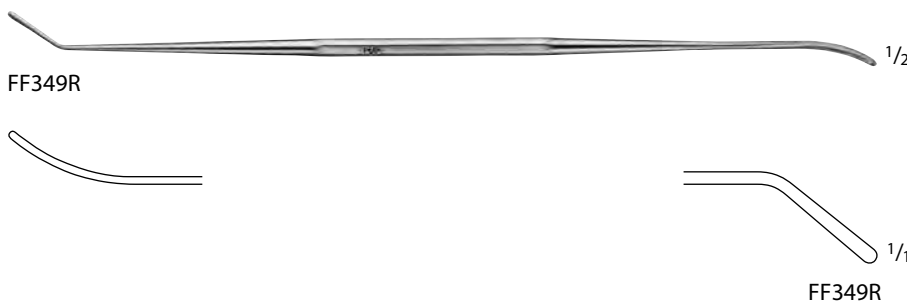

PENNYBACKER Probe Dissector, Double Ended

Catalog Number	Tip	Length (in.)
FF349R	SLIGHT-CVD	9

WOODSON Elevator, Spatula, Double Ended

Catalog Number	Tip	Length (in.)
MD605	DBL-END	10

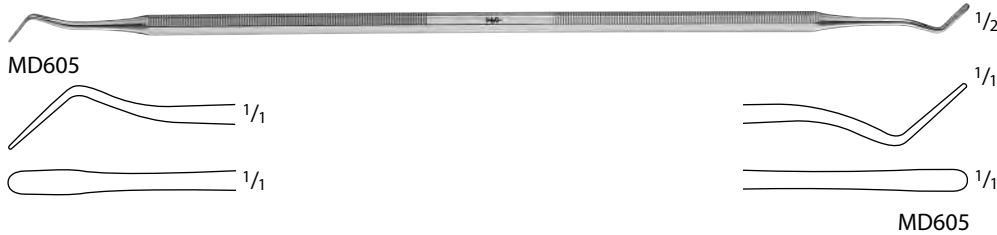

DAVIS Vascular Spatula, Double Ended

Catalog Number	Tip	Length (in.)
FF300R	SLIGHT-CVD, B/B	9 5/8



TOENNIS Vascular Spatula, Double Ended

Catalog Number	Tip	Tip Size (mm)	Length (in.)
FF301R	SLIGHT-CVD, B/B	3 + 4	9 1/2
FF302R	SLIGHT-CVD, B/B	5 + 6	9 1/2



MUELLER Dura Hook

Catalog Number	Tip	Length (in.)
OL626R	1 PRONG	6

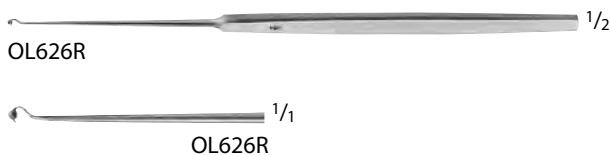



OL627R

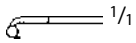

OL627R



FF313R



FF313R



FF321R



FF321R



FF322R



FF322R



FL711R

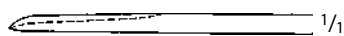

FL711R

MUELLER Dura Hook

Catalog Number	Tip	Length (in.)
OL627R	2 PRONGS	6

CAIRNS Dura Retractor

Catalog Number	Tip	Length (in.)
FF313R	ANG SHARP	5 1/8

FRAZIER Dura Retractor

Catalog Number	Tip	Length (in.)
FF321R	CVD SHARP	5 1/8

TOENNIS Dura Retractor

Catalog Number	Tip	Length (in.)
FF322R	CVD SHARP	6

KRAEMER Osteophyte Chisel

Catalog Number	Tip Size (mm)	Length (in.)
FL711R	2.5	8 1/2

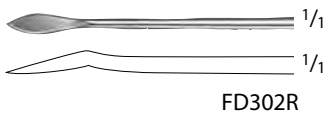
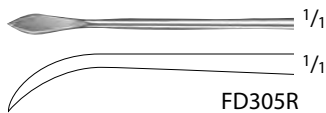
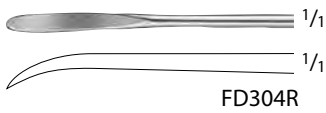
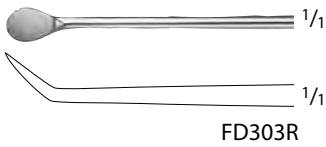
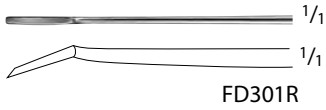

YASARGIL Micro Raspatory

Catalog Number	Tip	Shape	Length (in.)
FD301R	ANG-UP	STR	7 1/4
FD303R	ANG-UP	STR	7 1/4
FD304R	SLIGHT-CVD	STR	7 1/4
FD305R	HEAVY-CVD	STR	7 1/4

YASARGIL Micro Dissector

Catalog Number	Tip	Shape	Length (in.)
FD302R	ANG-UP	STR	7 1/4

YASARGIL Micro Raspatory

Catalog Number	Tip	Shape	Length (in.)
FD320R	CVD	BAYONET	7 1/4
FD321R	CVD	BAYONET	7 1/4
FD322R	CVD-UP	BAYONET	7 1/4



Twist Hook Tissue Pick

Catalog Number	Tip	Length (in.)
FD392R	1.8	7 1/4



FISCH Hook, Sharp

Catalog Number	Tip	Length (in.)
FD376R	90°	7 1/4



Dura Hook, Sharp

Catalog Number	Tip	Length (in.)
FD375R	90°	7 1/4

CASPAR Exploration Hook, Probe-End

Catalog Number	Tip	Length (in.)
BT088R	90° SHORT	9 5/8
BT089R	90° MEDIUM	9 5/8
BT090R	90° LONG	9 5/8
BT091R	45°	9 5/8



MCCULLOCH Probe

Catalog Number	Tip	Tip Size (mm)	Length (in.)
MB310R	-	COMPLETE SET	-
MB322R	ANG HOOK	2	9 1/2
MB323R	ANG HOOK	3	9 1/2
MB325R	ANG HOOK	5	9 1/2
MB328R	ANG BALL	4	9 1/2
MB335R	ANG BALL	7	9 1/2
MB320R	ANG BALL	8	9 1/2
MB326R	FORAMINAL	17	9 1/2



MB310R Includes:

1 Probe of each MB320R, MB322R, MB323R, MB325R, MB326R





MURPHY Ball Hook

Catalog Number	Tip	Length (in.)
MD557R	HEAVY-CVD	9 1/4



CUSHING Dura Hook

Catalog Number	Length (in.)
MF145R	5 3/4



CUSHING Vessel Hook

Catalog Number	Tip Size (mm)	Tip	Length (in.)
BT082R	1 x 4	BLUNT	7 1/2
BT083R	1 x 7	BLUNT	7 1/2
BT084R	1 x 6	BLUNT	11



CRILE Vessel Hook

Catalog Number	Tip Size (mm)	Tip	Length (in.)
BT080R	1.5 x 9	BLUNT	7 7/8

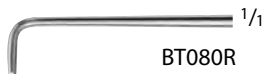

MALIS Style Nerve Hook

Catalog Number	Tip	Tip Size (mm)	Length (in.)
MF143R	BLUNT	2.0	7
MF144R	BLUNT	3.0	7
MF142R	BALL-POINT	3.0	7

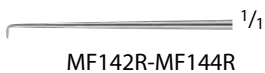

KRAYENBUEHL Nerve Hook

Catalog Number	Tip	Length (in.)
FD396R	SHORT BALL-POINT	7 1/4
FD397R	BALL-POINT	7 1/4
FD398R	BLUNT	7 1/4
FD399R	BLUNT	7 1/4





DANDY Nerve Hook

Catalog Number	Tip Size (mm)	Blade End	Length (in.)
MD562	1 x 8	BLUNT	8 3/4



WEARY Nerve Hook

Catalog Number	Color	Length (in.)
MF138R	BLACK	8

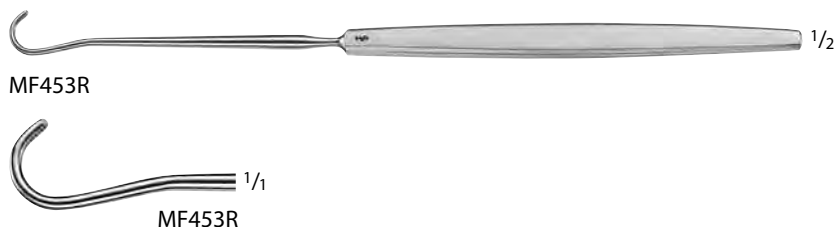

SMITHWICK Nerve Hook

Catalog Number	Length (in.)
MF453R	8 1/4



SMITHWICK Nerve Hook and Dissector, Double Ended

Catalog Number	Length (in.)
MF454R	12 1/4



ADSON Nerve Hook

Catalog Number	Tip	Length (in.)
FD394R	BLUNT	7 1/2
FD395R	SHARP	7 1/2



FD270R-FD273R



FD270R



FD272R

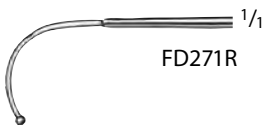

FD271R



FD273R



FD262R

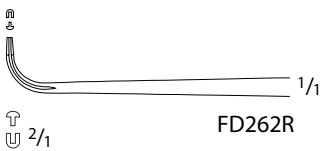

FD262R

YASARGIL Ligature Guide, W/ Ball Point

Catalog Number	Tip	Length (in.)
FD270R	CVD-LEFT	7 1/4
FD271R	CVD	7 1/4
FD272R	HEAVY-CVD	7 1/4
FD273R	90°	7 1/4

YASARGIL Ligature Forceps

Catalog Number	Tip	Shape	Length (in.)
FD262R	TOOTHED	BAYONET	7



FF309



FF309

CASPAR Suture Pusher

Catalog Number	Shape	Length (in.)
FF309	BAYONET	9

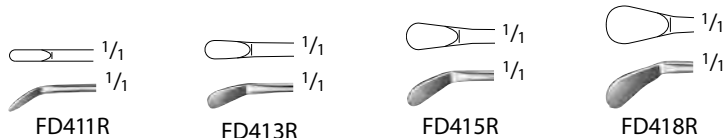

HOEN Dural Separator

Catalog Number	Tip	Depth (mm)	Width (mm)	Length (in.)
MF324R	90°	15	3.0	5 1/2
MF325R	45°	15	3.0	6

DORSEY Dural Separator

Catalog Number	Depth (mm)	Width (mm)	Length (in.)
MF146R	15	5.0	6

FRAZIER Dural Separator

Catalog Number	Depth (mm)	Width (mm)	Length (in.)
MF147R	13	3.0	6

HORSLEY Dural Separator

Catalog Number	Depth (mm)	Width (mm)	Length (in.)
MF148R	55	6.5	8 1/4

WOODSON Dural Separator, Double Ended

Catalog Number	Length (in.)
MF056R	7

SAMII Knives for Tumor Tissue

Catalog Number	Tip Size (mm)	Length (in.)
FD410R	1.0	9
FD411R	1.5	9
FD412R	2.0	9
FD413R	2.5	9
FD414R	3.0	9
FD415R	3.5	9
FD416R	4.0	9
FD418R	5.0	9

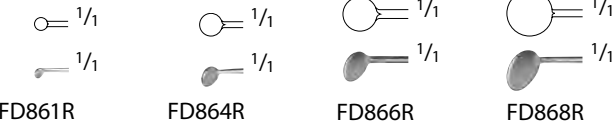

SAMII Tumor Tissue Knife, Round Blade

Catalog Number	Diameter (mm)	Length (in.)
FD861R	1.5	9
FD864R	3.0	9
FD866R	4.5	9
FD868R	6.0	9

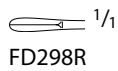

SAMII Lancet Knife

Catalog Number	Length (in.)
FD298R	9



CASPAR Micro Knife

Catalog Number	Tip	Shape	Length (in.)
FD347R	BLUNT	STR	7 7/8

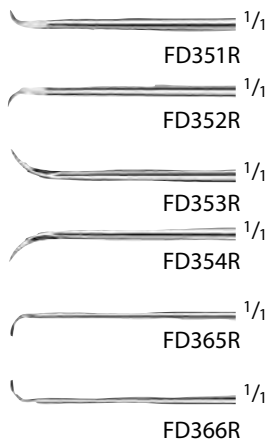

KOOS Micro Vessel Knife,
 Bayonet-Shaped

Catalog Number	Tip	Length (in.)
FD351R	CVD-UP	7 1/4
FD352R	CVD-DOWN	7 1/4
FD353R	SLIGHT CVD-UP	7 1/4
FD354R	SLIGHT CVD-DOWN	7 1/4
FD365R	STRONG CVD-DOWN	7 1/4
FD366R	STRONG CVD-UP	7 1/4



JACOBSON Vessel Knife

Catalog Number	Length (in.)
FD350R	7 1/4



FD113D



FD113D

Diamond Knife

Catalog Number	Tip	Blade	Handle Color	Length (in.)
FD113D	7 FACETS	ROUND	GOLD	8



FD114D



FD114D

Diamond Knife

Catalog Number	Tip	Blade	Handle Color	Length (in.)
FD114D	60°	RETRO	COPPER	8



FD115D



FD115D

Diamond Knife

Catalog Number	Tip	Blade	Handle Color	Length (in.)
FD115D	45°	WEDGE	BLACK	8



FD116D



FD116D

Diamond Knife

Catalog Number	Tip	Blade	Handle Color	Length (in.)
FD116D	60°	LANCET	BRONZE	8



OK100R-OK102R



OK103R

CUSHING-LANDOLT Transsphenoidal Speculum

Catalog Number	Blade Size (mm)	Length (in.)
OK100R	70 x 15	-
OK101R	90 x 15	-
OK102R	110 x 15	-
OK103R	SPREADER FOR OK100R-OK102R	8 1/4



MF130R-MF132R

KILLIAN Speculum, Self Retaining

Catalog Number	Blade Size (mm)
MF130R	51 x 7
MF131R	76 x 7
MF132R	90 x 7

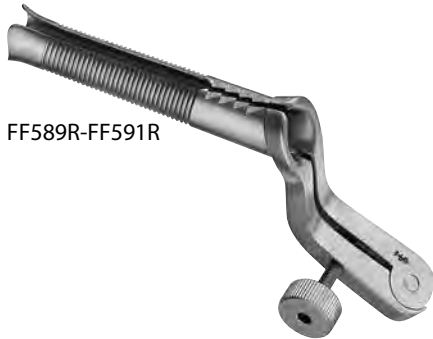

FF589R-FF591R

PAPAVERO-HARTMANN (CASPAR)
Transsphenoidal Speculum, Slim,
W/ Key

Catalog Number	Blade Size (mm)	Description	Length (in.)
FF589R	80 x 11	-	-
FF590R	90 x 13	-	-
FF591R	100 x 15	-	-
TE749R	-	HEX KEY	-
FF595R	34 x 9	SPREADER FOR FF589R-FF591R	5 1/2



TE749R



FF595R

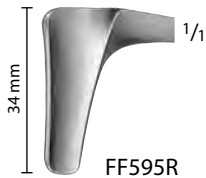

FF595R

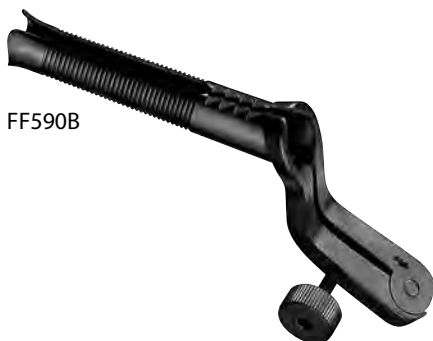

FF590B

Noir Transsphenoidal Specula

Catalog Number	Blade Size (mm)
FF590B	90 x 13



MF137R

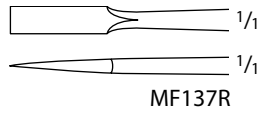

MF137R

PAPAVERO Chisel

Catalog Number	Tip	Tip Size (mm)	Shape	Length (in.)
MF137R	STR	4.0	BAYONET	9



FF611R-FF614R



FF611R



FF614R

RAY Curette

Catalog Number	Tip	Diameter (mm)	Length (in.)
FF611R	HORIZONTAL 45°	4.0	7
FF614R	VERTICAL 45°	4.0	7

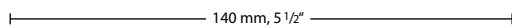

FF616R-FF618R



FF616R



FF617R



FF618R

NICOLA Curette, Malleable, Bayonet-Shaped

Catalog Number	Tip	Diameter (mm)	Working Length (in.)	Length (in.)
FF616R	CUT-RIGHT	6.5	5 1/2	10 1/4
FF617R	CUT-LEFT	6.5	5 1/2	10 1/4
FF618R	-	6.5	5 1/2	10 1/4

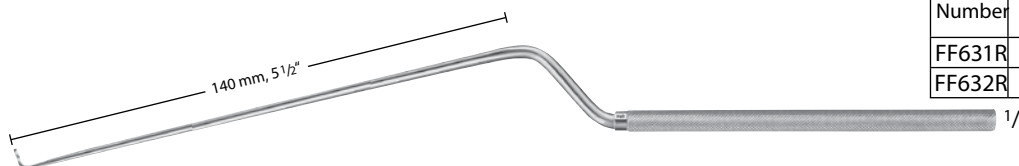

FF631R-FF632R



1/1

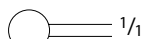

1/1



FF631R



1/1

FF632R

HARDY Curette, Malleable, Bayonet-Shaped

Catalog Number	Diameter (mm)	Working Length (in.)	Length (in.)
FF631R	4.0	5 1/2	10 1/4
FF632R	6.0	5 1/2	10 1/4



NICOLA Raspatory, Bayonet-Shaped

Catalog Number	Length (in.)
FF619R	8 3/4

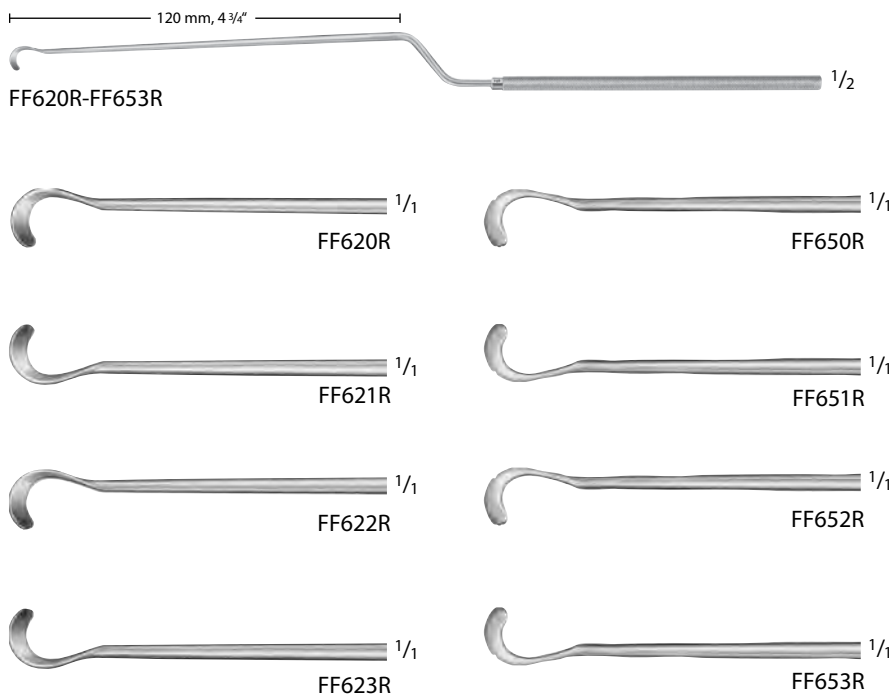

HARDY Enucleator, Bayonet-Shaped

Catalog Number	Tip	Working Length (in.)	Length (in.)
FF620R	CVD-RIGHT, CUT-RIGHT, BLUNT	4 3/4	9 5/8
FF621R	CVD-LEFT, CUT-RIGHT, BLUNT	4 3/4	9 5/8
FF622R	CVD-RIGHT, CUT-RIGHT, SHARP	4 3/4	9 5/8
FF623R	CVD-LEFT, CUT-RIGHT, SHARP	4 3/4	9 5/8
FF650R	CVD-RIGHT, CUT-LEFT, BLUNT	4 3/4	9 5/8
FF651R	CVD-LEFT, CUT-LEFT, BLUNT	4 3/4	9 5/8
FF652R	CVD-RIGHT, CUT-LEFT, SHARP	4 3/4	9 5/8
FF653R	CVD-LEFT, CUT-LEFT, SHARP	4 3/4	9 5/8

Let Us know if you could not find what you are looking for

HARDY-FAHLBUSCH Dissector,
Bayonet-Shaped

Catalog Number	Tip	Working Length (in.)	Length (in.)
FF608R	CVD-RIGHT, CUT-LEFT, SHARP	4 3/4	9 5/8
FF609R	CVD-LEFT, CUT-RIGHT, SHARP	4 3/4	9 5/8

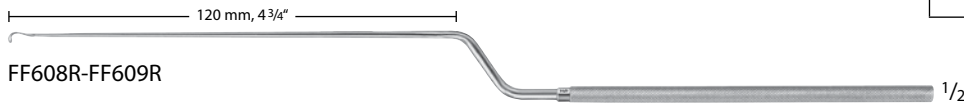

HARDY Implant Fork, Bayonet-Shaped

Catalog Number	Working Length (in.)	Length (in.)
FF624R	4 3/4	9 5/8



NICOLA Curette

Catalog Number	Tip	Diameter (mm)	Handle	Working Length (in.)	Length (in.)
FA030R	VERTICAL 45°	6.5	STR	5 1/2	10 1/2
FA031R	HORIZONTAL 45°	6.5	STR	5 1/2	10 1/2

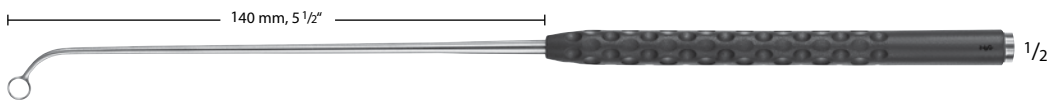

HARDY Enucleator

Catalog Number	Tip	Handle	Working Length (in.)	Length (in.)
FA032R	CVD-LEFT, CUT-LEFT	STR	5 1/2	10 1/2
FA033R	CVD-LEFT, CUT-RIGHT	STR	5 1/2	10 1/2



FA032R-FA033R



FA032R



FA033R

HARDY Curette

Catalog Number	Tip	Diameter (mm)	Handle	Working Length (in.)	Length (in.)
FA036R	45° SHORT NECK	4.0	STR	5 1/2	10 1/2
FA034R	90° LONG NECK	4.0	STR	5 1/2	10 1/2
FA035R	90° SHORT NECK	4.0	STR	5 1/2	10 1/2
FA037R	90° LONG NECK	6.0	STR	5 1/2	10 1/2
FA038R	90° SHORT NECK	6.0	STR	5 1/2	10 1/2



FA034R-FA038R



FA034R



FA036R



FA035R



FA037R



FA038R

LANDOLT-REULEN Hook

Catalog Number	Diameter (mm)	Handle	Working Length (in.)	Length (in.)
FA039R	1.7	STR	5 1/2	10 1/2



FA039R



FA039R

LANDOLT-REULEN Dissector

Catalog Number	Diameter (mm)	Handle	Working Length (in.)	Length (in.)
FA040R	2.0	STR	5 1/2	10 1/2



NICOLA Curette, Bayonet-Shaped

Catalog Number	Tip	Diameter (mm)	Working Length (in.)	Length (in.)
FA041R	VERTICAL 45°	6.5	5 1/8	11
FA042R	HORIZONTAL 45°	6.5	5 1/8	11

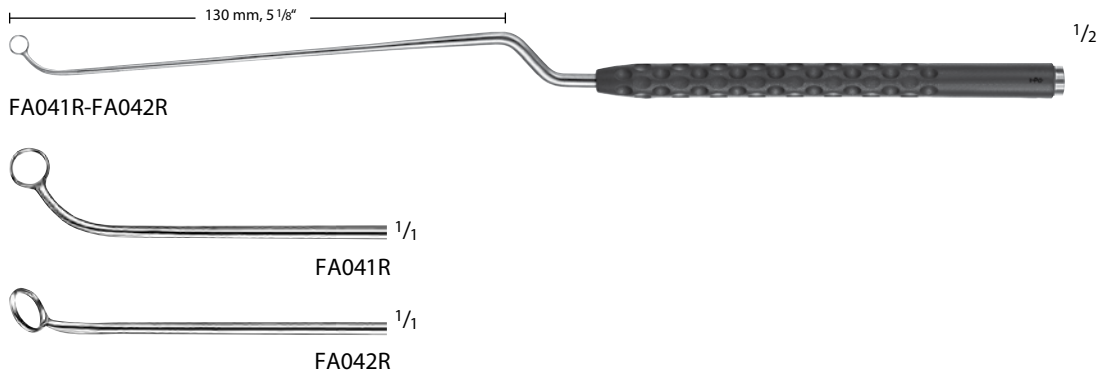

HARDY Enucleator, Bayonet-Shaped

Catalog Number	Tip	Working Length (in.)	Length (in.)
FA043R	CVD-LEFT, CUT-LEFT	5 1/8	11
FA044R	CVD-LEFT, CUT-RIGHT	5 1/8	11

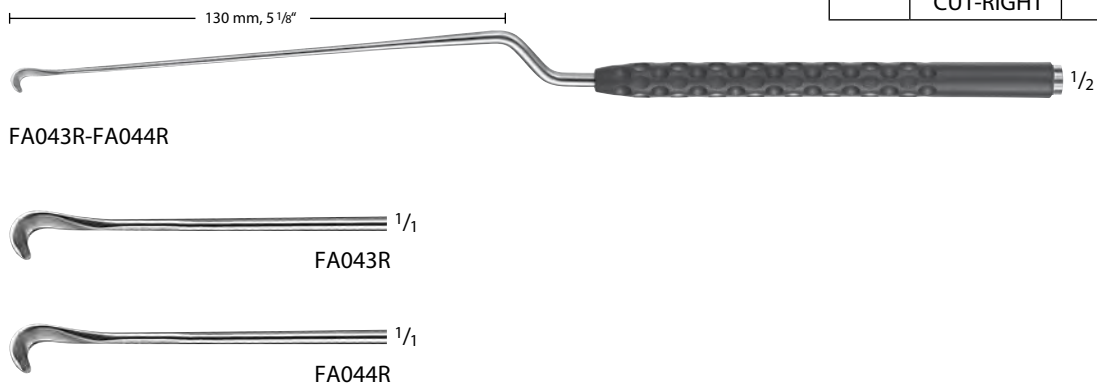

HARDY Curette, Bayonet-Shaped

Catalog Number	Tip	Diameter (mm)	Working Length (in.)	Length (in.)
FA045R	90° LEFT/ LONG NECK	4.0	5 1/8	11
FA046R	90° LEFT/ SHORT NECK	4.0	5 1/8	11
FA047R	90° RIGHT/ LONG NECK	4.0	5 1/8	11
FA060R	90° RIGHT/ SHORT NECK	4.0	5 1/8	11
FA061R	45° LEFT HORIZONTAL/ SHORT NECK	4.0	5 1/8	11
FA062R	45° RIGHT HORIZONTAL/ SHORT NECK	4.0	5 1/8	11
FA063R	90° LEFT/ LONG NECK	6.0	5 1/8	11
FA064R	90° LEFT/ SHORT NECK	6.0	5 1/8	11
FA065R	90° RIGHT/ LONG NECK	6.0	5 1/8	11
FA066R	90° RIGHT/ SHORT NECK	6.0	5 1/8	11

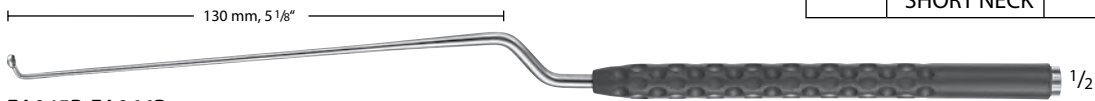

FA045R-FA066R



FA045R



FA062R



FA046R



FA063R



FA047R



FA064R



FA060R 1/1



FA065R



FA061R



FA066R

LANDOLT-REULEN Hook,
Bayonet-Shaped

Catalog Number	Diameter (mm)	Working Length (in.)	Length (in.)
FA067R	1.7	5 1/8	11

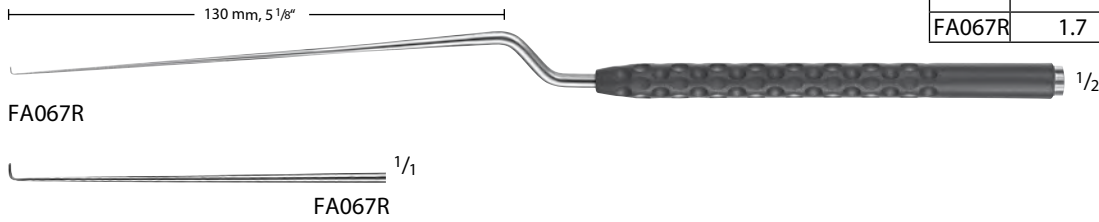

LANDOLT-REULEN Dissector,
Bayonet-Shaped

Catalog Number	Diameter (mm)	Working Length (in.)	Length (in.)
FA068R	2.0	5 1/8	11

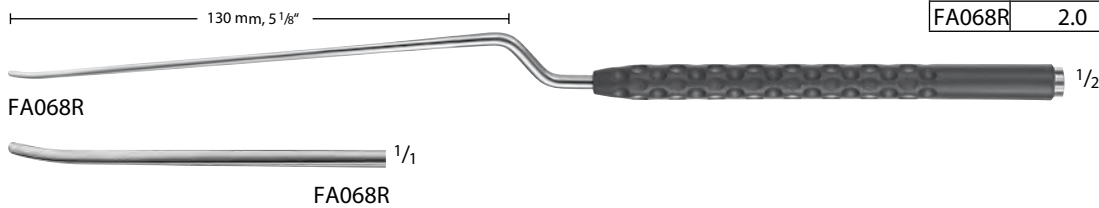

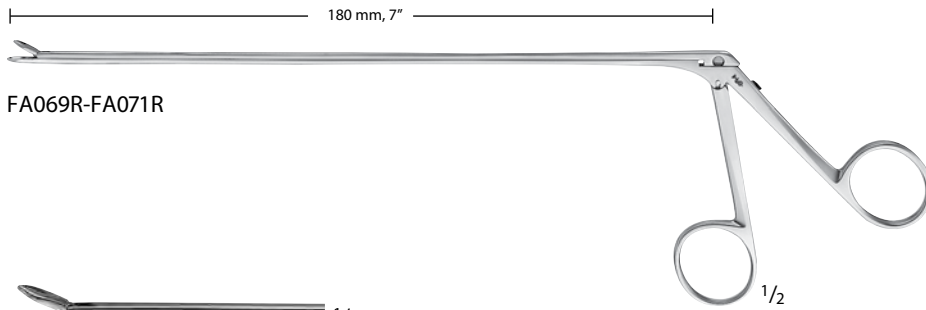

FA069R-FA071R

Micro Forceps

Catalog Number	Blade	Length (in.)
FA069R	STR	7
FA070R	CVD-RIGHT	7
FA071R	CVD-LEFT	7



FA069R



FA070R

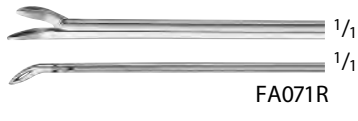

FA071R

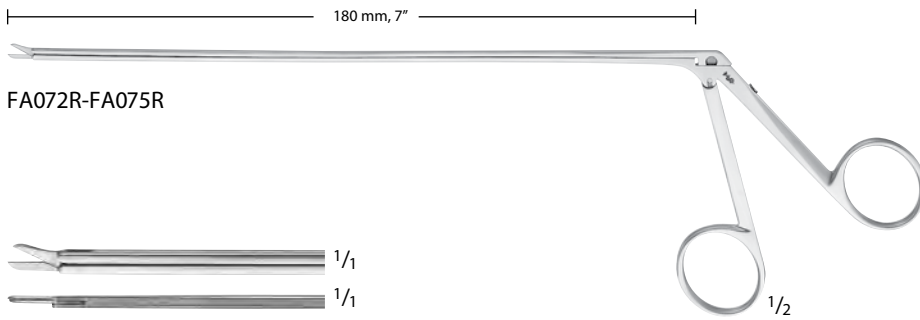

FA072R-FA075R

Micro Scissors

Catalog Number	Blade	Length (in.)
FA072R	STR	7
FA073R	CVD-LEFT	7
FA074R	CVD-RIGHT	7
FA075R	ANG	7



FA072R



FA073R



FA074R



FA075R

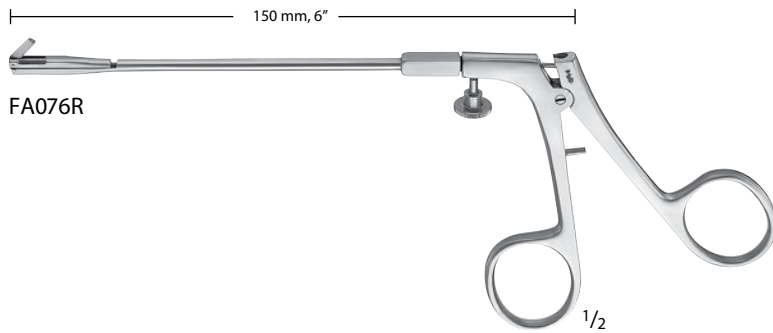

Antrum Punch, Backwards Cutting

Catalog Number	Shaft	Working Length (in.)	Length (in.)
FA076R	ROTATABLE 360°	4 3/4	6



Rotatable Ring Curette

Catalog Number	Tip	Tip Size (mm)	Length (in.)
MF112R	45°, BLUNT	2.0	10 1/2
MF113R	45°, BLUNT	3.0	10 1/2
MF114R	45°, BLUNT	4.0	10 1/2
MF115R	45°, BLUNT	5.0	10 1/2
MF116R	90°, BLUNT	2.0	10 1/2
MF117R	90°, BLUNT	3.0	10 1/2
MF118R	90°, BLUNT	4.0	10 1/2
MF119R	90°, BLUNT	5.0	10 1/2
MF120R	90°, BLUNT	6.0	10 1/2
MF121R	45°, SHARP	2.0	10 1/2
MF122R	45°, SHARP	3.0	10 1/2
MF123R	45°, SHARP	4.0	10 1/2
MF124R	45°, SHARP	5.0	10 1/2
MF125R	90°, SHARP	2.0	10 1/2
MF126R	90°, SHARP	3.0	10 1/2
MF127R	90°, SHARP	4.0	10 1/2
MF128R	90°, SHARP	5.0	10 1/2

LANDOLT Spatula, Bayonet-Shaped

Catalog Number	Shaft	Working Length (in.)	Length (in.)
FF627R	MALLEABLE	6 1/8	10 1/4

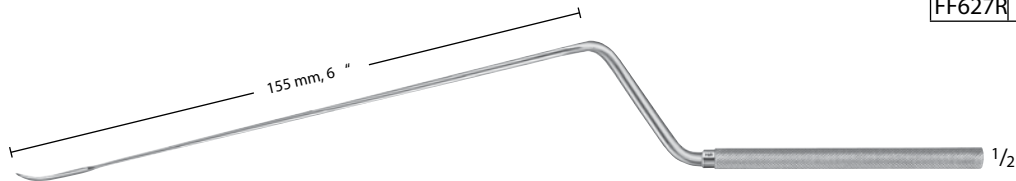

FF627R



FF627R

LANDOLT Spoon, Bayonet-Shaped

Catalog Number	Shaft	Working Length (in.)	Length (in.)
FF628R	MALLEABLE	6 1/8	10 1/4

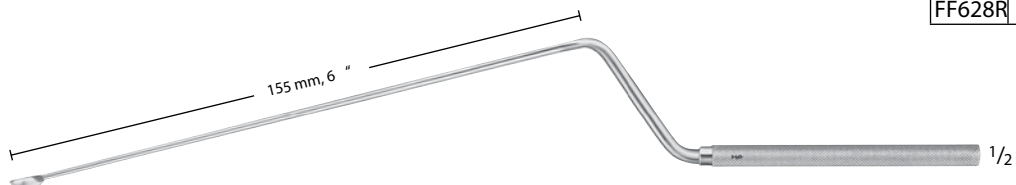

FF628R



FF628R

LANDOLT Hook, Blunt, Bayonet-Shaped

Catalog Number	Shaft	Working Length (in.)	Length (in.)
FF629R	MALLEABLE	6 1/8	10 1/4

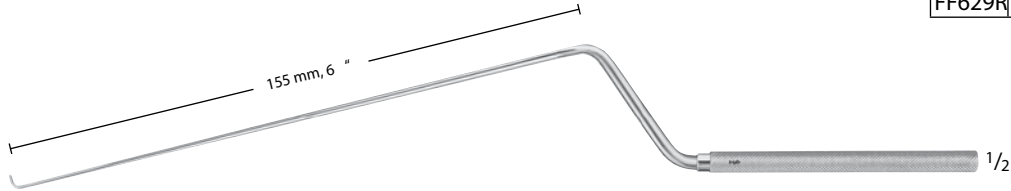

FF629R



FF629R

LANDOLT Enucleator, Malleable, Bayonet-Shaped

Catalog Number	Tip	Working Length (in.)	Length (in.)
FF625R	RIGHT BLUNT DOWN	6 1/8	10 1/4
FF626R	RIGHT BLUNT UP	6 1/8	10 1/4

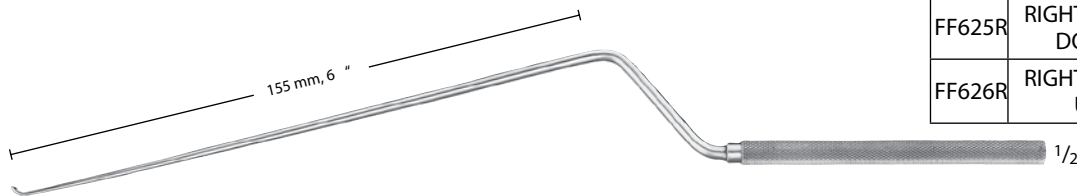

FF625R-FF626R



FF625R



FF626R

LANDOLT-REULEN Raspatory,
Bayonet-Shaped

Catalog Number	Diameter (mm)	Shaft	Working Length (in.)	Length (in.)
FF640R	2.2	RIGID	6 1/8	10 1/4
FF641R	3.2	RIGID	6 1/8	10 1/4



FF640R-FF641R

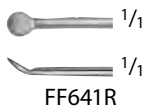
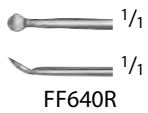

LANDOLT-REULEN Curette,
Bayonet-Shaped

Catalog Number	Diameter (mm)	Shaft	Working Length (in.)	Length (in.)
FF642R	2.5	RIGID	6 1/8	10 1/4

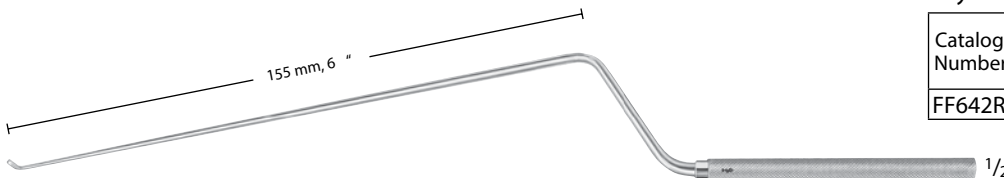

FF642R

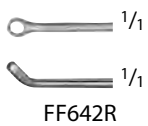

LANDOLT-REULEN Hook, Blunt,
Bayonet-Shaped

Catalog Number	Tip Size (mm)	Shaft	Working Length (in.)	Length (in.)
FF643R	1.7	RIGID	6 1/8	10 1/4

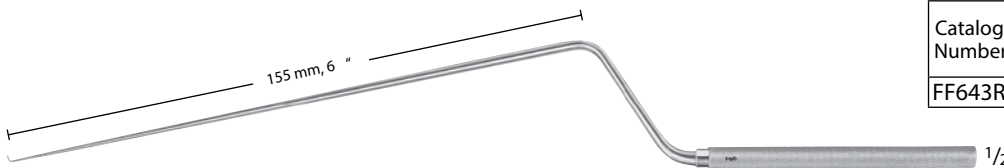

FF643R

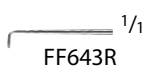

LANDOLT-REULEN Dissector,
Bayonet-Shaped

Catalog Number	Diameter (mm)	Shaft	Working Length (in.)	Length (in.)
FF644R	2.0	RIGID	6 1/8	10 1/4

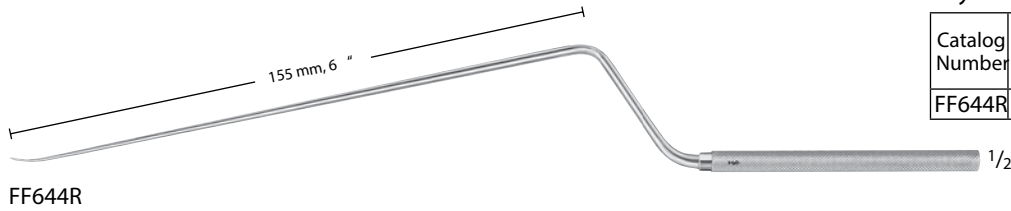

FF644R

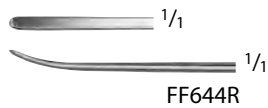

FF644R

FAHLBUSCH Spoon, Bayonet-Shaped

Catalog Number	Diameter (mm)	Shaft	Working Length (in.)	Length (in.)
FF635R	2.0	MALLEABLE	6 1/8	10 1/4

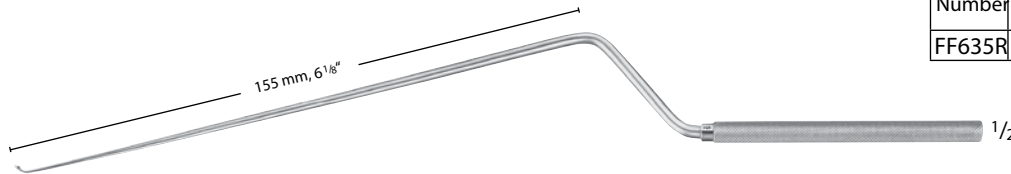

FF635R

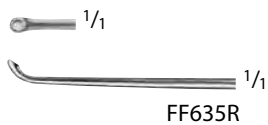

FF635R

FAHLBUSCH Curette, Bayonet-Shaped

Catalog Number	Diameter (mm)	Shaft	Working Length (in.)	Length (in.)
FF637R	2.5	MALLEABLE	6 1/8	10 1/4

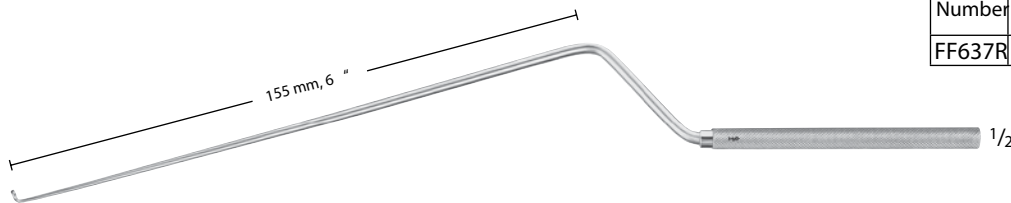

FF637R

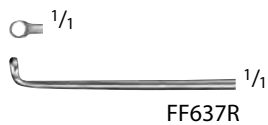

FF637R

D'ERRICO Hypophyseal Forceps

Catalog Number	Jaw	Jaw Size (mm)	Length (in.)
MF410R	CUP	6.0	8 1/2



MF410R



MF410R

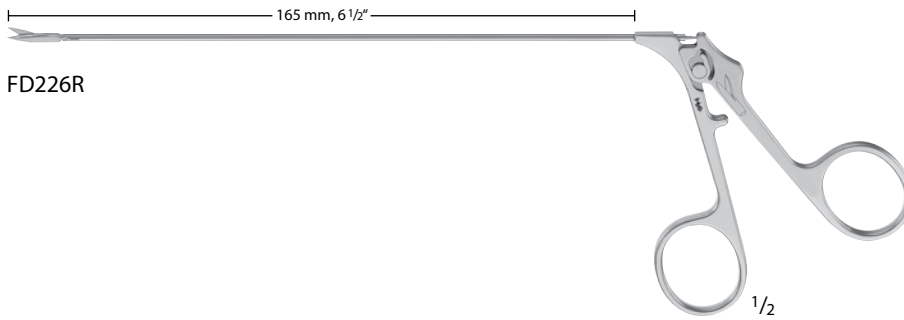

NICOLA Modular Micro Scissors

Catalog Number	Tip	Blade	Shaft	Working Length (in.)
FD226R	S/S	STR	TUBULAR	6 1/2

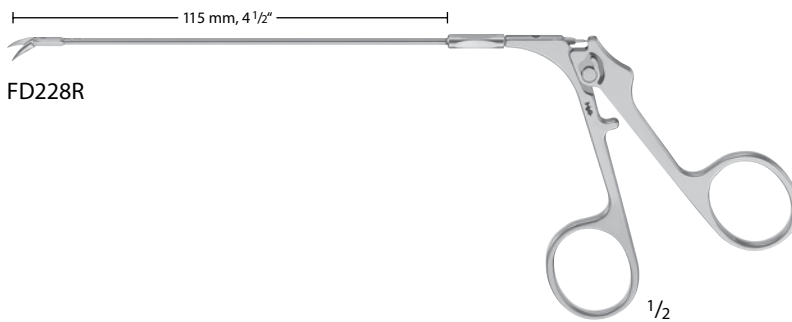
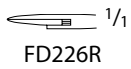

CASPAR Modular Micro Scissors

Catalog Number	Tip	Blade	Shaft	Working Length (in.)
FD228R	S/S	CVD	ROTATABLE 360°	4 1/2

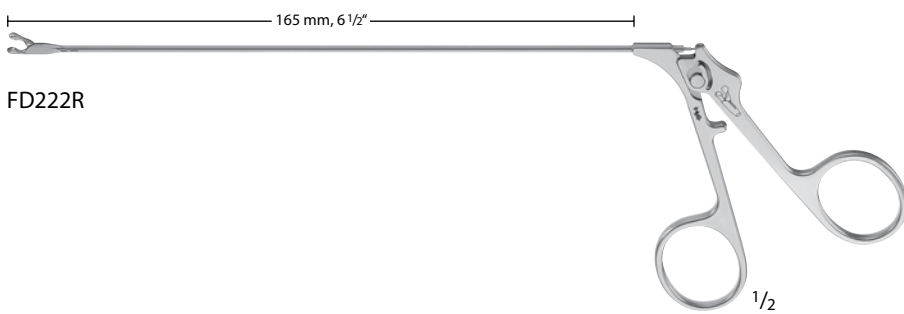
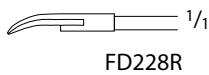

NICOLA Modular Micro Forceps

Catalog Number	Jaw	Tip Size (mm)	Working Length (in.)
FD222R	SCOOP-SHAPED	DIAM. 2.5 MM	6 1/2



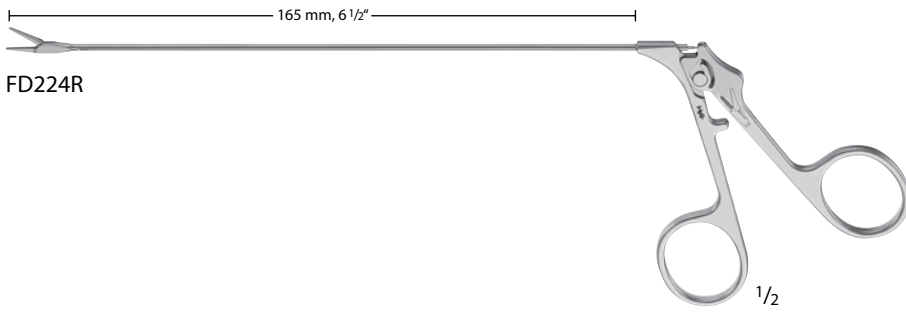

FD224R

YASARGIL-NICOLA Modular Micro Forceps

Catalog Number	Jaw	Tip	Working Length (in.)
FD224R	LONG	STR, SERR	6 1/2



FD224R

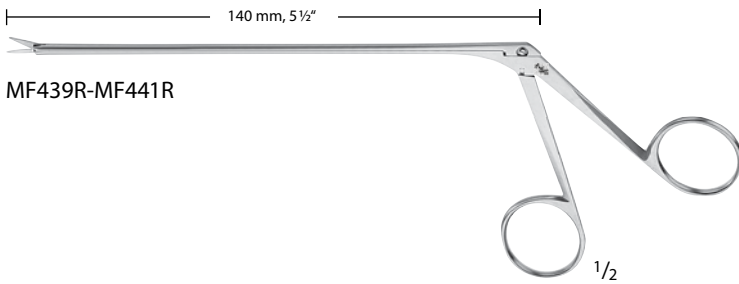

MF439R-MF441R

KURZE Dissecting Scissors

Catalog Number	Tip	Blade	Length (in.)
MF439R	B/B	STR	5 1/2
MF440R	B/B	CVD-LEFT	5 1/2
MF441R	B/B	CVD-RIGHT	5 1/2

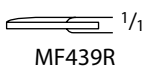

MF439R



MF440R



MF441R

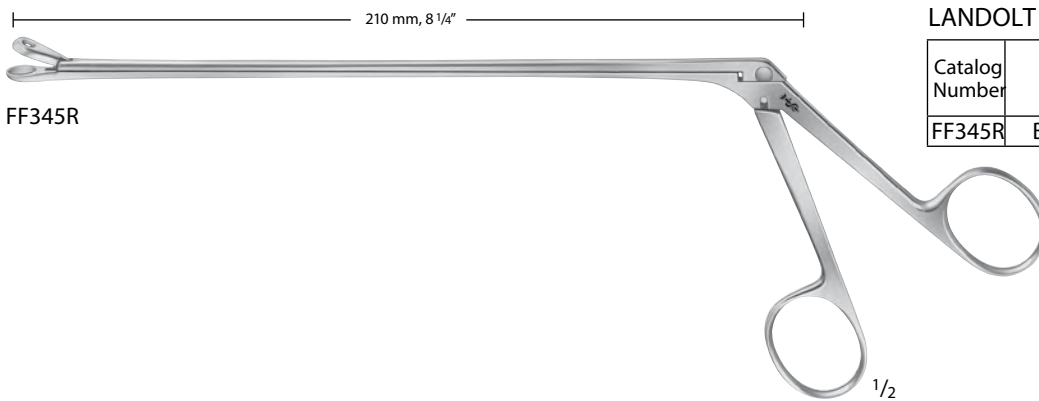

FF345R

LANDOLT Tumor Grasping Forceps

Catalog Number	Jaw	Jaw Size (mm)	Shaft Length (in.)
FF345R	BLUNT	DIAM. 9.0	8 1/4

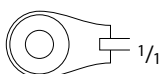

FF345R

- Teardrop shaped thumb control for a very precise suction regulation
- Malleable material for individual forming of the suction hose
- Conical design of the tube prevents plugging
- Delivered with stylet

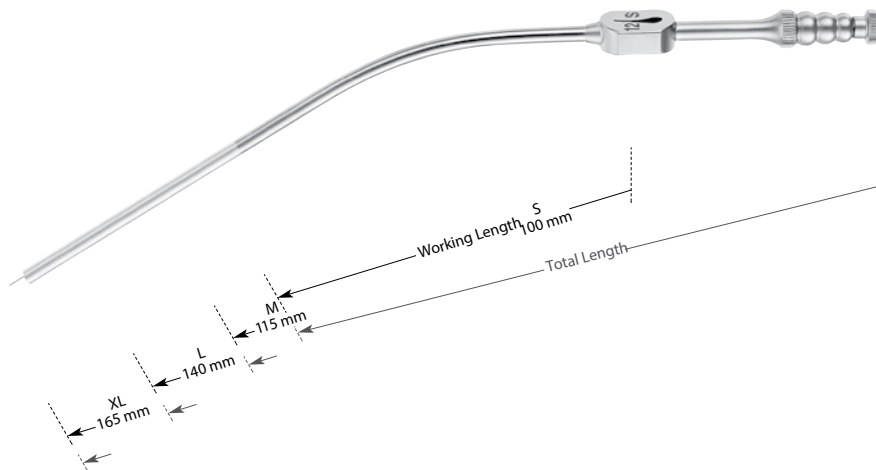

GF391R-GF429R

Suction Tube, Fukushima Style,
 W/ Tapered Teardrop Control

Catalog Number	Size	Tip Size (mm)	Tip Size (FR)	Working Length (in.)	Length (in.)
GF401R	S	1.0	3	4	6 1/2
GF402R	S	1.4	4	4	6 1/2
GF403R	S	1.7	5	4	6 1/2
GF404R	S	2.0	6	4	6 1/2
GF405R	S	2.3	7	4	6 1/2
GF406R	S	2.7	8	4	6 1/2
GF407R	S	3.0	9	4	6 1/2
GF408R	S	3.3	10	4	6 1/2
GF409R	S	4.0	12	4	6 1/2
GF391R	M	1.0	3	4 1/2	7
GF392R	M	1.4	4	4 1/2	7
GF393R	M	1.7	5	4 1/2	7
GF394R	M	2.0	6	4 1/2	7
GF395R	M	2.3	7	4 1/2	7
GF396R	M	2.7	8	4 1/2	7
GF397R	M	3.0	9	4 1/2	7
GF398R	M	3.3	10	4 1/2	7
GF399R	M	4.0	12	4 1/2	7
GF411R	L	1.0	3	5 1/2	8
GF412R	L	1.4	4	5 1/2	8
GF413R	L	1.7	5	5 1/2	8
GF414R	L	2.0	6	5 1/2	8
GF415R	L	2.3	7	5 1/2	8
GF416R	L	2.7	8	5 1/2	8
GF417R	L	3.0	9	5 1/2	8
GF418R	L	3.3	10	5 1/2	8
GF419R	L	4.0	12	5 1/2	8
GF421R	XL	1.0	3	6 1/2	9
GF422R	XL	1.4	4	6 1/2	9
GF423R	XL	1.7	5	6 1/2	9
GF424R	XL	2.0	6	6 1/2	9
GF425R	XL	2.3	7	6 1/2	9
GF426R	XL	2.7	8	6 1/2	9
GF427R	XL	3.0	9	6 1/2	9
GF428R	XL	3.3	12	6 1/2	9
GF429R	XL	4.0	12	6 1/2	9

Let Us know if you could not find what you are looking for



GF025B-GF059B



MIN Instruments, Noir™ Modular Suction Cannula,
 F/ Golfball Handle

Catalog Number	Size	Tip	Tip Size (mm)	Tip Size (FR)	Working Length (in.)
GF025B	S	STR	1.4	4	3 1/8
GF026B	S	STR	2.0	6	3 1/8
GF027B	S	STR	2.7	8	3 1/8
GF030B	M	CVD LEFT	2.0	6	4
GF031B	M	CVD RIGHT	2.0	6	4
GF032B	M	CVD LEFT	2.7	8	4
GF033B	M	CVD RIGHT	2.7	8	4
GF035B	M	STR	1.4	4	4
GF036B	M	STR	2.0	6	4
GF037B	M	STR	2.7	8	4
GF038B	M	STR, LATERAL HOLES	2.0	6	4
GF039B	M	STR, LATERAL HOLES	2.7	8	4
GF045B	L	STR	1.4	4	4 3/4
GF046B	L	STR	2.0	6	4 3/4
GF047B	L	STR	2.7	8	4 3/4
GF048B	L	STR, LATERAL HOLES	2.0	6	4 3/4
GF049B	L	STR, LATERAL HOLES	2.7	8	4 3/4
GF055B	XL	STR	1.4	4	5 1/2
GF056B	XL	STR	2.0	6	5 1/2
GF057B	XL	STR	2.7	8	5 1/2
GF058B	XL	STR, LATERAL HOLES	2.0	6	5 1/2
GF059B	XL	STR, LATERAL HOLES	2.7	8	5 1/2



GF005B

Modular Thumb Control for MIN
 Suction Cannulas

Catalog Number	Description
GF005B	TEAR DROP SHAPED



GF240R-GF278R

Modular Suction Cannula

Catalog Number	Size)	Tip Size (mm)	Tip Size (FR)	Working Length (in.)	Length (in.)
GF240R	S	1.0	3	4	7 1/4
GF241R	S	1.4	4	4	7 1/4
GF242R	S	1.7	5	4	7 1/4
GF243R	S	2.0	6	4	7 1/4
GF244R	S	2.3	7	4	7 1/4
GF245R	S	2.7	8	4	7 1/4
GF246R	S	2.0	9	4	7 1/4
GF247R	S	3.3	10	4	7 1/4
GF248R	S	4.0	12	4	7 1/4
GF250R	M	1.0	3	4 1/2	7 7/8
GF251R	M	1.4	4	4 1/2	7 7/8
GF252R	M	1.7	5	4 1/2	7 7/8
GF253R	M	2.0	6	4 1/2	7 7/8
GF254R	M	2.3	7	4 1/2	7 7/8
GF255R	M	2.7	8	4 1/2	7 7/8
GF256R	M	3.0	9	4 1/2	7 7/8
GF257R	M	3.3	10	4 1/2	7 7/8
GF258R	M	4.0	12	4 1/2	7 7/8
GF260R	L	1.0	3	5 1/2	8 7/8
GF261R	L	1.4	4	5 1/2	8 7/8
GF262R	L	1.7	5	5 1/2	8 7/8
GF263R	L	2.0	6	5 1/2	8 7/8
GF264R	L	2.3	7	5 1/2	8 7/8
GF265R	L	2.7	8	5 1/2	8 7/8
GF266R	L	3.0	9	5 1/2	8 7/8
GF267R	L	3.3	10	5 1/2	8 7/8
GF268R	L	4.0	12	5 1/2	8 7/8
GF270R	XL	1.0	3	6 1/2	9 3/4
GF271R	XL	1.4	4	6 1/2	9 3/4
GF272R	XL	1.7	5	6 1/2	9 3/4
GF273R	XL	2.0	6	6 1/2	9 3/4
GF274R	XL	2.3	7	6 1/2	9 3/4
GF275R	XL	2.7	8	6 1/2	9 3/4
GF276R	XL	3.0	9	6 1/2	9 3/4
GF277R	XL	3.3	10	6 1/2	9 3/4
GF278R	XL	4.0	12	6 1/2	9 3/4



GF235R

Thumb Control for Modular Suction Tubes

Catalog Number	Shape
GF235R	TEARDROP SHAPED

Let Us know if you could not find what you are looking for

RAABE Micro Suction Tube, W/ Tapered Teardrop Control

Catalog Number	Tip	Tip Size (mm)	Tip Size (FR)	Handle	Working Length (in.)	Length (in.)
GF470R	ATRAUMATIC	1.4	4	YELLOW	3 1/8	5 1/8
GF471R	ATRAUMATIC	2.0	6	BLUE	3 1/8	5 1/8
GF472R	ATRAUMATIC	2.7	8	GREEN	3 1/8	5 1/8
GF473R	ATRAUMATIC	1.4	4	YELLOW	4	6
GF474R	ATRAUMATIC	2.0	6	BLUE	4	6
GF475R	ATRAUMATIC	2.7	8	GREEN	4	6
GF476R	ATRAUMATIC	1.4	4	YELLOW	4 3/4	6 1/2
GF477R	ATRAUMATIC	2.0	6	BLUE	4 3/4	6 1/2
GF478R	ATRAUMATIC	2.7	8	GREEN	4 3/4	6 1/2
GF479R	ATRAUMATIC	1.4	4	YELLOW	5 1/2	7 1/4
GF480R	ATRAUMATIC	2.0	6	BLUE	5 1/2	7 1/4
GF481R	ATRAUMATIC	2.7	8	GREEN	5 1/2	7 1/4



GF470R-GF481R

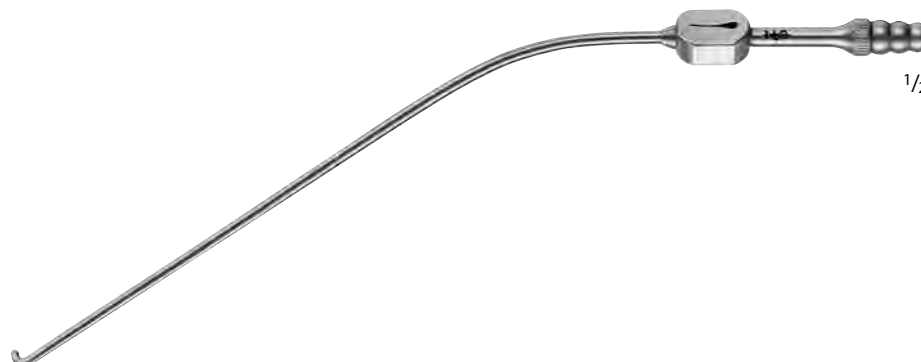

GF431R-GF432R



GF431R-GF432R

Suction Tube, Fukushima Style,
 W/ Tapered Teardrop Control

Catalog Number	Tip	Tip Size (mm)	Tip Size (FR)	Working Length (in.)	Length (in.)
GF431R	CVD-RIGHT	2.0	8	5 1/4	9 3/4
GF432R	CVD-LEFT	2.0	6	5 1/4	9 3/4

Let Us know if you could not find what you are looking for

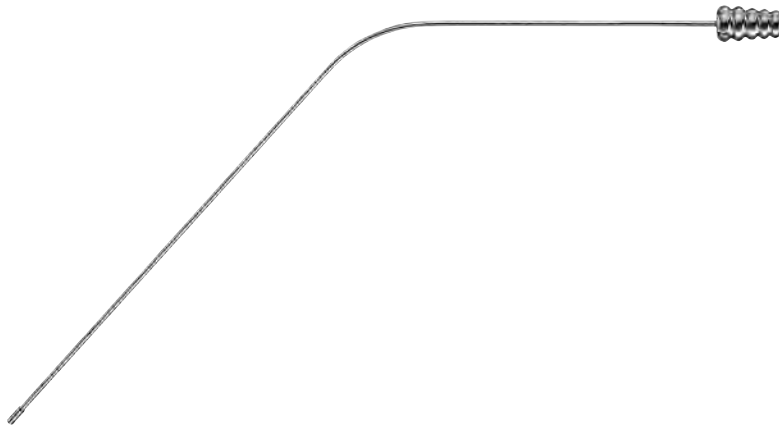

MD540R-MD556R

YASARGIL Suction Tube

Catalog Number	Tip Size (mm)	Length (in.)
MD540R	1.5	5
MD541R	1.5	6
MD542R	1.5	7
MD543R	1.5	8 1/2
MD544R	2.0	5
MD545R	2.0	6
MD546R	2.0	7
MD547R	2.0	8 1/2
MD548R	2.5	5
MD549R	2.5	6
MD550R	2.5	7
MD551R	2.5	8 1/2
MD552R	3.5	5
MD553R	3.5	6
MD554R	3.5	7
MD555R	3.5	8 1/2
MD556R	4.5	7

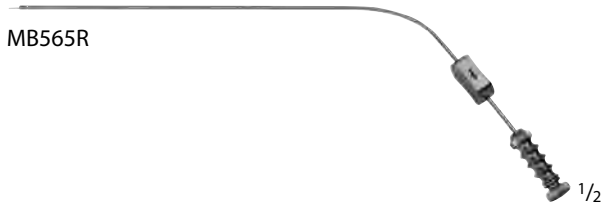

MB565R

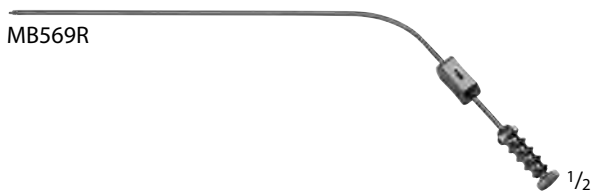

MB569R



MB583R



MB554R

MCCULLOCH Suction Tube

Catalog Number	Tip Size (mm)	Length (in.)
MB708R	COMPLETE SET	5 3/4
MB565R	1.7	5 3/4
MB569R	2.3	5 3/4
MB583R	3.0	5 3/4
MB554R	4.0	5 3/4

MB708R Set of 4 Includes:
 1 Suction cannula of each MB554R, MB565R,
 MB569R, MB583R

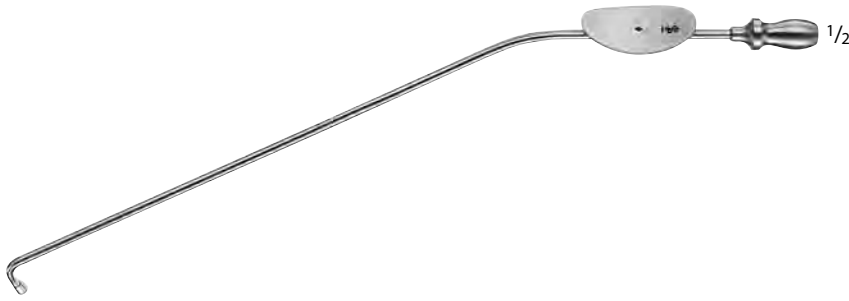

MF106R-MF111R

Atraumatic Suction Tube

Catalog Number	Tip	Tip Size (FR)	Length (in.)
MF106R	90° DOWN	5	8 1/2
MF107R	90° DOWN	7	8 1/2
MF108R	90° DOWN	10	8 1/2
MF109R	90° UP	5	8 1/2
MF110R	90° UP	7	8 1/2
MF111R	90° UP	10	8 1/2

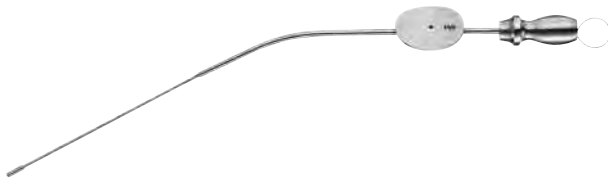

MF333R-MF347R

Atraumatic Suction Tube

Catalog Number	Tip Size (FR)	Working Length (in.)	Length (in.)
MF333R	3	3	6 1/4
MF334R	5	3	6 1/4
MF335R	7	3	6 1/4
MF336R	10	3	6 1/4
MF337R	12	3	6 1/4
MF338R	3	4	7 1/4
MF339R	5	4	7 1/4
MF340R	7	4	7 1/4
MF341R	10	4	7 1/4
MF342R	12	4	7 1/4
MF343R	3	5	8 1/4
MF344R	5	5	8 1/4
MF345R	7	5	8 1/4
MF346R	10	5	8 1/4
MF347R	12	5	8 1/4



MF133R-MF135R

FRAZIER Suction Dissector

Catalog Number	Tip Size (FR)	Working Length (in.)
MF133R	5	6 1/2
MF134R	7	6 1/2
MF135R	10	6 1/2



MF479R-MF508R

FRAZIER Slotted Suction Tube, Straight

Catalog Number	Tip Size (FR)	Length (in.)
MF479R	3	5 1/2
MF480R	4	5 1/2
MF481R	5	5 1/2
MF482R	6	5 1/2
MF483R	7	5 1/2
MF484R	8	5 1/2
MF485R	9	5 1/2
MF486R	10	5 1/2
MF487R	11	5 1/2
MF488R	12	5 1/2
MF499R	3	7
MF500R	4	7
MF501R	5	7
MF502R	6	7
MF503R	7	7
MF504R	8	7
MF505R	9	7
MF506R	10	7
MF507R	11	7
MF508R	12	7

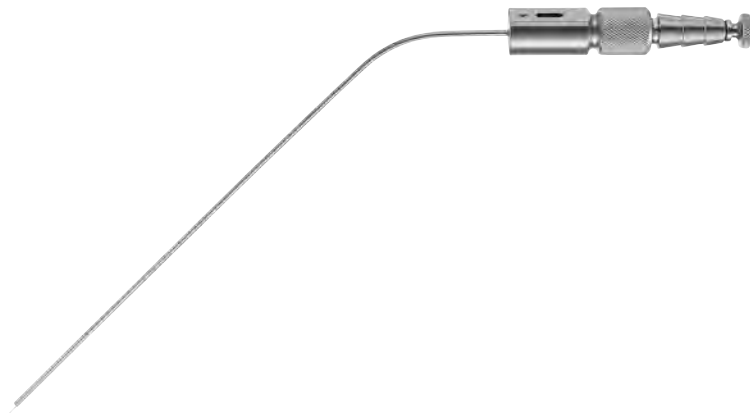

MF489R-MF518R

FRAZIER Slotted Suction Tube, Angled

Catalog Number	Tip Size (FR)	Length (in.)
MF489R	3	5 1/2
MF490R	4	5 1/2
MF491R	5	5 1/2
MF492R	6	5 1/2
MF493R	7	5 1/2
MF494R	8	5 1/2
MF495R	9	5 1/2
MF496R	10	5 1/2
MF497R	11	5 1/2
MF498R	12	5 1/2
MF509R	3	7
MF510R	4	7
MF511R	5	7
MF512R	6	7
MF513R	7	7
MF514R	8	7
MF515R	9	7
MF516R	10	7
MF517R	11	7
MF518R	12	7

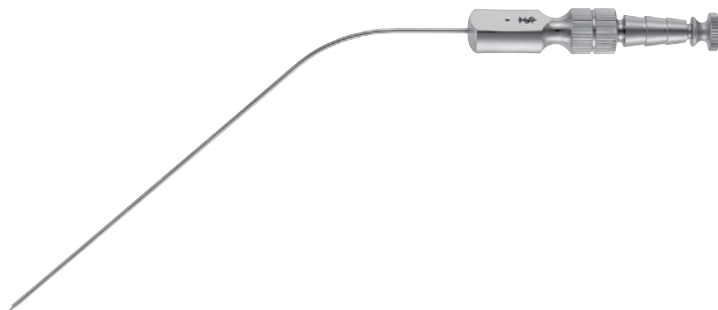

GF350R-GF385R

FERGUSSON Suction Tube, Luer Hub

Catalog Number	Diameter (mm)	Working Length (in.)	Length (in.)
GF350R	1.5	4 1/4	7 3/4
GF351R	2.0	4 1/4	7 3/4
GF352R	2.5	4 1/4	7 3/4
GF353R	3.0	4 1/4	7 3/4
GF354R	4.0	4 1/4	7 3/4
GF355R	5.0	4 1/4	7 3/4
GF360R	1.5	5 1/8	8 1/2
GF361R	2.0	5 1/8	8 1/2
GF362R	2.5	5 1/8	8 1/2
GF363R	3.0	5 1/8	8 1/2
GF364R	4.0	5 1/8	8 1/2
GF365R	5.0	5 1/8	8 1/2
GF370R	1.5	6 1/4	9 5/8
GF371R	2.0	6 1/4	9 5/8
GF372R	2.5	6 1/4	9 5/8
GF373R	3.0	6 1/4	9 5/8
GF374R	4.0	6 1/4	9 5/8
GF375R	5.0	6 1/4	9 5/8
GF380R	1.5	7 7/8	11
GF381R	2.0	7 7/8	11
GF382R	2.5	7 7/8	11
GF383R	3.0	7 7/8	11
GF384R	4.0	7 7/8	11
GF385R	5.0	7 7/8	11



ADSON Suction Tube

Catalog Number	Tip Size (mm)	Tip Size (FR)	Length (in.)
GF917R	4	11	7 1/2



SACHS Suction Tube

Catalog Number	Tip Size (mm)	Length (in.)
MB635R	SMALL	8 1/2
MB636R	LARGE	8 1/2

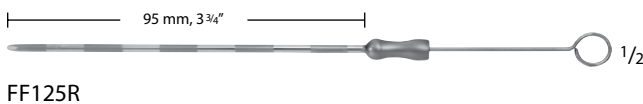

CUSHING-CAIRNS Ventricular Cannula

Catalog Number	Diameter (mm)	Working Length (in.)
FF125R	2.3	3 3/4
FF126R	2.6	3 3/4



FK328R

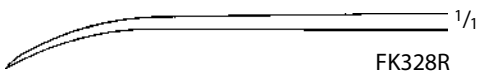
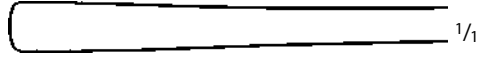

FK328R



FK329R

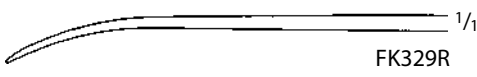
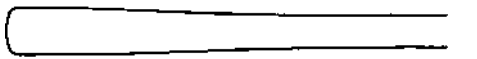

FK329R



MF405R-MF406R

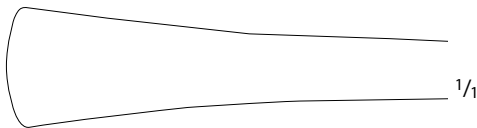

MF405R

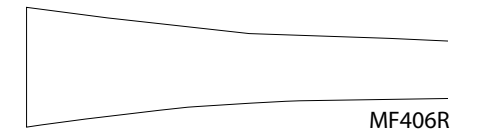

MF406R



MF326R-MF328R

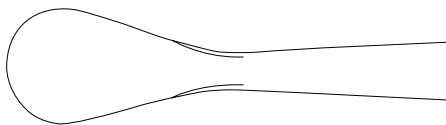

MF328R

CASPAR Muscle Dissector

Catalog Number	Tip	Width (mm)	Length (in.)
FK328R	SHARP	6.2	7
FK329R	BLUNT	6.2	7

CUSHING Periosteal Elevator

Catalog Number	Tip	Width (mm)	Length (in.)
MF405R	ROUND, SHARP	15	7 1/4
MF406R	SQUARE, SHARP	15	7 1/4

HOEN Periosteal Elevator

Catalog Number	Tip Size (mm)	Length (in.)
MF326R	7.0	7 1/4
MF327R	15.0	7 1/4
MF328R	20.0	7 1/4

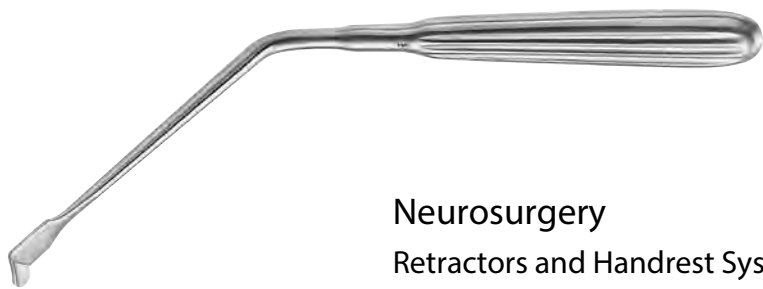

Neurosurgery
 Retractors and Handrest Systems

MF139R-MF141R

SCOVILLE Nerve Root Retractor

Catalog Number	Shape	Width (mm)	Working Length (in.)
MF139R	45°	8.0	4
MF140R	90°	8.0	4
MF141R	STR	8.0	7 1/4



FF707R-FF709R

HESS Nerve Root Retractor

Catalog Number	Width (mm)	Working Length (in.)	Length (in.)
FF707R	3.0	3 1/2	6 7/8
FF708R	5.0	3 1/2	6 7/8
FF709R	7.0	3 1/2	6 7/8

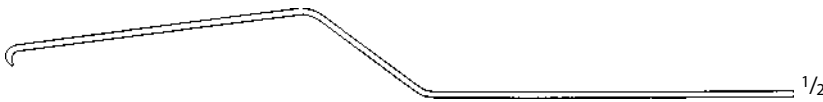

LOVE Nerve Root Retractor

Catalog Number	Length (in.)
FF700R	8 1/4

LOVE Nerve Root Retractor

Catalog Number	Shape	Length (in.)
FF701R	STR	8 3/4
FF702R	45°	8 3/4
FF703R	90°	8 3/4

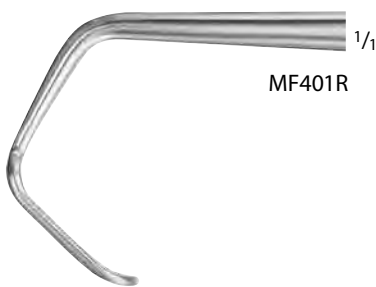

CUSHING Decompression Retractor

Catalog Number	Tip	Length (in.)
MF401R	ANG	8 1/4



SACHS Vein Retractor

Catalog Number	Tip	Blade	Length (in.)
MF402R	ANG	TOOTHED	8 1/2
MF403R	ANG	PLAIN	8 1/2
MF404R	ANG, SHARP	HOOK	8 1/2



MF057R

D'ERRICO Nerve Root Retractor,
 Bayonet-Shaped

Catalog Number	Length (in.)
MF057R	9

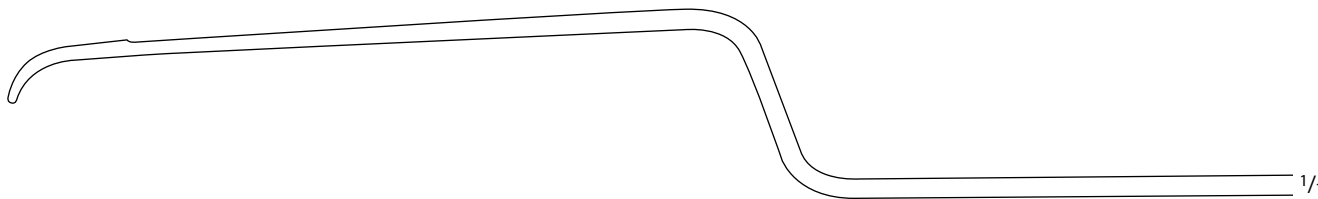

MF057R



FF697R-FF710R

CASPAR Nerve Root Retractor

Catalog Number	Width (mm)	Length (in.)
FF697R	4.0	9 1/2
FF699R	6.0	9 1/2
FF710R	8.0	9 1/2
FF698R	10.0	9 1/2

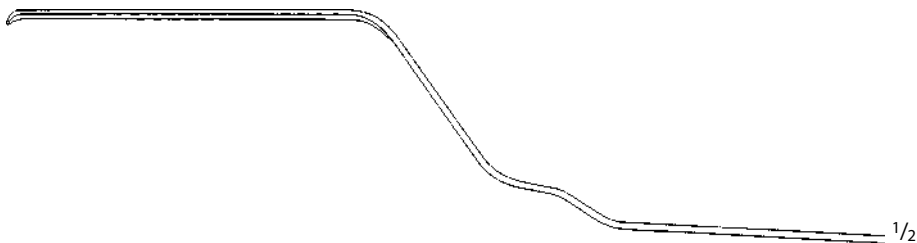

FF697R-FF710R

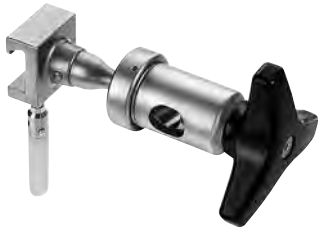

FF280R-FF286R

Ball and Socket Joint, F/ Holding Rod
FF285R

Catalog Number	Size (mm)
FF280R	10 x 25
FF286R	9 x 32



FF285R

Holding Rod, F/ Ball and Socket Joint
FF280R

Catalog Number	Compatible w/
FF285R	FF282R, FF283R or FF284R



FF282R

Coupling Head, F/ Up to 5 Flexible
Arms FF270R

Catalog Number
FF282R



FF283R

Coupling Head, F/ Flexible Arm FF270R,
Rotatable

Catalog Number
FF283R



FF284R

Coupling Head, F/ Flexible Arm FF270R,
 Rotatable, Laterally Open

Catalog Number
FF284R



FF270R

YASARGIL Flexible Arm

Catalog Number	Description
FF270R	COUPLING HEADS: FF282R, FF283R, FF284R FIXATION BASES: FF266R, FF267R, FF268R



FF273R

Support for Brain Spatula, F/ Flexible
 Arm FF270R

Catalog Number
FF273R



FF274R

Support for Brain Spatula, W/ Round
 Shaft, F/ Flexible Arm FF270R

Catalog Number
FF274R



FF260R

YASARGIL Self-Retaining Retractor,
W/ 1 Flexible Arm

Catalog Number
FF260R

FF260R Includes:
1 Fixation base FF266R,
1 Flexible arm FF270R and
1 Support for brain spatula FF273R

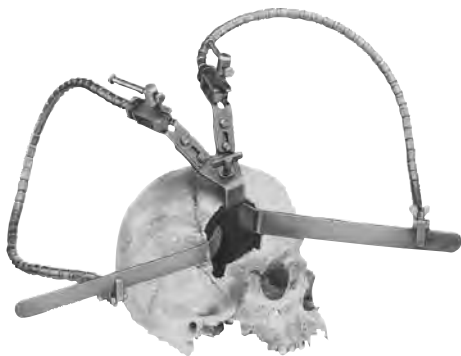

FF262R

YASARGIL Self-Retaining Retractor,
W/ 2 Flexible Arms

Catalog Number
FF262R

FF262R Includes:
1 Fixation base FF268R,
2 Flexible arms FF270R and
2 Supports for brain spatulas FF273R



FF266R

Fixation Base, F/ Skull Mounting, Holds
1 Flexible Arm FF260R

Catalog Number
FF266R



FF268R

Fixation Base, F/ Skull Mounting, Hold
2 Flexible Arms FF270R

Catalog Number
FF268R

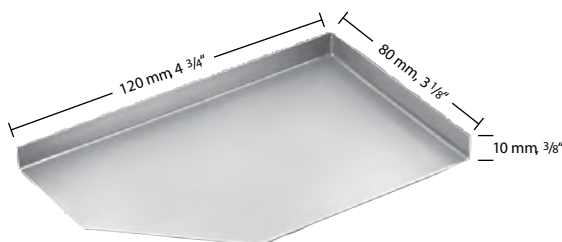

FF180R

Utility Tray

Catalog Number	Compatible w/	Width (in.)	Length (in.)
FF180R	FLEXIBLE ARMS FF270R AND FF273R	3 1/8	4 3/4

NEW JERSEY Flexible Arm

Catalog Number
FF431R

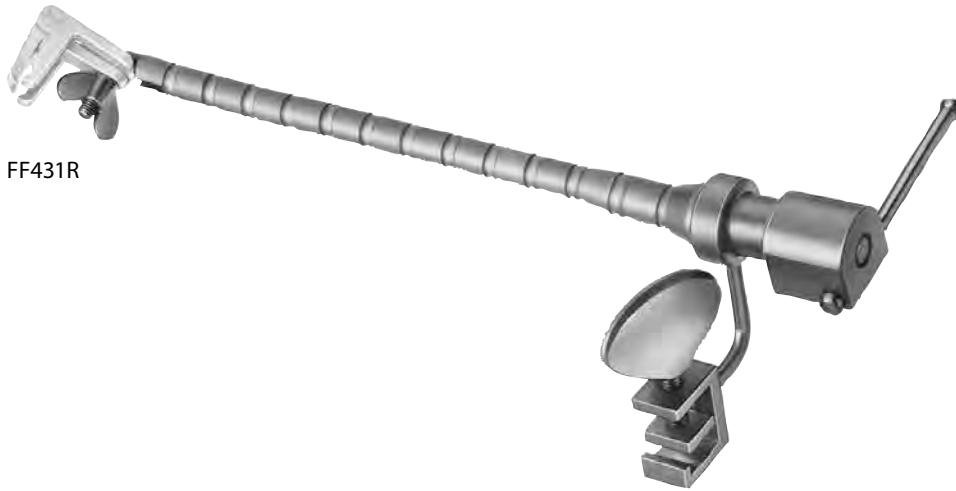

FF431R



FF151R

Table Attachment

Catalog Number	Compatible w/
FF151R	FF150R



FF154R

FF153R

FF150R

FF152R

GILSBACH Basic Unit

Catalog Number	Description
FF150R	COMPLETE BASIC UNIT
FF152R	GILSBACH INSULATING HOLDING ROD
FF153R	GILSBACH SEMI-CIRCULAR BASIC BAR
FF154R	FRAME FOR GALEA HOOK

FF150R Includes:

- 1 Insulated holding rod FF152R
- 1 Semi-circular basic bar FF153R
- 1 Frame FF154R for Galea hook

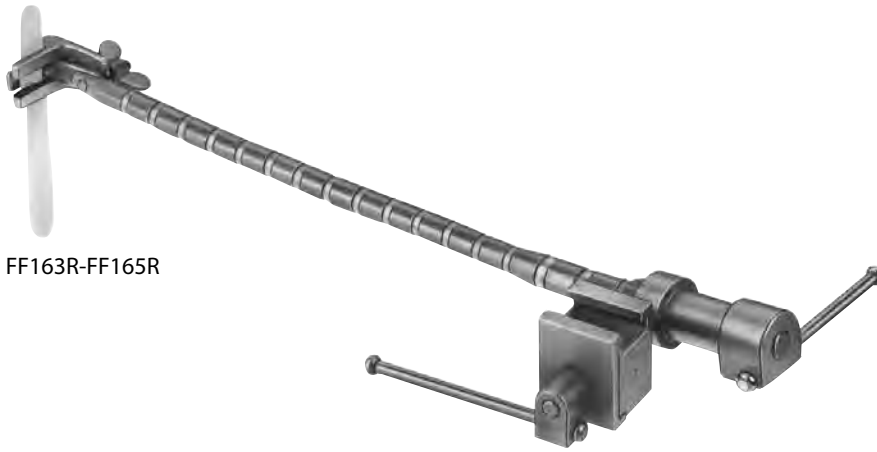

FF163R-FF165R

GILSBACH Flexible Arm

Catalog Number	Length (in.)
FF163R	7 7/8
FF165R	9 3/4



FF185R

Forceps Holder

Catalog Number	Compatible w/
FF185R	FF153R

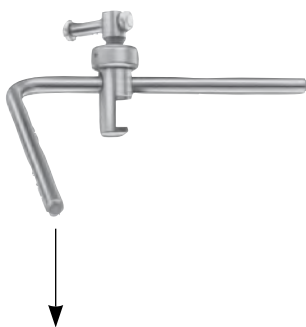

FF187R

GILSBACH Handrest, Adjustable Height

Catalog Number	Compatible w/
FF187R	FF153R



GILSBACH Holding Rod, F/ MAYFIELD Head Holder

Catalog Number	Description
FF190R	COMPLETE HOLDING DEVICE
FF191R	HOLDING ROD TO BE FIXED TO MAYFIELD HEAD HOLDER
FF193R	CONNECTION PIECE TO BE MOUNTED TO HOLDING ROD FF191R

FF191R Connection Piece is compatible with FF152R, FF191R and FF285R holding rods

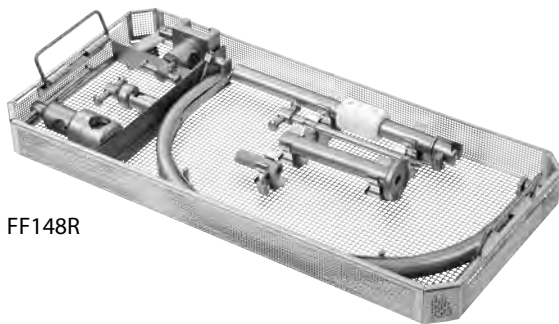

FF148R

Storage Basket for GILSBACH Basic Unit

Catalog Number	Dimensions (mm)
FF148R	540 x 253 x 56

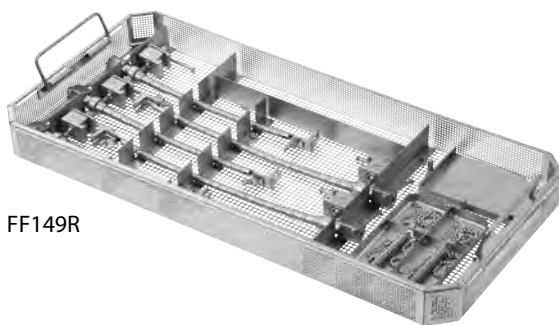

FF149R

Storage Basket for GILSBACH Flexible Arms

Catalog Number	Dimensions (mm)
FF149R	540 x 254 x 50



FF480R-FF488R

Silicone Brain Spatula, Flat, Single Use

Catalog Number	Blade Size (mm)	Packaging	Length (in.)
FF480R	6.0	BOX OF 10	7 7/8
FF482R	7.5	BOX OF 10	7 7/8
FF484R	10.0	BOX OF 10	7 7/8
FF486R	12.5	BOX OF 10	7 7/8
FF488R	15.0	BOX OF 10	7 7/8

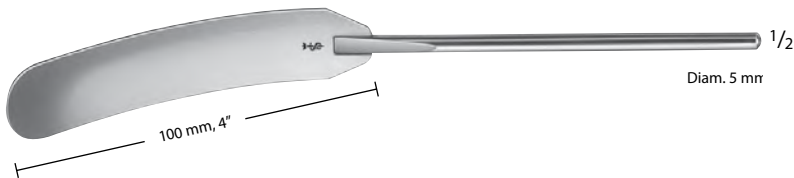

FF231R-FF233R

Malleable Brain Spatula W/ Round Shaft for FF274R

Catalog Number	Working Length (in.)	Blade Size (mm)	Diameter (mm)	Length (in.)
FF231R	4	14	5.0	7 7/8
FF232R	4	17	5.0	7 7/8
FF233R	4	20	5.0	7 7/8



FF256R-FF259R

HEIFETZ Malleable Brain Spatula W/ Round Shaft for FF274R

Catalog Number	Working Length (in.)	Blade Size (mm)	Diameter (mm)	Length (in.)
FF256R	4	8	3.5	6 1/8
FF257R	4	11	3.5	6 1/8
FF258R	4	14	3.5	6 1/8
FF259R	4	17	3.5	6 1/8



FF441R-FF446R

AACHEN (MARTIN) Brain Spatula,
 Malleable

Catalog Number	Blade Size (mm)	Length (in.)
FF441R	7 x 8	7 7/8
FF442R	10 x 11	7 7/8
FF443R	13 x 14	7 7/8
FF444R	16 x 17	7 7/8
FF445R	19 x 20	7 7/8
FF446R	22 x 25	7 7/8



FF201R-FF222R

Brain Spatula, Flat, Malleable

Catalog Number	Blade Size (mm)	Length (in.)
FF201R	9	7 7/8
FF202R	12	7 7/8
FF222R	12	9 3/4



FF211R-FF214R

Brain Spatula, Flat, Malleable

Catalog Number	Blade Size (mm)	Length (in.)
FF211R	7 x 9	7
FF212R	11 x 13	7
FF213R	15 x 18	7
FF214R	18 x 22	7



FF216R-FF217R

OLIVECRONA Brain Spatula, Flat,
 Malleable

Catalog Number	Blade Size (mm)	Length (in.)
FF216R	7 x 9	7
FF217R	11 x 13	7



MD111-MD116

DAVIS Brain Spatula, Flat, Malleable

Catalog Number	Blade Size (mm)
MD111	6.0
MD112	9.0
MD113	13.0
MD114	16.0
MD115	19.0
MD116	25.0



MF348R-MF355R

Silicone Coated Brain Spatula, Post

Catalog Number	Blade Size (mm)	Length (in.)
MF348R	6.0	5 3/4
MF350R	8.0	5 3/4
MF349R	10.0	5 3/4
MF352R	11.0	5 3/4
MF354R	14.0	5 3/4
MF351R	15.0	5 3/4
MF353R	20.0	5 3/4
MF355R	25.0	5 3/4



MF356R-MF359R

Silicone Coated Brain Spatula

Catalog Number	Blade Size (mm)	Length (in.)
MF356R	10 x 6	6 3/4
MF357R	15 x 8	6 3/4
MF358R	20 x 11	6 3/4
MF359R	25 x 14	6 3/4

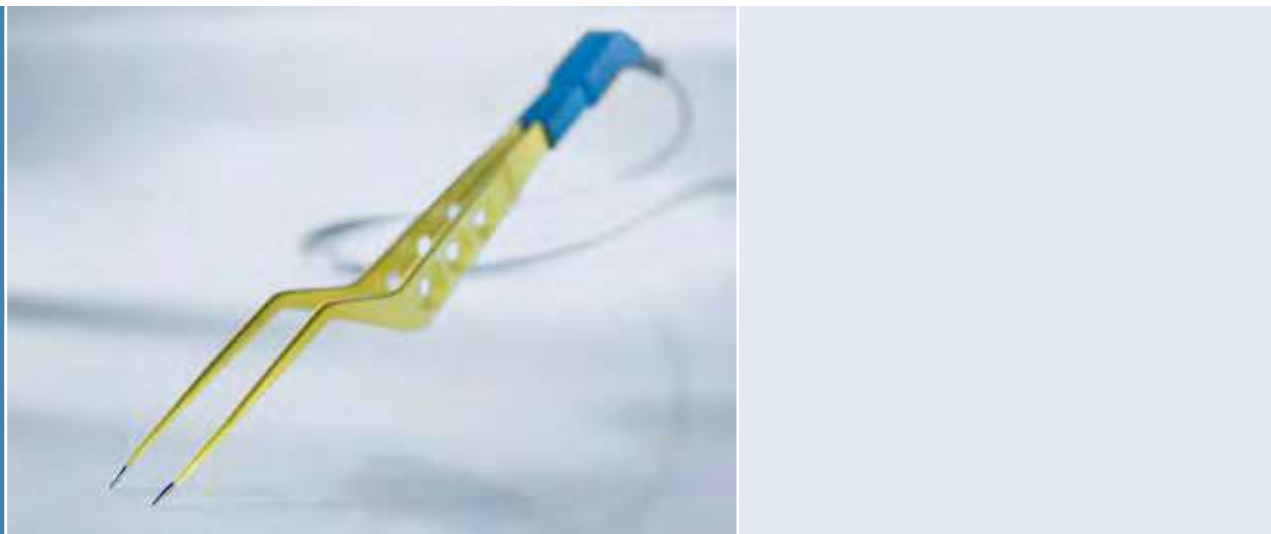

Electrosurgery

BipoJET Bipolar Scissors	1168
Non-Irrigating Bipolar Forceps	1169 - 1190
Irrigating Bipolar Forceps	1191 - 1194
Disposable Bipolar Forceps	1195 - 1197
Bipolar Connecting Cords	1198 - 1200

The versatility of BipoJET Dissecting Bipolar Scissors enables:

■ Parallel Cutting and Coagulating

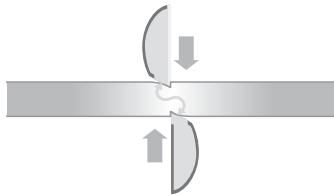

■ Precoagulation

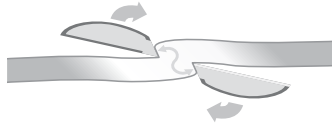

■ Pinpoint Coagulation



■ Surface Coagulation



BC691R-BC693R



BC691R-BC693R 1/1



BC694R-BC696R



BC694R-BC696R 1/1



BC685R-BC690R



BC685R 1/1



BC686R 1/1

METZENBAUM Bipolar Dissecting Scissors

Catalog Number	Tip	Length (in.)
BC691R	X-FINE	4 3/4
BC692R	X-FINE	5 1/2
BC693R	X-FINE	6 1/4

STEVENS Bipolar Dissecting Scissors

Catalog Number	Tip	Length (in.)
BC694R	TENOTOMY	4 3/4
BC695R	TENOTOMY	5 1/2
BC696R	TENOTOMY	6 1/4

METZENBAUM Bipolar Dissecting Scissors

Catalog Number	Tip	Length (in.)
BC685R	STANDARD	7
BC687R	STANDARD	9
BC689R	STANDARD	11
BC686R	FINE	7
BC688R	FINE	9
BC690R	FINE	11

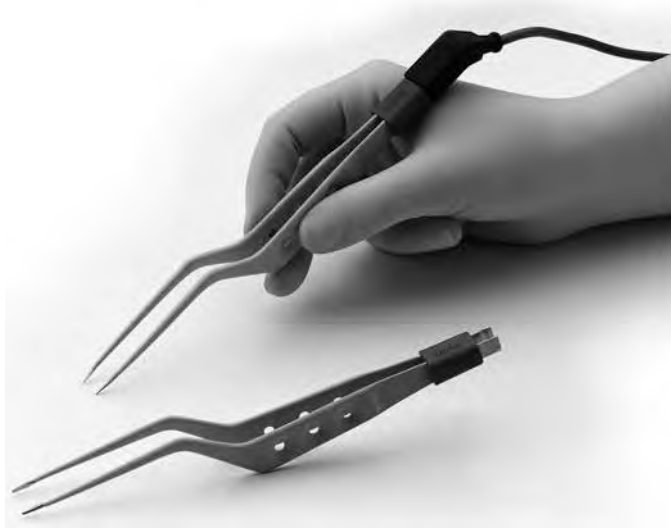

YASARGIL Bipolar Forceps Features:

- High precision, tissue preserving preparation instrument
- Stronger tension of the forceps allows for blunt spreading of the tissue.

Tip Size Reference Chart

0.2 mm		0.8 mm	
0.25 mm		0.9 mm	
0.4 mm		1.0 mm	
0.5 mm		1.3 mm	
0.6 mm		1.5 mm	
0.7 mm		2.0 mm	

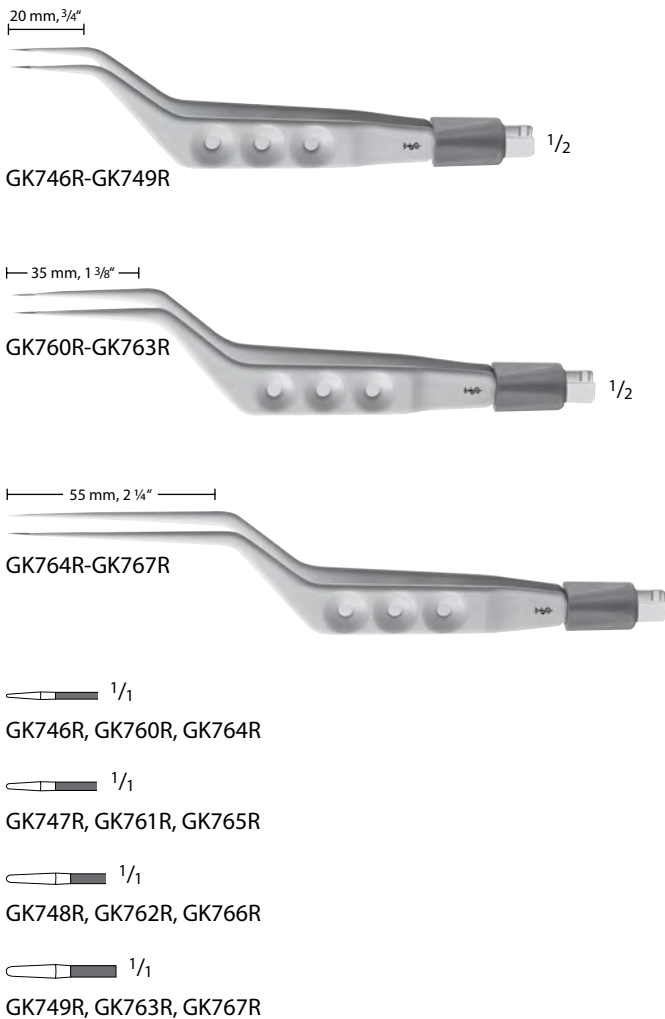

YASARGIL Style Bipolar Forceps, Stainless Steel

Catalog Number	Tip Size (mm)	Shape	Insulation	Irrigation	Working Length (in.)	Length (in.)
GK746R	0.4	BAYONET	INS*	NON-IRRG*	3/4	5 1/2
GK747R	0.7	BAYONET	INS	NON-IRRG	3/4	5 1/2
GK748R	1.0	BAYONET	INS	NON-IRRG	3/4	5 1/2
GK749R	1.3	BAYONET	INS	NON-IRRG	3/4	5 1/2
GK760R	0.4	BAYONET	INS	NON-IRRG	1 3/8	6 1/8
GK761R	0.7	BAYONET	INS	NON-IRRG	1 3/8	6 1/8
GK762R	1.0	BAYONET	INS	NON-IRRG	1 3/8	6 1/8
GK763R	1.3	BAYONET	INS	NON-IRRG	1 3/8	6 1/8
GK764R	0.4	BAYONET	INS	NON-IRRG	2 1/4	6 7/8
GK765R	0.7	BAYONET	INS	NON-IRRG	2 1/4	6 7/8
GK766R	1.0	BAYONET	INS	NON-IRRG	2 1/4	6 7/8
GK767R	1.3	BAYONET	INS	NON-IRRG	2 1/4	6 7/8

* Key:
 INS = Insulating
 NON-IRRG = Non-Irrigating
 IRRG = Irrigating

YASARGIL Style Bipolar Forceps, Stainless Steel

Catalog Number	Tip Size (mm)	Shape	Insulation	Irrigation	Working Length (in.)	Length (in.)
GK768R	0.4	BAYONET	INS	NON-IRRG	3	7 3/4
GK769R	0.7	BAYONET	INS	NON-IRRG	3	7 3/4
GK770R	1.0	BAYONET	INS	NON-IRRG	3	7 3/4
GK771R	1.3	BAYONET	INS	NON-IRRG	3	7 3/4
GK772R	0.4	BAYONET	INS	NON-IRRG	3 3/4	8 1/2
GK773R	0.7	BAYONET	INS	NON-IRRG	3 3/4	8 1/2
GK774R	1.0	BAYONET	INS	NON-IRRG	3 3/4	8 1/2
GK775R	1.3	BAYONET	INS	NON-IRRG	3 3/4	8 1/2

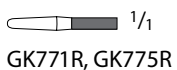
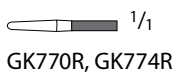
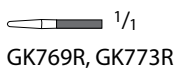
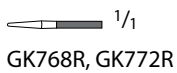
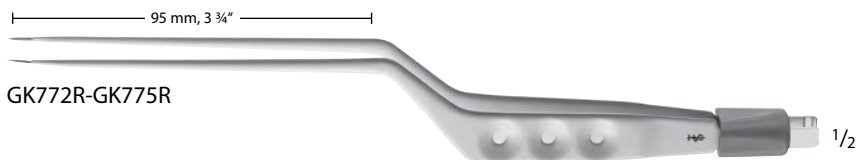

YASARGIL Style Bipolar Forceps, Stainless Steel

Catalog Number	Tip Size (mm)	Shape	Insulation	Irrigation	Working Length (in.)	Length (in.)
GK788R	0.4	BAYONET	INS	NON-IRRIG	4 1/2	9 1/4
GK789R	0.7	BAYONET	INS	NON-IRRIG	4 1/2	9 1/4
GK790R	1.0	BAYONET	INS	NON-IRRIG	4 1/2	9 1/4
GK791R	1.3	BAYONET	INS	NON-IRRIG	4 1/2	9 1/4
GK793R	0.7	BAYONET	INS	NON-IRRIG	5 1/4	10

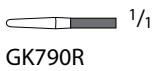
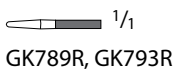
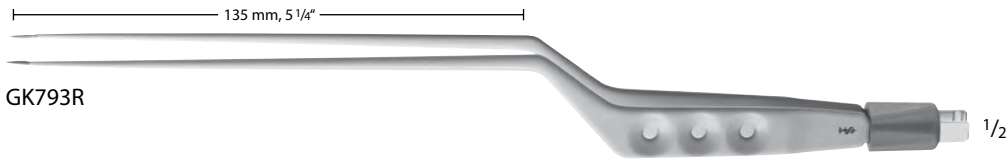
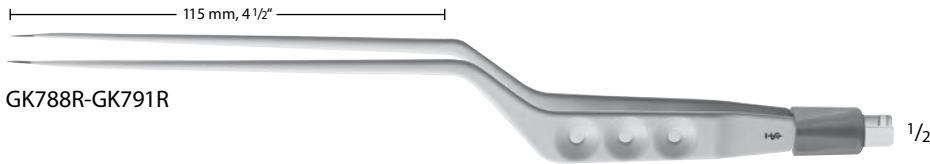

YASARGIL Style Bipolar Forceps, Stainless Steel

Catalog Number	Tip	Tip Size (mm)	Shape	Insulation	Irrigation	Working Length (in.)	Length (in.)
GK777R	45° UP	0.7	BAYONET	INS	NON-IRRIG	3 3/4	8 1/2
GK780R	90° UP	0.4	BAYONET	INS	NON-IRRIG	3 3/4	8 1/2
GK781R	90° UP	0.7	BAYONET	INS	NON-IRRIG	3 3/4	8 1/2
GK785R	90° DOWN	0.7	BAYONET	INS	NON-IRRIG	3 3/4	8 1/2

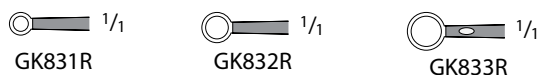
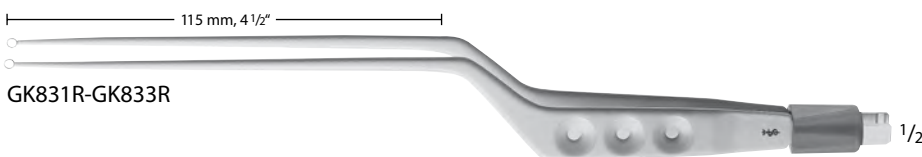
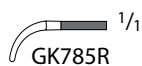
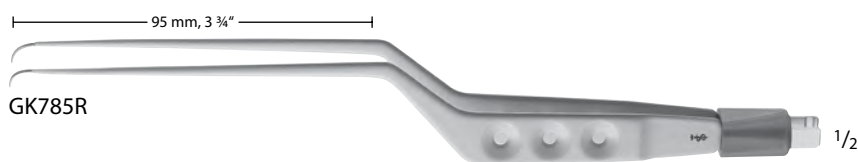
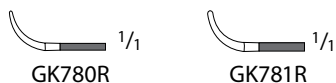
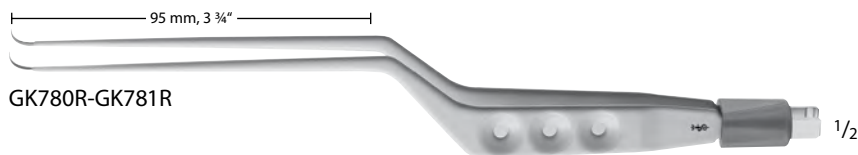
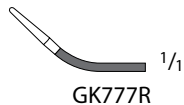
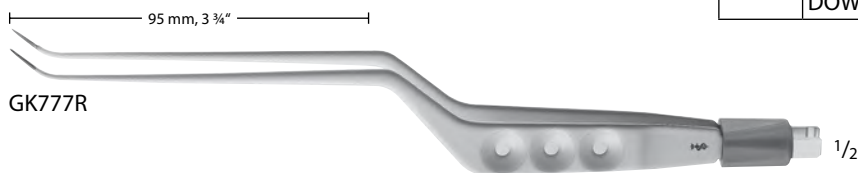

YASARGIL Style Bipolar Forceps

Catalog Number	Tip	Tip Size (mm)	Working Length (in.)	Length (in.)
GK831R	RING	2/3	4 1/2	9 1/4
GK832R	RING	3/4	4 1/2	9 1/4
GK833R	RING	4/5	4 1/2	9 1/4

Bipolar Forceps, Stainless Steel

Catalog Number	Tip Size (mm)	Shape	Insulation	Irrigation	Working Length (in.)	Length (in.)
GK660R	0.6	BAYONET	INS	NON-IRRIG	1 1/2	6 1/4
GK670R	0.6	BAYONET	INS	NON-IRRIG	3 1/8	7 7/8
GK671R	0.9	BAYONET	INS	NON-IRRIG	3 1/8	7 7/8
GK675R	0.6	BAYONET	INS	NON-IRRIG	4	8 3/4
GK677R	0.6	BAYONET	INS	NON-IRRIG	4 3/4	9 1/2
GK679R	0.9	BAYONET	INS	NON-IRRIG	4 3/4	9 1/2

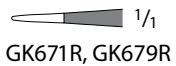
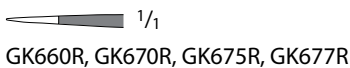

Bayonet Forceps, Rose Gold, Insulated

■ Rose Gold plated tips reduce tissue adhesion



Non-Stick Rose Gold forceps

The Rose Gold forceps enable heat to be quickly discharged away from the tip.



Standard forceps

The heat cannot be discharged fast enough. This leads to overheating and sticking of tissue.

Rose Gold Bipolar Forceps, Bayonet-Shaped

Catalog Number	Tip Size (mm)	Style	Insulation	Irrigation	Working Length (in.)	Length (in.)
US403	0.5	HARDY	INS	NON-IRRG	2	6
US404	0.7	HARDY	INS	NON-IRRG	2	6
US405	1.0	HARDY	INS	NON-IRRG	2	6
US406	1.5	HARDY	INS	NON-IRRG	2	6
US407	2.0	HARDY	INS	NON-IRRG	2	6
US605	0.5	SCOVILLE	INS	NON-IRRG	2 3/4	7 3/4
US606	0.7	SCOVILLE	INS	NON-IRRG	2 3/4	7 3/4
US607	1.0	SCOVILLE	INS	NON-IRRG	2 3/4	7 3/4
US608	1.5	SCOVILLE	INS	NON-IRRG	2 3/4	7 3/4
US609	2.0	SCOVILLE	INS	NON-IRRG	2 3/4	7 3/4
US600	0.5	CUSHING	INS	NON-IRRG	3 1/2	7 1/2
US601	0.7	CUSHING	INS	NON-IRRG	3 1/2	7 1/2
US602	1.0	CUSHING	INS	NON-IRRG	3 1/2	7 1/2
US603	1.5	CUSHING	INS	NON-IRRG	3 1/2	7 1/2
US604	2.0	CUSHING	INS	NON-IRRG	3 1/2	7 1/2
US610	0.5	HARDY	INS	NON-IRRG	4 1/2	8 1/2
US611	0.7	HARDY	INS	NON-IRRG	4 1/2	8 1/2
US612	1.0	HARDY	INS	NON-IRRG	4 1/2	8 1/2
US613	1.5	HARDY	INS	NON-IRRG	4 1/2	8 1/2
US614	2.0	HARDY	INS	NON-IRRG	4 1/2	8 1/2
US615	0.5	HARDY	INS	NON-IRRG	5	9
US616	0.7	HARDY	INS	NON-IRRG	5	9
US617	1.0	HARDY	INS	NON-IRRG	5	9
US618	1.5	HARDY	INS	NON-IRRG	5	9
US619	2.0	HARDY	INS	NON-IRRG	5	9
US530	0.5	HARDY	INS	NON-IRRG	6	10
US620	0.7	HARDY	INS	NON-IRRG	6	10
US621	1.0	HARDY	INS	NON-IRRG	6	10
US173	1.5	HARDY	INS	NON-IRRG	6	10
US531	2.0	HARDY	INS	NON-IRRG	6	10





US173-US621

 1/16
 US403, US530, US600, US610, US615

 1/8
 US404, US601, US611, US616, US621

 1/4
 US405, US602, US612, US617

 3/16
 US173, US406, US603, US613, US618

 1/2
 US407, US531, US604, US614, US619

Rose Gold Microform Bipolar Forceps

Catalog Number	Tip Size (mm)	Shape	Insulation	Irrigation	Working Length (in.)	Length (in.)
US526	0.5	BAYONET	INS	NON-IRRG	1 3/8	6
US527	0.7	BAYONET	INS	NON-IRRG	1 3/8	6
US528	1.0	BAYONET	INS	NON-IRRG	1 3/8	6
US529	1.3	BAYONET	INS	NON-IRRG	1 3/8	6
US570	0.5	BAYONET	INS	NON-IRRG	2 3/8	7
US571	0.7	BAYONET	INS	NON-IRRG	2 3/8	7
US572	1.0	BAYONET	INS	NON-IRRG	2 3/8	7
US573	1.3	BAYONET	INS	NON-IRRG	2 3/8	7
US574	0.5	BAYONET	INS	NON-IRRG	3	7 3/4
US575	0.7	BAYONET	INS	NON-IRRG	3	7 3/4
US576	1.0	BAYONET	INS	NON-IRRG	3	7 3/4
US577	1.3	BAYONET	INS	NON-IRRG	3	7 3/4
US578	0.5	BAYONET	INS	NON-IRRG	3 3/4	8 1/2
US579	0.7	BAYONET	INS	NON-IRRG	3 3/4	8 1/2
US580	1.0	BAYONET	INS	NON-IRRG	3 3/4	8 1/2
US581	1.3	BAYONET	INS	NON-IRRG	3 3/4	8 1/2
US582	0.5	BAYONET	INS	NON-IRRG	4 1/2	9 1/4
US583	0.7	BAYONET	INS	NON-IRRG	4 1/2	9 1/4
US584	1.0	BAYONET	INS	NON-IRRG	4 1/2	9 1/4
US585	1.3	BAYONET	INS	NON-IRRG	4 1/2	9 1/4
US586	0.5	BAYONET	INS	NON-IRRG	5 1/2	10 1/4
US587	0.7	BAYONET	INS	NON-IRRG	5 1/2	10 1/4
US588	1.0	BAYONET	INS	NON-IRRG	5 1/2	10 1/4
US589	1.3	BAYONET	INS	NON-IRRG	5 1/2	10 1/4



Rose Gold Reverse Action Bipolar Forceps

Catalog Number	Tip Size (mm)	Shape	Insulation	Irrigation	Working Length (in.)	Length (in.)
US547	0.7	BAYONET	INS	NON-IRRG	6	10
US548	1.0	BAYONET	INS	NON-IRRG	6	10



Rose Gold Minimally Invasive (MIS) Forceps

Catalog Number	Tip	Tip Size (mm)	Shape	Insulation	Irrigation	Working Length (in.)	Length (in.)
US541	STR	0.7	BAYONET	INS	NON-IRRG	5 1/4	9 1/2
US542	STR	1.2	BAYONET	INS	NON-IRRG	5 1/4	9 1/2
US543	STR	0.7	BAYONET	INS	NON-IRRG	6 1/4	10 1/2
US544	STR	1.2	BAYONET	INS	NON-IRRG	6 1/4	10 1/2
US545	45° UP	0.7	BAYONET	INS	NON-IRRG	5 1/4	9 1/2
US546	45° UP	0.7	BAYONET	INS	NON-IRRG	6 1/4	10 1/2



Rose Gold SEMKIN Bipolar Forceps

Catalog Number	Tip Size (mm)	Shape	Insulation	Irrigation	Length (in.)
US413	1.5	STR	INS	NON-IRRG	6



SCOVILLE Bipolar Forceps, Stainless Steel

Catalog Number	Tip Size (mm)	Shape	Insulation	Irrigation	Working Length (in.)	Length (in.)
US534	1.0	BAYONET	INS	NON-IRRG	2 3/4	7 3/4
US301	1.5	BAYONET	INS	NON-IRRG	2 3/4	7 3/4
US300	1.5	BAYONET	NON-INS	NON-IRRG	2 3/4	7 3/4



GERALD Bipolar Forceps, Stainless Steel

Catalog Number	Tip Size (mm)	Shape	Insulation	Irrigation	Working Length (in.)	Length (in.)
US342	1.0	BAYONET	INS	NON-IRRG	3 1/2	7 1/2
US307	1.0	BAYONET	NON-INS	NON-IRRG	3 1/2	7 1/2



CUSHING Bipolar Forceps, Stainless Steel

Catalog Number	Tip Size (mm)	Shape	Insulation	Irrigation	Working Length (in.)	Length (in.)
US308	0.7	BAYONET	INS	NON-IRRG	3 1/2	7 1/2
US182	1.0	BAYONET	INS	NON-IRRG	3 1/2	7 1/2
US183	1.5	BAYONET	INS	NON-IRRG	3 1/2	7 1/2
US305	2.0	BAYONET	INS	NON-IRRG	3 1/2	7 1/2

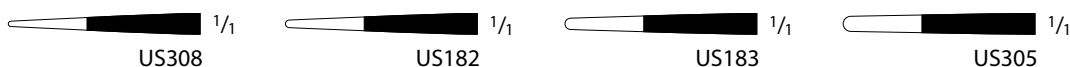

HARDY Bipolar Forceps, Stainless Steel

Catalog Number	Tip Size (mm)	Shape	Insulation	Irrigation	Working Length (in.)	Length (in.)
US310	0.5	BAYONET	INS	NON-IRRG	4 1/2	8 1/2
US536	0.7	BAYONET	INS	NON-IRRG	4 1/2	8 1/2
US184	1.0	BAYONET	INS	NON-IRRG	4 1/2	8 1/2
US185	1.5	BAYONET	INS	NON-IRRG	4 1/2	8 1/2
US186	2.0	BAYONET	INS	NON-IRRG	4 1/2	8 1/2
US187	0.5	BAYONET	INS	NON-IRRG	6	10
US188	1.0	BAYONET	INS	NON-IRRG	6	10
US189	1.5	BAYONET	INS	NON-IRRG	6	10



US184-US189, US310, US536

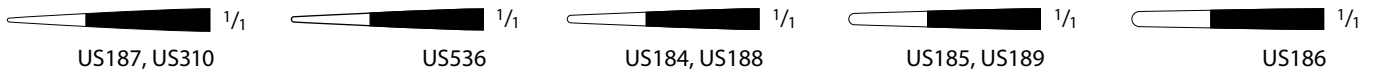

US187, US310

US536

US184, US188

US185, US189

US186

HARDY Bipolar Forceps, Stainless Steel

Catalog Number	Tip Size (mm)	Shape	Insulation	Irrigation	Working Length (in.)	Length (in.)
US309	0.5	BAYONET	NON-INS	NON-IRRG	4 1/2	8 1/2



US309



US309

BARRÉ BipoJET® Nerve/Tissue Sparing Bipolar Forceps,
 Stainless Steel

Catalog Number	Tip Size (mm)	Shape	Insulation	Irrigation	Length (in.)
GK685R	3.0	BAYONET	INS	NON-IRRG	10 1/4



Strong Tension Bipolar Forceps, Stainless Steel

Catalog Number	Tip Size (mm)	Shape	Insulation	Irrigation	Working Length (in.)	Length (in.)
US314	0.5	BAYONET	NON-INS	NON-IRRG	2 3/8	6 1/4
US315	0.7	BAYONET	NON-INS	NON-IRRG	2 3/8	6 1/4
US316	1.0	BAYONET	NON-INS	NON-IRRG	2 3/8	6 1/4
US317	1.3	BAYONET	NON-INS	NON-IRRG	2 3/8	6 1/4
US318	0.5	BAYONET	NON-INS	NON-IRRG	3 1/4	7 1/8
US319	0.7	BAYONET	NON-INS	NON-IRRG	3 1/4	7 1/8
US320	1.0	BAYONET	NON-INS	NON-IRRG	3 1/4	7 1/8
US321	1.3	BAYONET	NON-INS	NON-IRRG	3 1/4	7 1/8
US322	0.5	BAYONET	NON-INS	NON-IRRG	4	7 7/8
US323	0.7	BAYONET	NON-INS	NON-IRRG	4	7 7/8
US324	1.0	BAYONET	NON-INS	NON-IRRG	4	7 7/8
US325	1.3	BAYONET	NON-INS	NON-IRRG	4	7 7/8



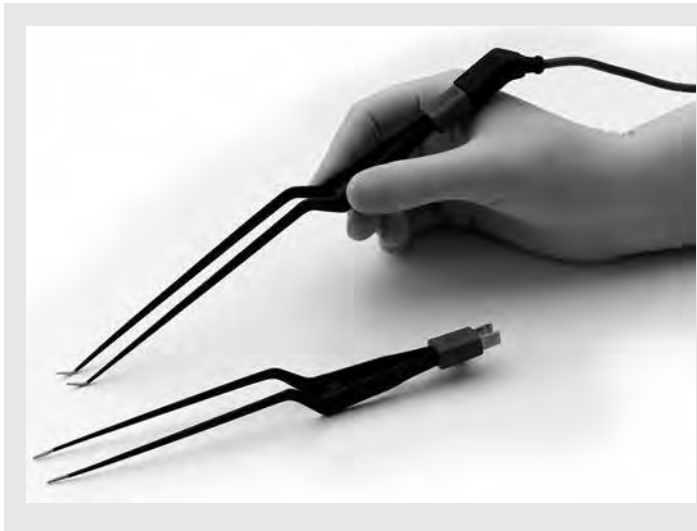

CASPAR Style Bipolar Forceps:

- Developed for precision neurosurgery with a special focus on spine surgery.
- Parallel guiding handle for exact tip alignment.

CASPAR Style Bipolar Forceps, Stainless Steel

Catalog Number	Tip Size (mm)	Shape	Insulation	Irrigation	Working Length (in.)	Length (in.)
GK899R	0.2	BAYONET	INS	NON-IRRG	2 3/4	6 1/2
GK900R	0.5	BAYONET	INS	NON-IRRG	2 3/4	6 1/2
GK910R	1.0	BAYONET	INS	NON-IRRG	2 3/4	6 1/2
GK920R	2.0	BAYONET	INS	NON-IRRG	2 3/4	6 1/2
GK929R	0.2	BAYONET	INS	NON-IRRG	4	7 3/4
GK930R	0.5	BAYONET	INS	NON-IRRG	4	7 3/4
GK940R	1.0	BAYONET	INS	NON-IRRG	4	7 3/4
GK950R	2.0	BAYONET	INS	NON-IRRG	4	7 3/4
GK959R	0.2	BAYONET	INS	NON-IRRG	5	8 3/4
GK960R	0.5	BAYONET	INS	NON-IRRG	5	8 3/4
GK970R	1.0	BAYONET	INS	NON-IRRG	5	8 3/4
GK980R	2.0	BAYONET	INS	NON-IRRG	5	8 3/4

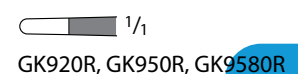
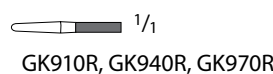
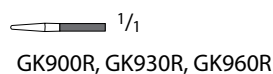
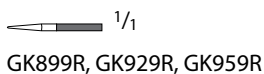

CASPAR Style Bipolar Forceps, Stainless Steel

Catalog Number	Tip	Shape	Tip Size (mm)	Insulation	Irrigation	Working Length (in.)	Length (in.)
GK976R	90° UP	BAYONET	1.0	INS	NON-IRRG	4 3/4	8 1/2
GK978R	90° DOWN	BAYONET	1.0	INS	NON-IRRG	4 3/4	8 1/2
GK972R	45° UP	BAYONET	1.0	INS	NON-IRRG	5	8 3/4
GK974R	45° DOWN	BAYONET	1.0	INS	NON-IRRG	5	8 3/4

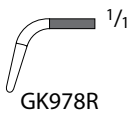
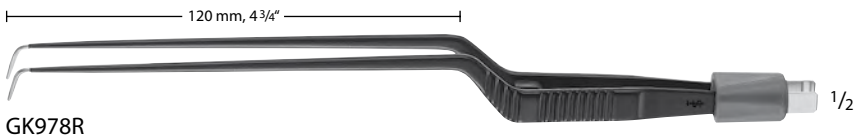
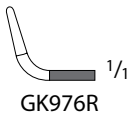
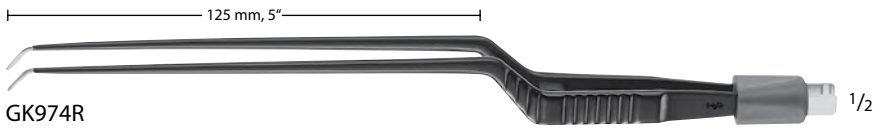
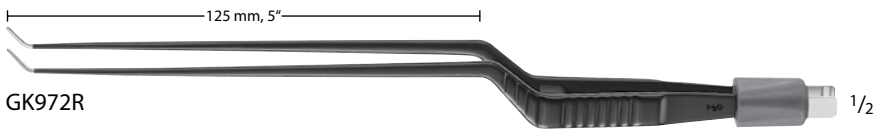

Let Us know if you could not find what you are looking for

SINTRAM Bipolar Forceps

Catalog Number	Tip	Tip Size (mm)	Shape	Insulation	Irrigation	Working Length (in.)	Length (in.)
GK644R	STR	0.7 x 6	BAYONET	INS	NON-IRRG	2 3/8	6 1/4
GK645R	STR	1.0 x 6	BAYONET	INS	NON-IRRG	3 1/4	7 1/4
GK646R	STR	1.0 x 6	BAYONET	INS	NON-IRRG	4	7 7/8
GK614R	STR	0.7 x 23	BAYONET	INS	NON-IRRG	2 3/8	6 1/4
GK615R	STR	1.0 x 23	BAYONET	INS	NON-IRRG	3 1/4	7 1/4
GK616R	STR	1.0 x 23	BAYONET	INS	NON-IRRG	4	7 7/8
GK604R	STR	0.9 x 23	STR	INS	NON-IRRG	-	6 1/4
GK605R	STR	0.9 x 23	STR	INS	NON-IRRG	-	7 1/4
GK606R	STR	0.9 x 23	STR	INS	NON-IRRG	-	7 7/8
GK624R	ANG 35°	0.9 x 23	STR	INS	NON-IRRG	-	6 1/4
GK625R	ANG 35°	0.9 x 23	STR	INS	NON-IRRG	-	7 7/8

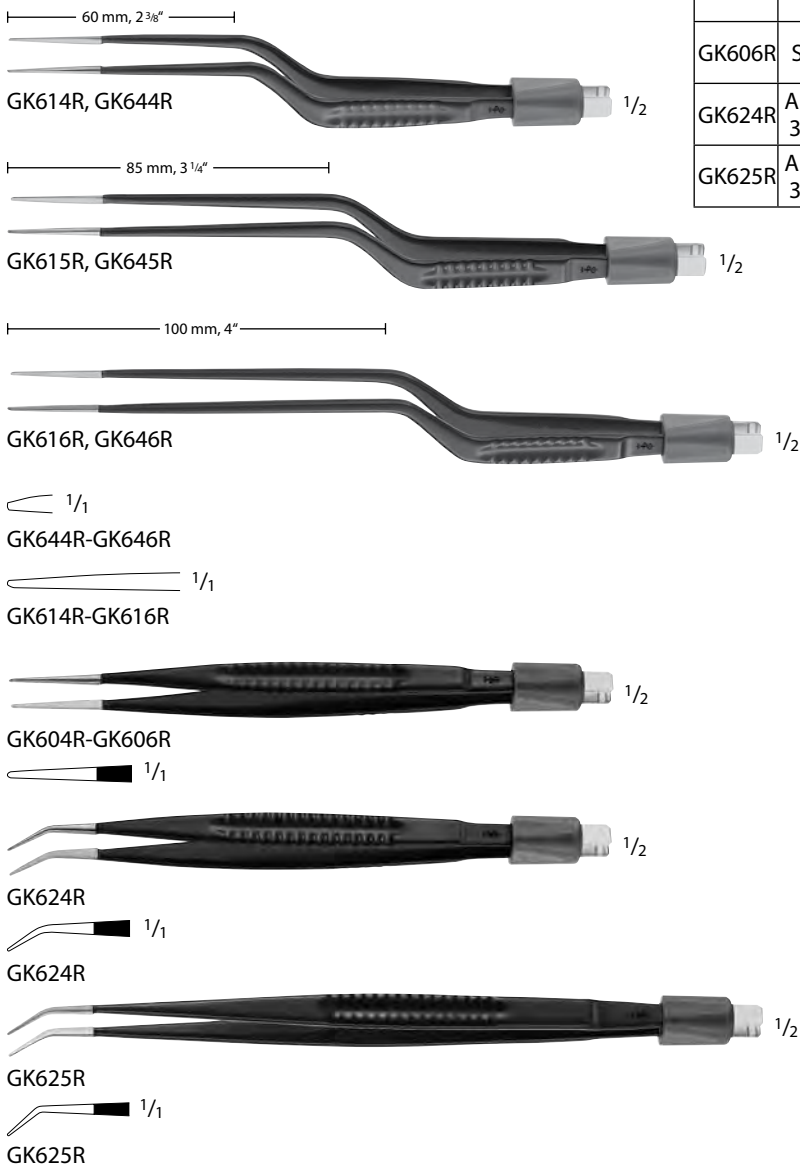

MALIS Style Titanium Bipolar Forceps

Catalog Number	Tip	Tip Size (mm)	Shape	Insulation	Irrigation	Working Length (in.)	Length (in.)
US331	STR	0.5	BAYONET	NON-INS	NON-IRRG	3 3/4	8 3/4
US332	STR	1.0	BAYONET	NON-INS	NON-IRRG	3 3/4	8 3/4
US330	STR	1.5	BAYONET	NON-INS	NON-IRRG	3 3/4	8 3/4
US333	ANG-UP	0.5	BAYONET	NON-INS	NON-IRRG	3 3/4	8 3/4
US175	ANG-DOWN	0.5	BAYONET	NON-INS	NON-IRRG	3 3/4	8 3/4



US330-US332



US330-US332



US175, US333



US175, US333

MALIS Style Rose Gold Bipolar Forceps

Catalog Number	Tip	Tip Size (mm)	Shape	Insulation	Irrigation	Working Length (in.)	Length (in.)
US161	STR	0.5	BAYONET	INS	NON-IRRG	3 3/4	8 3/4
US162	STR	1.0	BAYONET	INS	NON-IRRG	3 3/4	8 3/4
US163	STR	1.5	BAYONET	INS	NON-IRRG	3 3/4	8 3/4
US164	ANG-UP	0.5	BAYONET	INS	NON-IRRG	3 3/4	8 3/4
US165	ANG-DOWN	0.5	BAYONET	INS	NON-IRRG	3 3/4	8 3/4



US161-US165



US161



US162



US163



US164



US165

Titanium Bipolar Forceps

Catalog Number	Tip	Tip Size (mm)	Shape	Insulation	Irrigation	Length (in.)
US326	STR	0.5	STR	NON-INS	NON-IRRG	6
US328	STR	0.5	STR	NON-INS	NON-IRRG	7 1/8
US327	CVD	0.5	STR	NON-INS	NON-IRRG	6
US329	CVD	0.5	STR	NON-INS	NON-IRRG	7 1/8



US326, US328



US327, US329

Micro Bipolar Forceps, Stainless Steel

Catalog Number	Tip	Tip Size (mm)	Shape	Irrigation	Insulation	Length (in.)
US345	STR	0.7	STR	NON-INS	NON-IRRG	6
US347	STR	0.7	STR	NON-INS	NON-IRRG	7 1/8
US346	CVD	0.7	STR	NON-INS	NON-IRRG	6
US348	CVD	0.7	STR	NON-INS	NON-IRRG	7 1/8



US345, US347



US346, US348



GK700R-GK703R



GK700R, GK701R, GK703R



GK711R-GK713R



GK711R, GK713R

Classic Bipolar Forceps, Stainless Steel

Catalog Number	Tip	Tip Size (mm)	Shape	Insulation	Irrigation	Length (in.)
GK700R	STR	0.6	STR	INS	NON-IRRG	6 1/4
GK701R	STR	0.9	STR	INS	NON-IRRG	6 1/4
GK703R	STR	0.9	STR	INS	NON-IRRG	7 7/8
GK711R	ANG-DOWN	0.9	STR	INS	NON-IRRG	6 1/4
GK713R	ANG-DOWN	0.9	STR	INS	NON-IRRG	7 7/8

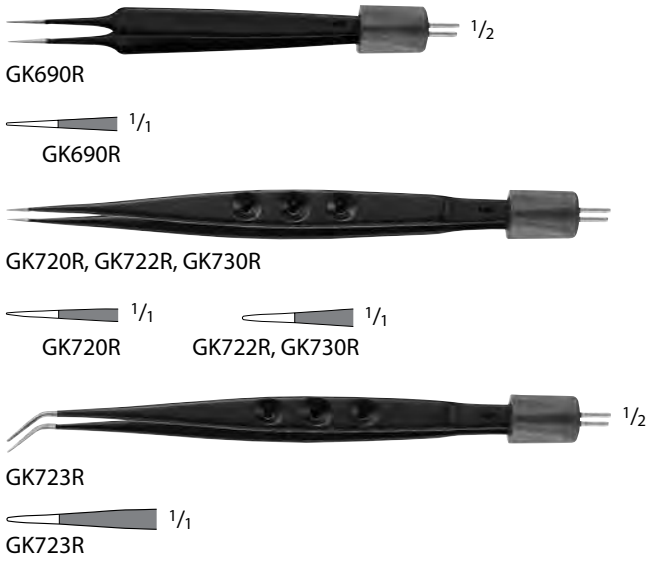

Classic Bipolar Forceps, Stainless Steel

Catalog Number	Tip	Tip Size (mm)	Shape	Insulation	Irrigation	Length (in.)
GK690R	STR	0.4	STR	INS	NON-IRRG	4 3/4
GK720R	STR	0.6	STR	INS	NON-IRRG	6 1/4
GK722R	STR	0.9	STR	INS	NON-IRRG	6 1/4
GK730R	STR	0.9	STR	INS	NON-IRRG	7 7/8
GK723R	ANG-DOWN	0.9	STR	INS	NON-IRRG	6 1/4

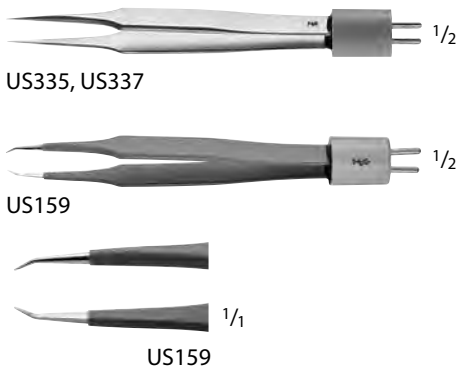

Jewelers Bipolar Forceps, Stainless Steel

Catalog Number	Tip	Tip Size (mm)	Shape	Insulation	Irrigation	Length (in.)
US337	STR	0.4	STR	INS	NON-IRRG	4
US335	STR	0.4	STR	NON-INS	NON-IRRG	4
US159	CVD	0.4	STR	INS	NON-IRRG	4
US336	CVD	0.4	STR	NON-INS	NON-IRRG	4

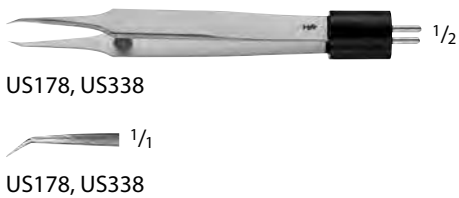

TENZEL Bipolar Forceps, Stainless Steel

Catalog Number	Tip	Tip Size (mm)	Shape	Insulation	Irrigation	Length (in.)
US178	CVD	0.4	STR	INS	NON-IRRG	4
US338	CVD	0.4	STR	NON-INS	NON-IRRG	4



US339-US340

ADSON Bipolar Forceps, Stainless Steel

Catalog Number	Tip	Tip Size (mm)	Shape	Insulation	Irrigation	Length (in.)
US340	STR	1.0	STR	INS	NON-IRRG	5
US339	STR	1.0	STR	NON-INS	NON-IRRG	5



US179-US344

SEMKIN Bipolar Forceps, Stainless Steel

Catalog Number	Tip Size (mm)	Shape	Insulation	Irrigation	Length (in.)
US179	0.7	STR	INS	NON-IRRG	5 1/2
US311	0.7	STR	NON-INS	NON-IRRG	5 1/2
US344	2.0	STR	INS	NON-IRRG	6
US196	2.0	STR	NON-INS	NON-IRRG	6

CUSHING Bipolar Forceps, Stainless Steel

Catalog Number	Tip Size (mm)	Shape	Insulation	Irrigation	Length (in.)
US197	0.7	STR	INS	NON-IRRG	6
US302	0.7	STR	NON-INS	NON-IRRG	6
US304	1.5	STR	INS	NON-IRRG	7
US303	1.5	STR	NON-INS	NON-IRRG	7



US197-US304

GERALD Bipolar Forceps, Stainless Steel

Catalog Number	Tip	Shape	Insulation	Irrigation	Length (in.)
US341	STR	STR	INS	NON-IRRG	7
US306	STR	STR	NON-INS	NON-IRRG	7



US306-US341



US171



US171



US172



US172

Rose Gold Bipolar Forceps

Catalog Number	Tip Size (mm)	Shape	Style	Insulation	Irrigation	Length (in.)
US171	1.0	STR	ADSON	INS	NON-IRRG	5
US172	0.4	STR	JEWELERS	INS	NON-IRRG	4



US176-US177



US176-US177

MALIS Style Titanium Bipolar Forceps

Catalog Number	Tip Size (mm)	Shape	Insulation	Irrigation	Length (in.)
US176	0.25	STR	NON-INS	NON-IRRG	6
US177	0.5	STR	NON-INS	NON-IRRG	6



GK595R-GK596R



GK595R



GK596R



GK597R



GK597R

Micro and Laboratory Forceps, Stainless Steel

Catalog Number	Tip	Tip Size (mm)	Shape	Insulation	Irrigation	Length (in.)
GK596R	STR	0.3	STR	INS	NON-IRRG	5 3/4
GK595R	STR	0.6	STR	INS	NON-IRRG	4 3/4
GK597R	CVD	0.6	STR	INS	NON-IRRG	4 1/4

BiProtect®
 Ceramic Insulated Tip, Insulated

- Ceramic tip insulation helps ensure that heat concentrates on the inner and distal part of the forceps
 - Less collateral damage and reduced thermal spread
 - Partially insulated tip allows for precise and safe surface coagulation

YASARGIL BiProtect Ceramic Insulated Tip Forceps

Catalog Number	Tip	Tip Size (mm)	Shape	Insulation	Irrigation	Working Length (in.)	Length (in.)
GL470R	STR	0.4	BAYONET	INS	NON-IRRG	3 1/2	7 3/4
GL471R	STR	0.8	BAYONET	INS	NON-IRRG	3 1/2	7 3/4
GL480R	STR	0.4	BAYONET	INS	NON-IRRG	4 1/2	8 1/2
GL481R	STR	0.8	BAYONET	INS	NON-IRRG	4 1/2	8 1/2



GL470R-GL481R



GL470R, GL480R



GL471R, GL481R

Transnasal Bipolar Forceps, Stainless Steel

Catalog Number	Tip Size (mm)	Shape	Insulation	Irrigation	Working Length (in.)	Length (in.)
GK719R	1.0	ANG	INS	NON-IRRG	5 1/8	8 1/2



GK719R



GK719R



Let Us know if you could not find what you are looking for

MIN Instruments, Pivot-Point Bipolar Forceps, Transnasal

Catalog Number	Tip	Tip Size (mm)	Shape	Working Length (in.)	Length (in.)
GK822R	STR	0.7	BAYONET	3 3/4	8 1/2
GK824R	STR	1.0	BAYONET	3 3/4	8 1/2
GK826R	STR	0.7	BAYONET	5 1/4	10
GK828R	STR	1.0	BAYONET	5 1/4	10
GK823R	CVD	0.7	BAYONET	3 3/4	8 1/2
GK825R	CVD	1.0	BAYONET	3 3/4	8 1/2
GK827R	CVD	0.7	BAYONET	5 1/4	10
GK829R	CVD	1.0	BAYONET	5 1/4	10

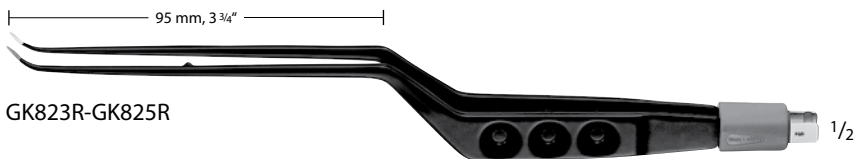
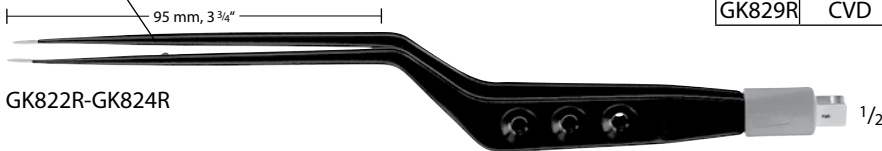

Special pin between the branches opens the tip of the forceps by additional compression of the handle, allowing secure coagulation in narrow and deep seated surgical fields.

1/1

GK822R, GK823R, GK826R, GK827R



1/1

GK824R, GK825R, GK828R, GK829R

LANDOLT Bipolar Forceps, Stainless Steel

Catalog Number	Tip	Insulation	Irrigation	Description	Working Length (in.)
GK560R	ANG 90°	INS	NON-IRRIG	COAGULATION FORCEPS F/ HYPOPHYSECTOMY	6
GK561R	90°	-	-	SPARE INNER PART F/ GK560R	
GK580R	ANG 120°	INS	NON-IRRIG	COAGULATION FORCEPS F/ HYPOPHYSECTOMY	6
GK581R	120°	-	-	SPARE INNER PART F/ GK580R	

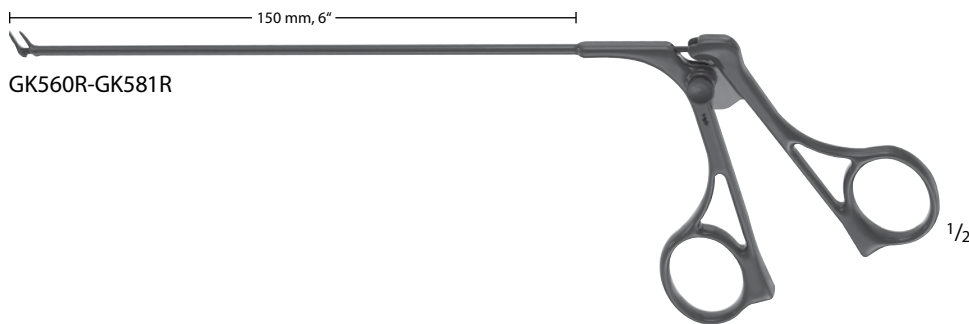

Let Us know if you could not find what you are looking for

■ Irrigating coagulation forceps facilitate gentle coagulation without tissue adhesion.

Rose Gold Irrigating Bipolar Forceps

Catalog Number	Tip Size (mm)	Shape	Insulation	Irrigation	Working Length (in.)	Length (in.)
US622	0.5	BAYONET	INS	IRRG	3 1/2	7 1/2
US623	0.7	BAYONET	INS	IRRG	3 1/2	7 1/2
US624	1.0	BAYONET	INS	IRRG	3 1/2	7 1/2
US625	1.5	BAYONET	INS	IRRG	3 1/2	7 1/2
US626	2.0	BAYONET	INS	IRRG	3 1/2	7 1/2
US627	0.5	BAYONET	INS	IRRG	3	7 3/4
US628	0.7	BAYONET	INS	IRRG	3	7 3/4
US629	1.0	BAYONET	INS	IRRG	3	7 3/4
US630	1.5	BAYONET	INS	IRRG	3	7 3/4
US631	2.0	BAYONET	INS	IRRG	3	7 3/4
US632	0.5	BAYONET	INS	IRRG	4 1/2	8 1/2
US633	0.7	BAYONET	INS	IRRG	4 1/2	8 1/2
US634	1.0	BAYONET	INS	IRRG	4 1/2	8 1/2
US635	1.5	BAYONET	INS	IRRG	4 1/2	8 1/2
US636	2.0	BAYONET	INS	IRRG	4 1/2	8 1/2
US637	0.5	BAYONET	INS	IRRG	5	9
US638	0.7	BAYONET	INS	IRRG	5	9
US639	1.0	BAYONET	INS	IRRG	5	9
US640	1.5	BAYONET	INS	IRRG	5	9
US641	2.0	BAYONET	INS	IRRG	5	9
US532	0.5	BAYONET	INS	IRRG	6	10
US642	0.7	BAYONET	INS	IRRG	6	10
US643	1.0	BAYONET	INS	IRRG	6	10
US174	1.5	BAYONET	INS	IRRG	6	10
US533	2.0	BAYONET	INS	IRRG	6	10



US174-US533

CUSHING Irrigating Bipolar Forceps, Stainless Steel

Catalog Number	Tip Size (mm)	Shape	Insulation	Irrigation	Working Length (in.)	Length (in.)
US369	0.7	BAYONET	INS	IRRG	3 1/2	7 1/2
US190	1.0	BAYONET	INS	IRRG	3 1/2	7 1/2
US191	1.5	BAYONET	INS	IRRG	3 1/2	7 1/2
US370	2.0	BAYONET	INS	IRRG	3 1/2	7 1/2



US190-US370



US190-US370

HARDY Irrigating Bipolar Forceps, Stainless Steel

Catalog Number	Tip Size (mm)	Shape	Insulation	Irrigation	Working Length (in.)	Length (in.)
US366	0.5	BAYONET	INS	IRRG	4 1/2	8 1/2
US382	1.0	BAYONET	INS	IRRG	4 1/2	8 1/2
US385	1.5	BAYONET	INS	IRRG	4 1/2	8 1/2
US192	2.0	BAYONET	INS	IRRG	4 1/2	8 1/2
US193	0.5	BAYONET	INS	IRRG	6	10
US194	1.0	BAYONET	INS	IRRG	6	10
US195	1.5	BAYONET	INS	IRRG	6	10
US558	0.5	BAYONET	NON-INS	IRRG	4 1/2	8 1/2



SCOVILLE Irrigating Bipolar Forceps, Stainless Steel

Catalog Number	Tip Size (mm)	Shape	Insulation	Irrigation	Working Length (in.)	Length (in.)
US367	1.5	BAYONET	INS	IRRG	2 3/4	7 3/4
US556	1.5	BAYONET	NON-INS	IRRG	2 3/4	7 3/4



GERALD Irrigating Bipolar Forceps, Stainless Steel

Catalog Number	Tip Size (mm)	Shape	Insulation	Irrigation	Working Length (in.)	Length (in.)
US368	1.0	BAYONET	INS	IRRG	3 1/2	7 1/2
US557	1.0	BAYONET	NON-INS	IRRG	3 1/2	7 1/2



MALIS Style Titanium Irrigating Bipolar Forceps

Catalog Number	Tip	Tip Size (mm)	Shape	Insulation	Irrigation	Working Length (in.)	Length (in.)
US360	STR	1.5	BAYONET	INS	IRRG	3 3/4	8 3/4
US361	STR	0.5	BAYONET	INS	IRRG	3 3/4	8 3/4
US362	STR	1.0	BAYONET	INS	IRRG	3 3/4	8 3/4
US363	ANG-UP	0.5	BAYONET	INS	IRRG	3 3/4	8 3/4
US372	ANG-DOWN	0.5	BAYONET	INS	IRRG	3 3/4	8 3/4



US360-US362



US360-US362



US363, US372



US363, US372

MALIS Style Rose Gold Irrigating Bipolar Forceps

Catalog Number	Tip	Tip Size (mm)	Shape	Insulation	Irrigation	Working Length (in.)	Length (in.)
US166	STR	0.5	BAYONET	INS	IRRG	3 3/4	8 3/4
US167	STR	1.0	BAYONET	INS	IRRG	3 3/4	8 3/4
US168	STR	1.5	BAYONET	INS	IRRG	3 3/4	8 3/4
US169	ANG-UP	0.5	BAYONET	INS	IRRG	3 3/4	8 3/4
US170	ANG-DOWN	0.5	BAYONET	INS	IRRG	3 3/4	8 3/4



US166-US168



US169-US170

Irrigating Bipolar Forceps, Stainless Steel

Catalog Number	Tip Size (mm)	Shape	Insulation	Irrigation	Working Length (in.)	Length (in.)
GK838R	0.7	BAYONET	INS	IRRG	2	6 1/2
GK840R	0.4	BAYONET	INS	IRRG	2 3/4	7
GK841R	0.7	BAYONET	INS	IRRG	2 3/4	7
GK842R	1.3	BAYONET	INS	IRRG	2 3/4	7
GK843R	0.4	BAYONET	INS	IRRG	3 1/2	8
GK844R	0.7	BAYONET	INS	IRRG	3 1/2	8
GK845R	1.3	BAYONET	INS	IRRG	3 1/2	8
GK846R	0.4	BAYONET	INS	IRRG	4 1/2	9
GK847R	0.7	BAYONET	INS	IRRG	4 1/2	9
GK848R	1.3	BAYONET	INS	IRRG	4 1/2	9

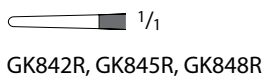
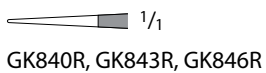
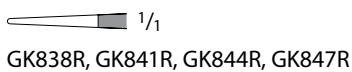
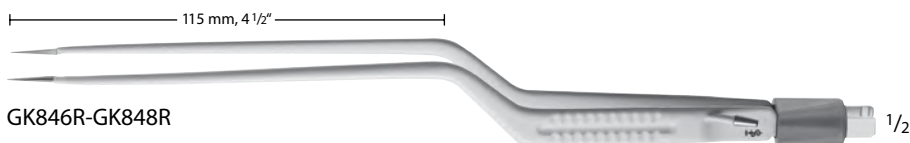
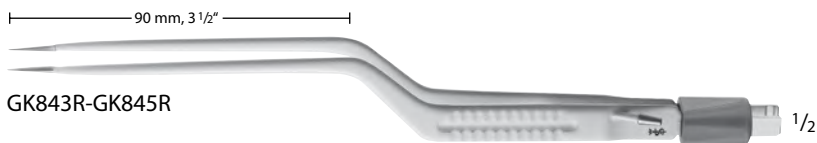

Stainless Steel Disposable Bipolar Forceps, Box of 10

Catalog Number	Tip Size (mm)	Shape	Style	Insulation	Irrigation	Working Length (in.)	Length (in.)
US153SU	1.5	BAYONET	SCOVILLE	INS	NON-IRRG	2 3/4	7 3/4
US567SU	2.0	BAYONET	CUSHING	INS	NON-IRRG	2 3/4	7 3/4
US562SU	0.7	BAYONET	CUSHING	INS	NON-IRRG	3 1/2	7 1/2
US560SU	1.0	BAYONET	GERALD	INS	NON-IRRG	3 1/2	7 1/2
US154SU	0.5	BAYONET	HARDY	INS	NON-IRRG	4 1/2	8 1/2
US155SU	1.0	BAYONET	HARDY	INS	NON-IRRG	4 1/2	8 1/2
US156SU	1.5	BAYONET	HARDY	INS	NON-IRRG	4 1/2	8 1/2
US157SU	2.0	BAYONET	HARDY	INS	NON-IRRG	4 1/2	8 1/2



US153SU-US567SU



US153SU-US567SU



US158SU



US158SU

ADSON Disposable Bipolar Forceps, Stainless Steel, Box of 10

Catalog Number	Tip Size (mm)	Shape	Insulation	Irrigation	Length (in.)
US158SU	1.0	STR	INS	NON-IRRG	5

Disposable Jewelers Bipolar Forceps, Stainless Steel, Box of 10

Catalog Number	Tip Size (mm)	Shape	Insulation	Irrigation	Length (in.)
US568SU	0.4	STR	NON-INS	NON-IRRG	4
US569SU	0.4	STR	INS	NON-IRRG	4



US568SU-US569SU

Rose Gold Disposable Jewelers Bipolar Forceps, Box of 5

Catalog Number	Tip Size (mm)	Shape	Insulation	Irrigation	Length (in.)
US408SU	0.4	STR	INS	NON-IRRG	4
US409SU	1.0	STR	INS	NON-IRRG	5



US408SU-US409SU

Rose Gold Disposable Bipolar Forceps, Box of 5

Catalog Number	Tip Size (mm)	Shape	Style	Insulation	Irrigation	Working Length (in.)	Length (in.)
US565SU	0.7	STR	SEMKIN	INS	NON-IRRG		5 1/2
US559SU	1.5	BAYONET	SCOVILLE	INS	NON-IRRG	2 3/4	7 3/4
US201SU	0.5	BAYONET	CUSHING	INS	NON-IRRG	3 1/2	7 1/2
US561SU	0.7	BAYONET	CUSHING	INS	NON-IRRG	3 1/2	7 1/2
US202SU	1.0	BAYONET	CUSHING	INS	NON-IRRG	3 1/2	7 1/2
US203SU	1.5	BAYONET	CUSHING	INS	NON-IRRG	3 1/2	7 1/2
US566SU	2.0	BAYONET	CUSHING	INS	NON-IRRG	3 1/2	7 1/2
US204SU	0.5	BAYONET	HARDY	INS	NON-IRRG	4 1/2	8 1/2
US563SU	0.7	BAYONET	HARDY	INS	NON-IRRG	4 1/2	8 1/2
US205SU	1.0	BAYONET	HARDY	INS	NON-IRRG	4 1/2	8 1/2
US206SU	1.5	BAYONET	HARDY	INS	NON-IRRG	4 1/2	8 1/2
US564SU	2.0	BAYONET	HARDY	INS	NON-IRRG	4 1/2	8 1/2



US201SU-US564SU



US565SU

Rose Gold Disposable Irrigating Bipolar Forceps, Box of 5

Catalog Number	Tip Size (mm)	Shape	Insulation	Irrigation	Working Length (in.)	Length (in.)
US410SU	0.5	BAYONET	INS	IRRG	4 1/2	8 1/2
US411SU	1.0	BAYONET	INS	IRRG	4 1/2	8 1/2
US412SU	1.5	BAYONET	INS	IRRG	4 1/2	8 1/2



US410SU-US412SU

Stainless Steel Disposable Irrigating Bipolar Forceps, Box of 5

Catalog Number	Tip Size (mm)	Shape	Insulation	Irrigation	Working Length (in.)	Length (in.)
US523SU	0.5	BAYONET	INS	IRRG	4 1/2	8 1/2
US524SU	1.0	BAYONET	INS	IRRG	4 1/2	8 1/2
US525SU	1.5	BAYONET	INS	IRRG	4 1/2	8 1/2



US523SU-US525SU

Specialty Disposable Non-Stick Bipolar Forceps

Catalog Number	Tip Size (mm)	Shape	Insulation	Irrigation	Length (in.)
US501SU	0.5	BAYONET	INS	NON-IRRG	7
US502SU	1.0	BAYONET	INS	NON-IRRG	7
US503SU	1.5	BAYONET	INS	NON-IRRG	7
US504SU	0.5	BAYONET	INS	NON-IRRG	8
US505SU	1.0	BAYONET	INS	NON-IRRG	8
US506SU	1.5	BAYONET	INS	NON-IRRG	8
US507SU	0.5	BAYONET	INS	NON-IRRG	9
US508SU	1.0	BAYONET	INS	NON-IRRG	9
US509SU	1.5	BAYONET	INS	NON-IRRG	9



US501SU-US509SU



US501SU-US509SU

Bipolar Cords for BipoJET™

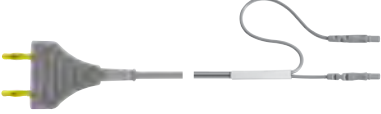
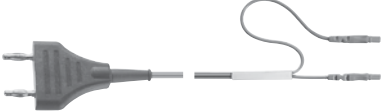
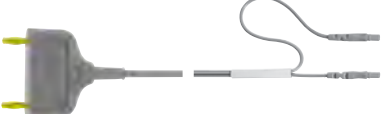
Catalog Number	New Cord	Pin Distance	Compatible Generators
GN145		22 MM	EMC DOLLEX ERBE Int'l MARTIN
GN085		29 MM	VALLEYLAB ERBE
GN146		38 MM	CODMAN CMC II / III ERBE MARTIN



GK195

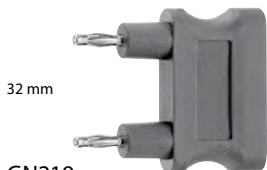

GN219



GN224

LANDOLT Bipolar Cord and Adapters

Catalog Number	Pin Distance (mm)	Description
GK195	28.6	REUSABLE CORD F/ INSULATED LANDOLT FORCEPS
GN219	32	ADAPTER F/ CONMED
GN224	38	ADAPTER F/ CODMAN



US349SP

Dual Bipolar Cord, Sterile Disposable

Catalog Number	Packaging	Length (ft)
US349SP	10/BOX	12



US351

Round Bipolar Cord, Reusable

Catalog Number	Material	Length (ft)
US351	SILICONE	12



US359

Dual Bipolar Cord, Reusable

Catalog Number	Length (ft)
US359	12

Equipment Side

Instrument Side

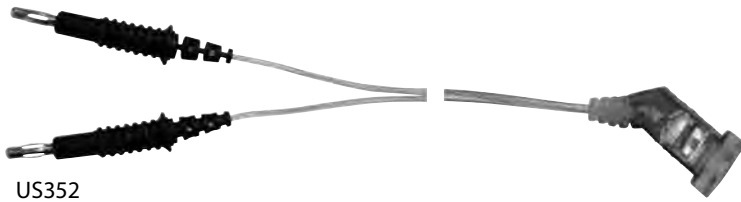

US352



US353

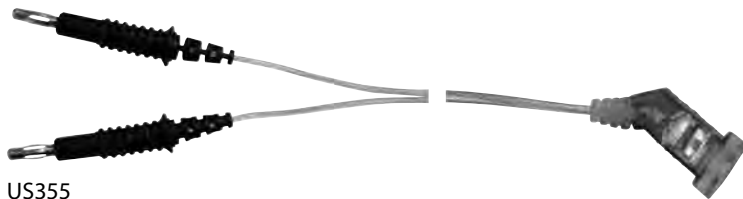

US355

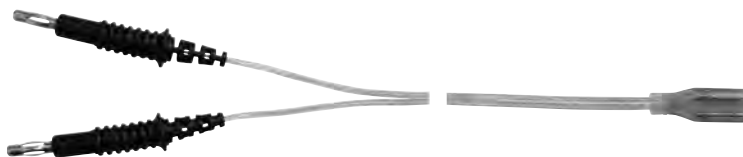

US356

Combined Bipolar and Irrigation Cord

Catalog Number	Pin Type	Packaging	Compatible w/
US352	DUAL	BOX OF 10	-
US353	ROUND	BOX OF 10	-
US355	DUAL	BOX OF 10	MALIS 1000 IRRIGATION SYSTEM
US356	ROUND	BOX OF 10	MALIS 1000 IRRIGATION SYSTEM

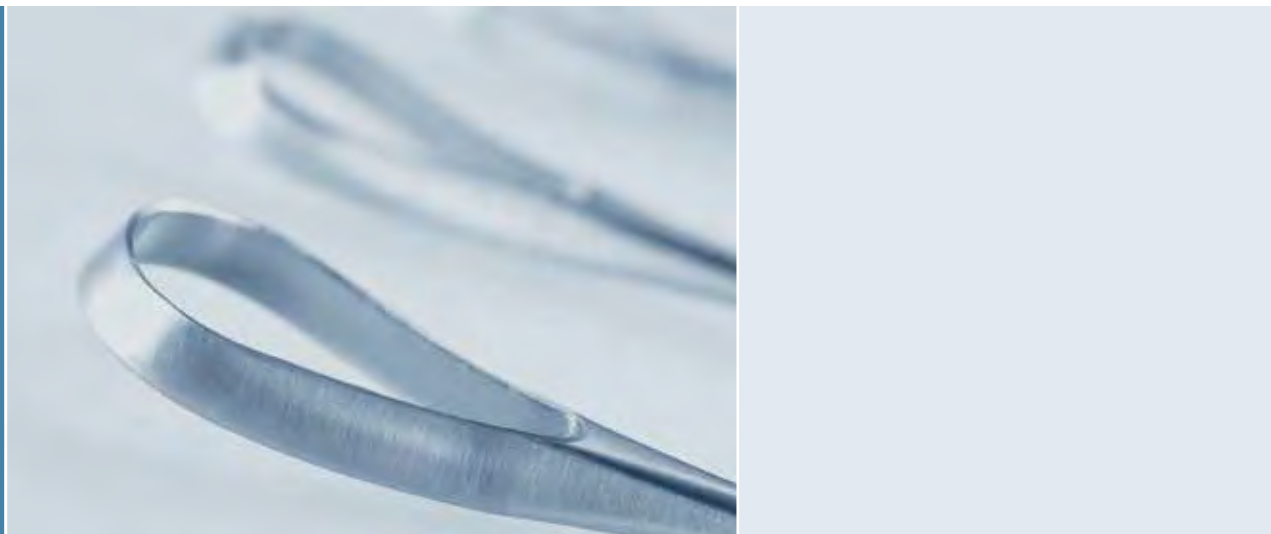

Obstetrics/Gynecology

Scissors	1202 - 1211
Needle Holders	1212
Forceps	1213 - 1250
Clamps	1251 - 1260
Retractors	1261 - 1262
Vaginal Retractors and Specula	1263 - 1281
Endospecula	1282
Dilators and Probes	1283 - 1287
Curettes	1288 - 1294
Accessories	1295



BC731R-MG219R



BC731R



MG219R



BC721R-BC743R

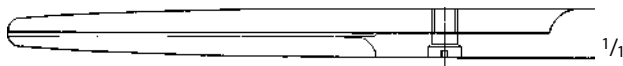

BC721R

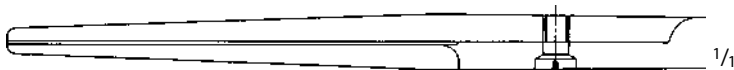

BC723R

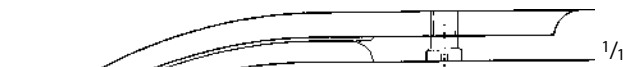

BC741R



BC708R

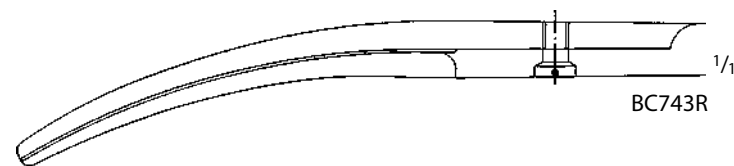

BC743R

SIMS Scissors

Catalog Number	Tip	Blade	Length (in.)
BC731R	S/S	STR	7 7/8
MG219R	S/S	CVD	8

SIMS Scissors

Catalog Number	Tip	Blade	Length (in.)
BC721R	B/B	STR	7 7/8
BC723R	B/B	STR	9
BC741R	B/B	CVD	7 7/8
BC708R	B/B	CVD	8 1/4
BC743R	B/B	CVD	9

SIMS Scissors (continued)

Catalog Number	Tip	Blade	Length (in.)
MG218R	S/B	STR	8
BC746R	S/B	CVD	7 7/8
BC748R	S/B	CVD	9

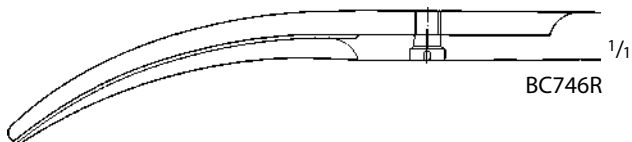
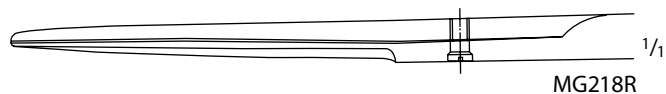



WERTHEIM Scissors

Catalog Number	Tip	Blade	Length (in.)
BC702R	B/B	CVD	5 3/4
BC703R	B/B	CVD	7 7/8
BC704R	B/B	CVD	9

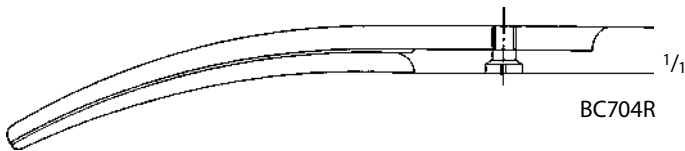

JORGENSEN Scissors

Catalog Number	Tip	Blade	Length (in.)
MD491	B/B	CVD	8 3/4

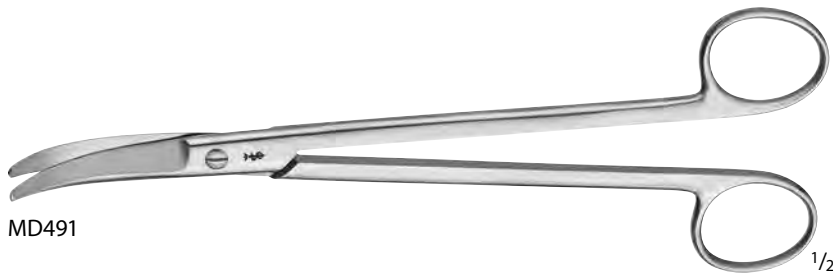

MD491



MD491

SIEBOLD Uterine Scissors

Catalog Number	Tip	Blade	Length (in.)
BC760R	B/B	CVD	9 5/8



BC760R

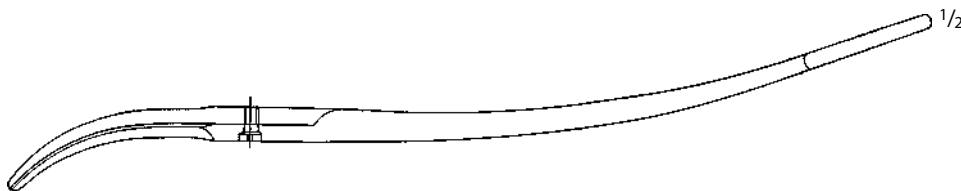

BC760R

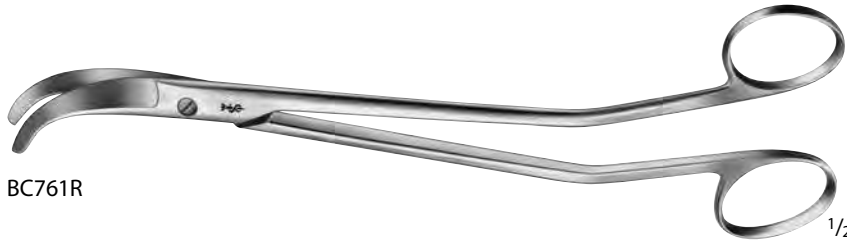

BC761R

1/2

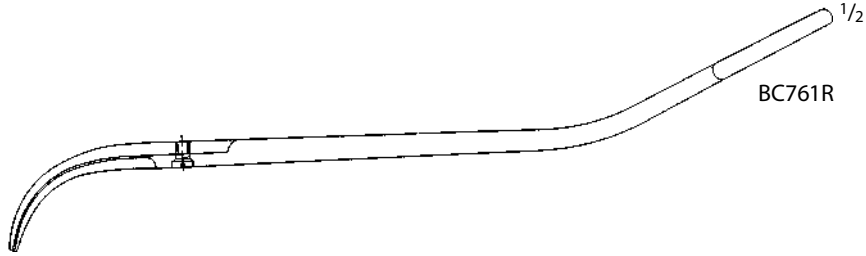

BC761R

BOZEMANN Uterine Scissors

Catalog Number	Tip	Blade	Length (in.)
BC761R	B/B	CVD	8 3/4

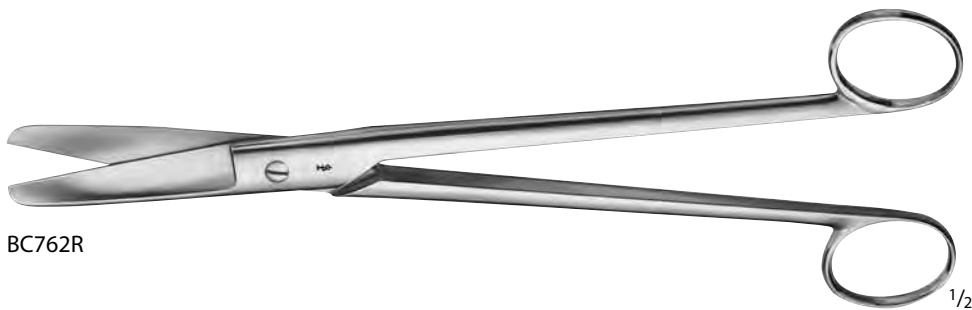

BC762R

1/2



BC762R

SIMS-SIEBOLD Uterine Scissors

Catalog Number	Tip	Blade	Length (in.)
BC762R	B/B	STR	9 3/4



BC558R-BC559R, MB726R, MG215R

DUROTIP TC MAYO Dissecting Scissors

Catalog Number	Tip	Blade	Length (in.)
BC558R	B/B	STR	9
MG215R	B/B	STR	14
BC559R	B/B	CVD	9
MB726R	B/B	CVD	14

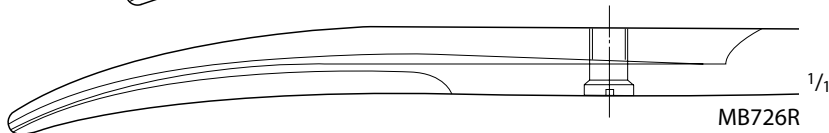
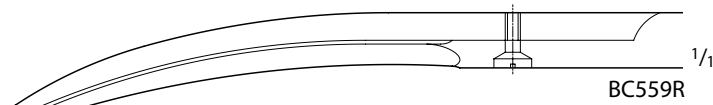
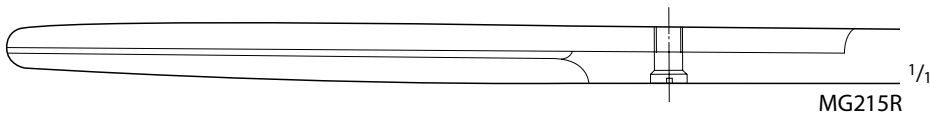
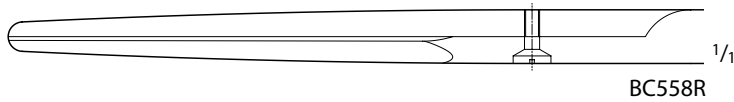

BC290R-BC291R

DUROTIP TC SIMS Uterine Scissors

Catalog Number	Tip	Blade	Length (in.)
BC290R	B/B	CVD	7 7/8
BC291R	B/B	CVD	9

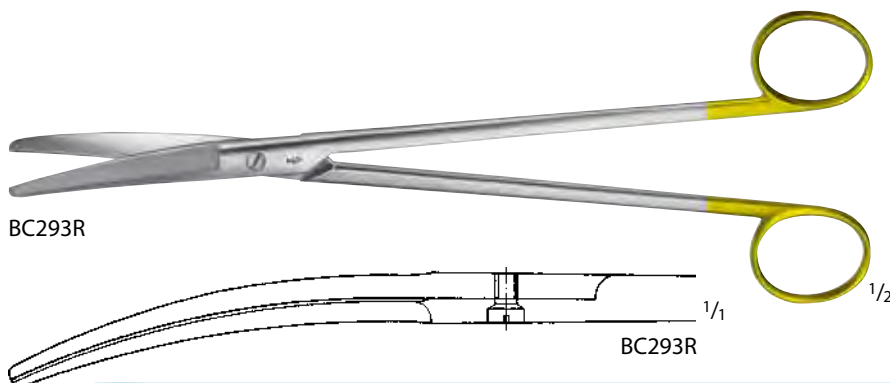
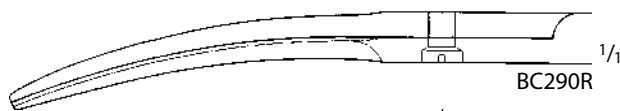

BC293R

DUROTIP TC WERTHEIM Scissors

Catalog Number	Length (in.)
BC293R	9

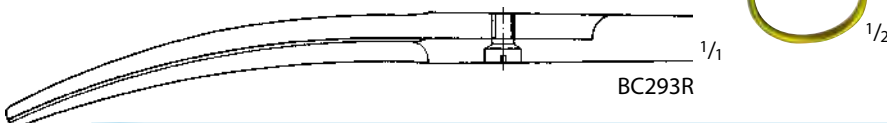



MG208R-MG214R

DUROTIP TC Uterine Scissors

Catalog Number	Tip	Length (in.)
MG208R	SLIGHT CVD	9
MG209R	STRONG CVD	9
MG210R	ANG	9
MG211R	ANG	10 1/2
MG212R	SLIGHT CVD	11 3/4
MG213R	STRONG CVD	11 3/4
MG214R	ANG	11 3/4

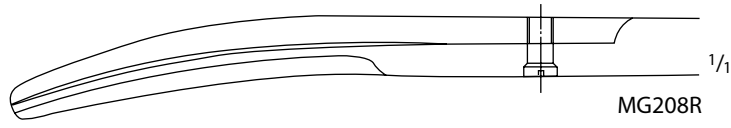

MG208R

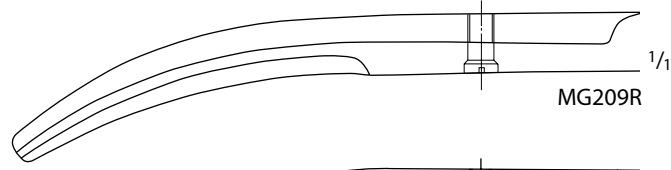

MG209R

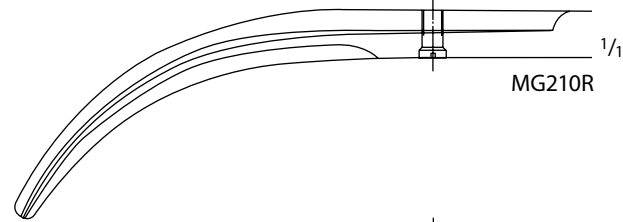

MG210R

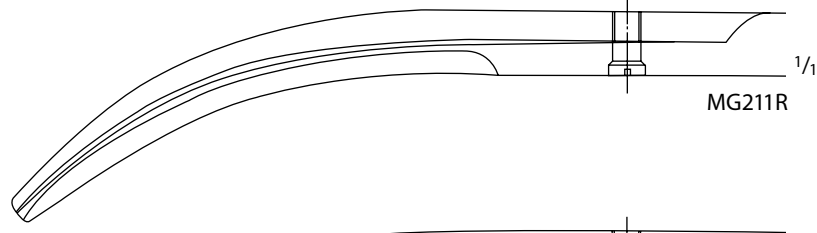

MG211R



MG212R

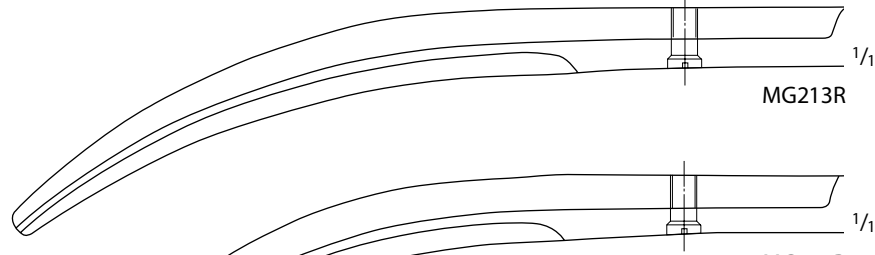

MG213R

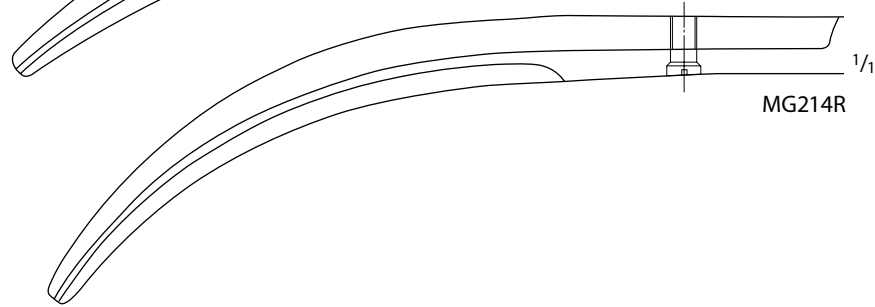

MG214R

Let Us know if you could not find what you are looking for



Wavecut

Wavecut scissors have one serrated cutting edge to help prevent tissue from slipping. The W after the item number indicates the scissors are the wavecut style, e.g. BC211W.



BC290W-BC291W

DUROTIP TC SIMS Uterine Wavecut Scissors

Catalog Number	Tip	Blade	Length (in.)
BC290W	B/B	CVD	7 7/8
BC291W	B/B	CVD	9

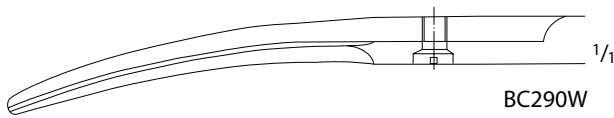

BC290W

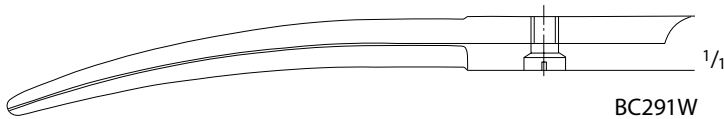

BC291W

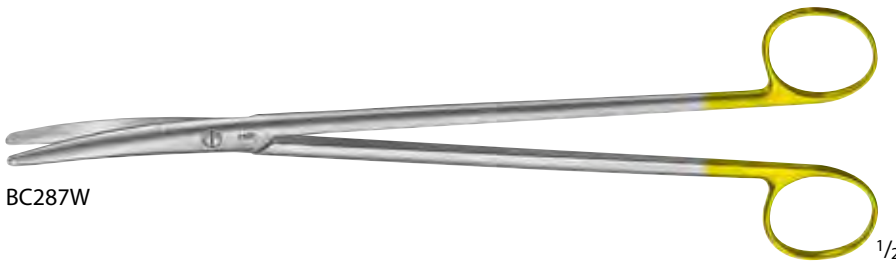

BC287W

DUROTIP TC METZENBAUM Wavecut Dissecting Scissors, Heavy

Catalog Number	Tip	Blade	Length (in.)
BC287W	B/B	CVD	9

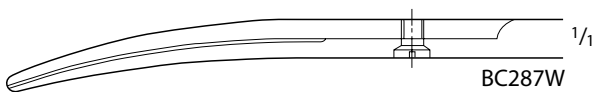

BC287W



BC796R-BC797R

Umbilical Cord Scissors

Catalog Number	Tip	Blade	Length (in.)
BC796R	B/B	LAT-CVD	5 1/4
BC797R	B/B	LAT-CVD	6 1/4

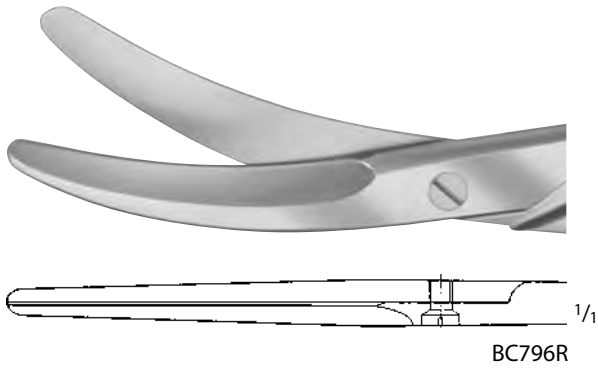

BC796R



BC797R



ET152R

1/2

Umbilical Cord Scissors

Catalog Number	Length (in.)
ET152R	4 1/8

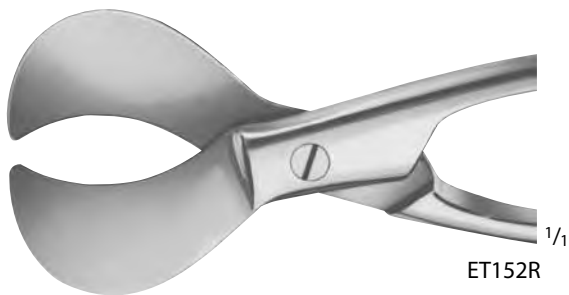

ET152R

SCHUHMACHER Umbilical Cord
 Scissors

Catalog Number	Length (in.)
ET150R	6 1/8

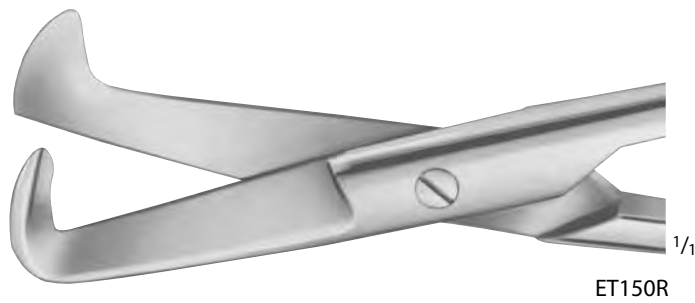
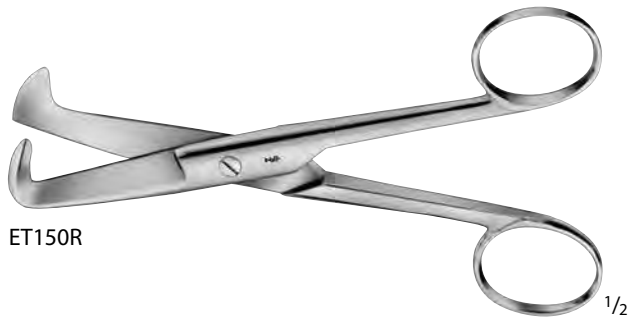

BRAUN-STADLER Episiotomy
 Scissors

Catalog Number	Blade	Length (in.)
ET140R	SERR	5 3/4
ET141R	SERR	7 7/8

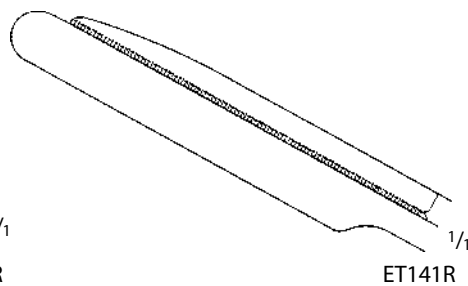
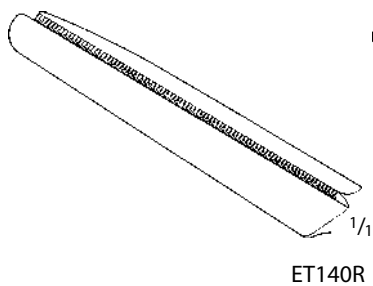

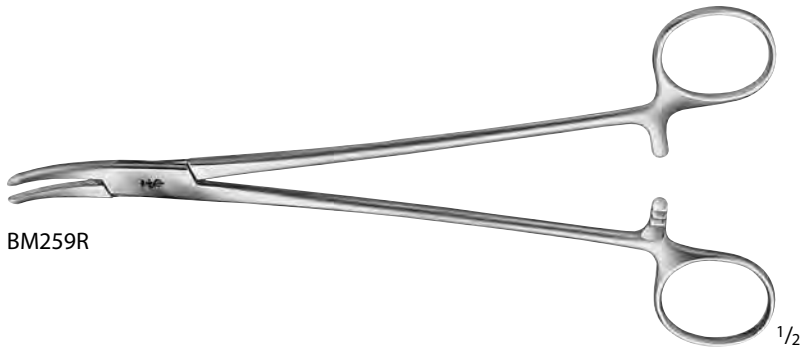

BM259R

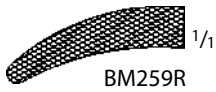

BM259R

A smooth jaw and three different serration patterns are

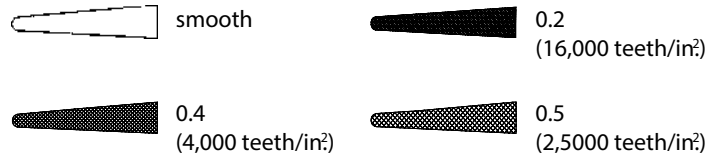
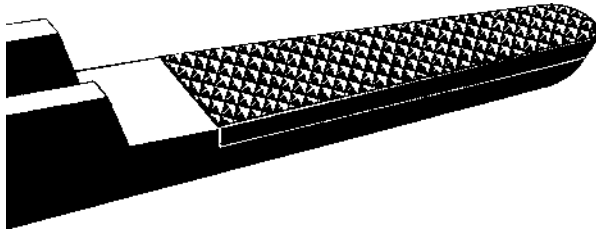

We recommend carbide inserts as follows:

Jaw Surface	Suture Material
Smooth	9/0 - 11/0
0.2 mm pitch of serration	6/0 - 10/0
0.4 mm pitch of serration	4/0 - 6/0
0.5 mm pitch of serration	up to 3/0

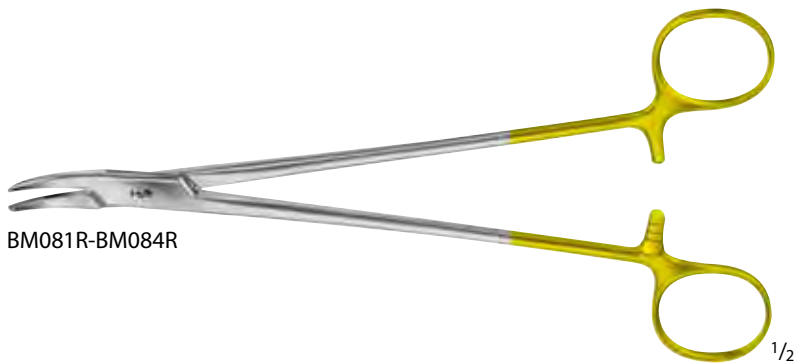

BM081R-BM084R

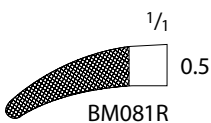

BM081R

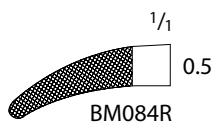

BM084R

HEANEY Needle Holder

Catalog Number	Tip	Jaw	Length (in.)
BM259R	CVD	SERR	7 7/8

DUROGRIP™ TC HEANEY Needle Holder

Catalog Number	Tip	Jaw	Length (in.)
BM081R	CVD	SERR	7 7/8
BM084R	CVD	SERR	10 1/4

MAIER Forceps

Catalog Number	Jaw	Length (in.)
BF056R	STR	10 1/2
BF057R	CVD	10 1/2



BF056R-BF057R



BF056R

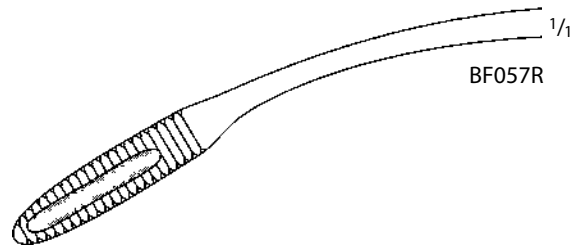

BF057R

MAIER Forceps, W/ Ratchet

Catalog Number	Jaw	Length (in.)
BF058R	STR	10 1/4
BF059R	CVD	10 1/4



BF058R-BF059R



BF058R

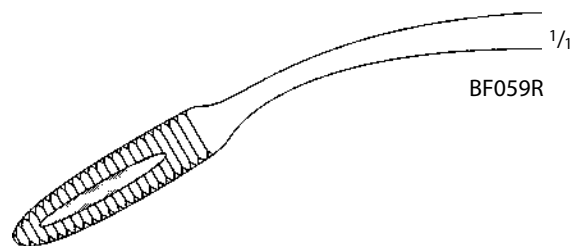

BF059R

SIMS-MAIER Sponge Forceps,
 W/ Ratchet

Catalog Number	Jaw	Length (in.)
BF076R	STR	11
BF077R	CVD	11



BF076R-BF077R



BF076R

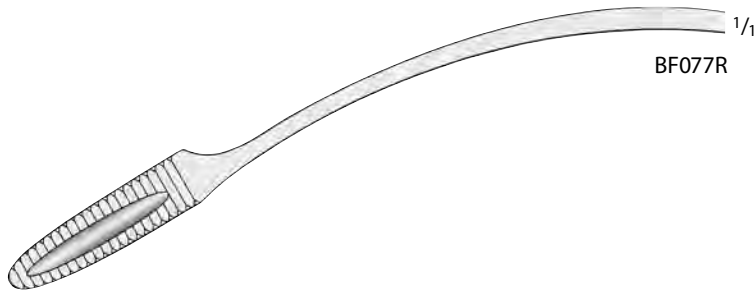

BF077R

PELKMANN Forceps

Catalog Number	Tip	Jaw	Length (in.)
EO060R	SERR	STR	10 1/4
EO061R	SERR	CVD	10 1/4

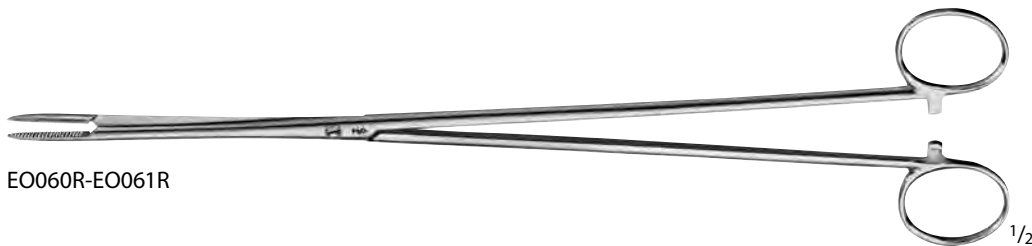

EO060R-EO061R

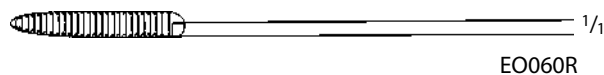

EO060R



EO061R

BOZEMANN Forceps

Catalog Number	Shaft	Jaw	Length (in.)
EO080R	STR	SERR	10 1/4
EO075R	S-CVD	SMOOTH	9 3/4
EO082R	S-CVD	SERR	9 3/4
EO077R	S-CVD	W/ GROOVE	10



EO080R

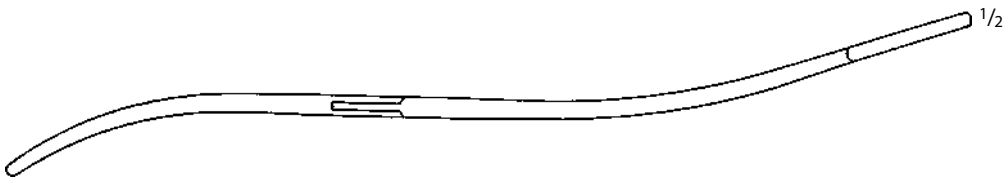

EO080R



EO075R, EO082R, EO077R

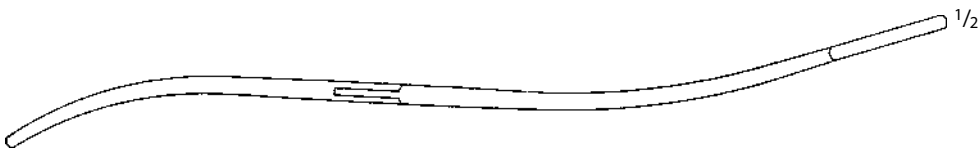

EO075R, EO082R, EO077R

BOZEMANN-DOUGLAS Forceps

Catalog Number	Tip	Length (in.)
EO085R	SERR	10 1/4



EO085R

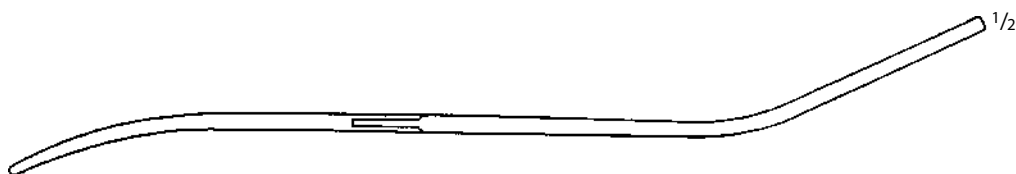

EO085R

ADAIR Uterine Forceps

Catalog Number	Teeth	Length (in.)
EO106R	1 x 1	7 1/2

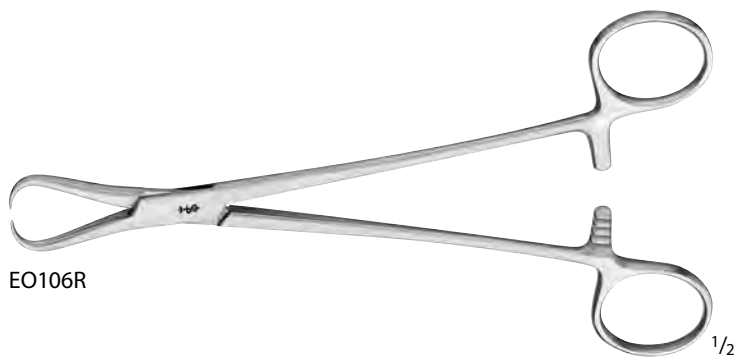

EO106R

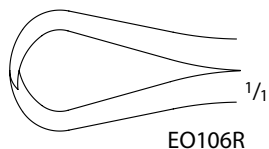

EO106R

POZZI Tenaculum Forceps,
 Standard

Catalog Number	Teeth	Length (in.)
EO105R	1 x 1	6 7/8



EO105R

1/2

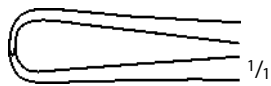

EO105R

1/1

BARRETT Uterine Tenaculum Forceps

Catalog Number	Teeth	Length (in.)
MG200R	1 x 1	7

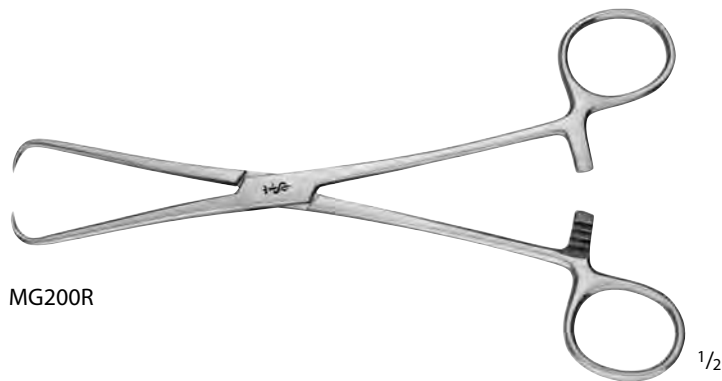

MG200R

1/2



MG200R

1/1

BRAUN Tenaculum Forceps

Catalog Number	Teeth	Length (in.)
EO108R	1 x 1	9 3/4



EO108R

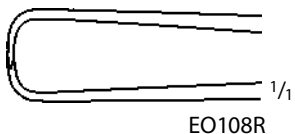

EO108R

SCHROEDER Tenaculum Forceps

Catalog Number	Shaft	Teeth	Length (in.)
EO110R	STR	1 x 1	9 3/4



EO110R

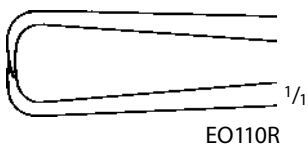

EO110R

SCHROEDER Tenaculum Forceps

Catalog Number	Shaft	Teeth	Length (in.)
EO150R	STR	2 x 2	9 3/4
EO151R	CVD	2 x 2	9 3/4
EO163R	STR	3 x 3	10 5/8



EO150R-EO151R



EO150R



EO151R



EO163R

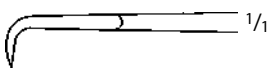

EO163R

POZZI Tenaculum Forceps, Heavy

Catalog Number	Teeth	Length (in.)
EO125R	1 x 1	10



EO125R

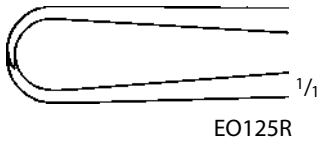

EO125R

DUPLAY Tenaculum Forceps, Delicate

Catalog Number	Teeth	Length (in.)
EO130R	1 x 1	9 3/4



EO130R

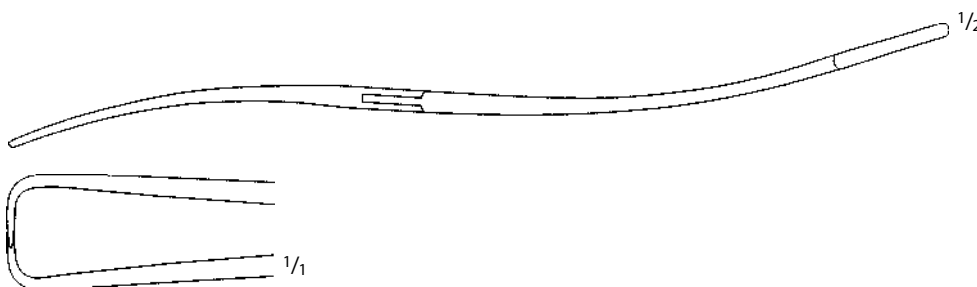

EO130R

ABEL Tenaculum Forceps

Catalog Number	Teeth	Length (in.)
EO140R	1 x 1	11



EO140R

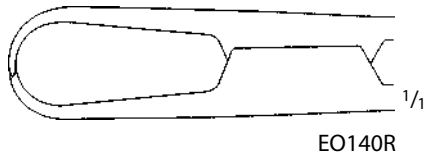

EO140R

HENROTIN Uterine Vulsellum Forceps

Catalog Number	Teeth	Length (in.)
MG202R	2 x 3	8 1/4

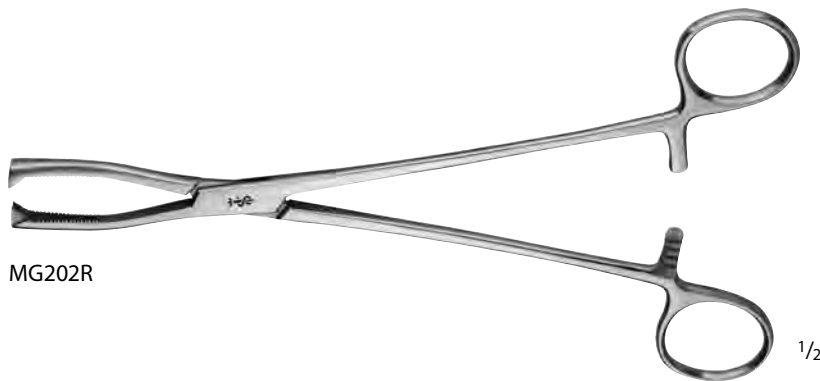

MG202R

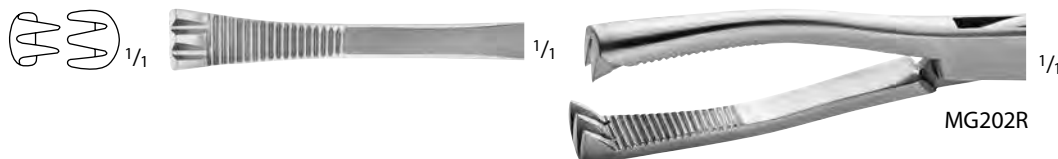

MG202R



MB272R

GORDON Uterine Vulsellum Forceps

Catalog Number	Teeth	Length (in.)
MB272R	3 x 3	8 3/4



MB272R



EO164R

CZERNY Uterine Tenaculum Forceps

Catalog Number	Teeth	Length (in.)
EO164R	4 x 4	7 7/8

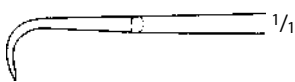

EO164R

Tenaculum Forceps

Catalog Number	Teeth	Length (in.)
EO165R	4 x 4	10 1/4



EO165R

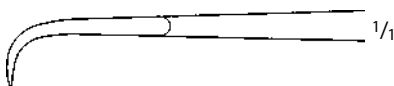

EO165R

PRATT Tenaculum Forceps

Catalog Number	Teeth	Length (in.)
EO166R	4 x 4	10 5/8



EO166R

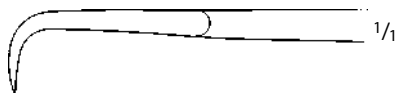

TEALE Tenaculum Forceps

Catalog Number	Teeth	Length (in.)
MG184R	3 x 4	9 5/8
EO180R	3 x 4	10

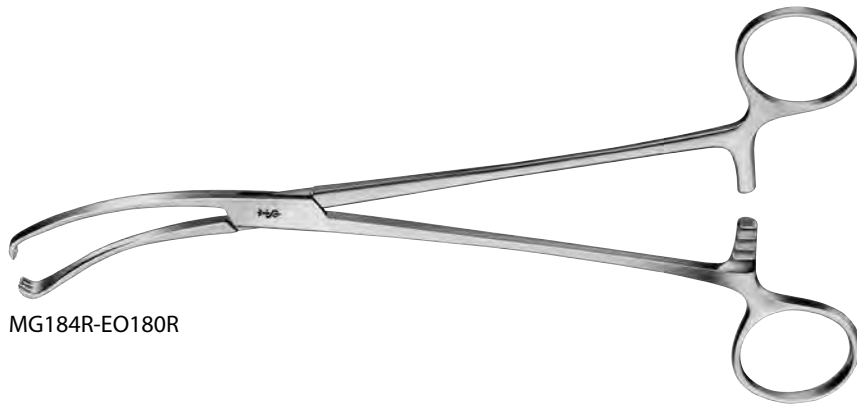

MG184R-EO180R

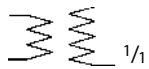

MG184R-EO180R



EO202R



EO202R

JACOBS Vulsellum Forceps

Catalog Number	Teeth	Length (in.)
EO202R	2 x 2	8 1/2

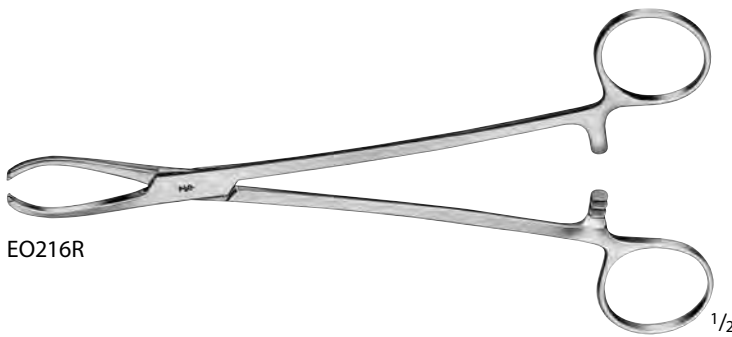

EO216R

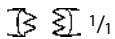

EO216R

LITTLEWOOD Tenaculum Forceps

Catalog Number	Teeth	Length (in.)
EO216R	2 x 3	7 1/4



EO218R



EO218R

MUSEUX Tenaculum Forceps, Small

Catalog Number	Teeth	Length (in.)
EO218R	2 x 2	7 7/8

MUSEUX Tenaculum Forceps

Catalog Number	Jaw	Length (in.)
EO220R	STR	9 1/2
EO221R	STR	9 1/2
EO222R	STR	9 1/2



EO220R-EO222R

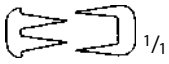

EO220R

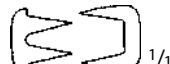

EO221R



EO222R

MUSEUX Tenaculum Forceps

Catalog Number	Jaw	Length (in.)
EO225R	CVD	9 1/2



EO225R

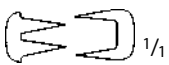

EO225R

MUSEUX Tenaculum Forceps

Catalog Number	Jaw	Size	Length (in.)
EO240R	STR	LARGE	10 1/2
EO242R	STR	X-LARGE	10 1/2



EO240R-EO242R

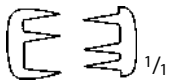

EO240R

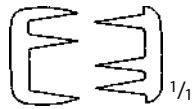

EO242R

FLETCHER-VAN DOREN Uterine Polyp,
 Sponge Holding Forceps

Catalog Number	Length (in.)
MB273R	9 1/2



MB273R



MB273R

Let Us know if you could not find what you are looking for

FLETCHER Sponge Forceps

Catalog Number	Tip	Length (in.)
MG193R	STR	9 3/4



MG193R



MG193R

OVERSTREET Endometrial Polyp Forceps

Catalog Number	Jaw	Length (in.)
MG195R	HOLLOW, FENESTRATED	9 1/4



MG195R



MG195R

HEYWOOD-SMITH Polyp Forceps

Catalog Number	Length (in.)
EO310R	9 3/4



NOTO Polyp Forceps

Catalog Number	Length (in.)
EO315R	11



DOYEN Ovum Forceps

Catalog Number	Length (in.)
EO332R	7 1/4



EO332R



EO332R

Atraumatic Ovum Forceps

Catalog Number	Tip	Length (in.)
EO338R	SMALL	9 3/4



EO338R

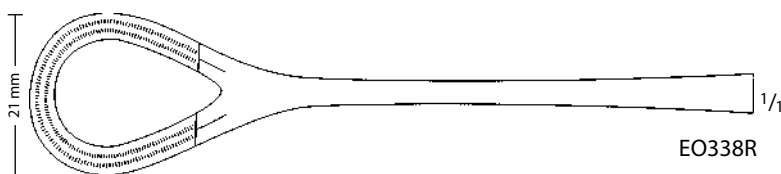

EO338R

DARTIGUES Elevating Forceps

Catalog Number	Length (in.)
EO407R	10



EO407R

SOMER Uterine Elevating Forceps

Catalog Number	Length (in.)
EO415R	9 1/4



EO415R

COLLIN Uterine Elevating Forceps

Catalog Number	Length (in.)
EO405R	11 1/4



EO405R

COLLIN Uterine Elevating Forceps,
 Movable Jaw

Catalog Number	Blade	Length (in.)
EO420R	STR	10 1/2

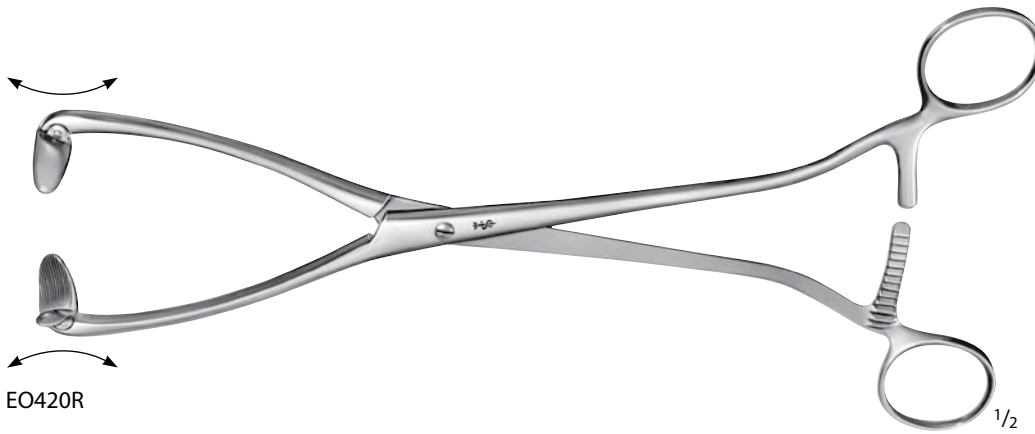

EO420R

HULKA-KENWICK Uterine Elevating Forceps

Catalog Number	Length (in.)
EO422R	10 3/4



EO422R



EO422R

IOWA Membrane Puncturing Forceps

Catalog Number	Length (in.)
MG189R	10



MG189R

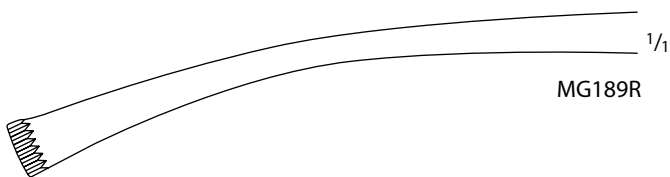

MG189R

DOYEN Myoma Screw

Catalog Number	Length (in.)
EO433R	6
EO435R	7 1/2

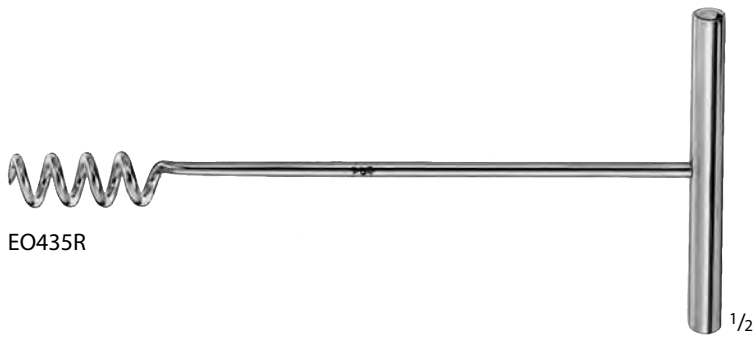

NAEGELE Obstetrical Forceps

Catalog Number	Length (in.)
ET205R	14

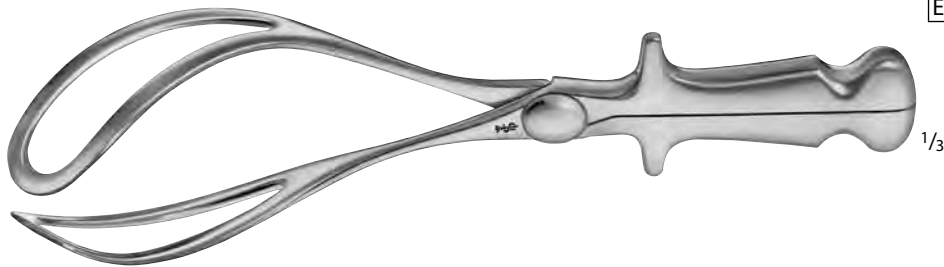

ET205R

KIELLAND Obstetrical Forceps

Catalog Number	Length (in.)
ET210R	16 1/2



ET210R

SIMPSON-BRAUN Obstetrical Forceps

Catalog Number	Length (in.)
ET220R	12
ET221R	13 3/4



ET220R



ET221R



DE LEE Obstetrical Forceps

Catalog Number	Length (in.)
MG190R	12
MG185R	14

MG190R-MG185R

ELLIOTT Obstetrical Forceps

Catalog Number	Length (in.)
MG191R	15



MG191R

PIPER Obstetrical Forceps, F/ Breach

Catalog Number	Length (in.)
ET237R	17 1/2

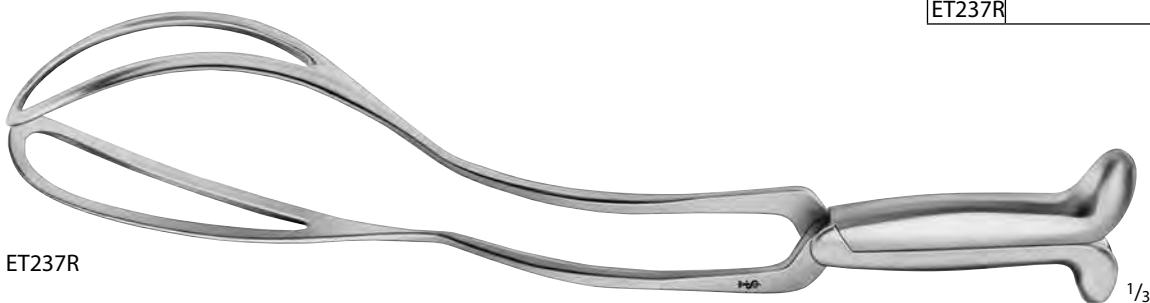

ET237R



ET245R

SIMPSON C-Section Forceps

Catalog Number	Length (in.)
ET245R	9 1/4



ET255R

BARNES-NEVILLE Obstetrical Forceps,
 With Traction Handle

Catalog Number	Length (in.)
ET255R	17 1/8



MG183R

BILL Traction Handle

Catalog Number	Description
MG183R	FOR USE W/ STANDARD OB FORCEPS

LUIKART-SIMPSON Obstetrical Forceps

Catalog Number	Length (in.)
MB298R	14



MB298R

LUIKART-MCLANE Obstetrical Forceps

Catalog Number	Length (in.)
MB299R	15 1/2



MB299R

LUIKART-KIELLAND Obstetrical Forceps

Catalog Number	Length (in.)
MB069R	15 1/2



MB069R

LUIKHART Obstetrical Forceps

Catalog Number	Length (in.)
MG186R	16



MG186R

MCLANE-TUCKER Obstetrical Forceps

Catalog Number	Length (in.)
MG192R	16 1/4



MG192R

MURLESS Head Extractor

Catalog Number	Length (in.)
MG492R	10



MG492R

SELLHEIM Obstetric Lever

Catalog Number	Blade	Length (in.)
ET270R	OPEN	11 3/4



ET270R

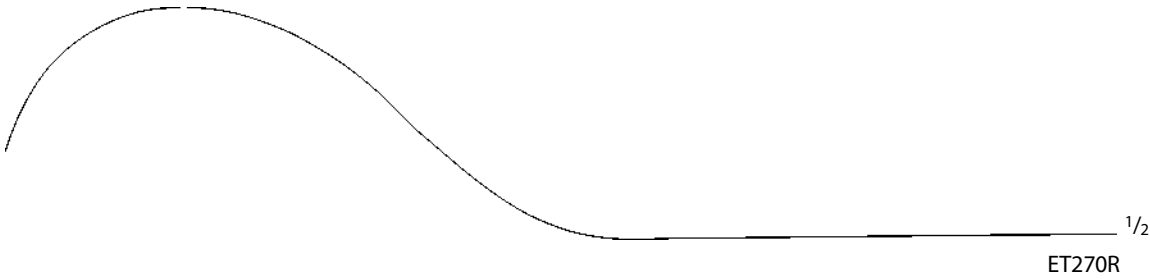

ET270R

GREEN-ARMYTAGE Forceps,
 F/ C-Section

Catalog Number	Length (in.)
ET269R	8 3/4



ET269R



ET269R

BARRETT Placenta Forceps

Catalog Number	Blade	Length (in.)
MG201R	FENESTRATED	10

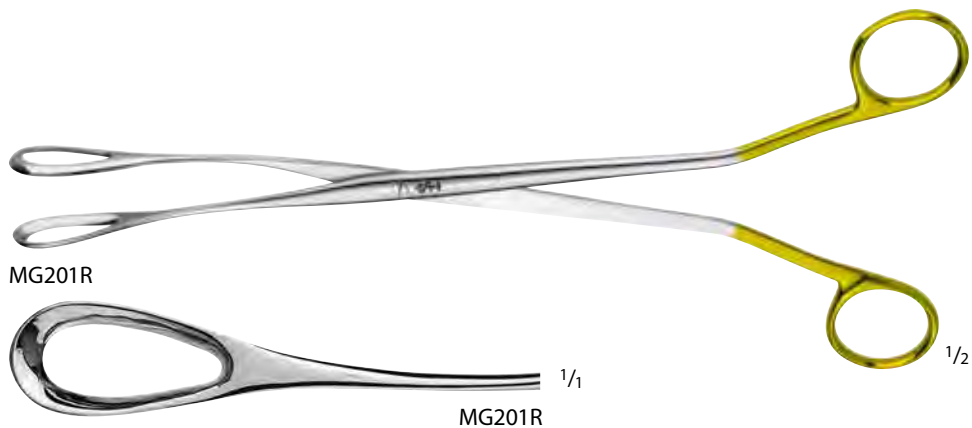

BIERER Ovum Forceps

Catalog Number	Jaw (mm)	Ratchet	Length (in.)
MG466R	16	NO	11
MG467R	16	YES	11
MG468R	19	NO	11
MG469R	19	YES	11

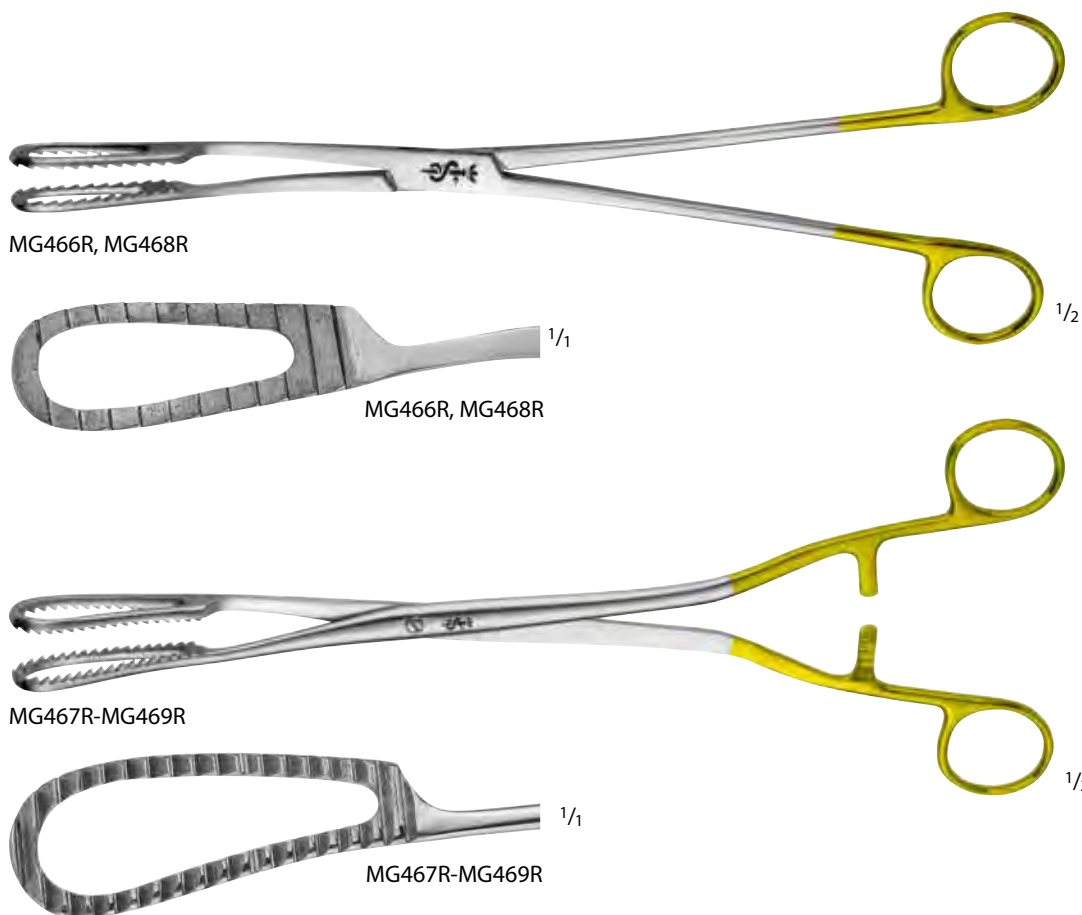

WINTER Placenta and Ovum Forceps,
 W/O Ratchet

Catalog Number	Size (#)	Jaw	Length (in.)
ET301R	1	STR	11 1/2
ET302R	2	STR	11 1/2



ET301R-ET302R



1/1
 #1
 ET301R



1/1
 #2
 ET302R

WINTER Placenta and Ovum Forceps,
 W/O Ratchet (continued)

Catalog Number	Size (#)	Jaw	Length (in.)
ET306R	1	CVD	11 1/2
ET307R	2	CVD	11 1/2
ET308R	3	CVD	11 1/2



ET306R-ET308R



ET306R



ET307R



ET308R

WINTER Placenta and Ovum Forceps,
 W/ Ratchet

Catalog Number	Size (#)	Jaw	Length (in.)
ET315R	2	CVD	11 1/2
ET316R	3	CVD	11 1/2

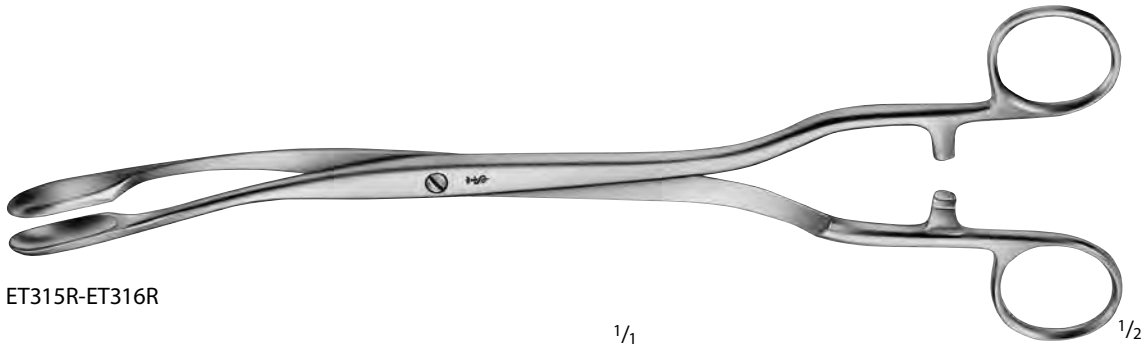

ET315R-ET316R

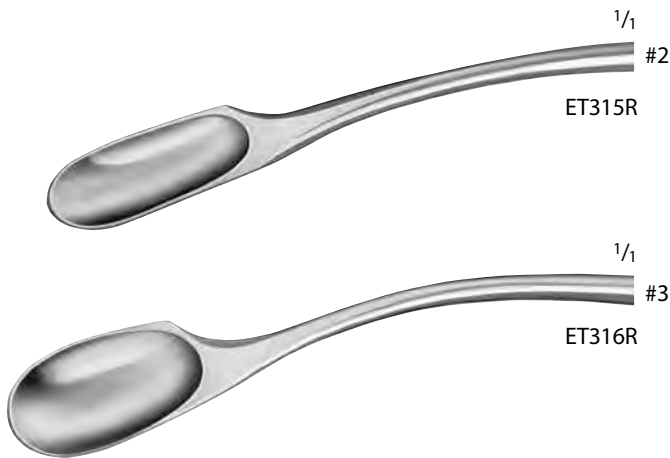

SAENGER Placenta and Ovum Forceps,
 W/ Ratchet

Catalog Number	Jaw	Length (in.)
ET326R	STR	10 3/4
ET327R	CVD	10 1/2
ET325R	CVD	11 1/4

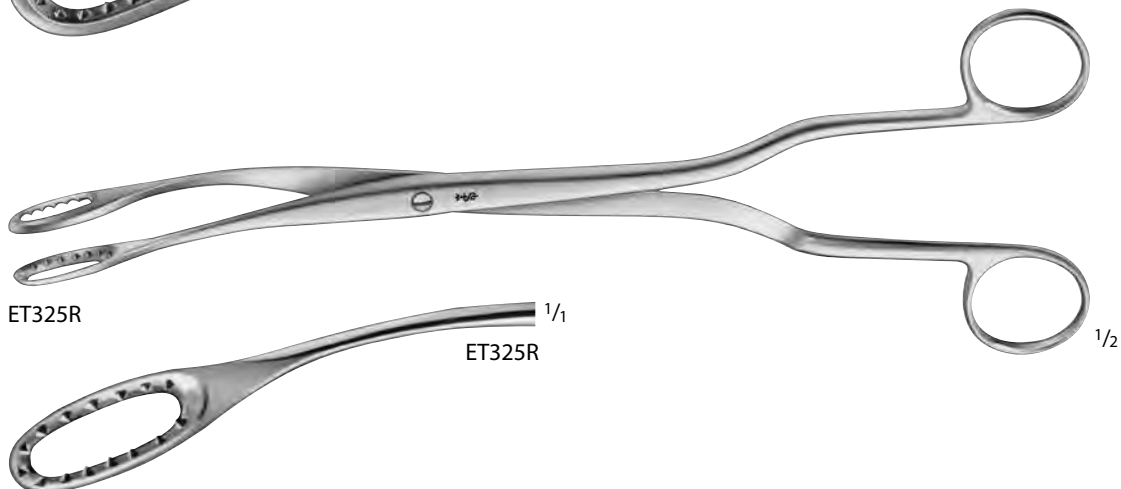
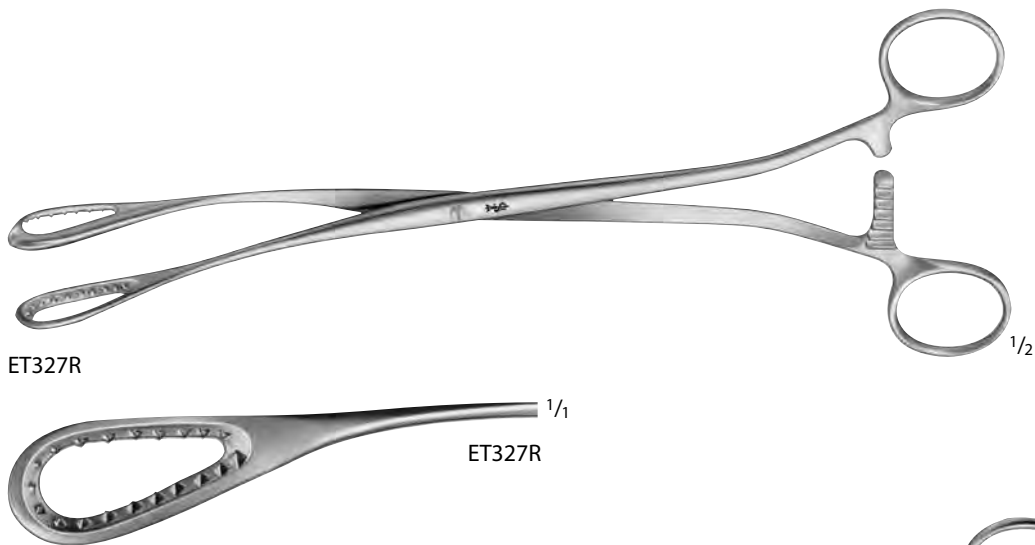
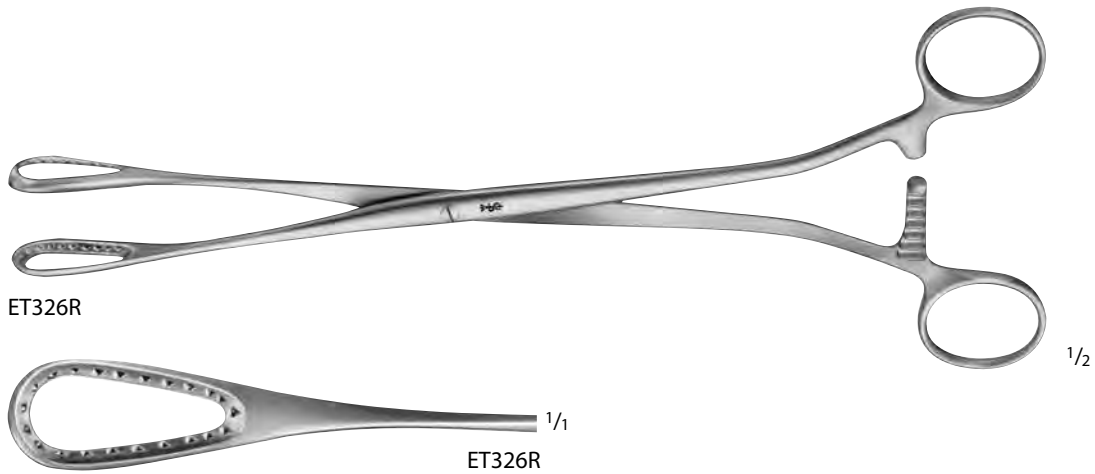

MCCLINTOCK Placenta and Ovum
 Forceps

Catalog Number	Length (in.)
ET329R	9 1/2



ET329R



ET329R 1/1

THOMS-GAYLOR Biopsy Forceps,
 S-Shape

Catalog Number	Length (in.)
ER050R	9 1/2

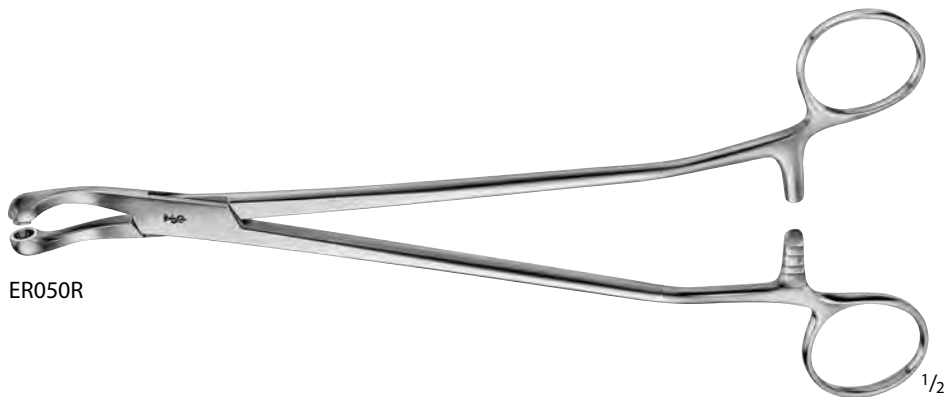

ER050R



ER050R

SCHUMACHER Biopsy Forceps, S-Shape

Catalog Number	Tip	Length (in.)
ER061R	SMALL	9 1/2
ER062R	LARGE	9 1/2

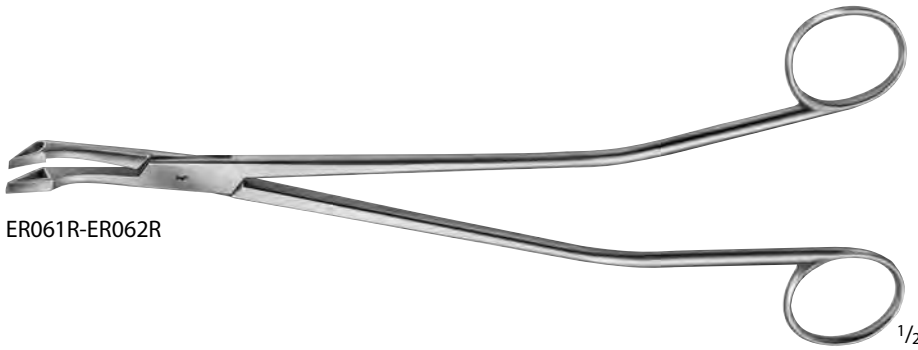

ER061R-ER062R



ER061R



ER062R

SCHUMACHER Biopsy Rongeur

Catalog Number	Tip	Length (in.)
ER063R	SMALL	9 1/2
ER064R	LARGE	9 1/2

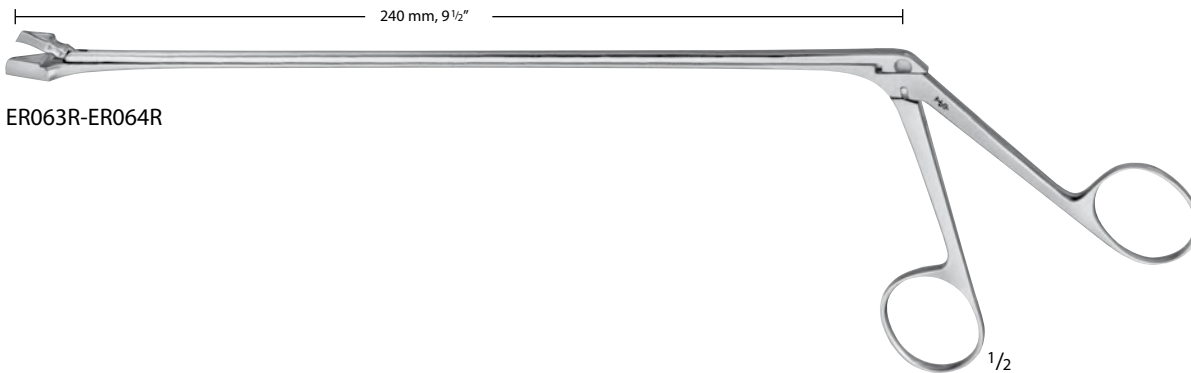

ER063R-ER064R



ER063R



ER064R

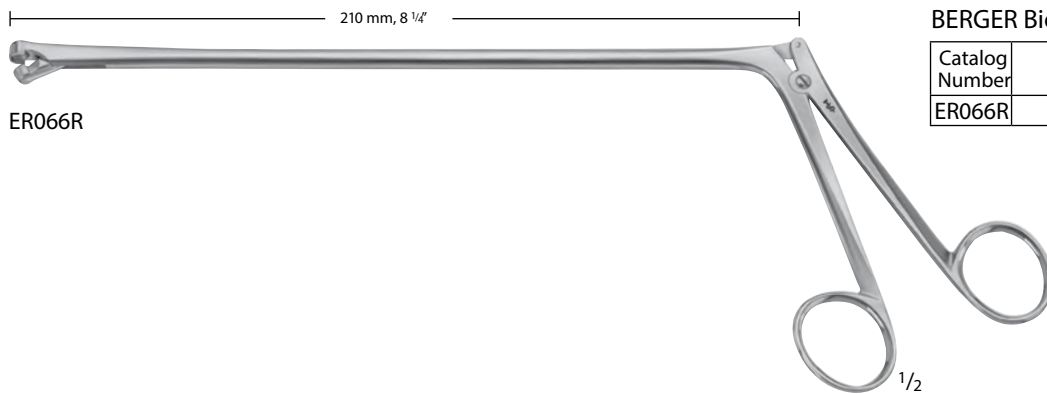

ER066R

BERGER Biopsy Forceps

Catalog Number	Length (in.)
ER066R	8 1/4



ER066R



ER068R-MG187R

TISCHLER Cervical Biopsy Punch Forceps

Catalog Number	Jaw Size (mm)	Working Length (in.)
ER068R	5 x 6 x 3	8 1/4
MG187R	7 x 3	11



ER068R



TISCHLER Biopsy Alligator Forceps

Catalog Number	Jaw	Jaw Size (mm)	Length (in.)
MG076R	OBLONG CUP SINGLE TOOTH	7 x 3	9 3/4



KEVORKIAN-YOUNGE Biopsy Forceps

Catalog Number	Jaw Size (mm)	Working Length (in.)
ER080R	8.5 x 3.5	10

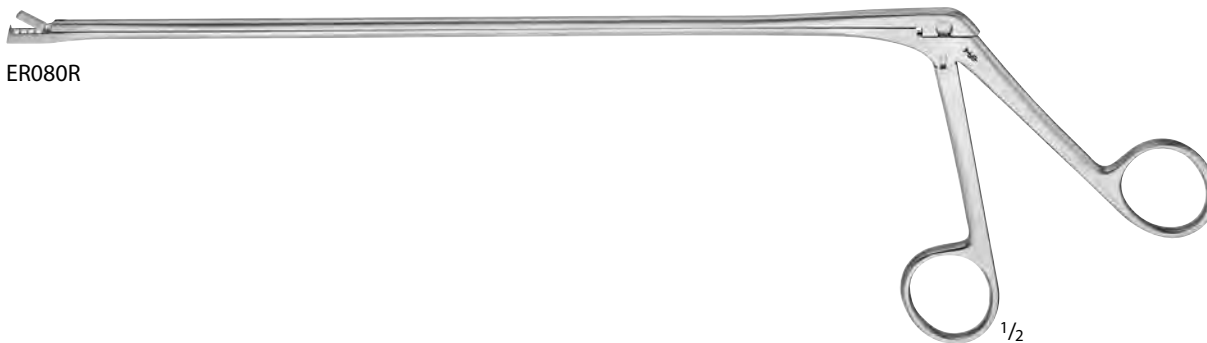

WITTNER Biopsy Forceps

Catalog Number	Jaw	Jaw Size (mm)	Working Length (in.)
MG194R	STR. JAWS W/ TEETH	4 x 8	9



EPPENDORF Biopsy Forceps

Catalog Number	Jaw Size (mm)	Working Length (in.)
ER070R	8 x 4	8

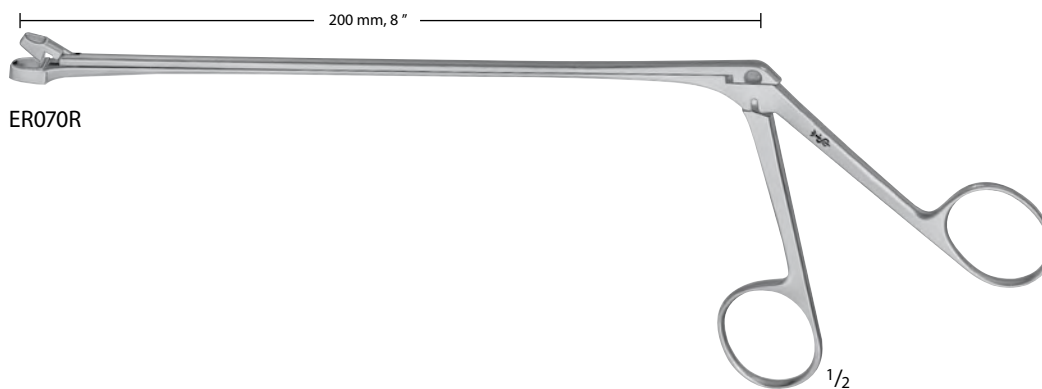

PHANEUF Hysterectomy Forceps

Catalog Number	Jaw	Length (in.)
BJ500R	STR	8 1/4
BJ501R	ANG	8

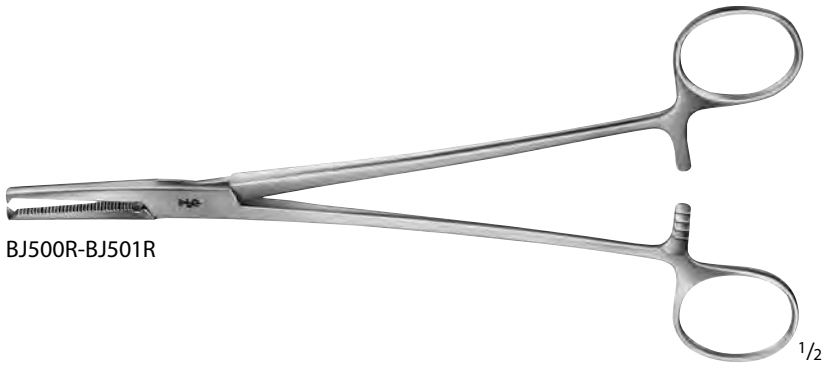

BJ500R-BJ501R



BJ500R



BJ501R

HOLZBACH Hysterectomy Forceps

Catalog Number	Jaw	Length (in.)
BJ510R	STR	9 5/8
BJ511R	CVD	9 5/8

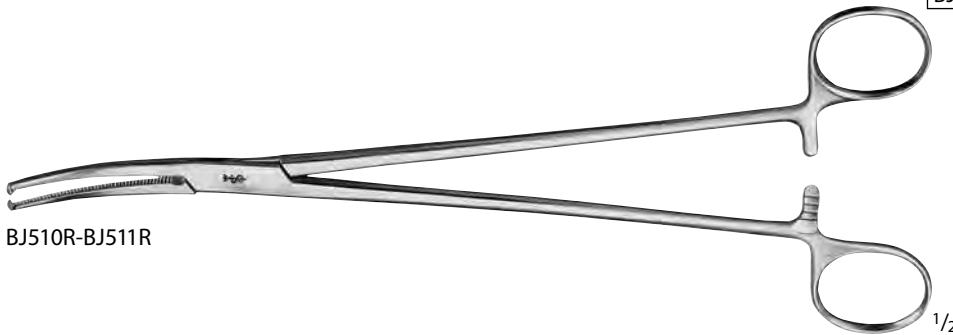

BJ510R-BJ511R



BJ510R



BJ511R

HEANEY-REZEK Hysterectomy Forceps

Catalog Number	Jaw	Length (in.)
BJ524R	STR	8 1/4



BJ524R



BJ524R

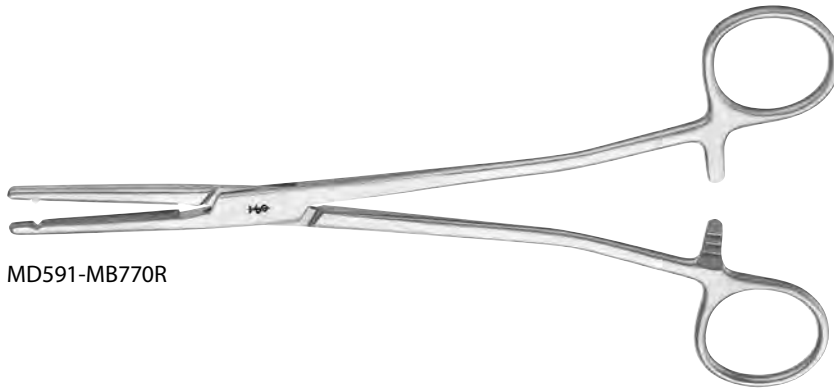

MD591-MB770R



MD591



MD592

HEANEY-BALLENTINE Hysterectomy
 Forceps, Longitudinal Grooves

Catalog Number	Jaw	Length (in.)
MD591	STR	8 1/2
MB757R	STR	10 1/2
MB754R	STR	12
MB771R	STR	14
MD592	CVD	8 1/2
MB749R	CVD	10 1/2
MB753R	CVD	12
MB770R	CVD	14

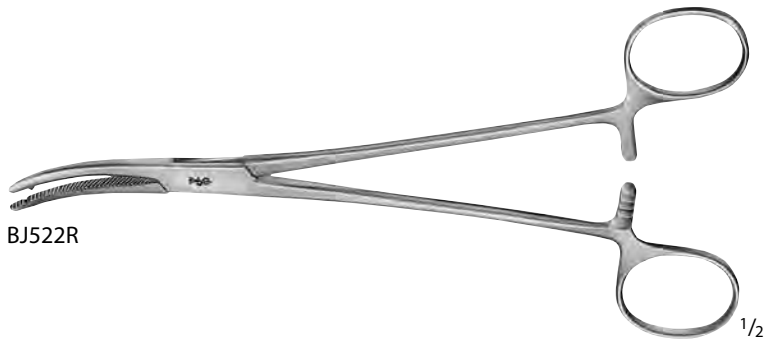

BJ522R

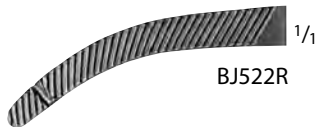

BJ522R

HEANEY Hysterectomy Forceps

Catalog Number	Jaw	Teeth	Length (in.)
BJ522R	CVD	1	7 3/4
BJ520R	CVD	2	8
BJ521R	CVD	2	9 3/4



BJ520R-BJ521R



BJ520R

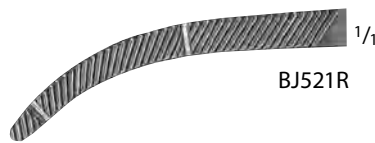

BJ521R

HEANEY Hysterectomy Forceps
 (continued)

Catalog Number	Jaw	Teeth	Length (in.)
MB906R	STR	2	12
MB907R	CVD	2	12

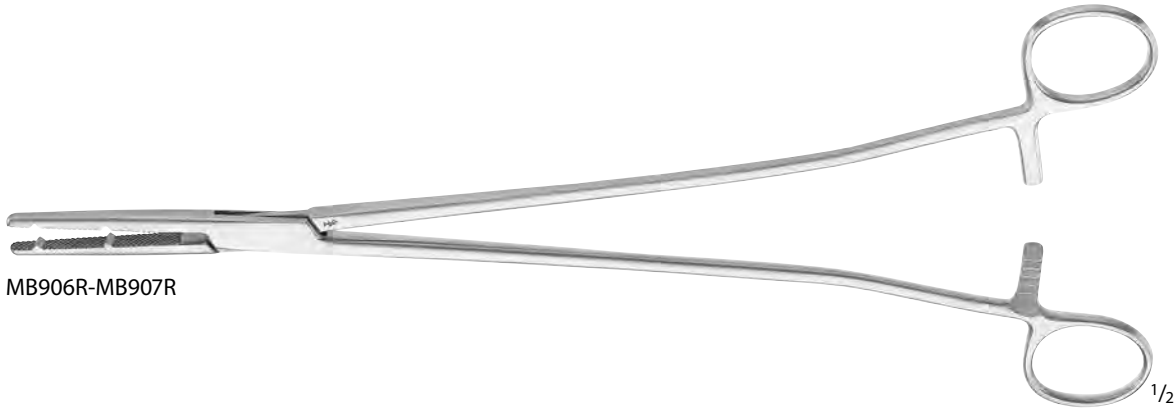

MB906R-MB907R



MB906R



MB907R

HEANEY Hysterectomy Forceps, Heavy

Catalog Number	Jaw	Length (in.)
MB797R	CVD	8 1/4



MB797R

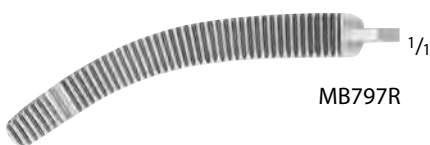

MB797R

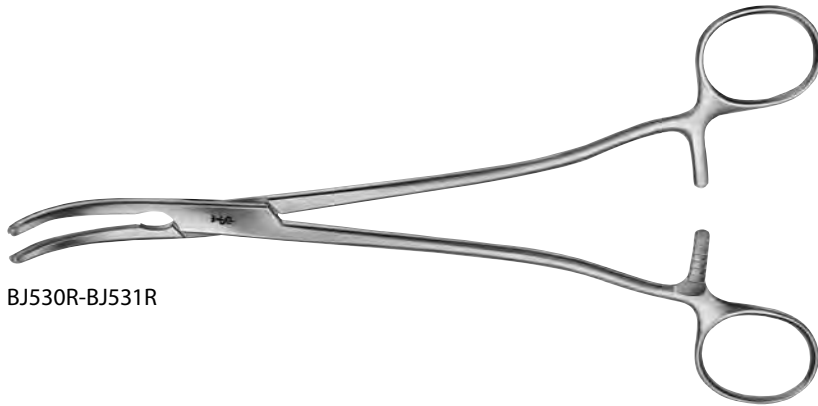

BJ530R-BJ531R

HEANEY Hysterectomy Forceps,
 W/O Teeth

Catalog Number	Jaw	Length (in.)
BJ530R	STR	8 7/8
BJ532R	CVD	8 1/2
BJ531R	CVD	8 3/4

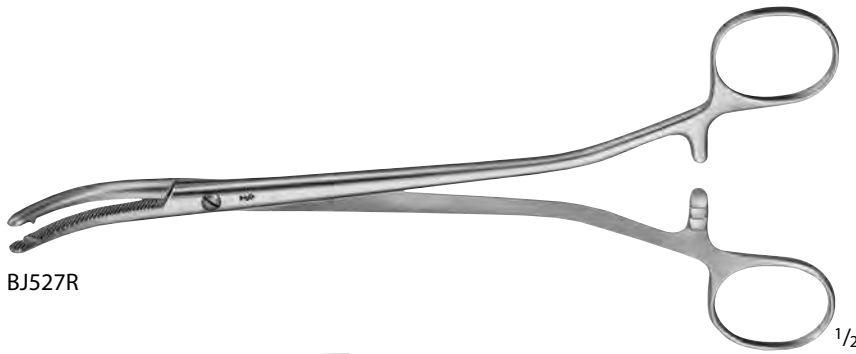
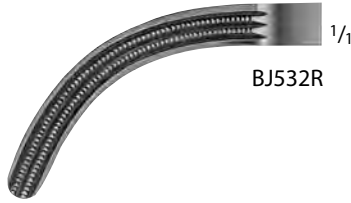

BJ527R

WIENER Hysterectomy Forceps,
 W/ Grooves

Catalog Number	Tip	Jaw	Length (in.)
BJ527R	SMOOTH	CVD	9 1/2



WERTHEIM Atraumatic Parametrium
 Clamp

Catalog Number	Jaw	Length (in.)
BJ550R	STR	9 3/4
BJ551R	SLT-CVD	9 5/8
BJ552R	CVD	9 1/2
BJ553R	UP-CVD	8 3/4

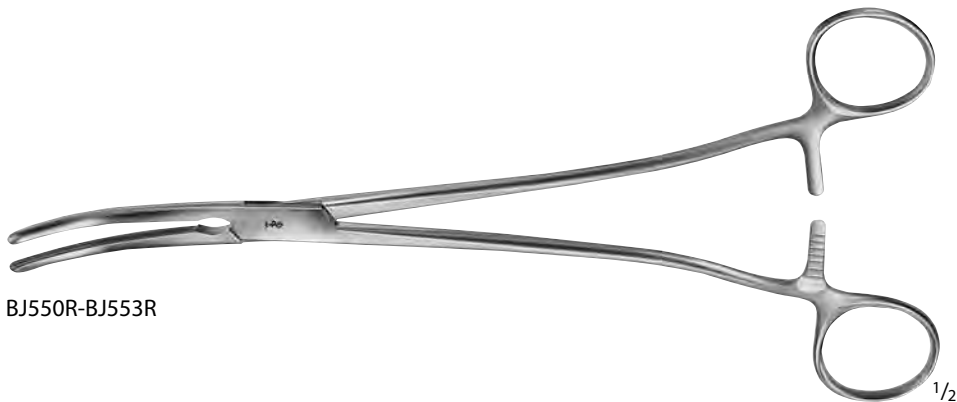

BJ550R-BJ553R



BJ550R



BJ551R



BJ552R



BJ553R

WERTHEIM Parametrium Clamp

Catalog Number	Jaw	Length (in.)
BJ576R	CVD	10 1/4



BJ576R

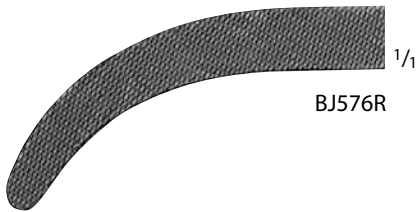

BJ576R

WERTHEIM Hysterectomy Forceps

Catalog Number	Jaw	Length (in.)
BJ574R	CVD	10

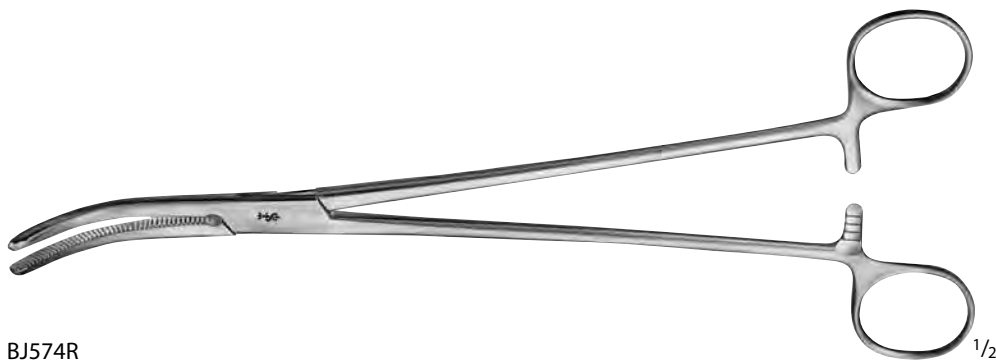

BJ574R

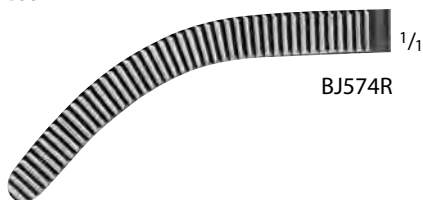

BJ574R

WERTHEIM-CULLEN Clamp

Catalog Number	Jaw	Length (in.)
BJ579R	RIGHT-ANG	8 1/2



BJ579R

1/2

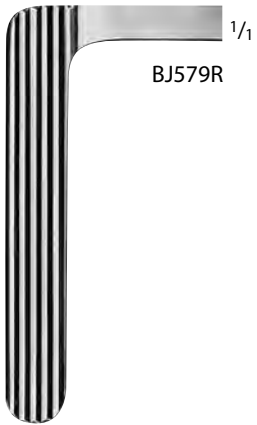

BJ579R

1/1

WERTHEIM Atraumatic Clamp

Catalog Number	Jaw	Length (in.)
BJ581R	RIGHT-ANG	9 3/4



BJ581R

1/2

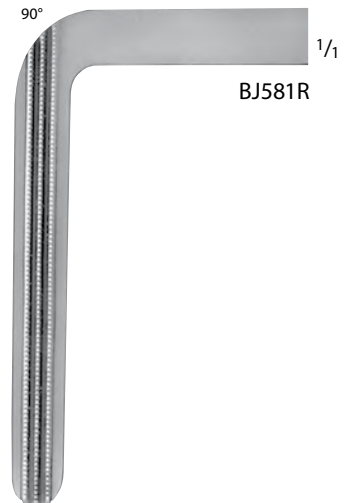

BJ581R

90°

1/1

GLASSMAN Anterior Resection Clamp

Catalog Number	Jaw	Jaw Length (mm)	Length (in.)
MB931R	90°, SERR	25	9 3/4
MB130R	90°, SERR	50	9 3/4
MB932R	90°, SERR	75	10



MB130R-MB932R



MB931R

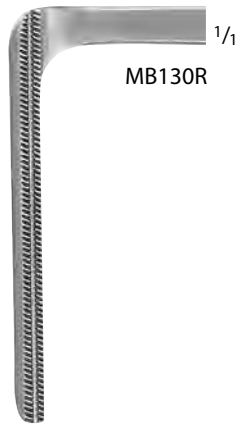

MB130R

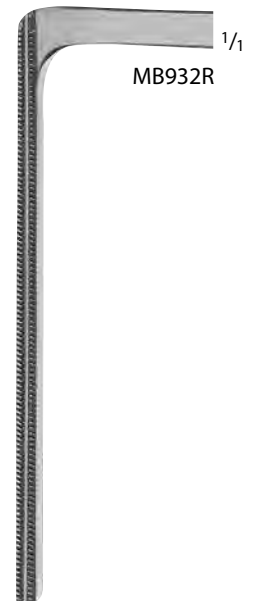

MB932R

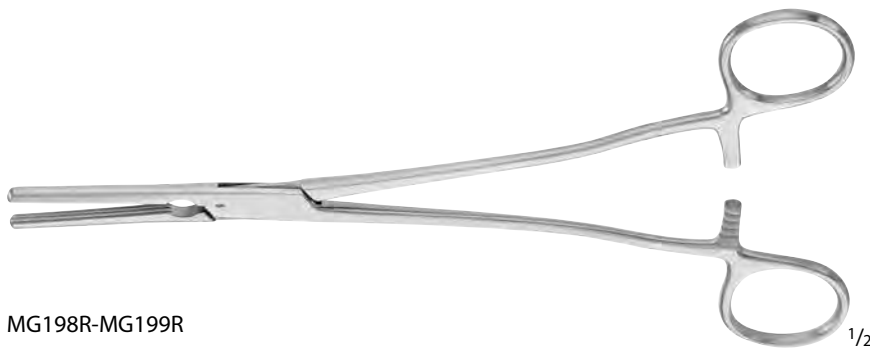

MG198R-MG199R



MG198R



MG199R

MASTERSON Uterine Clamp

Catalog Number	Jaw	Length (in.)
MG198R	STR	8 1/2
MG199R	CVD	8 1/2

Let Us know if you could not find what you are looking for



MG203R-MB206R, MB352R-MB355R, MB183R-MB188R

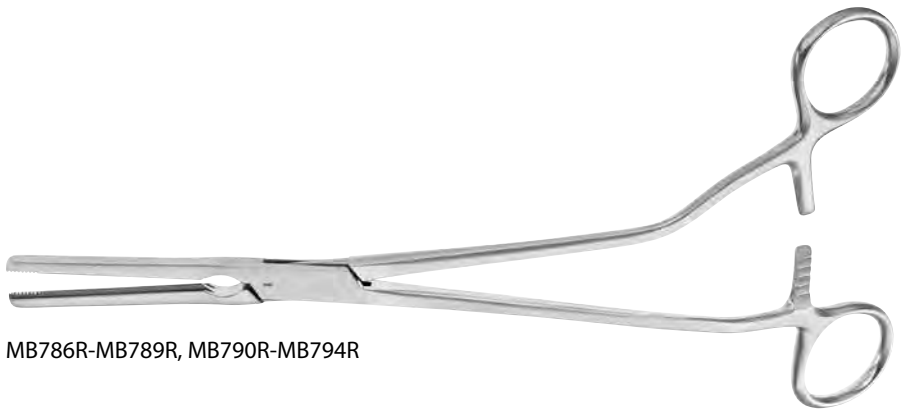

MB786R-MB789R, MB790R-MB794R



MG203R, MB352R, MB786R, MB187R, MB790R



MG204R, MB353R, MB787R, MB188R, MB792R



MG205R, MB354R, MB788R, MB183R, MB793R



MG206R, MB355R, MB789R, MB184R, MB794R

Z-Type Hysterectomy Clamp

Catalog Number	Jaw	Handle	Length (in.)
MG203R	STR	STR	8 1/2
MG204R	SLIGHT-CVD	STR	8 1/2
MG205R	CVD	STR	8 1/2
MG206R	ANG	STR	8 1/2
MB352R	STR	STR	9 1/2
MB353R	SLIGHT-CVD	STR	9 1/2
MB354R	CVD	STR	9 1/2
MB355R	ANG	STR	9 1/2
MB786R	STR	ANG	9 1/2
MB787R	SLIGHT-CVD	ANG	9 1/2
MB788R	CVD	ANG	9 1/2
MB789R	ANG	ANG	9 1/2
MB187R	STR	STR	12
MB188R	SLIGHT-CVD	STR	12
MB183R	CVD	STR	12
MB184R	ANG	STR	12
MB790R	STR	ANG	12
MB792R	SLIGHT-CVD	ANG	12
MB793R	CVD	ANG	12
MB794R	ANG	ANG	12

Z-Type Hysterectomy Clamp
 (continued)

Catalog Number	Jaw	Handle	Length (in.)
MB185R	STR	STR	14
MB186R	SLT-CVD	STR	14
MB987R	CVD	STR	14
MB988R	ANG	STR	14

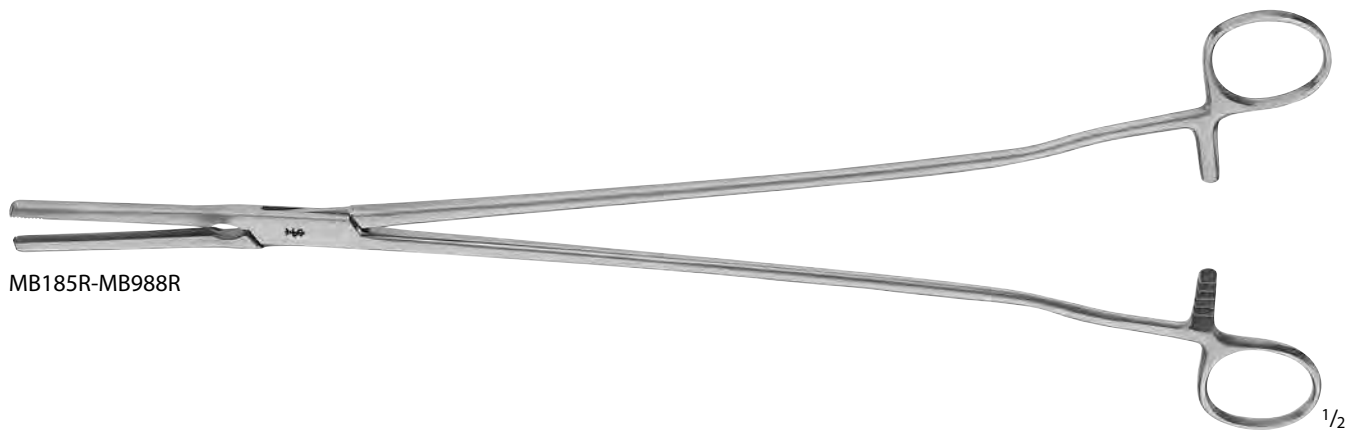

MB185R



MB186R



MB987R

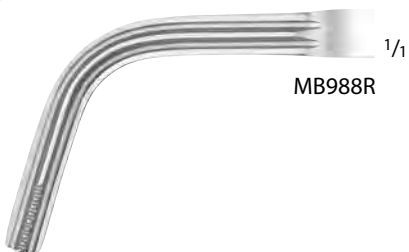

MB988R



MB199R



MB199R ^{1/1}

GELPI Perineal Retractor W/ Ball Stop

Catalog Number	Length (in.)
MB199R	7



MG176R, MG177R,
 BV996R, MD651



MG176R ^{1/1}

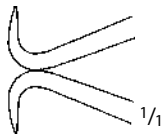

BV996R ^{1/1}

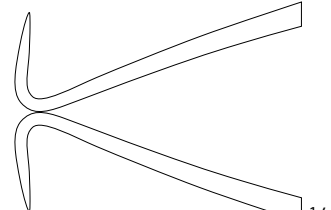

MD651 ^{1/1}

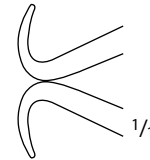

MG177R ^{1/1}

GELPI Vaginal Retractor

Catalog Number	Tip	Length (in.)
MG176R	SHARP	3 1/2
BV996R	SHARP	5 1/4
BV997R	SHARP	6 7/8
MD651	SHARP	7 1/4
MG177R	BLUNT	4 1/2



BV997R

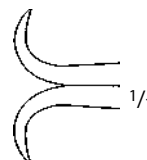

BV997R ^{1/1}



MB267R

RIGBY Vaginal Retractor

Catalog Number	Length (in.)
MB267R	7 1/2



MB068R

DELEE Universal Retractor

Catalog Number	Length (in.)
MB068R	9 1/2



US100-US100202

O' SULLIVAN-O' CONNOR Retractor

Catalog Number	Description	Blade Size (mm)
US100	COMPLETE	185 x 143
US100201	SMALL BLADE	80 x 149
US100202	LARGE BLADE	155 x 110

US100 Includes:
 1 Retractor US100200
 2 Blades US100201 and
 1 Blade US100202



US100201



US100202



EL011R

COLLIN Vaginal Specula

Catalog Number	Blade Size (mm)
EL011R	95/85 x 18



EL040R

CUSCO Vaginal Specula

Catalog Number	Blade Size (mm)
EL040R	75 x 17

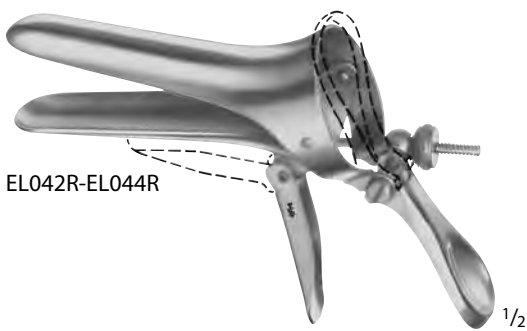

EL042R-EL044R

CUSCO Vaginal Specula

Catalog Number	Blade Size (mm)
EL042R	80 x 32
EL043R	90 x 36
EL044R	110 x 37



EL180R-EL181R

SEYFFERT Vaginal Specula

Catalog Number	Blade Size (mm)	Length (in.)
EL180R	100 x 17	9
EL181R	110 x 33	9

1/2

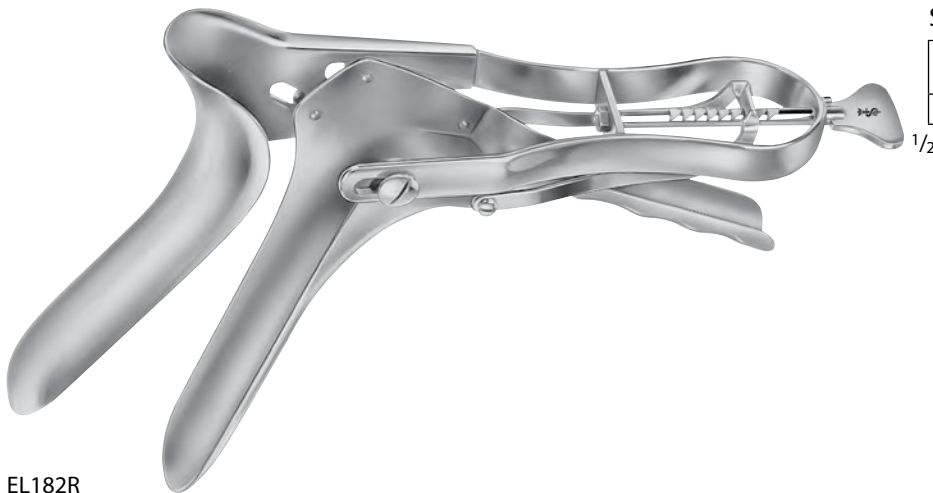

EL182R

SEYFFERT Speculum, 1 Side Open

Catalog Number	Blade Size (mm)	Length (in.)
EL182R	110 x 33	9

1/2



EL183R

SEMM Vaginal Specula, 45° Angle

Catalog Number	Blade Size (mm)	Length (in.)
EL183R	90 x 14	7

1/2



MB066R-EL193R

PEDERSON Vaginal Speculum

Catalog Number	Blade Size (mm)
MB066R	75 x 12.7
EL192R	100 x 22
MG156R	115 x 16
EL193R	120 x 25



MB067R

PEDERSON Vaginal Speculum, Large,
 Insulated Coating, W/ Evacuation Vent

Catalog Number	Blade Size (mm)
MB067R	120 x 25



EL194R-MG159R

GRAVES Vaginal Speculum

Catalog Number	Blade Size (mm)
EL194R	75 x 20
EL195R	95 x 30
EL196R	105 x 33
MG159R	125 x 40
MB841R	102 x 34 W/ SIDE OPENING



MB841R



EL420R-EL428R

KRISTELLER Vaginal Speculum, Set of 2 each

Catalog Number	Blade Size (mm)	Length (in.)
EL420R	70 x 15	6 3/4
EL421R	70 x 27	6 7/8
EL422R	75 x 30	6 7/8
EL423R	90 x 36	6 7/8
EL426R	110 x 20	8 3/4
EL425R	110 x 27	8 3/4
EL427R	110 x 30	8 3/4
EL428R	110 x 36	8 3/4

Each blade size comes as a set of 2 - with one upper and one lower blade



EL450R-EL458R

KRISTELLER Vaginal Specula Upper
 Blades

Catalog Number	Blade Size (mm)	Length (in.)
EL450R	75 x 10	6 7/8
EL451R	75 x 23	7
EL452R	80 x 25	7
EL453R	100 x 32	7 1/4
EL454R	115 x 14	8 1/2
EL455R	115 x 23	8 1/2
EL457R	115 x 26	8 3/4
EL458R	120 x 30	8 7/8



EL450R



EL451R



EL452R



EL453R



EL454R



EL455R



EL457R



EL458R

Let Us know if you could not find what you are looking for



EL440R-EL448R

KRISTELLER Vaginal Specula Lower
 Blades

Catalog Number	Blade Size (mm)	Length (in.)
EL440R	70 x 15	6 7/8
EL441R	70 x 27	7
EL442R	75 x 30	7
EL443R	90 x 36	7 1/4
EL444R	110 x 18	8 1/2
EL445R	110 x 27	8 1/2
EL446R	110 x 20	8 3/4
EL447R	110 x 30	8 3/4
EL448R	110 x 36	8 7/8



EL440R



EL441R



EL442R



EL443R



EL444R



EL445R



EL446R

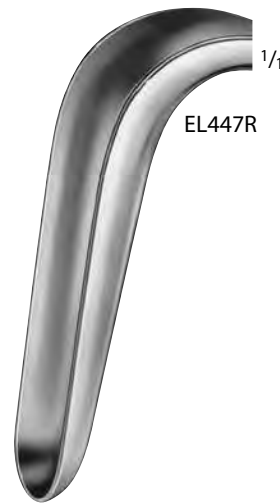

EL447R



EL448R

Let Us know if you could not find what you are looking for

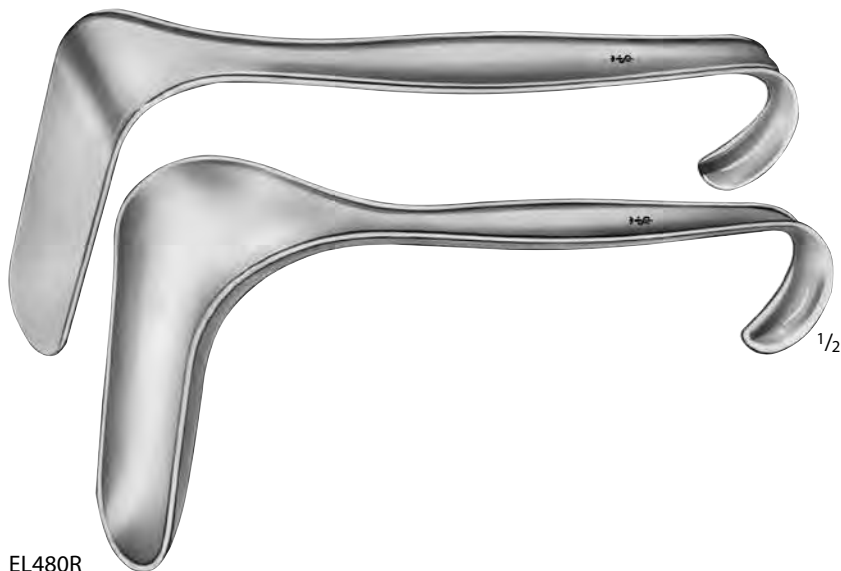

EL480R

KALLMORGEN Vaginal Specula Set of 2

Catalog Number	Blade Size (mm)	Length (in.)
EL480R	75 x 39	6 3/4



EL481R

KALLMORGEN Vaginal Specula Set of 2

Catalog Number	Blade Size (mm)	Length (in.)
EL481R	95 x 39	7 7/8



MB759R-MB761R

SIMS Vaginal Retractor

Catalog Number	Blade Size (mm)
MB759R	70 x 25
MB760R	76 x 32
MB761R	89 x 38



MG158R-EL409R

SIMS Vaginal Speculum, Double Ended

Catalog Number	Blade Size (mm)	Length (in.)
MG158R	69 x 25 / 70 x 30	5
EL407R	70 x 26 / 75 x 30	5
EL408R	75 x 30 / 80 x 35	6
EL409R	80 x 36 / 90 x 40	6 7/8



EL578R-EL579R



EL578R



EL579R

JACKSON Vaginal Speculum Lower
 Blade

Catalog Number	Blade	Blade Size (mm)	Length (in.)
EL578R	SLIGHT-CONCAVE	89 x 38	6 7/8
EL579R	SLIGHT-CONCAVE	102 x 38	6 7/8



EL581R, MB764R-MB765R

EASTMAN Vaginal Retractor

Catalog Number	Blade Size (mm)	Length (in.)
MB764R	75 x 40	6 7/8
EL581R	89 x 38	6 7/8
MB765R	100 x 40	6 7/8

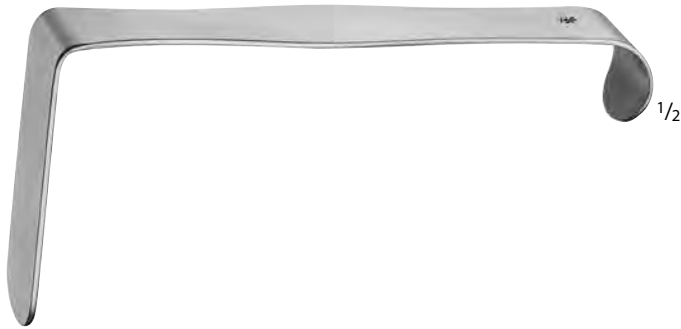

EL865R



MB762R-MB763R

HEANEY Retractor

Catalog Number	Blade Size (mm)	Length (in.)
MB762R	45 x 25	6 3/4
MB763R	73 x 29	6 3/4
EL865R	83 x 29	6 3/4



EL627R-EL629R

DOYEN Vaginal Speculum

Catalog Number	Blade Size (mm)	Length (in.)
EL627R	60 x 45	9 1/4
EL628R	90 x 45	9 1/4
EL629R	112 x 45	9 1/4

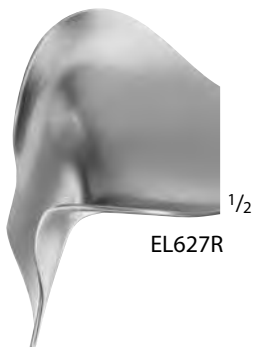

EL627R



EL628R

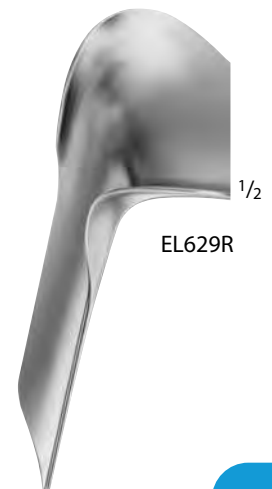

EL629R

DOYEN Vaginal Speculum

Catalog Number	Blade Size (mm)	Length (in.)
EL631R	60 x 35	9 1/2
EL632R	90 x 35	9 1/2
EL633R	120 x 35	9 1/2
EL634R	60 x 45	9 1/2
EL635R	90 x 45	9 1/2
EL636R	120 x 45	9 1/2
EL637R	60 x 60	9 1/2
EL638R	90 x 60	9 1/2
EL639R	120 x 60	9 1/2
EL642R	160 x 45	9 1/2
EL644R	160 x 60	9 1/2



EL631R-EL644R

BREISKY Vaginal Speculum

Catalog Number	Blade Size (mm)	Length (in.)
EL703R	100 x 20	11 3/4
EL704R	100 x 25	11 3/4
EL705R	100 x 30	11 3/4
EL707R	100 x 35	11 3/4
EL708R	100 x 40	11 3/4
EL693R	130 x 20	12 1/2
EL694R	130 x 25	12 1/2
EL695R	130 x 30	12 1/2
EL697R	130 x 35	12 1/2
EL698R	130 x 40	12 1/2
EL700R	160 x 40	13 3/4
EL702R	180 x 40	13 3/4



EL700R-EL708R, EL693R-EL698R

Let Us know if you could not find what you are looking for



EL736R

AUVARD Speculum, W/ Detachable Weight

Catalog Number	Blade Size (mm)	Length (in.)
EL736R	65 x 38-28	9

Weight:
 Speculum, only: 0.3 lbs.
 Weight, only: 1.7 lbs.

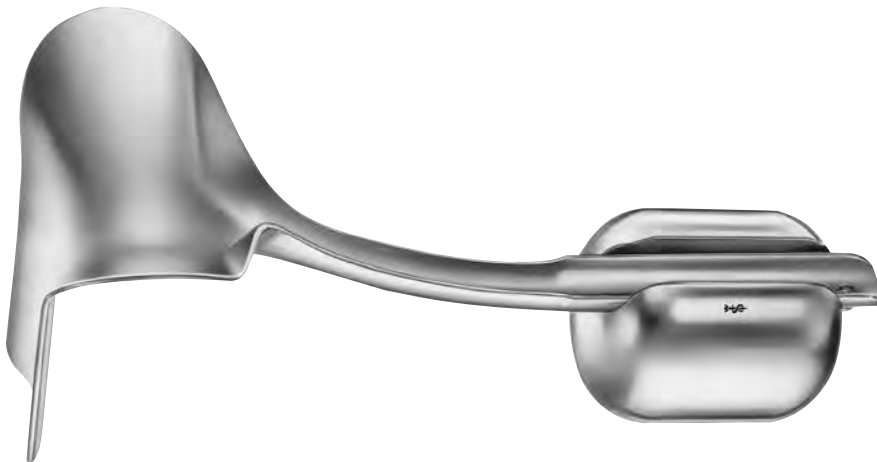

EL738R-EL739R

AUVARD Speculum, W/ Detachable Weight

Catalog Number	Blade Size (mm)	Length (in.)
EL738R	75 x 42-40	9
EL739R	105 x 43-40	9

AUVARD Speculum

Catalog Number	Blade Size (mm)	Length (in.)
MG157R	48 x 70	9 1/2
MD410	85 x 38	9 3/4
MD411	102 x 38	9 3/4



MG157R-MD411

STEINER-AUVARD Vaginal Speculum,
 Malleable, Goose Neck

Catalog Number	Blade Size (mm)
MB935R	140 x 30

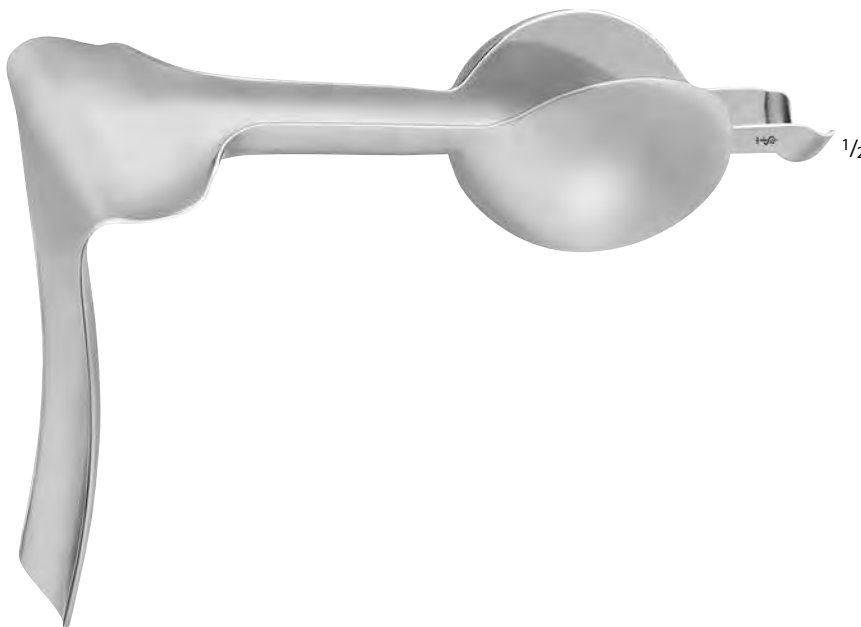

MB935R



EL859R-EL860R

DOYEN Lateral Speculum

Catalog Number	Blade Size (mm)	Length (in.)
EL859R	60 x 30	9
EL860R	80 x 30	9 3/4



EL740R-EL747R

SCHERBACK Vaginal Speculum Set

Catalog Number	Description	Blade Size (mm)
EL740R	SET COMPLETE	-
EL741R	BLADE	80 x 30
EL742R	BLADE	85 x 35
EL743R	BLADE	85 x 40
EL744R	BLADE	55 x 40
EL745R	BLADE	70 x 45
EL746R	HANDLE	-
EL747R	WEIGHT	-

EL740R Includes:
 1 Handle EL746R
 1 Weight EL747R
 4 Blades of each
 EL741R-EL744R



EL741R



EL742R



EL743R

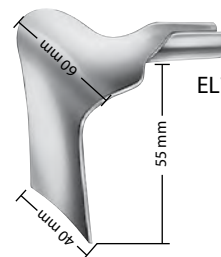

EL744R-EL745R

TUEBINGER Vaginal Retractor

Catalog Number	Blade Size (mm)	Length (in.)
EL868R	95 x 20	10 1/2

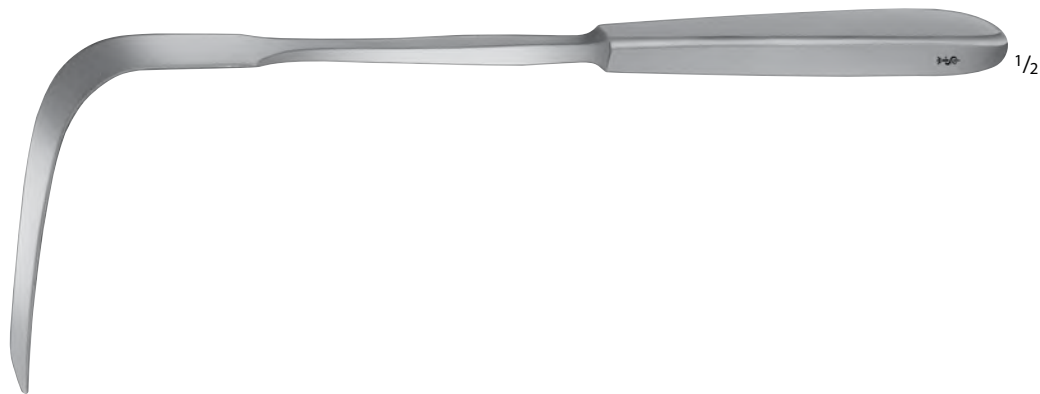

EL868R

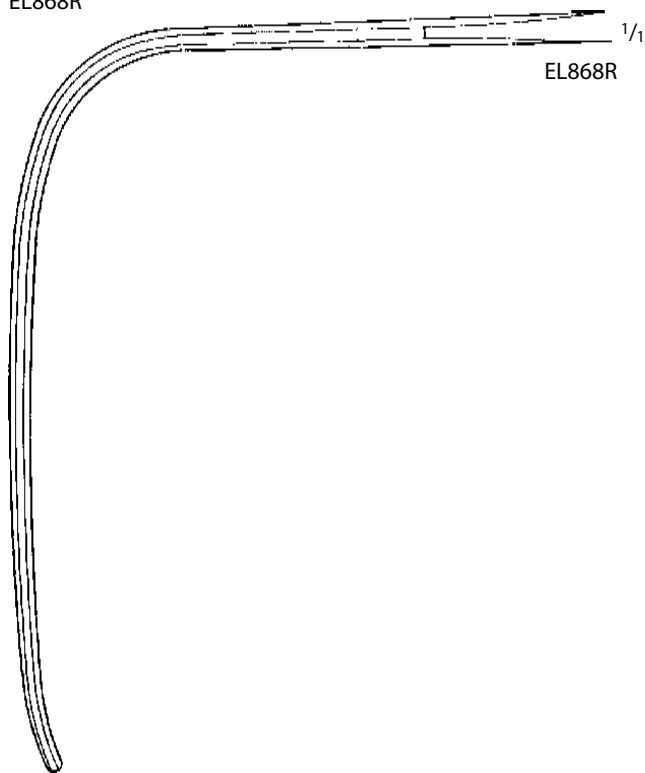

GLENNER Retractor

Catalog Number	Blade Size (mm)	Length (in.)
MG175R	135 x 25	10 5/8



MG175R

MARTIN Vaginal Retractor

Catalog Number	Blade Size (mm)	Length (in.)
EL870R	105 x 27	9 3/4

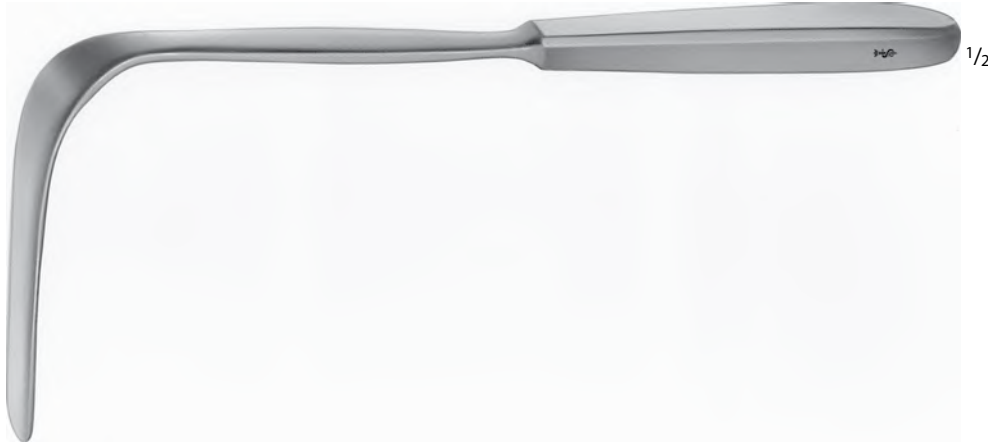

EL870R

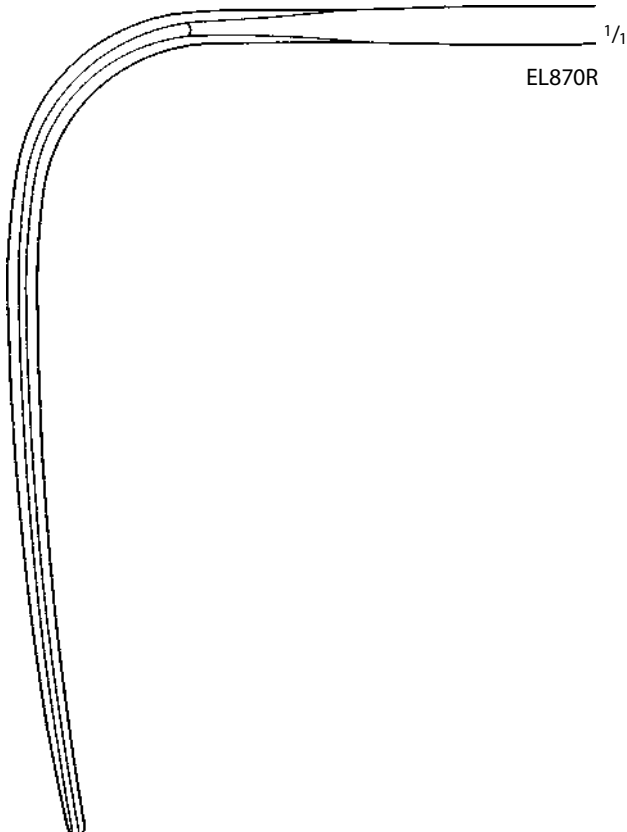

SIMON Vaginal Retractor

Catalog Number	Blade Size (mm)	Length (in.)
EL872R	115 x 22	10 3/4
EL873R	115 x 27	10 3/4



EL872R-EL872R

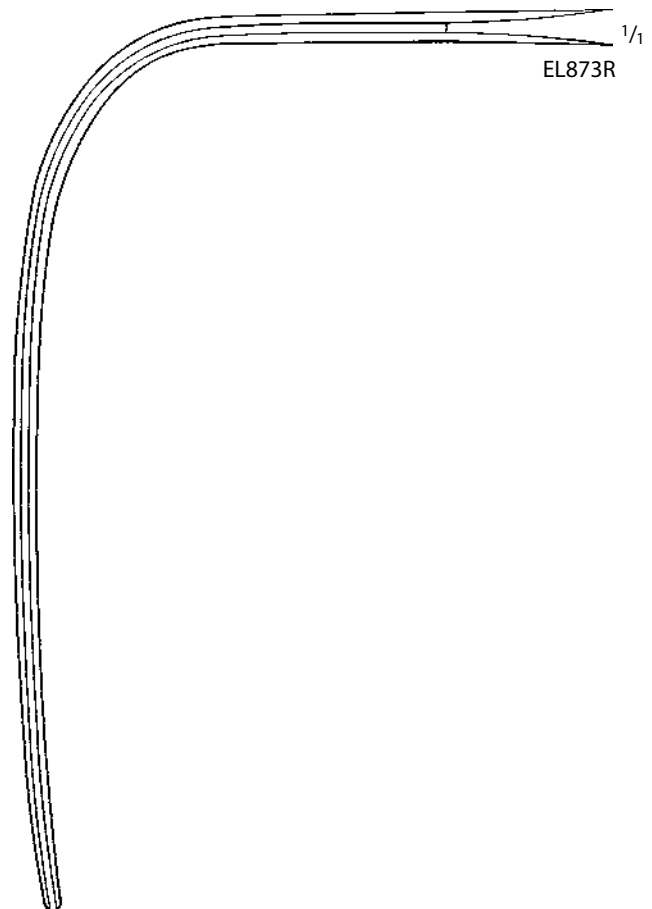
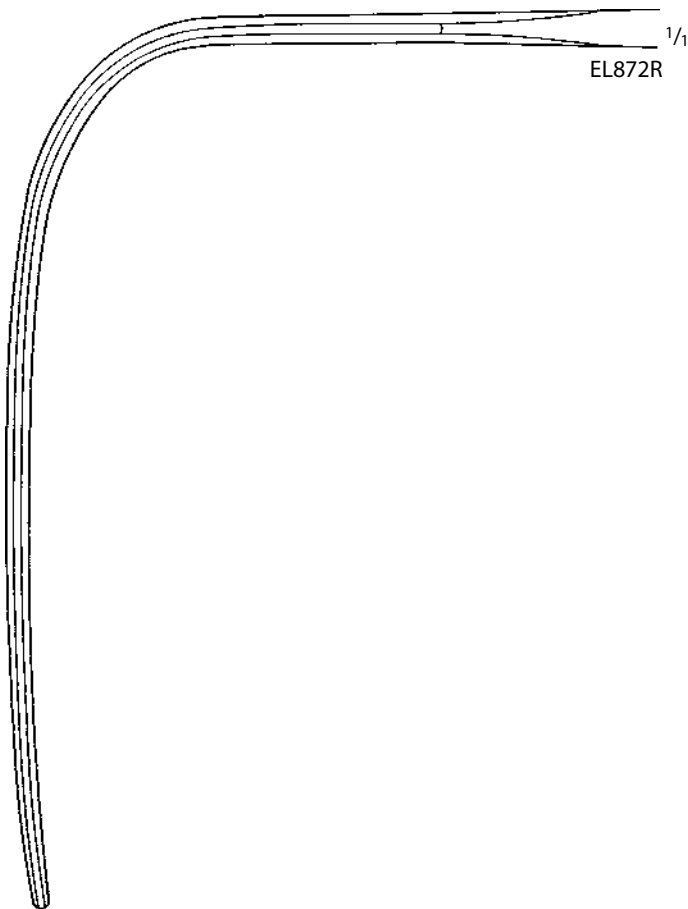

KOGAN Endospeculum

Catalog Number	Length (in.)
EM710R	9 1/2



EM710R

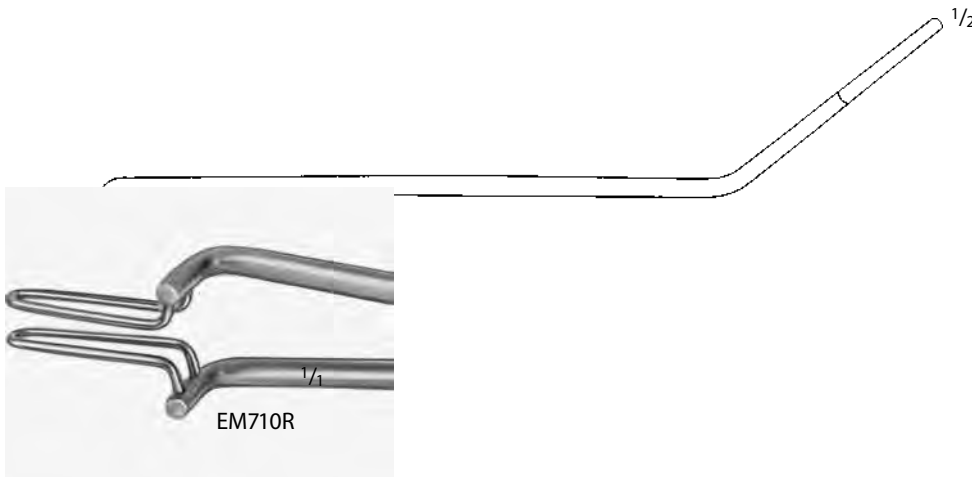

EM710R

KOGAN Cervix/Urethra Endospeculum,
 W/ Scale, Ratcheted

Catalog Number	Length (in.)
EM711R	9 1/2



EM711R



EM711R



EM101R-EM147R

HEGAR Dilator, Single Ended

Catalog Number	Tip Size (mm)	Length (in.)
EM101R	1	7 1/4
EM102R	2	7 1/4
EM103R	3	7 1/4
EM104R	4	7 1/4
EM105R	5	7 1/4
EM106R	6	7 1/4
EM107R	7	7 1/4
EM108R	8	7 1/4
EM109R	9	7 1/4
EM110R	10	7 1/4
EM111R	11	7 1/4
EM112R	12	7 1/4
EM113R	13	7 1/4
EM114R	14	7 1/4
EM115R	15	7 1/4
EM116R	16	7 1/4
EM117R	17	7 1/4
EM118R	18	7 1/4
EM119R	19	7 1/4
EM120R	20	7 1/4
EM121R	21	7 1/4
EM122R	22	7 1/4
EM123R	23	7 1/4
EM124R	24	7 1/4
EM125R	25	7 1/4
EM126R	26	7 1/4
EM131R	1.5	7 1/4
EM132R	2.5	7 1/4
EM133R	3.5	7 1/4
EM134R	4.5	7 1/4
EM135R	5.5	7 1/4
EM136R	6.5	7 1/4
EM137R	7.5	7 1/4
EM138R	8.5	7 1/4
EM139R	9.5	7 1/4
EM140R	10.5	7 1/4
EM141R	11.5	7 1/4
EM142R	12.5	7 1/4
EM143R	13.5	7 1/4
EM144R	14.5	7 1/4
EM145R	15.5	7 1/4
EM146R	16.5	7 1/4
EM147R	17.5	7 1/4



EM193R-EM194R

HEGAR Dilator Set, Single Ended

Catalog Number	Item
EM193R	SET W/ 14 DILATORS, 4-17 mm
EM194R	SET W/ 26 DILATORS, 1-26 mm

EM193R Includes:
EM097R Rack for Dilators 4-12 mm
EM098R Rack for Dilators 13-17 mm
JG161R Metal Case: 200 x 100 x 35 mm

Includes Dilators:
EM104R-EM117R

EM194R Includes:
EM099R Rack for Dilators 1-17 mm
EM100R Rack for Dilators 18-26 mm
JG170R Metal Case: 330 x 220 x 80 mm

Includes Dilators:
EM101R-EM126R



EM231R-EM244R

HEGAR Uterine Dilator, Double Ended

Catalog Number	Tip Size (mm)	Length (in.)
EM244R	SET OF 8	-
EM231R	1/2	7 3/4
EM232R	3/4	7 3/4
EM233R	5/6	7 3/4
EM234R	7/8	7 3/4
EM235R	9/10	7 3/4
EM236R	11/12	7 3/4
EM237R	13/14	7 3/4
EM238R	15/16	7 3/4
EM239R	17/18	7 3/4

Set Includes:
EM232R-EM239R

HEGAR Uterine Dilator, Slight Curved, Double Ended

Catalog Number	Tip Size (mm)	Length (in.)
MG270R	SET OF 8	-
MG251R	1/2	8
MG252R	3/4	8
MG253R	5/6	8
MG254R	7/8	8
MG255R	9/10	8
MG256R	11/12	8
MG257R	13/14	8
MG258R	15/16	8
MG259R	17/18	8

MG270R Set of 8 includes MG252R-MG259R



MG270R-MG259R

PRATT Uterine Dilator

Catalog Number	Tip Size (FR)	Length (in.)
EM270R	COMPLETE SET	-
EM271R	13/15	11 1/2
EM272R	17/19	11 1/2
EM273R	21/23	11 1/2
EM274R	25/27	11 1/2
EM275R	29/31	11 1/2
EM276R	33/35	11 1/2
EM277R	37/39	11 1/2
EM278R	41/43	11 1/2

EM270R Set of 8 includes EM271R-EM278R



EM270R-EM278R

HANK Dilator, French Scale

Catalog Number	Tip Size (FR)	Length (in.)
MD593R	COMPLETE SET	10
MD579R	9/10	10
MD594	11/12	10
MD595	13/14	10
MD596	15/16	10
MD597	17/18	10
MD598	19/20	10

MD593R Set of 6 includes MD579R, MD594-MD598



MD593R-MD598

HANK Dilator, American Scale

Catalog Number	Tip Size (mm)	Length (in.)
MD070R	COMPLETE SET	-
MD064R	9/10	10 3/4
MD065R	11/12	10 3/4
MD066R	13/14	10 3/4
MD067R	15/16	10 3/4
MD068R	17/18	10 3/4
MD069R	19/20	10 3/4

MD070R Set of 6 includes MD064R-MD069R



MD070R-MD069R

SIMS Uterine Probe, Graduated (cm)

Catalog Number	Tip	Tip Size (mm)	Blade	Length (in.)
EO010R	RGD	4	CVD	13
EO012R	MALL	4	CVD	13

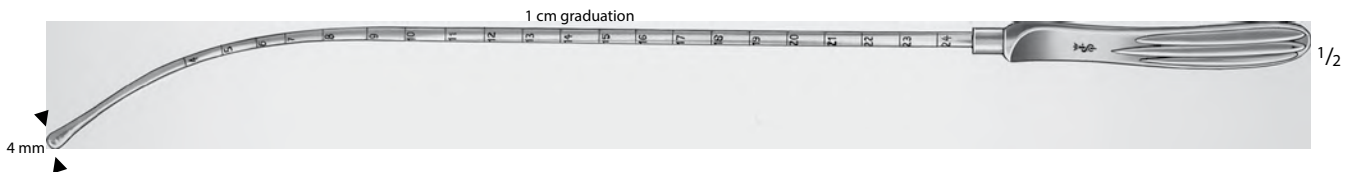

EO010R-EO012R

MARTIN Uterine Probe, Graduated (cm)

Catalog Number	Blade	Length (in.)
EO015R	CVD	11 3/4

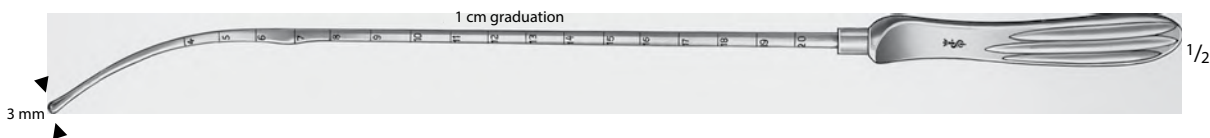

EO015R

VALLEIX Uterine Probe,
 Graduated (cm), W/ Slider

Catalog Number	Tip Size (mm)	Blade	Length (in.)
EO016R	4	CVD	9 3/4



EO016R

SIMPSON Uterine Probe,
 Graduated (cm)

Catalog Number	Tip	Tip Size (mm)	Blade	Length (in.)
EO020	MALL	4	CVD	12 1/4



EO020

BRAUN Uterine Depressor, Double Ended

Catalog Number	Blade Size (mm)	Length (in.)
EO030R	24/28	10 5/8



EO030R



ASCH Uterine Secretion Scoop,
 Malleable, Double Ended

Catalog Number	Length (in.)
ER005R	7 7/8

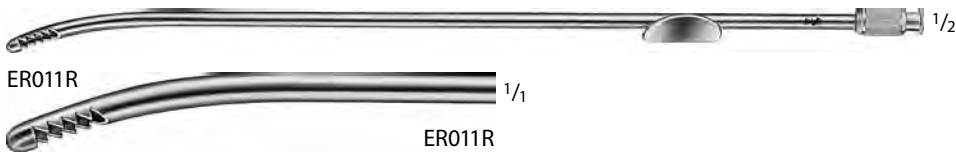

NOVAK Endometrial Biopsy Suction
 Curette

Catalog Number	Length (in.)
ER011R	9 1/2

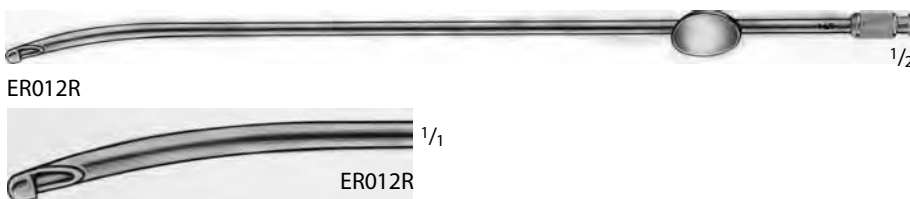

RANDALL Endometrial Suction and
 Biopsy Curette

Catalog Number	Length (in.)
ER012R	9 1/2



BERLIN Endometrial Biopsy Curette

Catalog Number	Tip Size (mm)	Length (in.)
ER015R	3.5	10 5/8

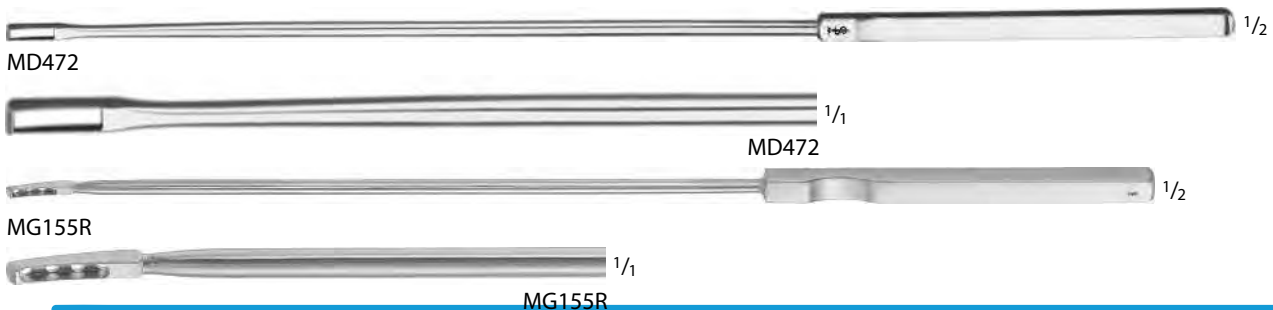

KEVORKIAN-YOUNGE Biopsy Curette

Catalog Number	Tip	Description	Length (in.)
MD472	SLIGHT-CVD	W/O Basket	13
MG155R	SLIGHT-CVD	W/ Basket	12 1/4

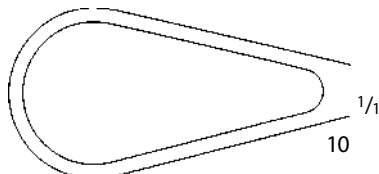
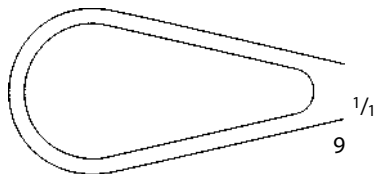
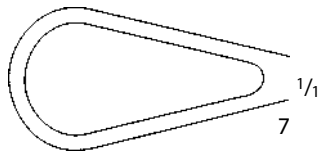
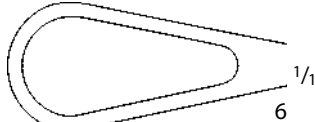
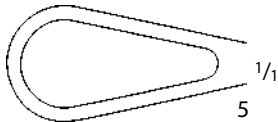
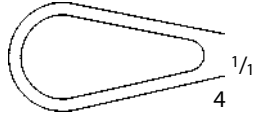
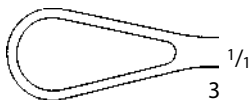
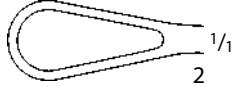
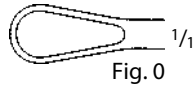
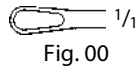
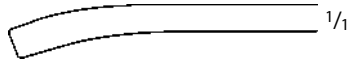

RECAMIER Uterine Curette

Catalog Number	Tip Size (#)	Tip Size (mm)	Tip	Length (in.)
ER219R	00	4.5	SHARP	11 3/4
ER220R	0	7.5	SHARP	11 3/4
ER221R	1	8.5	SHARP	11 3/4
ER222R	2	10.5	SHARP	11 3/4
ER223R	3	12.0	SHARP	11 3/4
ER224R	4	14.0	SHARP	11 3/4
ER225R	5	15.0	SHARP	11 3/4
ER226R	6	16.5	SHARP	11 3/4
ER227R	7	18.0	SHARP	11 3/4
ER228R	8	19.5	SHARP	11 3/4
ER229R	9	21.5	SHARP	11 3/4
ER230R	10	23.5	SHARP	11 3/4
ER241R	1	8.5	SHARP/MALL	11 3/4
ER242R	2	10.5	SHARP/MALL	11 3/4
ER243R	3	12.0	SHARP/MALL	11 3/4
ER244R	4	14.0	SHARP/MALL	11 3/4
ER245R	5	15.0	SHARP/MALL	11 3/4
ER246R	6	16.5	SHARP/MALL	11 3/4
ER247R	7	18.0	SHARP/MALL	11 3/4
ER248R	8	19.5	SHARP/MALL	11 3/4
ER320R	0	7.5	BLUNT	11 3/4
ER321R	1	8.5	BLUNT	11 3/4
ER322R	2	10.5	BLUNT	11 3/4
ER323R	3	12.0	BLUNT	11 3/4
ER324R	4	14.0	BLUNT	11 3/4
ER325R	5	15.0	BLUNT	11 3/4
ER326R	6	16.5	BLUNT	11 3/4
ER327R	7	18.0	BLUNT	11 3/4
ER328R	8	19.5	BLUNT	11 3/4
ER329R	9	21.5	BLUNT	11 3/4
ER330R	10	23.5	BLUNT	11 3/4
ER611R	1	34.5	BLUNT	14 1/4
ER612R	2	39.5	BLUNT	14 1/4



ER611R-ER612R

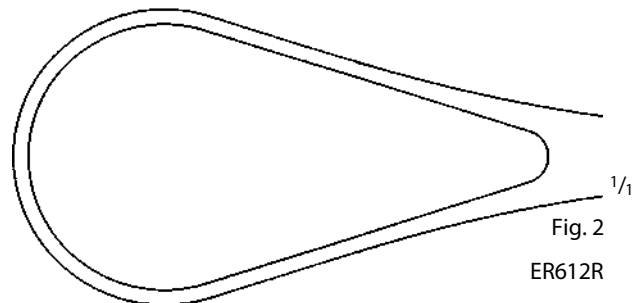
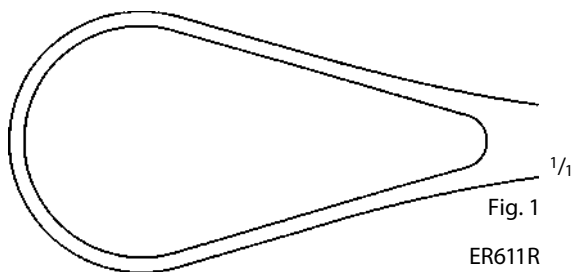

SIMS Uterine Curette

Catalog Number	Tip Size (#)	Tip Size (mm)	Tip	Length (in.)
ER401R	1	7.5	SHARP	10
ER402R	2	8.5	SHARP	10
ER403R	3	10.5	SHARP	10
ER404R	4	12.0	SHARP	10
ER405R	5	14.0	SHARP	10
ER406R	6	15.0	SHARP	10
ER411R	1	7.5	SHARP/MALL	10
ER412R	2	8.5	SHARP/MALL	10
ER413R	3	10.5	SHARP/MALL	10
ER414R	4	12.0	SHARP/MALL	10
ER415R	5	14.0	SHARP/MALL	10
ER416R	6	15.0	SHARP/MALL	10
ER421R	1	7.5	BLUNT	10
ER422R	2	8.5	BLUNT	10
ER423R	3	10.5	BLUNT	10
ER424R	4	12.0	BLUNT	10
ER425R	5	14.0	BLUNT	10
ER426R	6	15.0	BLUNT	10
MG140R	000	4.5	SHARP/MALL	11
MG141R	00	5.6	SHARP/MALL	11
MG142R	0	6.2	SHARP/MALL	11
MG143R	1	7.3	SHARP/MALL	11
MG144R	2	8.5	SHARP/MALL	11
MG145R	3	9.4	SHARP/MALL	11
MG146R	4	10.6	SHARP/MALL	11
MG147R	5	11.5	SHARP/MALL	11
MG148R	6	12.6	SHARP/MALL	11



ER401R-MG148R

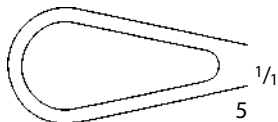
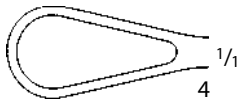
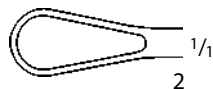

ER401R-ER426R

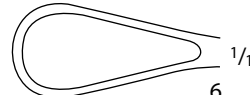
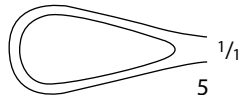
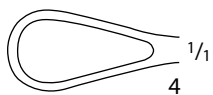
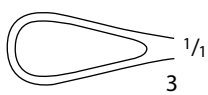
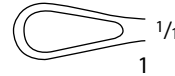
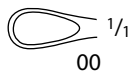
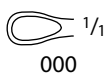

MG140R-MG148R

Let Us know if you could not find what you are looking for

BUMM Uterine Curette, Blunt
 Malleable

Catalog Number	Tip Size (#)	Tip Size (mm)	Length (in.)
ER520R	0	16.0	11 1/2
ER521R	1	18.0	11 1/2
ER522R	2	19.5	11 1/2
ER523R	3	21.5	11 1/2
ER524R	4	23.5	11 1/2
ER525R	5	26.0	11 1/2
ER526R	6	28.5	11 1/2



ER520R-ER526R

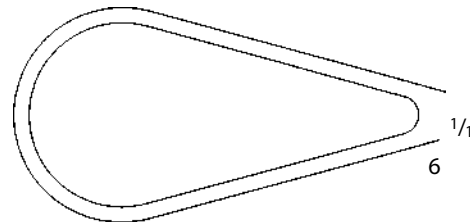
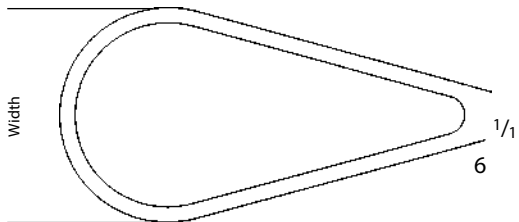
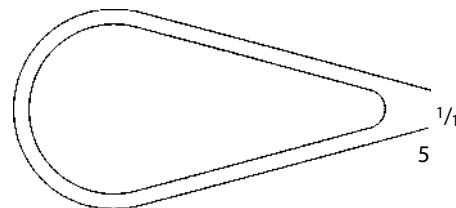
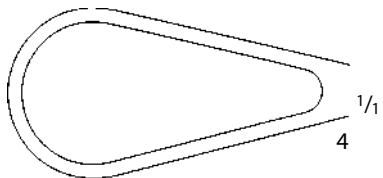
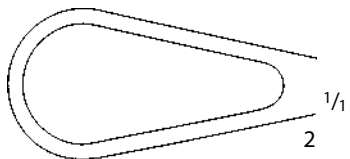
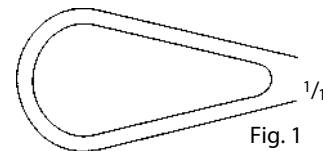
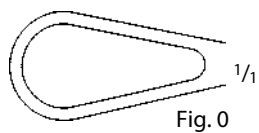

Let Us know if you could not find what you are looking for

SIMS THOMAS Uterine Curette,
 Blunt/Malleable

Catalog Number	Tip Size (#)	Tip Size (mm)	Length (in.)
MG149R	0	6.0	11
ER211R	1	8.5	11
ER212R	2	10.5	11
ER213R	3	12.0	11
ER214R	4	14.0	11
ER215R	5	15.0	11
ER216R	6	16.5	11



MG149R-ER216R

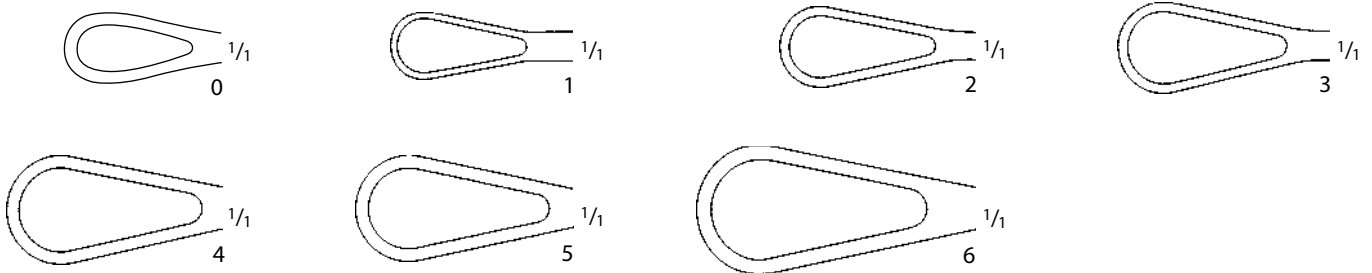

KELLY-GRAY Uterine Curette

Catalog Number	Tip Size (#)	Tip Size (mm)	Length (in.)
MB375R	1	5.0	9 1/2
MB376R	2	6.0	9 1/2
MB377R	3	7.5	9 1/2
MB378R	4	8.5	9 1/2



MB375R-MB378R



HEANEY Uterine Curette, Malleable

Catalog Number	Tip	Length (in.)
ER025R	TOOTHED	9 1/2



ER025R



ER025R

COLLIN Uterine Curette, Rigid

Catalog Number	Tip	Length (in.)
ER580R	TOOTHED	11 3/4



ER580R



ER580R

BLAKE Uterine Curette, Double Ended

Catalog Number	Tip	Length (in.)
ER585R	SHARP/BLUNT	10 3/4



ER585R

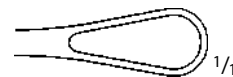
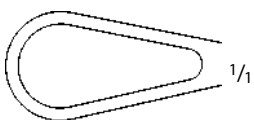

ER585R

BUMM Uterine Curette

Catalog Number	Tip Size (#)	Tip Size (mm)	Tip	Length (in.)
ER621R	1	23.5	SHARP/MALL	12 1/4
ER623R	3	28.5	SHARP/MALL	12 1/4
ER626R	1	23.5	BLUNT/MALL	12 1/4
ER627R	2	26.0	BLUNT/MALL	12 1/4
ER628R	3	28.5	BLUNT/MALL	12 1/4



ER621R-ER628R

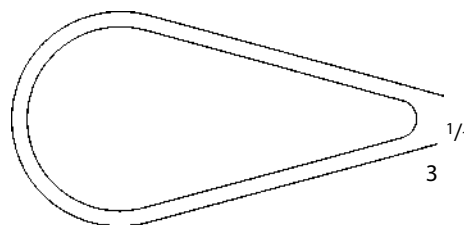
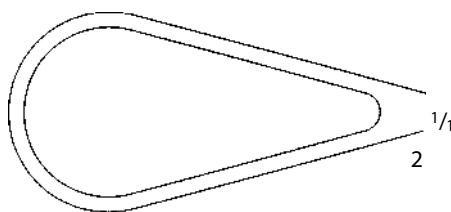
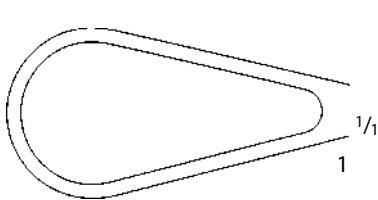

WALLICH Placenta/Ovum Scoop

Catalog Number	Tip	Length (in.)
ER602R	CVD	16 3/4



ER602R

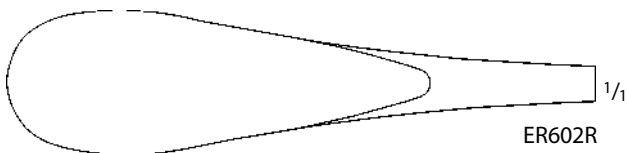
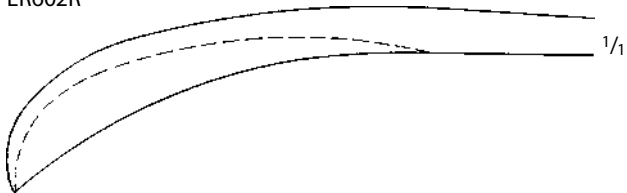

ER602R



ET096R

1/2



SR580R

1/2

Guide Sheath, IOWA Trumpet

Catalog Number	Tip Size (mm)	Description	Length (in.)
ET096R	—	—	6 7/8
SR580R	1 x 185	INJECTION NEEDLE, LUER-LOCK HUB	—

Uterine Cannula W/ 2 Cones

Catalog Number	Length (in.)
ER876	13 3/4

Cones:

- 1 ER876201 (small)
- 1 ER876202 (large)



ER876

1/3

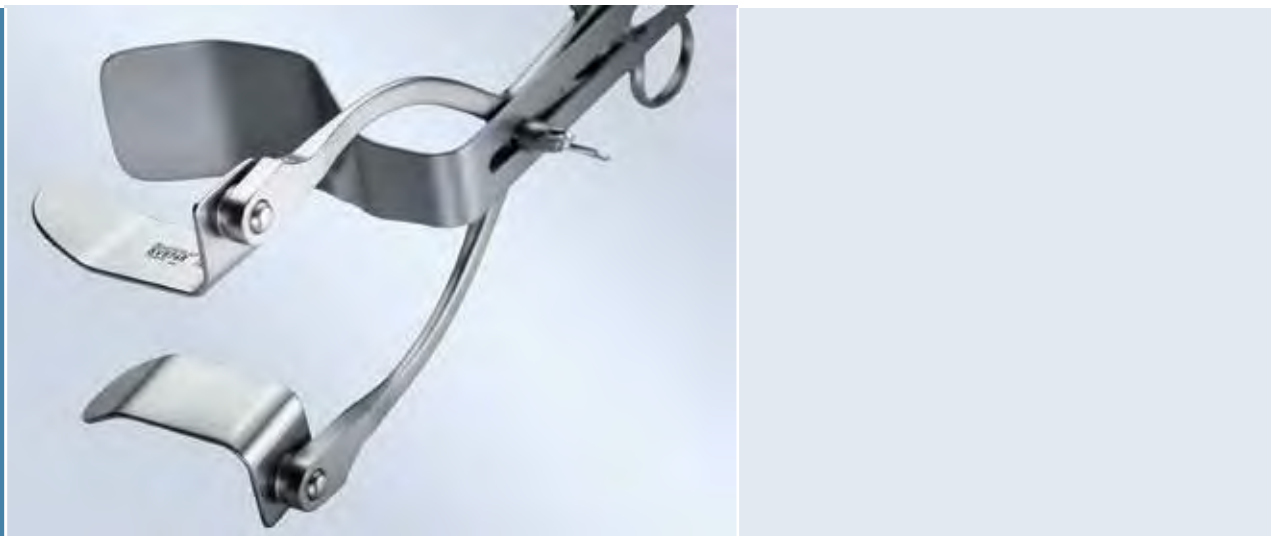

Urology

Needles	1298
Instruments for Radical Prostatectomy	1299 - 1302
Forceps and Clamps	1303 - 1313
Retractors	1314 - 1318
Catheters, Guides and Sounds	1319 - 1322



BM711R-BM714R



BM711R



BM711R



BM712R



BM713R



BM714R



BM726R-BM729R



BM726R

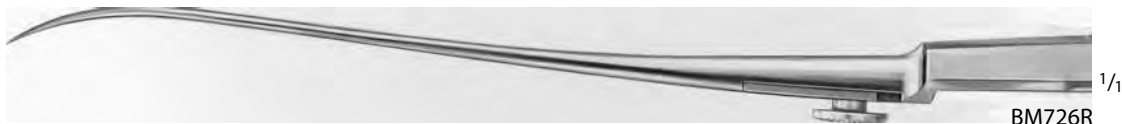

BM726R



BM727R



BM728R



BM729R

REVERDIN Needle

Catalog Number	Tip	Length (in.)
BM711R	SLIGHT-CVD	7 3/4
BM712R	CVD	7 3/4
BM713R	HEAVY-CVD	7 3/4
BM714R	X-HEAVY-CVD	7 3/4
BM726R	SLIGHT-CVD	9
BM727R	CVD	9
BM728R	HEAVY-CVD	9
BM729R	X-HEAVY-CVD	9

BARRÉ Scalpel Handle #3L, F/ Blade nos. 10-15, 40, 42

Catalog Number	Blade Shape	Blade Angle	Length (in.)
BB176R	ANG	12°	9 3/4



BB176R



BB176R

BARRÉ Scalpel Handle #3XL, F/ Blade nos. 10-15, 40, 42

Catalog Number	Blade Shape	Length (in.)
BB177R	STR	9 3/4



BB177R



BB177R

BARRÉ Scalpel Handle #3XL, F/ Blade nos. 10-15, 40, 42

Catalog Number	Blade Shape	Blade Angle	Length (in.)
BB178R	ANG	25°	9 3/4



BB178R



BB178R



EF167R

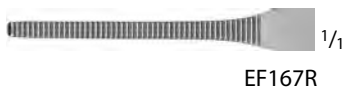

EF167R

Dorsal Venous Complex Clamp

Catalog Number	Blade Angle	Length (in.)
EF167R	10°	8 1/4

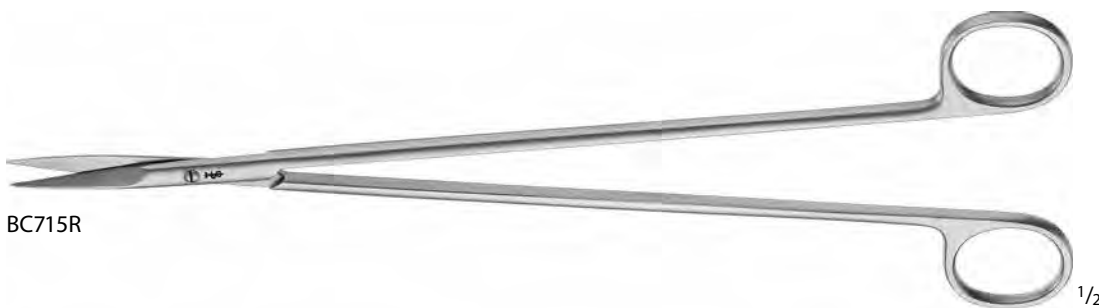

BC715R

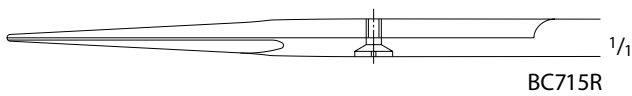

BC715R

BARRÉ Nerve Sparing Scissors

Catalog Number	Tip	Blade Shape	Length (in.)
BC715R	S/S	CVD	11

BARRÉ Nerve Sparing Dissector

Catalog Number	Tip	Length (in.)
BJ029R	X-FINE	11
BJ110R	FINE	11

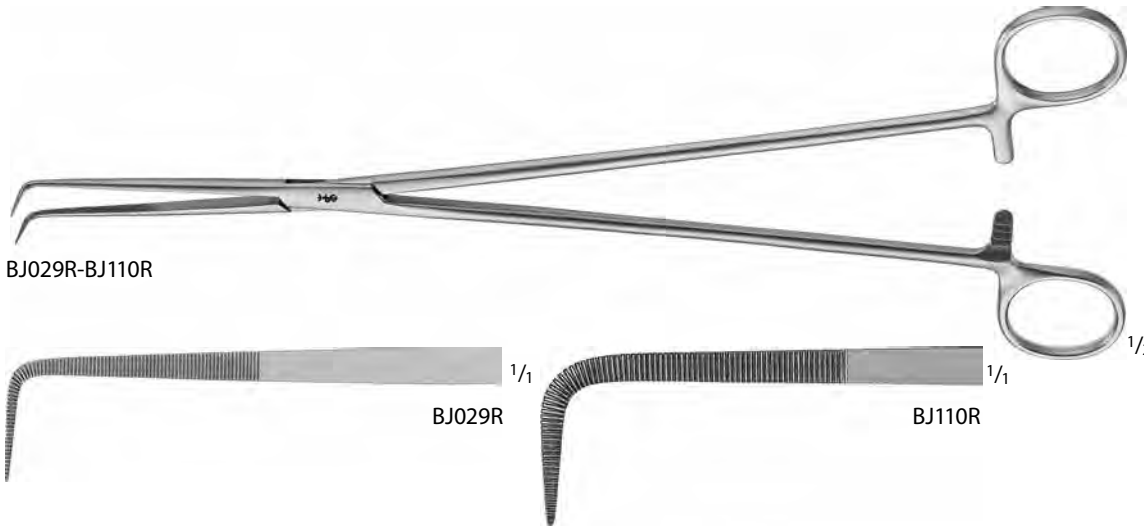

BJ029R-BJ110R

BJ029R

BJ110R

BARRÉ Prostate Retractor

Catalog Number	Length (in.)
BT680R	14 1/4



BT680R

BARRÉ Urethra Retractor

Catalog Number	Tip	Length (in.)
BT682R	SMALL	10 1/4
BT683R	LARGE	10 1/4
BT681R	—	15 3/8



BT681R

BARRÉ Suture Holding Frame

Catalog Number	Length (in.)
BV927R	18 1/4



BV927R



BV921



BV922



BV840



BV849



BV925



BV924



BV926

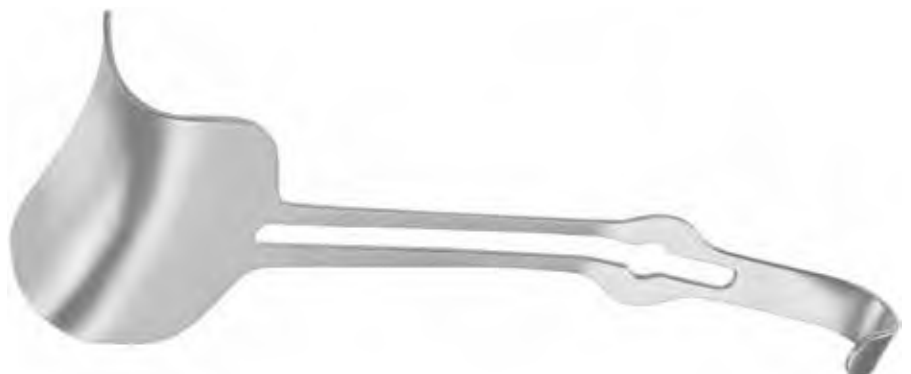

BV929

BARRÉ Prostatectomy Retractor

Catalog Number	Description	Blade Size, Depth x Width (in.)	Length (in.)
BV921R	COMPLETE RETRACTOR SYSTEM	-	
BV922R	RETRACTOR ONLY	-	
BV840R	MUENSTER OCTANGULAR NOTCH ROD	-	7 7/8
BV849R	MUENSTER UNIVERSAL CONNECTING CLAMP	-	2 3/8
BV925R	BARRÉ COLD LIGHT SUPPORT	-	
BV924R	BARRÉ RETRACTOR BLADES PAIR OF BLADES 2" DEPTH x 2 1/4" WIDTH	2 x 2 3/4	
BV926R	LATERAL BLADE MALLEABLE 2" DEPTH x 7 1/2" WIDTH	2 x 7 1/2	7 1/2
BV929R	CENTER BLADE 2 1/4" DEPTH x 2 3/4" WIDTH	2 1/4 x 2 3/4	9 1/4

BV921R Full Set includes:

- BV922R
- BV840R
- BV849R
- BV925R
- BV924R
- BV926R
- BV929R



GUYON Atraumatic Kidney Clamp

Catalog Number	Length (in.)
EF002R	9
EF001R	9 1/2

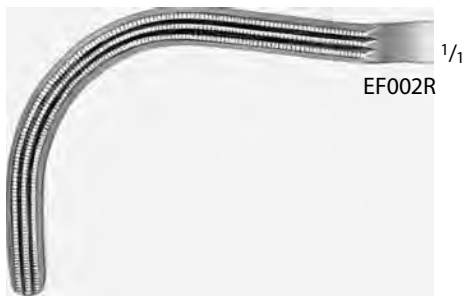



EF011R-EF012R

GUYON Kidney Clamp

Catalog Number	Length (in.)
EF011R	9
EF010R	9 1/4
EF012R	11



EF011R



EF010R

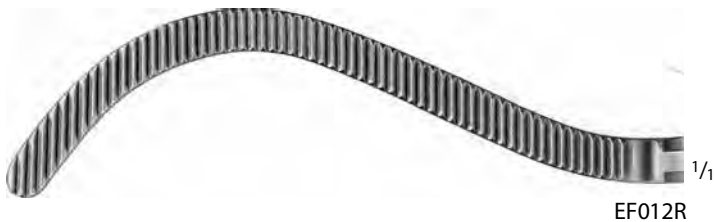

EF012R

STILLE Kidney Clamp

Catalog Number	Length (in.)
EF016R	8 7/8
EF015R	9 1/2



EF016R-EF015R

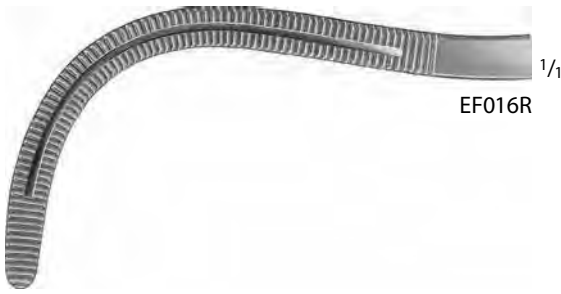

EF016R

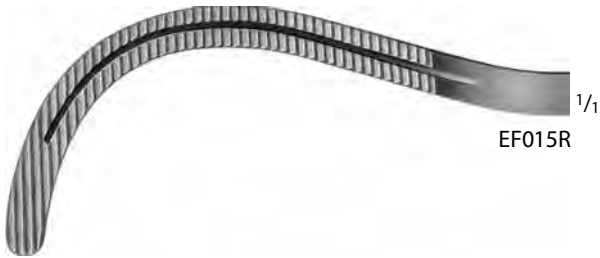

EF015R



EF030R

HERRICK Kidney Clamp

Catalog Number	Length (in.)
EF030R	8 7/8

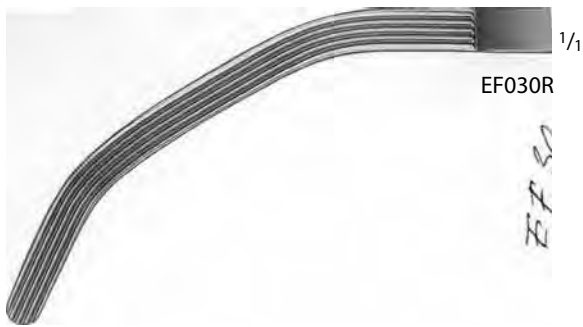

EF030R

Ureter Atraumatic Forceps

Catalog Number	Length (in.)
EF070R	9 1/2



EF070R



EF070R

HEIMING Kidney Stone Forceps

Catalog Number	Jaw	Length (in.)
EF047R	SLIGHT-CVD	6 3/4
EF048R	HEAVY-CVD	6 1/4

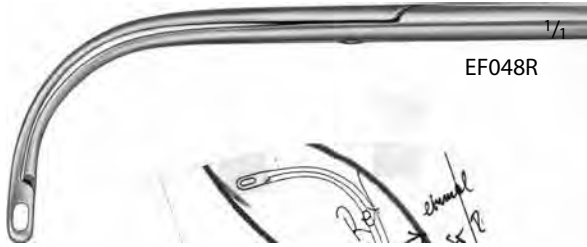

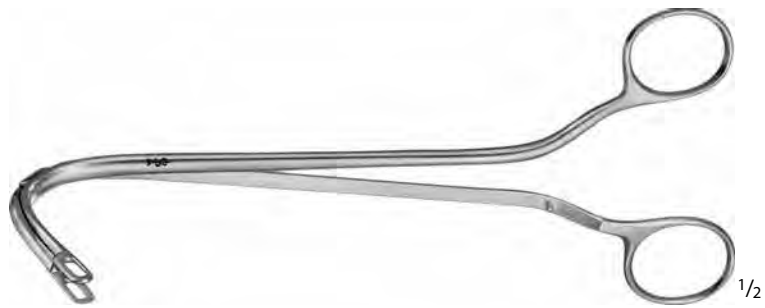

EF055R-EF056R

RANDALL Kidney Stone Forceps

Catalog Number	Jaw	Length (in.)
EF055R	CVD	7 1/2
EF056R	HEAVY-CVD	7 1/2

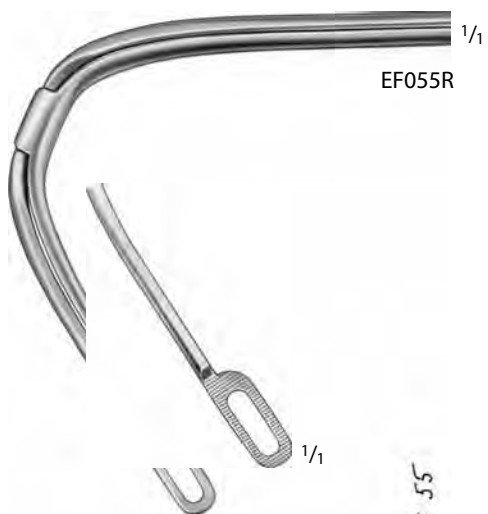

EF055R



EF056R

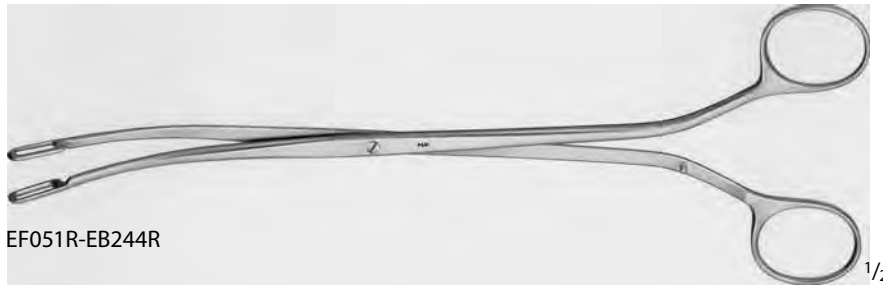

RANDALL Kidney Stone Forceps
 (continued)

Catalog Number	Jaw	Length (in.)
EF051R	SLIGHT-CVD	8 7/8
EF052R	CVD	8 7/8
EF053R	HEAVY-CVD	8 7/8
EB246R	HEAVY CVD, VERY DELICATE	9
EF054R	U-CVD	8 7/8
EB244R	90° ANG	9 5/8

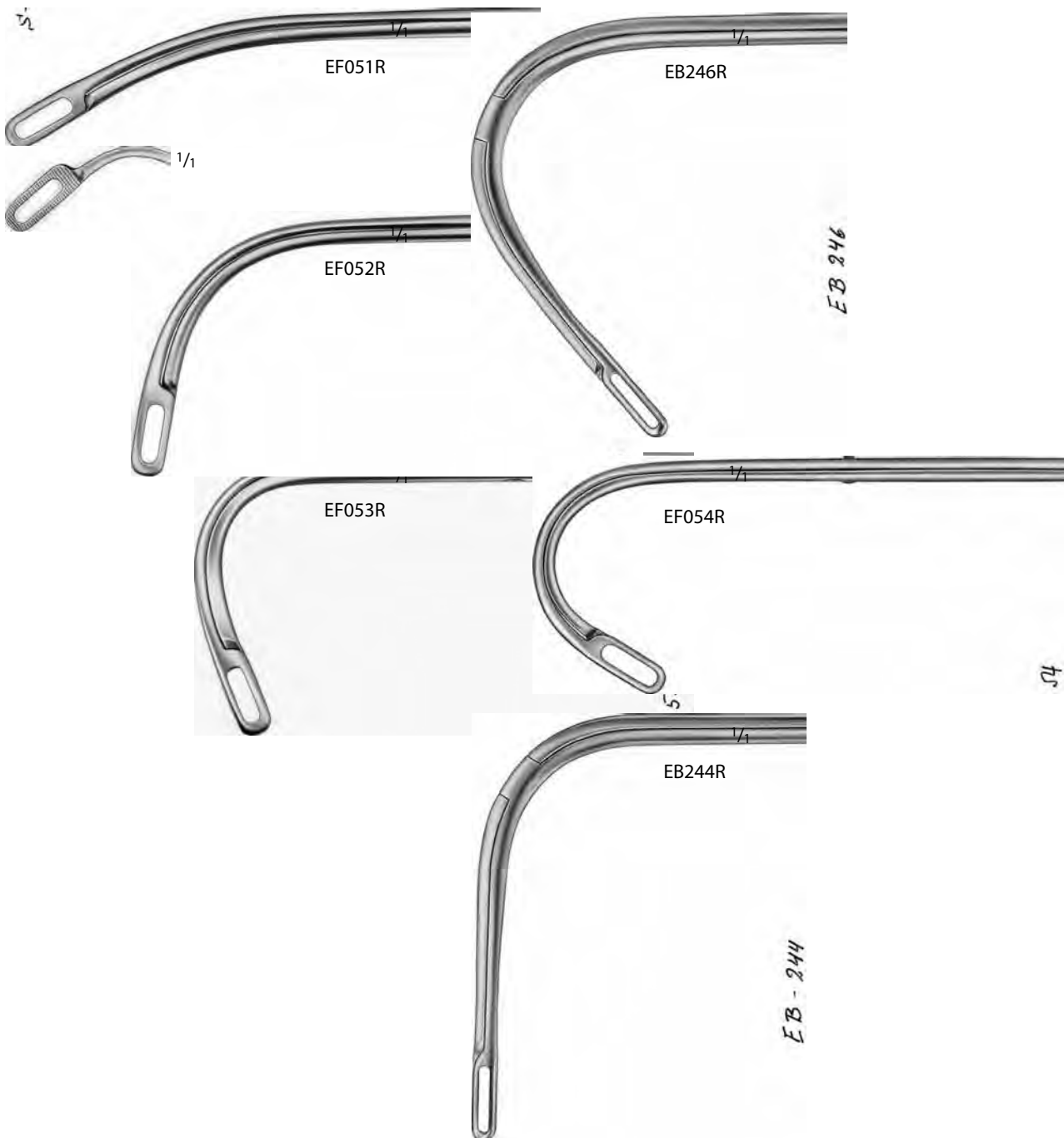

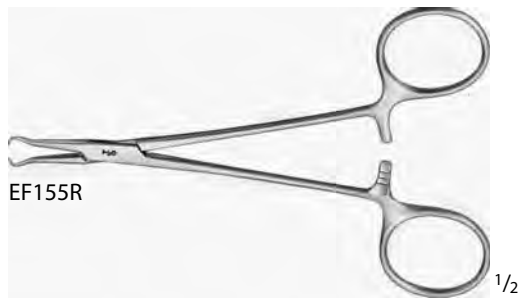

Genitourinary Forceps (F/ No Scalpel Set)

Catalog Number	Length (in.)
EF155R	5



MILLIN Atraumatic Lobe Forceps

Catalog Number	Length (in.)
EF163R	9 5/8

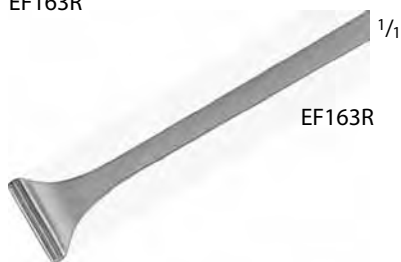

MILLIN Atraumatic T-Shaped Lobe Forceps

Catalog Number	Length (in.)
EF164R	9 1/4

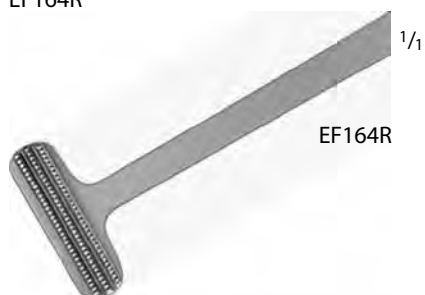

MATHIEU Foreign Body Forceps

Catalog Number	Shaft Length (in.)
EF928R	7 1/2

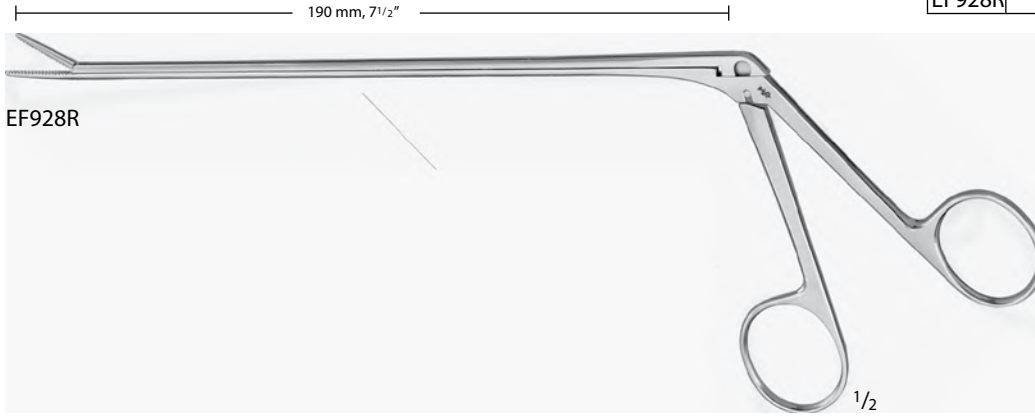

Spermatic Cord Fixation Clamp

Catalog Number	Length (in.)
EF195R	5 3/4



LEADER Vas Isolation Forceps

Catalog Number	Length (in.)
MG452R	5 1/4



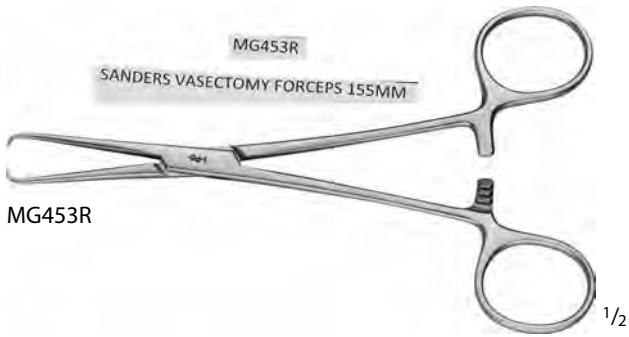

MG453R

1/2



1/1

MG453R

SANDERS Vasectomy Forceps

Catalog Number	Tip	Length (in.)
MG453R	1 x 1 PRONGS	6 1/8



EF400R

1/2

STOCKMANN Penis Clamp

Catalog Number	Length (in.)
EF400R	2 3/4



EF401R

1/2

STRAUSS Penis Clamp

Catalog Number	Length (in.)
EF401R	5 1/8



MG207R

ZIPSER Meatus Clamp

Catalog Number	Length (in.)
MG207R	4 1/4



EF965R-EF967R

WINKELMANN Circumcision Clamp

Catalog Number	Diameter (mm)
EF965R	12
EF966R	16
EF967R	20

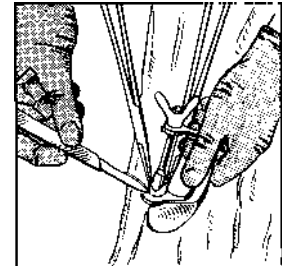
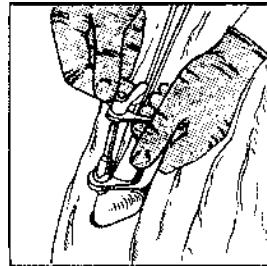

Assisted by two hemostats or ligatures the foreskin is pushed over the bell-shaped protection rod and the glans is placed into it. Next, the wing-nut is tightened as close as possible, so the foreskin is annular compressed. The foreskin is cut off with a scalpel adjacent to the compression ring. The circumcision clamp remains in place for a few minutes to avoid bleeding. If any large vein, specially the frenular artery, is cut, a ligature must be set. The advantage of the method described is the cosmetically favorable scar which is left after rejection of the small necrotized portion.

LOWSLEY Prostatic Tractor

Catalog Number	Tip	Tip Size (FR)	Working Length (in.)	Length (in.)
MG080R	STR	20	9	12 1/4
MG079R	CVD	20	9 1/2	12 3/4



MG080R-MG079R



MG080R-MG079R



MG250R

YOUNG Prostatic Tractor, Short

Catalog Number	Tip Size (mm)	Length (in.)
MG250R	25 x 25	8 5/8



MG250R

LEGUEU Bladder Spatula Retractor

Catalog Number	Blade Size (mm)	Length (in.)
BV928R	35 / 90	10 1/4



BV928R

WYLIE Renal Vein Retractor

Catalog Number	Blade Size (mm)	Length (in.)
MG179R	25 x 100	13 3/4
MG066R	25 x 175	12 3/4



MG066R-MG179R

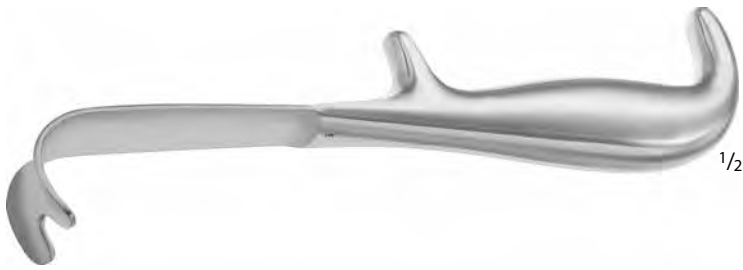

MG248R

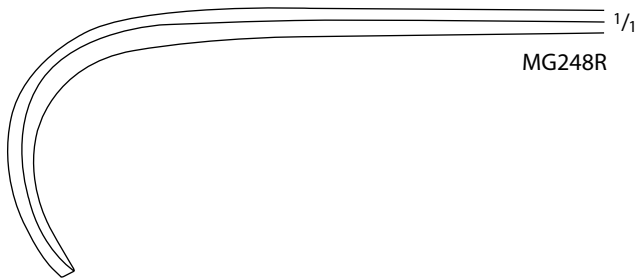

MG248R

YOUNG Bulb Retractor

Catalog Number	Blade Size (mm)	Length (in.)
MG248R	25 x 25	8 5/8

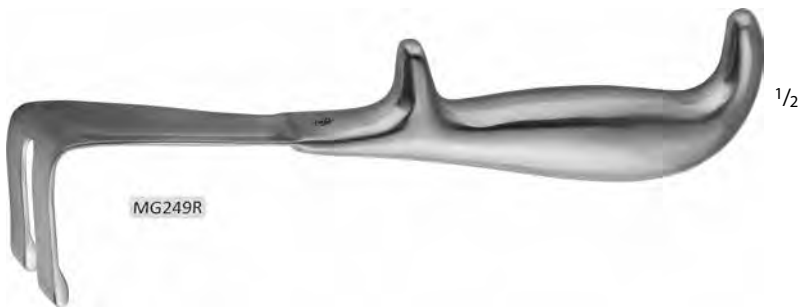

MG249R

YOUNG Prostatic Retractor, Bifurcated
 Blade W/ Deep Slots

Catalog Number	Blade Size (mm)	Length (in.)
MG249R	1 1/2 x 1 5/8	7 7/8

YOUNG Lateral Retractor

Catalog Number	Blade Size (mm)	Length (in.)
MG180R	50 x 11	8 1/4



MG180R

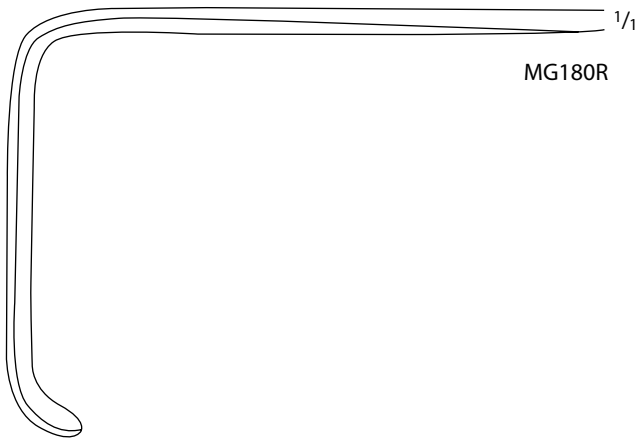

MG180R

YOUNG Anterior Retractor

Catalog Number	Blade Size (mm)	Length (in.)
MG181R	60 x 40	7 5/8

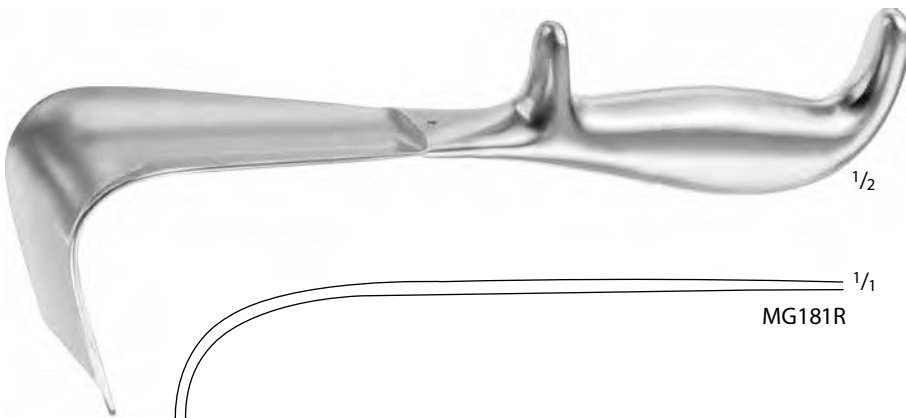

MG181R



MG181R



BT210R-BT217R

GIL VERNET Vein Retractor

Catalog Number	Blade Size (mm)	Length (in.)
BT210R	10 x 4	9 1/2
BT211R	10 x 6	9 1/2
BT212R	10 x 8	9 1/2
BT213R	10 x 11	9 1/2
BT214R	13 x 15	9 1/2
BT215R	13 x 17	9 1/2
BT216R	14 x 20	9 1/2
BT217R	16 x 23	9 1/2



BV580R-BV578R

MILLIN Bladder Retractor

Catalog Number	Description
BV580R	COMPLETE SET
BV575R	SPREADER
BV576R	BLADES, 57 x 25 MM
BV577R	BLADES, 82 x 25 MM
BV578R	CENTER BLADE, 105 x 45 MM

BV580R Includes:
 1 Spreader BV575R
 1 Center Blade BV578R
 2 Blades of each BV576R and BV577R

Let Us know if you could not find what you are looking for

Female Catheter, Metal

Catalog Number	Tip Size (FR)	Length (in.)
EF306C	6	6 1/4
EF308C	8	6 1/4
EF310C	10	6 1/4
EF312C	12	6 1/4
EF314C	14	6 1/4
EF316C	16	6 1/4
EF318C	18	6 1/4



EF306C-EF318C

GUYON Wire Catheter Guide, Rigid

Catalog Number	Blade	Tip Size (FR)	Length (in.)
EF492R	CVD	7	14 3/8



EF492R

JEWETT Urethral Sound

Catalog Number	Tip Size (FR)	Shape	Length (in.)
MG240R	12	STR	9 1/2
MG241R	14	STR	9 1/2
MG242R	16	STR	9 1/2
MG243R	18	STR	9 1/2
MG244R	20	STR	9 1/2
MG245R	22	STR	9 1/2
MG246R	24	STR	9 1/2
MG247R	26	STR	9 1/2
MG128R	28	STR	9 1/2
MG129R	30	STR	9 1/2
MG130R	32	STR	9 1/2



MG240R-MG130R



EF638R-EF660R

DITTEL Urethral Sound

Catalog Number	Tip Size (FR)	Length (in.)
EF638R	8	13 1/2
EF639R	9	13 1/2
EF640R	10	13 1/2
EF641R	11	13 1/2
EF642R	12	13 1/2
EF643R	13	13 1/2
EF644R	14	13 1/2
EF645R	15	13 1/2
EF646R	16	13 1/2
EF647R	17	13 1/2
EF648R	18	13 1/2
EF649R	19	13 1/2
EF650R	20	13 1/2
EF651R	21	13 1/2
EF652R	22	13 1/2
EF653R	23	13 1/2
EF654R	24	13 1/2
EF655R	25	13 1/2
EF656R	26	13 1/2
EF657R	27	13 1/2
EF658R	28	13 1/2
EF659R	29	13 1/2
EF660R	30	13 1/2



MG131R-MG139R

CAMPBELL Miniature Sound

Catalog Number	Tip Size (FR)	Length (in.)
MG131R	6	9 1/2
MG132R	8	9 1/2
MG133R	10	9 1/2
MG134R	12	9 1/2
MG135R	14	9 1/2
MG136R	16	9 1/2
MG137R	18	9 1/2
MG138R	20	9 1/2
MG139R	22	9 1/2



MB805R-MB884R

MCCREA Urethral Sound, Infant/Female

Catalog Number	Tip Size (FR)	Length (in.)
MB805R	8	7 1/4
MB806R	10	7 1/4
MB809R	12	7 1/4
MB810R	14	7 1/4
MB811R	16	7 1/4
MB813R	18	7 1/4
MB814R	20	7 1/4
MB815R	22	7 1/4
MB838R	24	7 1/4
MB839R	26	7 1/4
MB840R	28	7 1/4
MB881R	30	7 1/4
MB882R	32	7 1/4
MB883R	34	7 1/4
MB884R	36	7 1/4

VAN BUREN Urethral Sound

Catalog Number	Tip Size (FR)	Length (in.)
EF800R	8	10 5/8
EF801R	10	10 5/8
EF802R	12	10 5/8
EF803R	14	10 5/8
EF804R	16	10 5/8
EF805R	18	10 5/8
EF806R	20	10 5/8
EF807R	22	10 5/8
EF808R	24	10 5/8
EF809R	26	10 5/8
EF810R	28	10 5/8
EF811R	30	10 5/8
EF812R	32	10 5/8
EF813R	34	10 5/8
EF814R	36	10 5/8
EF815R	38	10 5/8
EF816R	40	10 5/8



EF800R-EF816R



MB158R-MB169R

WALTHER Dilator-Catheter

Catalog Number	Tip Size (FR)	Length (in.)
MB158R	12	5 1/4
MB170R	14	5 1/4
MB173R	16	5 1/4
MB159R	18	5 1/4
MB160R	20	5 1/4
MB161R	22	5 1/4
MB162R	24	5 1/4
MB163R	26	5 1/4
MB164R	28	5 1/4
MB165R	30	5 1/4
MB166R	32	5 1/4
MB167R	34	5 1/4
MB168R	36	5 1/4
MB169R	38	6

OTIS Bougies a Boule, Olive Tip

Catalog Number	Tip Size (FR)	Length (in.)
MG111R	8	10
MG112R	10	10
MG113R	12	10
MG114R	14	10
MG115R	16	10
MG116R	18	10
MG117R	20	10
MG118R	22	10
MG119R	24	10
MG120R	26	10
MG121R	28	10
MG122R	30	10
MG123R	32	10
MG124R	34	10
MG125R	36	10
MG126R	38	10
MG127R	40	10



MG111R-MG127R





Thank You

sales@healermedinstruments.com

+92 303 451 51 51

www.healermedinstruments.com
